

A History of RepRap Development

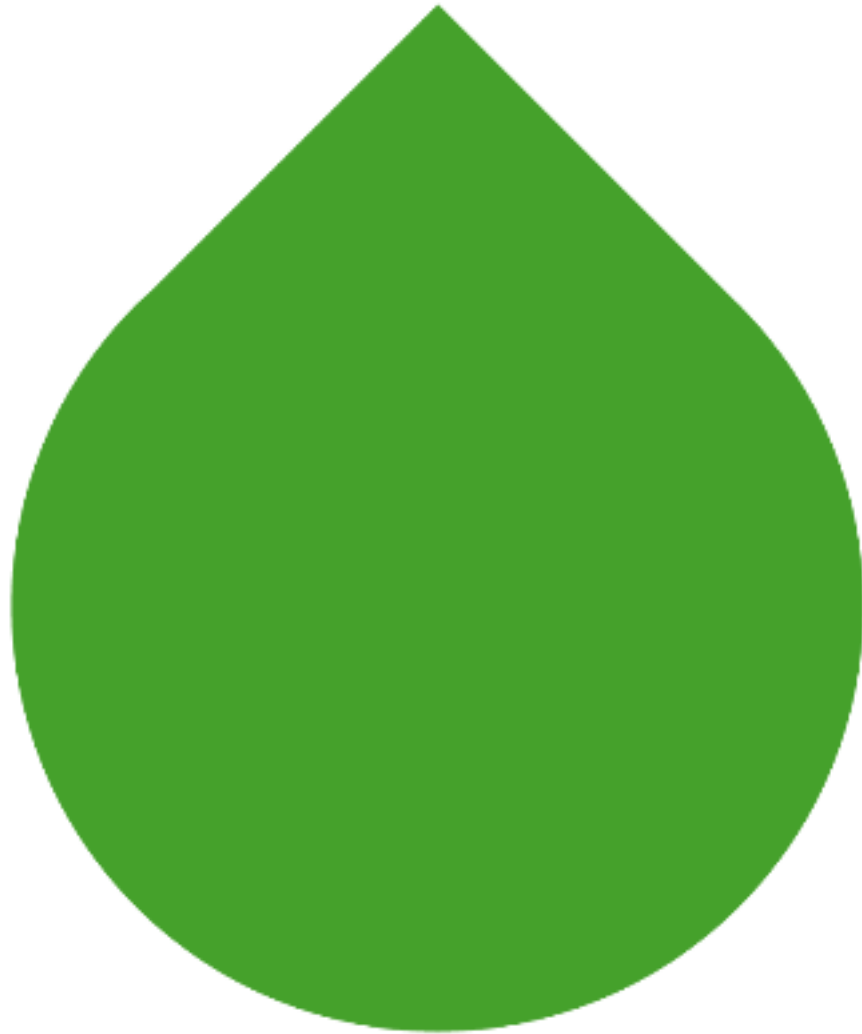

Posts from the RepRap Development Blog

Introduction

This document collects the blog posts from blog.reprap.org so as to provide easy off-line access and also to preserve an archival copy of the work.

The contents of blog.reprap.org are published under the GPL.

The original text and images have been extracted and converted by means of a script. This may have resulted in formatting errors or incorrectly transferred text. Please note that dead links may result in missing images. Comments have not been extracted, these can be found on the original blog site, a link to each blog post is given at the top of each post in this document. Please report any errata to contact@garyhodgson.com

Gary Hodgson, 2012

Contents

March 2005

23rd	RepRap,	<i>Adrian Bowyer</i>	P.1
24th	[No Title],	<i>Adrian Bowyer</i>	P.6
26th	[No Title],	<i>Adrian Bowyer</i>	P.7

April 2005

1st	[No Title],	<i>Adrian Bowyer</i>	P.8
4th	[No Title],	<i>Adrian Bowyer</i>	P.9
6th	[No Title],	<i>Adrian Bowyer</i>	P.10
8th	[No Title],	<i>Adrian Bowyer</i>	P.11
13th	[No Title],	<i>Adrian Bowyer</i>	P.12
14th	[No Title],	<i>Adrian Bowyer</i>	P.14
15th	[No Title],	<i>Adrian Bowyer</i>	P.16
18th	[No Title],	<i>Adrian Bowyer</i>	P.18
25th	[No Title],	<i>Adrian Bowyer</i>	P.20
29th	[No Title],	<i>Adrian Bowyer</i>	P.21
30th	Silver Paint Track Trials,	<i>Vik Olliver</i>	P.24

May 2005

1st	First Successful Silver Paint Circuit,	<i>Vik Olliver</i>	P.25
1st	Indicator for manual intervention.,	<i>Vik Olliver</i>	P.26
3rd	Test As You Go,	<i>Vik Olliver</i>	P.27
8th	PIC Software Development Kits,	<i>Vik Olliver</i>	P.28
8th	Sucrose structures,	<i>Vik Olliver</i>	P.29
9th	[No Title],	<i>Adrian Bowyer</i>	P.30
9th	[No Title],	<i>Adrian Bowyer</i>	P.31
9th	[No Title],	<i>Adrian Bowyer</i>	P.32
11th	[No Title],	<i>Adrian Bowyer</i>	P.33
13th	CAD System,	<i>Adrian Bowyer</i>	P.34
14th	The Icing on the Cake,	<i>Adrian Bowyer</i>	P.35
14th	First Physical Output From Aol,	<i>Vik Olliver</i>	P.39
15th	Square eyes,	<i>eD</i>	P.40
15th	[No Title],	<i>eD</i>	P.41
18th	PIC Software Development Kits,	<i>Vik Olliver</i>	P.42
20th	3-Axis Meccano Prototype,	<i>Vik Olliver</i>	P.43
21st	Axis Debut,	<i>eD</i>	P.44
21st	[No Title],	<i>eD</i>	P.45
21st	[No Title],	<i>eD</i>	P.46
21st	[No Title],	<i>eD</i>	P.47
26th	Polymorph and similar materials,	<i>Vik Olliver</i>	P.48
26th	[No Title],	<i>Vik Olliver</i>	P.49
28th	Extruding polymorph,	<i>Adrian Bowyer</i>	P.50

29th	Postscript to polymorph extrusion, <i>Adrian Bowyer</i>	P.54
29th	Polymorph moulding, <i>Vik Olliver</i>	P.56
29th	Turntable Scanner, <i>Vik Olliver</i>	P.57
31st	Finned extruder, <i>Vik Olliver</i>	P.58

June 2005

4th	Yet another polymorph extruder, <i>Adrian Bowyer</i>	P.59
6th	Extruder feed mechanism image, <i>Vik Olliver</i>	P.65
8th	Nozzle made of solder, <i>Vik Olliver</i>	P.66
10th	Metallic glass, <i>Adrian Bowyer</i>	P.67
11th	Carriages from Polymorph, <i>Vik Olliver</i>	P.68
12th	Feeder head for polymorph extrusion, <i>Adrian Bowyer</i>	P.71
13th	Idea for future circuit production, <i>Vik Olliver</i>	P.75
14th	Bolt-based Polymorph Pusher MkII Proposal, <i>Vik Olliver</i>	P.76
15th	Polymorph Carriage Tests, <i>Vik Olliver</i>	P.77
18th	Polymorph Carriage and Clips, <i>Vik Olliver</i>	P.78
22nd	Turntable Proposal Mk I, <i>Vik Olliver</i>	P.79
22nd	Possible new polymer, <i>Adrian Bowyer</i>	P.80
23rd	I2C And RS232 Code for PICs Under SDCC, <i>Vik Olliver</i>	P.81
23rd	Video Of Polymorph Saddles, <i>Vik Olliver</i>	P.82
25th	Strength of objects made by layered manufacturing, <i>Adrian Bowyer</i>	P.83
28th	Head mounts & sizes, <i>Vik Olliver</i>	P.84
30th	Ideas From The Dumpster, <i>Vik Olliver</i>	P.85

July 2005

2nd	Gantry Welded Over Meccano Prototype, <i>Vik Olliver</i>	P.86
10th	Going All Curly, <i>Vik Olliver</i>	P.87
10th	The "Afghan Lathe" technique - Updated, <i>Vik Olliver</i>	P.88
11th	Afghan Lathe as a web page, <i>Vik Olliver</i>	P.89
13th	Inverted wire-wrapping, <i>Vik Olliver</i>	P.90
15th	Closeup of Turntable, <i>Vik Olliver</i>	P.92
15th	Meccano prototype with new turntable, <i>Vik Olliver</i>	P.93
15th	Polylactic Acid, <i>Vik Olliver</i>	P.94
21st	Flat structures from EVA, <i>Vik Olliver</i>	P.95
22nd	Quick fixupses 'r' us, <i>Vik Olliver</i>	P.96
25th	It is an ex-glue gun. It has ceased to be., <i>Vik Olliver</i>	P.97
30th	PLA thermal characteristics, <i>Simon McAuliffe</i>	P.98

August 2005

1st	Steppin' in, steppin' out..., <i>Vik Olliver</i>	P.99
2nd	Floppy stepper update - updated :), <i>Vik Olliver</i>	P.100
8th	Screw thread drive preliminary experiment, <i>Vik Olliver</i>	P.101
12th	Powder-based RP technology, <i>Adrian Bowyer</i>	P.103
14th	The Two-Step, <i>Vik Olliver</i>	P.104
18th	Z Axis Stepper Report, <i>Vik Olliver</i>	P.106
19th	3-Axis motorisation complete, <i>Vik Olliver</i>	P.107

24th	Ready-made heaters,	<i>Vik Olliver</i>	P.109
29th	Meccano EVA extruder plans,	<i>Vik Olliver</i>	P.110

September 2005

10th	Head Design Released,	<i>Adrian Bowyer</i>	P.111
10th	Meccano prototype's first restarted object,	<i>Vik Olliver</i>	P.113
19th	Computer languages,	<i>Adrian Bowyer</i>	P.115
20th	First non-circular object printed,	<i>Vik Olliver</i>	P.116

October 2005

11th	Why so quiet?,	<i>Vik Olliver</i>	P.118
18th	Removing floppy steppers,	<i>Vik Olliver</i>	P.119
20th	First Polymorph Object Made,	<i>Adrian Bowyer</i>	P.120

November 2005

4th	Guy Fawkes Update,	<i>Vik Olliver</i>	P.121
6th	New Extruder,	<i>Adrian Bowyer</i>	P.123
6th	RepRap Wiki,	<i>Adrian Bowyer</i>	P.125
13th	Wire wrapping test,	<i>Vik Olliver</i>	P.126
22nd	Turntable raising gears fabricated,	<i>Vik Olliver</i>	P.128
26th	Insy Winsy Spider...,	<i>Vik Olliver</i>	P.129
27th	MK II Extruder, take 2,	<i>Vik Olliver</i>	P.130
28th	Join the resistance,	<i>Vik Olliver</i>	P.131

December 2005

1st	Our Carriage Awaits.,	<i>Vik Olliver</i>	P.132
6th	Polymorph and polycaprolactone,	<i>Adrian Bowyer</i>	P.133
13th	Clamps & spider arrive,	<i>Vik Olliver</i>	P.134
14th	Cartridge heater arrives!,	<i>Forrest Higgs</i>	P.135
14th	Building the filament extruder version 1.0,	<i>Forrest Higgs</i>	P.136
15th	Strange Economics...,	<i>Forrest Higgs</i>	P.137
15th	Screw-driven axis under construction,	<i>Vik Olliver</i>	P.138
16th	Screw-driven axis self-callibrates,	<i>Vik Olliver</i>	P.139
16th	Jigging the Filament Extruder Frame...,	<i>Forrest Higgs</i>	P.140
17th	Ready for the drill press...,	<i>Forrest Higgs</i>	P.142
18th	Central core of vertical axis ready,	<i>Vik Olliver</i>	P.143
19th	Progress on the filament extruder...,	<i>Forrest Higgs</i>	P.145
19th	Meccano on steroids...,	<i>Forrest Higgs</i>	P.146
20th	Heat Testing the Extruder Assembly...,	<i>Forrest Higgs</i>	P.147
23rd	Polymer needed,	<i>Adrian Bowyer</i>	P.148
23rd	Vertical platform successful test - 500g+,	<i>Vik Olliver</i>	P.149
28th	3D Cartesian axis, take 1,	<i>Vik Olliver</i>	P.150
29th	Welding Rig Arrives!,	<i>Forrest Higgs</i>	P.151

January 2006

2nd	Additional primitives for Aol?,	<i>Forrest Higgs</i>	P.152
-----	---------------------------------	----------------------	-------

2nd	Simple 3D Scanner, <i>Adrian Bowyer</i>	P.154
4th	What eD's doing, <i>eD</i>	P.155
5th	Threaded Rod Object done..., <i>Forrest Higgs</i>	P.157
6th	Pulley accuracy test rig, <i>eD</i>	P.158
7th	Duplicate Extruder Mechanism Mk2 Operational, <i>Vik Olliver</i>	P.159
7th	And finally the auger..., <i>Forrest Higgs</i>	P.160
10th	Weekend Design Charrette, <i>Forrest Higgs</i>	P.161
11th	Second Round, <i>Forrest Higgs</i>	P.162
12th	PCB production, <i>Adrian Bowyer</i>	P.163
13th	Third Round, <i>Forrest Higgs</i>	P.164
16th	Fourth Round Dieting..., <i>Forrest Higgs</i>	P.165
18th	Make your own plastic for RepRap, <i>Adrian Bowyer</i>	P.166
18th	Closing in on Godzilla..., <i>Forrest Higgs</i>	P.167
20th	Axis controller & extruder prototype boards, <i>Vik Olliver</i>	P.168
23rd	Concrete ideas, <i>Vik Olliver</i>	P.169
23rd	High Temperature Materials, <i>Adrian Bowyer</i>	P.170
23rd	Update on the Gingery filament extruder..., <i>Forrest Higgs</i>	P.171
24th	Steppers for Africa!, <i>Forrest Higgs</i>	P.173
25th	Capturing OpenGL data for prototyping, <i>Forrest Higgs</i>	P.174
27th	Steppers vs. Servos, <i>Adrian Bowyer</i>	P.175
30th	Torque Calculations for Vertical Power Screws, <i>Forrest Higgs</i>	P.176
30th	RepRap at LCA2006, <i>Vik Olliver</i>	P.178

February 2006

1st	X-axis done..., <i>Forrest Higgs</i>	P.181
2nd	Replacing PTFE with concrete, <i>Vik Olliver</i>	P.184
4th	Moving right along..., <i>Forrest Higgs</i>	P.185
5th	Progress with cement, <i>Vik Olliver</i>	P.189
6th	Second z-y stage built, <i>Forrest Higgs</i>	P.190
7th	First concrete test cylinder, <i>Vik Olliver</i>	P.192
7th	Godzilla is done for now..., <i>Forrest Higgs</i>	P.193
8th	Mk 2 parts arrive, <i>Forrest Higgs</i>	P.195
9th	String Wars, <i>eD</i>	P.196
10th	Building the JDM PIC Programmer Card..., <i>Forrest Higgs</i>	P.199
10th	Concrete insulator Mk 1, <i>Vik Olliver</i>	P.203
10th	RepRap, <i>Brett</i>	P.204
11th	PTFE-free extruder well plastered - and extruding, <i>Vik Olliver</i>	P.208
11th	JDM Programmer Card done..., <i>Forrest Higgs</i>	P.209
16th	Video of concrete extruder in operation, <i>Vik Olliver</i>	P.212
16th	PC Death @ Vik, <i>Vik Olliver</i>	P.213
17th	The next morning of filament extruder experimentation..., <i>Forrest Higgs</i>	P.214
17th	Reprap Musings, <i>Zach Smith</i>	P.215
17th	Initial experiments on filament extruder 2.0, <i>Forrest Higgs</i>	P.216
18th	The Concrete Extruder and Full RepRap Axis Assembly, <i>Vik Olliver</i>	P.219
19th	Integrating electronics..., <i>Forrest Higgs</i>	P.221
19th	Saturday afternoon filament extruder experiments, <i>Forrest Higgs</i>	P.225
20th	Vik's Presentation As A Stream, <i>Vik Olliver</i>	P.227

21st	The twist drill extruder, <i>Adrian Bowyer</i>	P.228
21st	Pumping CAPA 6800 meal..., <i>Forrest Higgs</i>	P.230
21st	Grinding CAPA 6800, <i>Forrest Higgs</i>	P.231
22nd	Nuff Faff, <i>eD</i>	P.233
23rd	Grinding Frozen Polymorph, <i>Adrian Bowyer</i>	P.234
25th	The twist drill extruder - initial experiments, <i>Adrian Bowyer</i>	P.235
26th	2559 Stepper board prototyped, <i>Vik Olliver</i>	P.237
27th	I<>3RP, <i>eD</i>	P.238
28th	Charitable thoughts..., <i>Adrian Bowyer</i>	P.240

March 2006

2nd	Design study for the 6.35 mm filament extruder, <i>Forrest Higgs</i>	P.241
3rd	New RepRap Member, <i>james low</i>	P.248
3rd	UDN2559-based control board going, <i>Vik Olliver</i>	P.250
5th	Electronics from Kicad and laserprinted PCBs, <i>Adrian Bowyer</i>	P.251
6th	Monday tests on the 6.35 mm filament extruder, <i>Forrest Higgs</i>	P.255
6th	Building the 6.35 mm filament extruder, <i>Forrest Higgs</i>	P.256
7th	Tests on the 6.35 mm filament extruder, <i>Forrest Higgs</i>	P.259
8th	Wednesday morning tests..., <i>Forrest Higgs</i>	P.263
8th	We appear to have another successful filament extruder concept..., <i>Forrest Higgs</i>	P.266
9th	Closing on producing usable filament..., <i>Forrest Higgs</i>	P.269
13th	UDN2559 Stripboard design, take 2, <i>Vik Olliver</i>	P.272
14th	Polygon software, <i>Adrian Bowyer</i>	P.273
14th	First Microchip PIC16F628 for Godzilla project programmed..., <i>Forrest Higgs</i>	P.277
14th	Making Version 2, <i>Forrest Higgs</i>	P.278
14th	Results of a complete breakdown of the quarter-inch extruder..., <i>Forrest Higgs</i>	P.280
14th	More post extrusion filament treatment..., <i>Forrest Higgs</i>	P.282
17th	Stewart platform, Rev 1., <i>Brett</i>	P.283
18th	Continued filament extrusion experiments., <i>Forrest Higgs</i>	P.286
19th	New cable wiring and connectors, <i>Simon McAuliffe</i>	P.288
21st	Getting the filament out of the bath..., <i>Forrest Higgs</i>	P.289
21st	Joints that don't break..., <i>Forrest Higgs</i>	P.291
21st	Quenching baths for CAPA, <i>Forrest Higgs</i>	P.292
22nd	Making the quenching bath be the takeup reel..., <i>Forrest Higgs</i>	P.293
23rd	Retiring the electric screwdriver..., <i>Forrest Higgs</i>	P.294
23rd	A workable coupling for the filament extruder, <i>Forrest Higgs</i>	P.297
24th	Networked Extruder Board in Alpha Release, <i>Vik Olliver</i>	P.299
24th	ARNIE finds her feet, <i>eD</i>	P.300
25th	Godzilla comms board just about done..., <i>Forrest Higgs</i>	P.301
26th	First filament extrusion run with added filler..., <i>Forrest Higgs</i>	P.302
27th	New stripboard layout for bipolar controller tested, <i>Simon McAuliffe</i>	P.303
28th	Ridiculous... :-/, <i>Forrest Higgs</i>	P.304
28th	Serendepity strikes again..., <i>Forrest Higgs</i>	P.305
29th	Potential support material..., <i>Forrest Higgs</i>	P.307
30th	First polypropylene extruded..., <i>Forrest Higgs</i>	P.309

April 2006

2nd	Slave board built, <i>Simon McAuliffe</i>	P.311
3rd	Godzilla comms board is operational..., <i>Forrest Higgs</i>	P.312
4th	First try at a stepper controller for Godzilla..., <i>Forrest Higgs</i>	P.313
4th	STL files and polygons, <i>Adrian Bowyer</i>	P.315
8th	Still Life With Stepper Controller Board and Stepper Motor...., <i>Forrest Higgs</i>	P.317
8th	Customisable addresses etc, <i>Simon McAuliffe</i>	P.319
9th	ARNIE Mk1 first build, <i>eD</i>	P.320
9th	Stripboard extruder controller, <i>Simon McAuliffe</i>	P.321
10th	Stage now moving under Java control, <i>Vik Olliver</i>	P.322
14th	The Godzilla stepper controller board takes shape..., <i>Forrest Higgs</i>	P.323
16th	RepRap Control Software, <i>Adrian Bowyer</i>	P.324
16th	3D Progress Previewer, <i>Simon McAuliffe</i>	P.325
18th	RepRap application, <i>Simon McAuliffe</i>	P.327
23rd	It drew a square for real!, <i>Vik Olliver</i>	P.328
24th	Extruder updates, <i>Simon McAuliffe</i>	P.329
26th	Godzilla y-axis tower moves..., <i>Forrest Higgs</i>	P.330
26th	Godzilla z-axis turns properly..., <i>Forrest Higgs</i>	P.331
27th	Full translation on the z-axis..., <i>Forrest Higgs</i>	P.333
30th	More work with the z-axis, <i>Forrest Higgs</i>	P.334

May 2006

12th	And here by popular request, boys and girls..., <i>Forrest Higgs</i>	P.335
13th	Time for a laugh, and a smile, <i>Vik Olliver</i>	P.337
14th	Something that looks like square and hexagon!, <i>Vik Olliver</i>	P.338
14th	Busy weeked with little to show, <i>Simon McAuliffe</i>	P.339
14th	The solution to yesterday's puzzle, <i>Vik Olliver</i>	P.342
15th	Limits on the gear script not as bad as thought..., <i>Forrest Higgs</i>	P.343
15th	Thoughts on scaleable RepRaps..., <i>Forrest Higgs</i>	P.345
15th	Meshing gears... Simon's question..., <i>Forrest Higgs</i>	P.347
15th	Heh, heh, heh... :-D, <i>Forrest Higgs</i>	P.349
15th	We have an involute gear script!, <i>Forrest Higgs</i>	P.351
16th	Gear reduction..., <i>Forrest Higgs</i>	P.352
16th	And some gears not so good, <i>Vik Olliver</i>	P.354
16th	A gearbox for Godzilla..., <i>Forrest Higgs</i>	P.355
16th	Refill of the syringe, <i>james low</i>	P.362
16th	Support material extruder, <i>james low</i>	P.365
16th	Support material conclusions, <i>james low</i>	P.368
16th	Godzilla vs the Siemens gearmotor..., <i>Forrest Higgs</i>	P.371
17th	Magnetic Shaft Encoders, <i>Adrian Bowyer</i>	P.372
17th	Steve Degroof asks a really good question..., <i>Forrest Higgs</i>	P.374
18th	Flagulation, <i>eD</i>	P.375
18th	Helical gears back on again, <i>Vik Olliver</i>	P.376
19th	LOL! Oh dear, here goes... plaas programs the PIC16F628, <i>Forrest Higgs</i>	P.377
21st	Simon & Vik's Bumper Fun Weekend Issue, <i>Vik Olliver</i>	P.378
22nd	Good news on the Java front, <i>Vik Olliver</i>	P.379

23rd	The frankenscrewdriver, <i>Vik Olliver</i>	P.380
25th	Echoing..., <i>Forrest Higgs</i>	P.381
26th	Digital servo, <i>Adrian Bowyer</i>	P.383
27th	Integrating the Frankenmotors into Godzilla..., <i>Forrest Higgs</i>	P.385
27th	Frankenmotors arrive..., <i>Forrest Higgs</i>	P.387
28th	0.5mm Mk 2 extruder trials/tribulations, <i>Vik Olliver</i>	P.389
28th	Speculations on RepRap 2.0, <i>Forrest Higgs</i>	P.390
29th	Frankenmotor meets Godzilla..., <i>Forrest Higgs</i>	P.392
31st	The Plan..., <i>Forrest Higgs</i>	P.394
31st	Plaas catches the cable and pulley disease..., <i>Forrest Higgs</i>	P.396

June 2006

4th	Quick work with the 0.8mm nozzle, <i>Vik Olliver</i>	P.397
4th	Making the 0.5mm nozzle work, <i>Vik Olliver</i>	P.398
5th	Basically PIC..., <i>Forrest Higgs</i>	P.400
7th	G4 Motor Control Card, <i>Forrest Higgs</i>	P.403
8th	PWMing along..., <i>Forrest Higgs</i>	P.405
10th	And the second string does exhibition during timeout..., <i>Forrest Higgs</i>	P.407
10th	Video of Da Witch in action, <i>Vik Olliver</i>	P.410
11th	Frankenmotors running all three axes on Godzilla..., <i>Forrest Higgs</i>	P.412
11th	Slicing and Dicing, <i>Adrian Bowyer</i>	P.413
11th	Godzilla y-axis meets the Frankenmotor..., <i>Forrest Higgs</i>	P.414
11th	Godzilla y-axis towers strung up!, <i>Forrest Higgs</i>	P.415
13th	First Complete Object & Tower of Ooze, <i>Vik Olliver</i>	P.419
14th	Thinking about making filament again..., <i>Forrest Higgs</i>	P.420
14th	Fine tuning Godzilla..., <i>Forrest Higgs</i>	P.423
15th	First crude attempts at calibration..., <i>Forrest Higgs</i>	P.424
16th	Vik doing Reprap when he should be resting his back..., <i>Vik Olliver</i>	P.426
17th	Heresy?, <i>Forrest Higgs</i>	P.427
17th	Testing assumptions about polymer melts..., <i>Forrest Higgs</i>	P.429
19th	Peristaltic Polyfilla, <i>Adrian Bowyer</i>	P.430
21st	More work on the Mk IIa..., <i>Forrest Higgs</i>	P.432
21st	First try at filament..., <i>Forrest Higgs</i>	P.433
21st	Shopping..., <i>Forrest Higgs</i>	P.439
23rd	MELabs USB PIC programmer board arrived..., <i>Forrest Higgs</i>	P.441
25th	Got direction and speed going for the little yellow G4 motor..., <i>Forrest Higgs</i>	P.442
27th	0.5mm Layers and Cooling, <i>Vik Olliver</i>	P.443
27th	Setting up for shaft encoding tests, <i>Forrest Higgs</i>	P.444
29th	ARNIE gets studding, and goes up..., <i>eD</i>	P.446

July 2006

2nd	Fan-boys and hairspray, <i>Vik Olliver</i>	P.447
3rd	We got shaft encoder pulses on the PIC!, <i>Forrest Higgs</i>	P.448
4th	ARNIE z-run performance, <i>eD</i>	P.449
5th	Done with shaft encoding..., <i>Forrest Higgs</i>	P.450
5th	True Grit, <i>Vik Olliver</i>	P.451

8th	Peristaltic pump go after all!, <i>Adrian Bowyer</i>	P.452
8th	Peristaltic pump no go, <i>Adrian Bowyer</i>	P.454
9th	Printing a real part, <i>Vik Olliver</i>	P.455
9th	Well THAT was easy!, <i>Forrest Higgs</i>	P.456
10th	Chips arrive!, <i>Forrest Higgs</i>	P.457
10th	Interrupt-driven serial comms no real challenge, <i>Forrest Higgs</i>	P.458
16th	Making interchangeable nozzles., <i>Vik Olliver</i>	P.459
17th	The RepRap mints a polo, <i>Vik Olliver</i>	P.460
18th	Controlling speed, direction and position of a brushed DC motor..., <i>Forrest Higgs</i>	P.461
19th	Feedback control of brushed DC motor speed, <i>Forrest Higgs</i>	P.462
20th	The Great Pyramid of Pholymer, <i>Vik Olliver</i>	P.463
20th	A new wrinkle on CAPA filament production..., <i>Forrest Higgs</i>	P.464
22nd	Frankenboard meets the Frankenmotor..., <i>Forrest Higgs</i>	P.469
24th	What we might make with a rerap..., <i>Forrest Higgs</i>	P.470
25th	RepRappers of the World Unite!, <i>Adrian Bowyer</i>	P.471
25th	Mk2a RepRap Polymer Extruder Head, <i>Vik Olliver</i>	P.472
26th	Frankenboard and Frankenmotor with IR Thermometer..., <i>Forrest Higgs</i>	P.473
29th	Sign For a RepRap, <i>Vik Olliver</i>	P.475
30th	Repstraperous, <i>Simon McAuliffe</i>	P.477
30th	Comms working again..., <i>Forrest Higgs</i>	P.478
31st	First tries at slicing and dicing..., <i>Forrest Higgs</i>	P.479

August 2006

3rd	More slicing and dicing..., <i>Forrest Higgs</i>	P.482
5th	Time to try another approach..., <i>Forrest Higgs</i>	P.484
5th	Quick and dirty support structures..., <i>Forrest Higgs</i>	P.485
5th	A good start at slicing and dicing..., <i>Forrest Higgs</i>	P.489
6th	First try at grids..., <i>Forrest Higgs</i>	P.491
8th	Grids rock!, <i>Forrest Higgs</i>	P.493
9th	Serious tests..., <i>Forrest Higgs</i>	P.496
11th	Infilling..., <i>Forrest Higgs</i>	P.497
12th	Diagonal Infilling..., <i>Forrest Higgs</i>	P.499
12th	Next gen RepRap in progress, <i>Vik Olliver</i>	P.501
13th	Hatching a thicker plot, <i>Adrian Bowyer</i>	P.502
13th	Rack and Pinion..., <i>Forrest Higgs</i>	P.503
13th	Second prototype gets some guts, <i>Vik Olliver</i>	P.504
14th	Under pressure, <i>Adrian Bowyer</i>	P.506
14th	Rethinking everything..., <i>Forrest Higgs</i>	P.509
15th	Rack those pinions..., <i>Forrest Higgs</i>	P.513
16th	A hole in my theory, <i>Simon McAuliffe</i>	P.516
17th	First part printed by Zaphod, <i>Vik Olliver</i>	P.517
28th	RepRap To Go, <i>Vik Olliver</i>	P.519

September 2006

1st	Biting the KiCad bullet..., <i>Forrest Higgs</i>	P.520
2nd	Common components for KiCad, <i>Forrest Higgs</i>	P.522

3rd	The mystery deepens, <i>Forrest Higgs</i>	P.523
4th	Use of Castable Bearings in RepRap, <i>Nick</i>	P.525
10th	RepRap on display in Vienna, <i>Vik Olliver</i>	P.529
13th	RepRap Makes a Name for Itself, <i>Vik Olliver</i>	P.530
14th	Quick update from Vienna, <i>Vik Olliver</i>	P.531
23rd	First Working Part Printed & Fitted, <i>Vik Olliver</i>	P.532
29th	RepRap Interview on Austrian TV, <i>Vik Olliver</i>	P.533

October 2006

8th	Involute profile gear tooth script pathology., <i>Forrest Higgs</i>	P.534
8th	More work on the involute profile gear script for Aol, <i>Forrest Higgs</i>	P.536
10th	Upgraded Aol Involute Profile Gear script..., <i>Forrest Higgs</i>	P.537
10th	Upgrading the Aol Involute Profile Gear Script..., <i>Forrest Higgs</i>	P.540
15th	Bug fix on the Experimental Involute Profile Gear script..., <i>Forrest Higgs</i>	P.541
16th	CAPA filament arrives..., <i>Forrest Higgs</i>	P.542
17th	Rethinking the Mk II heater nozzle..., <i>Forrest Higgs</i>	P.543
23rd	objects.reprap.org, <i>Sebastien Bailard</i>	P.552
23rd	The 'Fab @ Home' project, <i>Sebastien Bailard</i>	P.553
23rd	Polyethylene glycol as a potential water-soluble support mechanism., <i>Sebastien Bailard</i>	P.554
27th	More on filament and threaded rods..., <i>Forrest Higgs</i>	P.555
30th	More thoughts on the Mk II..., <i>Forrest Higgs</i>	P.556

November 2006

2nd	Extruding -- or not, <i>Simon McAuliffe</i>	P.558
4th	Test driving the RepStrap, <i>Simon McAuliffe</i>	P.560
5th	As he giveth so shall he taketh away, <i>Simon McAuliffe</i>	P.561
17th	A Printable Penguin, <i>Vik Olliver</i>	P.562
21st	Unexpected twist for new filament, <i>Forrest Higgs</i>	P.563
28th	Modesty demands..., <i>Adrian Bowyer</i>	P.565
28th	Faster, Cheaper, Better, <i>Simon McAuliffe</i>	P.566
29th	Milling about., <i>Sebastien Bailard</i>	P.569
29th	Bit of Edam, <i>eD</i>	P.571
29th	Universal PCB, <i>Adrian Bowyer</i>	P.572
30th	Universal PCB test, <i>Adrian Bowyer</i>	P.574

December 2006

3rd	Universal PCB update, <i>Adrian Bowyer</i>	P.576
12th	Lost units, <i>eD</i>	P.577
16th	Hiccup, <i>Adrian Bowyer</i>	P.578

January 2007

2nd	Experimental gear train, <i>Vik Olliver</i>	P.579
5th	Java anyone?, <i>Forrest Higgs</i>	P.580
6th	Cheers!, <i>Vik Olliver</i>	P.583
6th	Filament supply line & belt drives, <i>Vik Olliver</i>	P.584
8th	Darwin's first cut, <i>eD</i>	P.586

11th	Support material, <i>Adrian Bowyer</i>	P.587
13th	More on PVA as a support, <i>Adrian Bowyer</i>	P.588
17th	RepRap at Linuxconf Australia 2007, <i>Vik Olliver</i>	P.590
23rd	RepRap 1.0 "Darwin" Communications and Power Distribution, <i>Adrian Bowyer</i>	P.591
29th	Mk 2 Extruder part made on Zaphod, <i>Vik Olliver</i>	P.592
30th	Now a motor-holder part, <i>Vik Olliver</i>	P.595

February 2007

2nd	A.R.N.I.E. gives it a shot..., <i>Adrian Bowyer</i>	P.597
8th	Moulding gears, <i>eD</i>	P.598
9th	RepRapped extruder parts, <i>Vik Olliver</i>	P.600
11th	CAPA Extruder Pushes Filament, <i>Vik Olliver</i>	P.601
17th	Extruding HDPE in the Mk 2.1, <i>Forrest Higgs</i>	P.602
17th	Pressing Belt Gears, <i>Vik Olliver</i>	P.603
22nd	Website Architecture Changes, <i>Zach Smith</i>	P.605
25th	Low-melting-point alloys, <i>Adrian Bowyer</i>	P.606
26th	Paste extruder, <i>Adrian Bowyer</i>	P.609
26th	Printing with conventional solder, <i>Forrest Higgs</i>	P.611
26th	Printing circuitry in the low-rent district, <i>Forrest Higgs</i>	P.612

March 2007

3rd	Shameless publicity and cash seeking, <i>Adrian Bowyer</i>	P.616
4th	PowerComms Board v1.1, <i>Zach Smith</i>	P.617
4th	CAPA vs. ABS bodies extruders, <i>Vik Olliver</i>	P.618
5th	Darwin makes a move, <i>eD</i>	P.619
6th	Sebastien's polyethylene glycol, <i>Adrian Bowyer</i>	P.621
6th	The Extruded Extruder Extrudes!, <i>Vik Olliver</i>	P.622
9th	BBQ paint fails, <i>Forrest Higgs</i>	P.623
12th	Moulding thin walled gears, succeeds (!), <i>eD</i>	P.624
16th	Darwin's X-axis toothed pulley, <i>eD</i>	P.627
16th	Darwin's Y-axis repeatability, <i>eD</i>	P.628
16th	PowerComms v1.1: Success!, <i>Zach Smith</i>	P.630
23rd	Bendy extruder gets things straight, <i>Adrian Bowyer</i>	P.631
25th	Time-lapse video of test hexagon., <i>Vik Olliver</i>	P.632
26th	Darwin's X axis repeatability, <i>eD</i>	P.633
27th	Untimely Lapse Movie, <i>Vik Olliver</i>	P.634
31st	ETech 2007, <i>Forrest Higgs</i>	P.635

April 2007

9th	Darwin assembly instructions, <i>eD</i>	P.637
10th	Another time lapse - the logo (almost), <i>Vik Olliver</i>	P.638
11th	Congratulations to ArtOfIllusion, <i>Vik Olliver</i>	P.639
11th	What happens when a US National Laboratory tries to make a RepRap, <i>Forrest Higgs</i>	P.640
11th	You Look Like My (proto)Type, <i>Zach Smith</i>	P.641
14th	Tommelise joins Zaphod and A.R.N.I.E., <i>Forrest Higgs</i>	P.642
17th	You can't spread a bit of CAPA on your copper, <i>Vik Olliver</i>	P.643

18th	Printing HDPE on copper., <i>Forrest Higgs</i>	P.644
22nd	RepRap wasn't built in a day, <i>Adrian Bowyer</i>	P.645
27th	i <3 aluminum, <i>Zach Smith</i>	P.646
28th	Aluminum Barrel Success!, <i>Zach Smith</i>	P.649

May 2007

1st	Opto-endstop cutie pie'd, <i>eD</i>	P.650
6th	PowerComms & Universal v1.2, <i>Zach Smith</i>	P.651
10th	Catwalk, <i>Adrian Bowyer</i>	P.652
10th	Wired, <i>eD</i>	P.654
13th	PLA Filament works, <i>Vik Olliver</i>	P.655
14th	RepRap needs your JAVA help!, <i>Zach Smith</i>	P.657
15th	Slimline Darwin Designs, <i>Adrian Bowyer</i>	P.658
15th	Flask with overhangs in PLA, <i>Vik Olliver</i>	P.659
18th	More squiggles..., <i>Forrest Higgs</i>	P.660
18th	Support material miracle, <i>Vik Olliver</i>	P.661
19th	Another support material miracle?, <i>Forrest Higgs</i>	P.662
22nd	PLA Darwin part, <i>Vik Olliver</i>	P.664
23rd	Announcing the RepRap Research Foundation, <i>Zach Smith</i>	P.665
24th	PowerComms v1.2 Build, <i>Zach Smith</i>	P.666
25th	Darwin parts analysis, <i>eD</i>	P.667
28th	PLA Darwin Parts From Zaphod, <i>Vik Olliver</i>	P.669
31st	Opto Endstop Boards Arrived!, <i>Zach Smith</i>	P.670

June 2007

6th	Very fine RepRap nozzles, <i>Adrian Bowyer</i>	P.671
6th	RepRap Host v0.8 Released, <i>Zach Smith</i>	P.672
9th	V1.2 Universal Extruder Board Assembly, <i>Vik Olliver</i>	P.673
15th	RepRap V1.2 Stepper Controller Board instructions done., <i>Vik Olliver</i>	P.674
19th	Token ring gold, <i>Adrian Bowyer</i>	P.675
28th	Silicone enhanced RepRap, <i>Adrian Bowyer</i>	P.676
28th	Memory hog is bacon, <i>Adrian Bowyer</i>	P.678
29th	Filling in the cracks, <i>Adrian Bowyer</i>	P.679
29th	RepRap Going To O'Reilly OSCON 2007, <i>Vik Olliver</i>	P.680

July 2007

6th	Darwin's Adventures Down Under, <i>Vik Olliver</i>	P.681
16th	Mendel Preview, <i>Adrian Bowyer</i>	P.682
20th	RepRap Talk Online, <i>Zach Smith</i>	P.683
27th	Where is home?, <i>eD</i>	P.684

August 2007

7th	Quick change artist, <i>Adrian Bowyer</i>	P.686
14th	Aluminum Extruder Sneak Peek, <i>Zach Smith</i>	P.687
24th	RepRaps by the ton, <i>Adrian Bowyer</i>	P.688
25th	Honey! I replicated the cat!, <i>Vik Olliver</i>	P.691

28th	RepRap progress is faster than a speeding bullet,	<i>Adrian Bowyer</i>	P.692
30th	RepRaps by the ton II,	<i>Adrian Bowyer</i>	P.693

September 2007

8th	Volunteers needed!,	<i>Adrian Bowyer</i>	P.694
9th	Extruding from granules,	<i>Adrian Bowyer</i>	P.696
14th	More on the granule extruder,	<i>Adrian Bowyer</i>	P.697
17th	Darwin's bits,	<i>eD</i>	P.699
17th	Extruder temperature bug (almost) eliminated,	<i>Adrian Bowyer</i>	P.700
18th	PowerComms v1.3.0 Beta,	<i>Zach Smith</i>	P.702
19th	Trivial Update Post: Opto Enstop Docs,	<i>Zach Smith</i>	P.703
20th	We Strive To Improve...,	<i>Vik Olliver</i>	P.704
23rd	Waitakere Darwin 1.0 Printing in PLA,	<i>Vik Olliver</i>	P.705
24th	Moulding RepRaps,	<i>Adrian Bowyer</i>	P.706
26th	Object file release updates,	<i>eD</i>	P.710
26th	Smokin' The Gear,	<i>Vik Olliver</i>	P.711
27th	Running smoothly - for 5 minutes,	<i>Vik Olliver</i>	P.712
28th	The extruder lives - again,	<i>Vik Olliver</i>	P.713
30th	Cheers! Another Minimug Emerges.,	<i>Vik Olliver</i>	P.714

October 2007

3rd	RepRaps by the ton III,	<i>Adrian Bowyer</i>	P.715
4th	PICs Reading USB Drives,	<i>Vik Olliver</i>	P.716
6th	Tha intakes are clogged wi' dust, Capt'n,	<i>Vik Olliver</i>	P.717
10th	RepRap goes to MIT,	<i>Adrian Bowyer</i>	P.718
12th	For those who prefer mixers,	<i>Vik Olliver</i>	P.720
12th	First RepRap'd Z-Axis Pulley Rim,	<i>Vik Olliver</i>	P.721
17th	Having a little wine,	<i>Vik Olliver</i>	P.723
19th	X-Idler Bracket Printed,	<i>Vik Olliver</i>	P.724
20th	X-Idler Bracket Continued,	<i>Vik Olliver</i>	P.725
21st	X-axis idler assembly in PLA,	<i>Vik Olliver</i>	P.727
23rd	The latest from Adrian,	<i>Forrest Higgs</i>	P.728
23rd	[No Title],	<i>Adrian Bowyer</i>	P.729
25th	RepRap visits a FabLab,	<i>Adrian Bowyer</i>	P.730
29th	Time to sort the software,	<i>Vik Olliver</i>	P.732

November 2007

2nd	RepRap Part Lister,	<i>Zach Smith</i>	P.733
3rd	RepRap at Linuxconf Australia 2008,	<i>Vik Olliver</i>	P.734
6th	Extruder Casting Photos,	<i>Zach Smith</i>	P.735
7th	DC Motor Driver v1.0 Documented,	<i>Zach Smith</i>	P.737
10th	RepRap User Groups,	<i>Sebastien Bailard</i>	P.738
11th	Thoughts on printing at ambient temperatures,	<i>Forrest Higgs</i>	P.739
14th	New Firmware Release,	<i>Adrian Bowyer</i>	P.740
14th	Extruder output profile,	<i>eD</i>	P.741
15th	Postscript: RepRap goes home from the USA,	<i>Adrian Bowyer</i>	P.742

16th	Amazin' Saddles, <i>Vik Olliver</i>	P.743
21st	PowerComms v1.3 Released, <i>Zach Smith</i>	P.744
23rd	Thank You MAKEzine!, <i>Zach Smith</i>	P.745
27th	New z flag adjuster, <i>eD</i>	P.746
27th	Producer/LayerProducer code changes, <i>eD</i>	P.747
29th	Resin paste-extruder valve, <i>Adrian Bowyer</i>	P.748

December 2007

5th	Machinist Help Needed, <i>Zach Smith</i>	P.749
7th	RepRappers: Unite!, <i>Zach Smith</i>	P.750
7th	A day in the life of RepRap, <i>eD</i>	P.751
9th	A Wet Weekend in Taupo, <i>Vik Olliver</i>	P.752
10th	Half a step forward, <i>Adrian Bowyer</i>	P.753
11th	Wiping up, <i>eD</i>	P.754
13th	Commit to SVN for nozzle-wipe method, <i>eD</i>	P.755
15th	Print Head Auto-Encapsulation, <i>Vik Olliver</i>	P.756
18th	eMachined Extruder Parts, <i>Zach Smith</i>	P.757
19th	Experimental firmware working, <i>Adrian Bowyer</i>	P.758
21st	Encapsulated Extruder Hopeless - Built New One, <i>Vik Olliver</i>	P.759
31st	[No Title], <i>Vik Olliver</i>	P.761

January 2008

3rd	New manufacturing process, <i>Adrian Bowyer</i>	P.762
4th	RepRap at UK Science Museum, <i>Zach Smith</i>	P.763
6th	PWM Driver v1.1 / DC Motor Driver v1.1 Released, <i>Zach Smith</i>	P.764
6th	Paste Extruder water tests., <i>Vik Olliver</i>	P.765
7th	Reprap Host 0.8.3 Released, <i>Jonathan Marsden</i>	P.766
8th	First Corner Bracket, <i>Vik Olliver</i>	P.767
10th	Segment pause bug-fix committed, <i>eD</i>	P.768
11th	Advanced Electronics Thoughts, <i>Zach Smith</i>	P.769
11th	Corner Bracket photos and Bed Corner, <i>Vik Olliver</i>	P.771
12th	Bed Corner Printout Success, <i>Vik Olliver</i>	P.773
12th	Arduino Firmware v1.1 Released, <i>Zach Smith</i>	P.775
13th	Bed Corner and Diagonal Tie Bracket, <i>Vik Olliver</i>	P.776
16th	Darwin on CAPA, <i>eD</i>	P.777
18th	Extrusion at different temps, <i>eD</i>	P.778
18th	Geared extrusion, <i>eD</i>	P.779
20th	Optoswitch bracket printed, <i>eD</i>	P.780
20th	Z Axis Kebab Printed, <i>Vik Olliver</i>	P.781
21st	Extruder feedback, <i>eD</i>	P.783
21st	In stereo - another opto bracket, <i>Vik Olliver</i>	P.784
22nd	On the road to replication, <i>Vik Olliver</i>	P.785
23rd	Update from he who feels like hammered sh..., <i>Vik Olliver</i>	P.786
24th	Another pile of parts falls out of the RepRap, <i>Vik Olliver</i>	P.787

February 2008

7th	PTFE slippage, <i>Adrian Bowyer</i>	P.788
8th	Back from Melbourne, <i>Vik Olliver</i>	P.789
9th	X Motor Bracket, <i>Vik Olliver</i>	P.791
9th	Half-Way to Replication!, <i>Vik Olliver</i>	P.792
11th	98% Of A Carriage, <i>Vik Olliver</i>	P.793
15th	Software Outside The Box (Updated), <i>Vik Olliver</i>	P.795
17th	Objects.RepRap.Org - Any volunteers?, <i>Sebastien Bailard</i>	P.796
19th	Difficulties With Coupling, <i>Vik Olliver</i>	P.798
21st	Coupling Breakage Update & Images, <i>Vik Olliver</i>	P.799
21st	My Darwin's First Print, <i>Zach Smith</i>	P.801
22nd	Ponoko's Lasercut RepRap, <i>Vik Olliver</i>	P.802
22nd	Arduino Firmware v1.2 Released!, <i>Zach Smith</i>	P.803
26th	Software fixed. Many new special bugs introduced..., <i>Adrian Bowyer</i>	P.804
29th	UV plant-derived resins for RepRap, <i>Adrian Bowyer</i>	P.805
29th	FabLab and RepRap, <i>Zach Smith</i>	P.807
29th	Darwin@Adrian, <i>Adrian Bowyer</i>	P.808

March 2008

2nd	Ratcheted filament driver, <i>Vik Olliver</i>	P.809
3rd	Align parts database, <i>Adrian Bowyer</i>	P.810
7th	Preferences file for the host software, <i>Adrian Bowyer</i>	P.811
7th	Beaded Belt Drive Success, <i>Vik Olliver</i>	P.812
8th	Extruder temperatures, <i>nophead</i>	P.814
9th	Blow your nose and clean your teeth, <i>Adrian Bowyer</i>	P.815
11th	RepRap Segment Pausing Fix, <i>Zach Smith</i>	P.817
12th	ExtruderDelay parameter mod, <i>eD</i>	P.818
13th	Coupling gets too hot, <i>Vik Olliver</i>	P.819
14th	While coupling, I killed the X axis, <i>Vik Olliver</i>	P.822
15th	Doctor blade, <i>Adrian Bowyer</i>	P.823
16th	Coupling Issues Solved, <i>Vik Olliver</i>	P.824
17th	Nozzle Cleaning Part Deux, <i>Adrian Bowyer</i>	P.826
17th	A high temperature extruder?, <i>nophead</i>	P.827
20th	More Nose-Wiping Action And A Boo-Boo, <i>Vik Olliver</i>	P.828
23rd	Yet Another Minimug, <i>Adrian Bowyer</i>	P.829
24th	Replacing in-situ, <i>Adrian Bowyer</i>	P.831
29th	Arduino chosen for next stage of RepRap development, <i>Adrian Bowyer</i>	P.832
30th	Serendipity, <i>Adrian Bowyer</i>	P.833

April 2008

2nd	New Board: Thermocouple Sensor v1.0, <i>Zach Smith</i>	P.835
2nd	New Board: Arduino Breakout v1.1, <i>Zach Smith</i>	P.836
3rd	Z Motor Adaptor Plate, <i>Vik Olliver</i>	P.837
4th	RepRap extruder does ABS, <i>nophead</i>	P.838
4th	Ponoko.com lasercut kit, strike 2, <i>Vik Olliver</i>	P.839
6th	Granule extruder, <i>Adrian Bowyer</i>	P.841
8th	Hello Slashdoters, <i>Vik Olliver</i>	P.843

9th	A few thoughts on warping, <i>Forrest Higgs</i>	P.844
12th	RepRap in Oslo, <i>Adrian Bowyer</i>	P.846
12th	Some estimates..., <i>Forrest Higgs</i>	P.848
14th	An iPod in your Ford, <i>Adrian Bowyer</i>	P.849
15th	Anti-ooze, <i>eD</i>	P.851
15th	Simple Hot Metal Valve, <i>Adrian Bowyer</i>	P.853
18th	RepRap prints a child, <i>eD</i>	P.855
18th	Shaving The Yak, <i>Vik Olliver</i>	P.856
20th	New Board: Arduino Breakout Shield v1.2, <i>Zach Smith</i>	P.857
20th	New Board: Temperature Sensor v1.1, <i>Zach Smith</i>	P.858
20th	More anti-ooze, <i>Adrian Bowyer</i>	P.859
23rd	Darwin@Adrian goes Arduino, <i>Adrian Bowyer</i>	P.861
24th	Made in China, <i>Forrest Higgs</i>	P.863
24th	Magnetic Rotary Encoder Design, <i>Zach Smith</i>	P.865
25th	Ball-chain update, <i>Vik Olliver</i>	P.866
29th	Gripping Stuff - The Extruder Clamp, <i>Vik Olliver</i>	P.867

May 2008

1st	Anti-ooze - the first design, <i>Adrian Bowyer</i>	P.868
2nd	PLA & Stepper Drivers in NZ, <i>Vik Olliver</i>	P.869
3rd	Economics (n. pl.: the management of a household), <i>Adrian Bowyer</i>	P.870
3rd	PLA Corner bracket failure mode, <i>Vik Olliver</i>	P.872
6th	Open sesame..., <i>Adrian Bowyer</i>	P.873
7th	Bug fixing, <i>Adrian Bowyer</i>	P.875
11th	Freeduino is free., <i>Zach Smith</i>	P.877
15th	Inter-layer cooling?, <i>eD</i>	P.878
19th	Progress with ABS, <i>nophead</i>	P.879
20th	Shoe, <i>Adrian Bowyer</i>	P.881
22nd	ABS Door handle, <i>nophead</i>	P.883
22nd	Then there were two..., <i>Adrian Bowyer</i>	P.886
23rd	TRADITIONAL flyswatter :-), <i>Adrian Bowyer</i>	P.887
23rd	Laser-Sighted Flyswatter, <i>Vik Olliver</i>	P.888
27th	Quality development, <i>eD</i>	P.889
27th	Arduino Firmware v1.3 Released, <i>Zach Smith</i>	P.890
31st	Come and see RepRap!, <i>Adrian Bowyer</i>	P.891

June 2008

1st	ABS coat hook, <i>nophead</i>	P.892
3rd	RepRap achieves replication!, <i>Adrian Bowyer</i>	P.893
5th	Full Electronics Kit Now Available, <i>Zach Smith</i>	P.894
9th	RepRap at the Cheltenham Science Fest, <i>Adrian Bowyer</i>	P.895
10th	Sensing temperature with no temperature sensor, <i>Adrian Bowyer</i>	P.896
13th	Intermediate Java release, <i>Adrian Bowyer</i>	P.898
13th	PIC file release, <i>Adrian Bowyer</i>	P.899
14th	Unsupported!, <i>nophead</i>	P.900
18th	Line buffering in the Arduino, <i>Adrian Bowyer</i>	P.903

20th	New Board: Opto Isolator v1.0, <i>Zach Smith</i>	P.904
25th	Measuring extruder temperature using Adrian's circuit, <i>Forrest Higgs</i>	P.905
26th	RepRap At OSCON 2008, <i>Vik Olliver</i>	P.908

July 2008

2nd	Java Host Software, <i>Adrian Bowyer</i>	P.909
2nd	Hacking the Solarbotics GM3 Gearmotor, <i>Zach Smith</i>	P.910
9th	Extruder instructions, <i>Adrian Bowyer</i>	P.911
12th	Multilingual Host Software, <i>Adrian Bowyer</i>	P.912
12th	Revisiting the recycling of Reprap plastics, <i>Forrest Higgs</i>	P.913
13th	New Board: Magnetic Rotary Encoder v1.0, <i>Zach Smith</i>	P.917
21st	RepRap Child Now At OSCON in Portland, <i>Vik Olliver</i>	P.918
22nd	OSCON RepRap Butchered, <i>Vik Olliver</i>	P.919
22nd	Bits from Bytes RepRap now in Subversion, <i>Adrian Bowyer</i>	P.920
22nd	Minor notes on the Zach's Opto-endstop PCB, <i>Forrest Higgs</i>	P.922
23rd	A bit more about Zach's opto-endstop, <i>Forrest Higgs</i>	P.924
26th	Every little helps, <i>nophead</i>	P.926
28th	Foundations, <i>Adrian Bowyer</i>	P.929
29th	TSA Really Wreck The RepRap Child, <i>Vik Olliver</i>	P.931
31st	An affordable alternative to JB-Weld and BBQ paint?, <i>Forrest Higgs</i>	P.932

August 2008

2nd	My bad: another note about compact flash cards, <i>Forrest Higgs</i>	P.934
2nd	A note about compact flash cards, <i>Forrest Higgs</i>	P.935
6th	Extruder alternatives, <i>Adrian Bowyer</i>	P.937
8th	Announcing: Sanguino v1.0, <i>Zach Smith</i>	P.939
10th	Going for an EDM toolhead, <i>Forrest Higgs</i>	P.940
12th	RepRapped Shaft Encoder, <i>nophead</i>	P.943
15th	RepRap Parts Lister Update, <i>Zach Smith</i>	P.944
16th	Belt tensioner, <i>Vik Olliver</i>	P.945
17th	Blood on the carpet..., <i>Adrian Bowyer</i>	P.946
18th	Milling plastic with a Reprap machine?, <i>Forrest Higgs</i>	P.948
19th	Extruder valve, <i>Adrian Bowyer</i>	P.950
20th	Arc Compensation, <i>Adrian Bowyer</i>	P.952
21st	Going Round In Circles, <i>Vik Olliver</i>	P.953
21st	New X Carriage Hot Off The RepRap, <i>Vik Olliver</i>	P.954

September 2008

1st	RepRapped Screw Thread, <i>nophead</i>	P.955
3rd	Announcing ReplicatorG 0001, <i>Zach Smith</i>	P.956
5th	Ball-chain for X axis, <i>Vik Olliver</i>	P.957
11th	All these parameters? WTF!?, <i>Adrian Bowyer</i>	P.958
11th	Stripboard Sanguino, <i>Adrian Bowyer</i>	P.959
12th	Off to Italy, <i>Adrian Bowyer</i>	P.961
15th	Phoenix Gets A NEMA 17, <i>Vik Olliver</i>	P.962
18th	Sanguino Software v1.1, <i>Zach Smith</i>	P.963

26th	Sanguino Software v1.2 Released, <i>Zach Smith</i>	P.964
26th	New Board: Sanguino Breakout v1.0, <i>Zach Smith</i>	P.965
26th	New Board: GM3 Noise Suppressor v1.0, <i>Zach Smith</i>	P.966
27th	Sanguino RepRap, <i>Adrian Bowyer</i>	P.968
29th	Ponoko Lasercut Prototype Strike 3, <i>Vik Olliver</i>	P.970
29th	Meshlab, <i>Forrest Higgs</i>	P.972
30th	Meshlab Discovery - The Origins, <i>Vik Olliver</i>	P.976

October 2008

1st	RepRap Builder's Wiki, <i>Adrian Bowyer</i>	P.977
1st	Belts anyone?, <i>Forrest Higgs</i>	P.978
1st	Testing the envelope, <i>Forrest Higgs</i>	P.980
3rd	New Board: Stepper Motor Driver v1.2, <i>Zach Smith</i>	P.984
3rd	Wahooo!!, <i>Zach Smith</i>	P.986
4th	Building ABS on a lasercut/fabbed Darwin, <i>Vik Olliver</i>	P.988
5th	RepStrap In Chains, <i>Vik Olliver</i>	P.990
8th	New Board: Arduino Breakout Shield v1.4, <i>Zach Smith</i>	P.991
12th	RS485 Circuit = Success, <i>Zach Smith</i>	P.992
15th	Yes - it's a square..., <i>Adrian Bowyer</i>	P.995
17th	ReplicatorG 0002 Release, <i>Zach Smith</i>	P.997
17th	Sanguino Software v1.3 Release, <i>Zach Smith</i>	P.999
19th	Lasercut RepRap Available in Australasia & US, <i>Vik Olliver</i>	P.1000
25th	Multimode Host Software, <i>Adrian Bowyer</i>	P.1001
26th	New Board: LCD Controller v1.0, <i>Zach Smith</i>	P.1002
26th	New code first build, <i>Adrian Bowyer</i>	P.1004
29th	Exchangeable Lasercut Extruder, <i>Vik Olliver</i>	P.1006
30th	Puddle to the Metal, <i>Adrian Bowyer</i>	P.1007

November 2008

6th	Lasercut RepRap Extruder Instructions on Wiki, <i>Vik Olliver</i>	P.1008
7th	About !*\$!*&! time..., <i>Adrian Bowyer</i>	P.1009
11th	DIY PLA, <i>Adrian Bowyer</i>	P.1010
16th	Multiple materials, <i>Adrian Bowyer</i>	P.1012
17th	Announcing Thingiverse.com, <i>Zach Smith</i>	P.1013
24th	Idea for reduced cartesian structure, <i>eD</i>	P.1014
27th	Heating the print surface: doing the numbers, <i>Forrest Higgs</i>	P.1015
28th	Award for RepRap?, <i>Adrian Bowyer</i>	P.1020
30th	Suppression, <i>nophead</i>	P.1021
30th	Sphere, <i>Steve DeGroof</i>	P.1024
30th	Granule Extruder - the sequel, <i>Adrian Bowyer</i>	P.1026
30th	Another approach to heating the print surface, <i>Forrest Higgs</i>	P.1029

December 2008

4th	Solid Model files for Darwin's Cartesian Bot, <i>eD</i>	P.1032
5th	Building a printable stepper for a next generation Tommelise, <i>Forrest Higgs</i>	P.1033
11th	No-curl hair dryer, <i>Adrian Bowyer</i>	P.1039

11th	Chemically grinding ABS scrap: part 2, <i>Forrest Higgs</i>	P.1041
14th	Ponoko Lasercut RepRap BoM, <i>Vik Olliver</i>	P.1043
19th	Paste extruder motor test, <i>eD</i>	P.1045
19th	Well. That didn't work..., <i>Adrian Bowyer</i>	P.1047
21st	Sticking point, <i>nophead</i>	P.1049
21st	Non-captive Gearmotor, <i>Steve DeGroof</i>	P.1050
22nd	Roast-in-a-bag Duck..., <i>Adrian Bowyer</i>	P.1052
24th	Mother of all Boards..., <i>Adrian Bowyer</i>	P.1055

January 2009

9th	IRC Chat Now Has An Archived Log, <i>Vik Olliver</i>	P.1057
10th	[No Title], <i>Zach Smith</i>	P.1058
12th	Pinch Wheel Extruder Prototype, <i>Zach Smith</i>	P.1060
14th	MiB, <i>Adrian Bowyer</i>	P.1064
16th	Pinch Wheel Extruder Prototype v1.1, <i>Zach Smith</i>	P.1065
16th	After Darwin: Should Mendel be a specific 3D printer or a technology toolbox?, <i>Forrest Higgs</i>	P.1070
17th	Pinch Wheel Extruder Is Alive, <i>Zach Smith</i>	P.1078
17th	CSG Evaluator - An Aol plugin for convenient Boolean Operations, <i>Zach Smith</i>	P.1081
19th	4 Dimensional RepRap, <i>Adrian Bowyer</i>	P.1082
20th	HACDC RepRap Buildathon, <i>Zach Smith</i>	P.1084
20th	Going high risk steampunk, <i>Forrest Higgs</i>	P.1085
22nd	3D printing on Facebook, <i>Adrian Bowyer</i>	P.1088
27th	[No Title], <i>Marius Kintel</i>	P.1089
27th	Conserving MCU pins via the I2C bus, <i>Forrest Higgs</i>	P.1090
28th	Support for overhangs, <i>Adrian Bowyer</i>	P.1094
28th	SolidEdge Version Poll, <i>eD</i>	P.1098

February 2009

3rd	RepRap in Madrid, <i>Adrian Bowyer</i>	P.1099
10th	First thrust plate for a printable stepper motor milled, <i>Forrest Higgs</i>	P.1101
15th	RP Pinch-wheel Extruder, <i>Adrian Bowyer</i>	P.1103
17th	Sanguino Software v1.4 Release, <i>Zach Smith</i>	P.1107
17th	Back From Madrid, <i>Zach Smith</i>	P.1108
17th	RP Pinch-wheel Extruder II, <i>Adrian Bowyer</i>	P.1110
18th	IR Ranging, <i>Forrest Higgs</i>	P.1111
20th	OLPC Viewfinder, <i>Vik Olliver</i>	P.1114
20th	Stepper pinch-wheel extruder building, <i>Adrian Bowyer</i>	P.1116
21st	Tip: Easy Way to Thread Y Belt, <i>Zach Smith</i>	P.1117
22nd	Pull Yourself Together, Bot!, <i>Zach Smith</i>	P.1118
22nd	Racks and pinions, <i>Forrest Higgs</i>	P.1125

March 2009

1st	Wedge Design Proof Of Concept, <i>Vik Olliver</i>	P.1128
2nd	Thingiverse Tools System Released, <i>Zach Smith</i>	P.1130
2nd	For now we see through a glass, darkly..., <i>Forrest Higgs</i>	P.1131
4th	Wedge Design Bracing, <i>Vik Olliver</i>	P.1138

5th	Vitamins and minerals, <i>Forrest Higgs</i>	P.1139
7th	Powering the tin can stepper lead screw, <i>Forrest Higgs</i>	P.1144
9th	A small milestone, <i>Forrest Higgs</i>	P.1147
9th	Abandoning the conventional approach, <i>Forrest Higgs</i>	P.1149
11th	Kitty Warning!, <i>Vik Olliver</i>	P.1151
14th	Direct drive turns out to be the best, <i>Forrest Higgs</i>	P.1152
15th	Drink Bottle Feedstock, <i>Adrian Bowyer</i>	P.1153
16th	Announcing MakerBot Industries, <i>Zach Smith</i>	P.1155
17th	Wedgewood Update - Z Axis Begins, <i>Vik Olliver</i>	P.1157
21st	Thermoplast Extruder Version 2.0 Released, <i>Adrian Bowyer</i>	P.1158
23rd	RRRF Prototyping Service Launched!, <i>Zach Smith</i>	P.1159
23rd	Wire nozzle, <i>eD</i>	P.1160
29th	Wedgewood Update - Z axis in place, X begins, <i>Vik Olliver</i>	P.1162

April 2009

1st	more WeDge, <i>eD</i>	P.1163
1st	Ed Sells, <i>Adrian Bowyer</i>	P.1165
2nd	Now Available: Stepper Motor Driver v2.3, <i>Zach Smith</i>	P.1166
5th	A gripping read, <i>nophead</i>	P.1168
9th	RepRap hits Parliament, <i>eD</i>	P.1173
9th	Cheap linear bearing hack, <i>eD</i>	P.1175
11th	By your powers combined, I am KAPTON PLANET, <i>Zach Smith</i>	P.1176
12th	Getting a handle on milling accuracy, <i>Forrest Higgs</i>	P.1178
13th	Get your stepper to put splines on its own shaft, <i>Adrian Bowyer</i>	P.1182
18th	Bowden extruder concept, <i>eD</i>	P.1184
19th	First rewrapped circuit, <i>Adrian Bowyer</i>	P.1186
20th	Introducing the Extruder Controller v2.2, <i>Zach Smith</i>	P.1188
22nd	Wedgewood X Assembly, Thumbnail Edition, <i>Vik Olliver</i>	P.1190
23rd	Skeinforge Support, <i>Ian Adkins</i>	P.1191
29th	Introducing the RepRap Motherboard v1.x, <i>Zach Smith</i>	P.1193
29th	DIY chip fab, <i>Adrian Bowyer</i>	P.1195
30th	A different approach to extrusion, <i>Forrest Higgs</i>	P.1196

May 2009

3rd	Documenting the Mk I Nutjob, <i>Forrest Higgs</i>	P.1199
3rd	Stovetop recycling of HDPE swarf, <i>Forrest Higgs</i>	P.1207
5th	Taking the Gm-17 out of Nophead's GM-17/tin can stepper hack, <i>Forrest Higgs</i>	P.1210
7th	4D Printing, <i>Adrian Bowyer</i>	P.1212
11th	The No-Lathe Barrel & Nozzle, <i>Vik Olliver</i>	P.1214
13th	Sourceforge Award Nomination, <i>Vik Olliver</i>	P.1219
14th	No-Lathe Extruder Pops Out, <i>Vik Olliver</i>	P.1220
15th	Small Melt Zones Look Good, <i>Vik Olliver</i>	P.1221
15th	Some notes on the way to an easy-to-make pinchwheel extruder, <i>Forrest Higgs</i>	P.1223
18th	Fun Night at MakerBot, <i>Zach Smith</i>	P.1229
26th	Accelerating RepRap, <i>Adrian Bowyer</i>	P.1230
26th	I2C-based Reprap control, <i>Forrest Higgs</i>	P.1232

June 2009

1st	Bowden extruder success!!, <i>eD</i>	P.1244
6th	Tommelise 3.0 I2C board finally built, <i>Forrest Higgs</i>	P.1246
12th	RepRap wins at Bath University, <i>eD</i>	P.1248
13th	Acceleration Code Released, <i>Adrian Bowyer</i>	P.1249
17th	Sourceforge awards, <i>Adrian Bowyer</i>	P.1250
24th	SourceForge Community Choice Awards, <i>Adrian Bowyer</i>	P.1251
28th	Tamiya Universal Extruder, <i>Vik Olliver</i>	P.1252

July 2009

1st	Stepper driver for Extruder Controller V2.2, <i>Adrian Bowyer</i>	P.1253
2nd	No-lathe extruder interior, <i>Vik Olliver</i>	P.1254
9th	RepRap Main Website Outage - Updated, <i>Vik Olliver</i>	P.1255
11th	Stripboard Design App, <i>Forrest Higgs</i>	P.1256
18th	High-rise RepRaps, <i>Vik Olliver</i>	P.1257
19th	[No Title], <i>Zach Smith</i>	P.1258
19th	Dancing shoes, <i>Adrian Bowyer</i>	P.1259
20th	RepStrapping Open Source Ecology, <i>nophead</i>	P.1260
20th	The Cable Tie Track Trick, <i>Vik Olliver</i>	P.1261
26th	Build Quality, <i>Adrian Bowyer</i>	P.1263
28th	The RepRap Clock, <i>Adrian Bowyer</i>	P.1265

August 2009

1st	Battle of The Bulge pt2, <i>Vik Olliver</i>	P.1266
3rd	RepRap, the book, <i>eD</i>	P.1268
6th	[No Title], <i>Zach Smith</i>	P.1269
7th	ReplicatorG 0006 Available, <i>Zach Smith</i>	P.1270
9th	Slicing and dicing with image processing, <i>Forrest Higgs</i>	P.1272
14th	Simple PWM Output Design - Spoodriver, <i>Vik Olliver</i>	P.1273
17th	RepRap at Hacking at Random 2009, <i>Adrian Bowyer</i>	P.1274
21st	Buying a Rapman, <i>Forrest Higgs</i>	P.1275
21st	Mendel Sighted In The Wild, <i>Vik Olliver</i>	P.1276
26th	Wedge progress, <i>eD</i>	P.1277
27th	Mendelssohn Update, <i>Vik Olliver</i>	P.1279
30th	Giving Mendel Teeth, <i>Adrian Bowyer</i>	P.1280
30th	Mendelssohn Z axis operational, <i>Vik Olliver</i>	P.1283

September 2009

1st	Mendelssohn Y axis operational, <i>Vik Olliver</i>	P.1284
9th	Darwin vs Wedge, the numbers, <i>eD</i>	P.1285
14th	Software Freedom Day 2009, <i>Vik Olliver</i>	P.1287
17th	Mendel Apollo, <i>eD</i>	P.1288
25th	My Extruder Doesn't Work. What Can I Do?, <i>Vik Olliver</i>	P.1290

October 2009

2nd	Mendel's first print!, <i>eD</i>	P.1291
4th	Hello World, <i>Rhys Jones</i>	P.1292
7th	Getting ready for Mendel, <i>Adrian Bowyer</i>	P.1294
13th	Mendel Uploaded!, <i>eD</i>	P.1295
14th	MakerBot Love, <i>Adrian Bowyer</i>	P.1297
14th	Copper Plating Wire Glue, <i>Rhys Jones</i>	P.1298
14th	Costing Mendel, <i>eD</i>	P.1301
19th	Printing in space?, <i>eD</i>	P.1302
25th	The RepRap Factory, <i>Adrian Bowyer</i>	P.1303
27th	RepRap Extruder Design with OpenSCAD, <i>Wizard23</i>	P.1304

November 2009

3rd	An end to ooze and support material found ..., <i>nophead</i>	P.1306
5th	An end to ooze II, <i>Adrian Bowyer</i>	P.1309
9th	Rack and pinion, <i>Forrest Higgs</i>	P.1310
10th	Reprapable Solar Power, <i>Adrian Bowyer</i>	P.1312
11th	Guying long prints, <i>Forrest Higgs</i>	P.1313
11th	I found a bug!, <i>Vik Olliver</i>	P.1316
12th	Continued guying, <i>Forrest Higgs</i>	P.1317
14th	Revisiting HDPE, <i>Forrest Higgs</i>	P.1320
15th	More printing large objects with HDPE, <i>Forrest Higgs</i>	P.1323
15th	Bogdan's acid test, <i>Forrest Higgs</i>	P.1324
16th	Pathetic Fallacy, <i>Adrian Bowyer</i>	P.1332
16th	Making spares for Rapman, <i>Forrest Higgs</i>	P.1334
21st	Moving towards production, <i>Adrian Bowyer</i>	P.1338
21st	Mac Goes RepRap (one day...), <i>Adrian Bowyer</i>	P.1339
24th	Bugs Brew PLA Direct, <i>Vik Olliver</i>	P.1340

December 2009

1st	The March of the Mendels, <i>Adrian Bowyer</i>	P.1341
2nd	Soluble Support Material, <i>Rhys Jones</i>	P.1342
4th	RepRap Goes To School, <i>Vik Olliver</i>	P.1344
5th	Metal bits from a RepRap, <i>Vik Olliver</i>	P.1345
5th	Can we print belts?, <i>Forrest Higgs</i>	P.1347
5th	Killing flocks of birds with one stone, <i>Forrest Higgs</i>	P.1350
7th	RepRap'd Art Exhibition, <i>Vik Olliver</i>	P.1354
8th	Got it!, <i>Forrest Higgs</i>	P.1355
8th	Got it!, <i>Forrest Higgs</i>	P.1356
9th	z-leadscrew-base-bar-clamp_2off, <i>Forrest Higgs</i>	P.1359
10th	ABS works, too., <i>Forrest Higgs</i>	P.1363
18th	Brute force stepper controller, <i>Forrest Higgs</i>	P.1364

January 2010

1st	New Year New Plastic, <i>nophead</i>	P.1367
14th	A printable, high speed alternative to belts?, <i>Forrest Higgs</i>	P.1368
24th	New Software - May Contain Nuts..., <i>Adrian Bowyer</i>	P.1374

26th	Getting there with herringbone rack and pinion, <i>Forrest Higgs</i>	P.1377
27th	Build a better RepRap: \$80,000 Prize, <i>Adrian Bowyer</i>	P.1379
27th	Upcoming server outage, <i>Sebastien Bailard</i>	P.1380
29th	Paste Extruder - The first test, <i>Rhys Jones</i>	P.1381
30th	Mendelssohn & LCA2010, <i>Vik Olliver</i>	P.1384
31st	Many useful little things..., <i>Forrest Higgs</i>	P.1386

February 2010

1st	Brass Tube Extruder Update, <i>Vik Olliver</i>	P.1392
2nd	Multiple object saving and loading, <i>Adrian Bowyer</i>	P.1393
3rd	Mini Me, <i>Adrian Bowyer</i>	P.1394
6th	Testing the envelope, <i>Forrest Higgs</i>	P.1396
10th	Full Colour RepRap?, <i>Adrian Bowyer</i>	P.1399
16th	RepRapping at the Maker Faire, Newcastle - March 13-14, 2010, <i>Sebastien Bailard</i>	P.1401
22nd	Broadening RepRap Participation, <i>Adrian Bowyer</i>	P.1402
25th	The Balls Return, <i>Vik Olliver</i>	P.1403
27th	Drilling the extruder barrel, <i>Vik Olliver</i>	P.1404
28th	Slice and Dice 0.1, <i>Forrest Higgs</i>	P.1405

March 2010

1st	Erik de Bruijn's RepRap Survey, <i>Adrian Bowyer</i>	P.1409
2nd	New Release, <i>Adrian Bowyer</i>	P.1410
2nd	Printing light structures, <i>Forrest Higgs</i>	P.1412
2nd	Some crude load tests, <i>Forrest Higgs</i>	P.1415
5th	Making Mendels, <i>Adrian Bowyer</i>	P.1420
7th	Reprappable electronics, <i>Adrian Bowyer</i>	P.1422
8th	Heated Bed and post-McWire Design Sprints! (Marathons?), <i>Sebastien Bailard</i>	P.1424
10th	Google's Summer of Code, <i>Sebastien Bailard</i>	P.1425
12th	Bowden Paste Extruder, <i>Rhys Jones</i>	P.1426
14th	Tiny ball-chain gears, <i>Vik Olliver</i>	P.1427
16th	RepRap in Singapore! (New RepRap User Group), <i>Sebastien Bailard</i>	P.1429
19th	No peel, no warp, no backlash, <i>Forrest Higgs</i>	P.1431
21st	Yet Another Geared Extruder, <i>Adrian Bowyer</i>	P.1435
21st	Stacking slices to make simple boolean unions, <i>Forrest Higgs</i>	P.1436
25th	Let's Go To The Faire!, <i>Sebastien Bailard</i>	P.1438
30th	Best of both Worlds, <i>Bogdan Kecman</i>	P.1440
30th	Our Extruders Hardly Ever Catch Fire, <i>Vik Olliver</i>	P.1444

April 2010

1st	[No Title], <i>Sebastien Bailard</i>	P.1445
3rd	Hot copper and PLA, <i>nophead</i>	P.1447
18th	Fab At Home, <i>Adrian Bowyer</i>	P.1448
19th	Where it all began..., <i>Adrian Bowyer</i>	P.1449
22nd	RepRap Talk and Demonstration in Cardiff, UK, <i>Adrian Bowyer</i>	P.1450
24th	RepRap the Lawgiver..., <i>Adrian Bowyer</i>	P.1451
29th	Bay Area Maker Faire Reminder!!!, <i>Sebastien Bailard</i>	P.1452

May 2010

2nd	Board Supports, <i>Vik Olliver</i>	P.1453
12th	A Heated Bed for Mendel, <i>Adrian Bowyer</i>	P.1455
15th	Quick hot bed temperature controller..., <i>Bogdan Kecman</i>	P.1458
20th	An Open-Source Scanning Tunneling Microscope, <i>Adrian Bowyer</i>	P.1460
22nd	Mendel Variations and Lasers!!!, <i>Sebastien Bailard</i>	P.1462
25th	RepRap Talk - Bogota, <i>Adrian Bowyer</i>	P.1463
29th	Major New Scientist RepRap Article, <i>Adrian Bowyer</i>	P.1464

June 2010

10th	Inkjet RepRap, <i>Adrian Bowyer</i>	P.1465
16th	Reprap Aggregation Pipe - V2 update, <i>Buzz</i>	P.1467
20th	Yet another extruder nozzle..., <i>Adrian Bowyer</i>	P.1468
21st	Vectorization of pixel defined print roads, <i>Forrest Higgs</i>	P.1470
28th	New Release, <i>Adrian Bowyer</i>	P.1474

July 2010

6th	Vectorization of pixel defined print roads actually working properly, <i>Forrest Higgs</i>	P.1475
8th	Overhang support and PCBs, <i>Adrian Bowyer</i>	P.1477
16th	RepRap in the Year 3000, <i>Adrian Bowyer</i>	P.1478
17th	Mendel & multiple materials, <i>Rhys Jones</i>	P.1479
23rd	Glow-in-the-dark PLA, <i>Vik Olliver</i>	P.1482
26th	Memories of plastic model airplanes, <i>Forrest Higgs</i>	P.1483
28th	Some thoughts and observations about having a Reprap machine in the design cycle, <i>Forrest Higgs</i>	P.1485
29th	Continuous belt production, <i>Adrian Bowyer</i>	P.1488
31st	Towards reprogrammable electronics, <i>Adrian Bowyer</i>	P.1490
31st	We're Going to the Faire!, <i>Sebastien Bailard</i>	P.1491

August 2010

4th	Applying VTEC to Slice and Dice, <i>Forrest Higgs</i>	P.1492
5th	Reprapping two materials into one object, <i>Rhys Jones</i>	P.1495
7th	Improving print roads calculations, <i>Forrest Higgs</i>	P.1496
9th	RepRap is going to the NYC Maker Faire!, <i>Sebastien Bailard</i>	P.1501
31st	RepRap Version III "Huxley", <i>Adrian Bowyer</i>	P.1504

September 2010

2nd	A Smarter Approach to Infill, <i>Rhys Jones</i>	P.1505
6th	Wondering what the fuss is about, <i>Forrest Higgs</i>	P.1507
11th	RepRap repraps RepRap electronics, <i>Adrian Bowyer</i>	P.1509
16th	Mendel Drawing, <i>Adrian Bowyer</i>	P.1511
16th	Dealing with detaching rafts, <i>Forrest Higgs</i>	P.1512
26th	Dem Bones, <i>Forrest Higgs</i>	P.1513

October 2010

4th	Story of simpler Mendel: PLA bushings and X-axis, <i>prusajr</i>	P.1521
-----	--	--------

10th	Replicating laser-cut parts, <i>Forrest Higgs</i>	P.1527
13th	Story of simpler Mendel: Y and Z axes, <i>prusajr</i>	P.1539

November 2010

6th	The Gada Prize, <i>Adrian Bowyer</i>	P.1545
10th	3D printing and "Intellectual Property", <i>Adrian Bowyer</i>	P.1546
26th	Random thoughts on hot-end design, <i>Bogdan Kecman</i>	P.1547

December 2010

8th	ReplicatorG for RepRaps: Beta testers wanted, <i>D1plo1d</i>	P.1548
14th	Reprappable Inkjet Head, <i>Adrian Bowyer</i>	P.1551
16th	ABS Multicolor Printing, <i>D1plo1d</i>	P.1553
24th	A proper conductive polymer mix?, <i>Forrest Higgs</i>	P.1554
26th	Pretty outside, ugly inside, <i>prusajr</i>	P.1557

January 2011

2nd	Belt drivn extruder, <i>Buzz</i>	P.1559
9th	Evolving the Prusa Mendel: Part 1, <i>D1plo1d</i>	P.1560
10th	The Emerging Economy of Home Manufacturing, <i>Adrian Bowyer</i>	P.1562
13th	RepRap MicroExtruder, <i>Adrian Bowyer</i>	P.1563
24th	Filling in with the fillings, <i>Vik Olliver</i>	P.1564
24th	Evolving the Prusa Mendel: Part 2, <i>Christopher Olah</i>	P.1565
26th	Conductive pastes take 453, <i>Rhys Jones</i>	P.1567
27th	Improved Huxley design, <i>Adrian Bowyer</i>	P.1568

February 2011

5th	RepRap Calculator, <i>prusajr</i>	P.1569
5th	Thermocouple vs Thermistor, <i>prusajr</i>	P.1570
14th	Printing small holes in small features, <i>Forrest Higgs</i>	P.1572

March 2011

1st	Going for 32 bit embedded processors, <i>Forrest Higgs</i>	P.1578
2nd	Printing People, <i>Adrian Bowyer</i>	P.1583
3rd	RepRap Universal Mini Extruder, <i>Adrian Bowyer</i>	P.1584
4th	First Dutch Reprap Build-Party, <i>Adrian Bowyer</i>	P.1586
4th	High-Impact PLA, <i>Vik Olliver</i>	P.1587
5th	High Impact Test, <i>Vik Olliver</i>	P.1588
7th	3D Printed Adult's Bicycle, <i>Vik Olliver</i>	P.1590
8th	Impartial reievew of the Clonedel Cast parts by Metrix Create Space, <i>Neil Underwood</i>	P.1591
10th	Development board arrived, <i>Forrest Higgs</i>	P.1592
11th	Best of the RepRap Wiki 3/11/11, <i>Neil Underwood</i>	P.1595
11th	Aha! RepRap appears do be doing MakerFaire!, <i>Sebastien Bailard</i>	P.1600
15th	Double Wade sighted in the workshop, <i>Vik Olliver</i>	P.1602
16th	Automatic documentation and project evolution, <i>prusajr</i>	P.1603
18th	Best of the RepRap Wiki 3/18/11, <i>Neil Underwood</i>	P.1607
23rd	Print a Vacuum Cleaner!, <i>Christopher Olah</i>	P.1611

26th	Best of the RepRap Wiki 3/25/11, <i>Neil Underwood</i>	P.1612
28th	Extending OpenSCAD, <i>Christopher Olah</i>	P.1615

April 2011

3rd	This week In The Wikii 4/02/11, <i>Neil Underwood</i>	P.1616
4th	Be your own souvenir, <i>Adrian Bowyer</i>	P.1625
10th	Sourcing a 3d Printer, <i>Neil Underwood</i>	P.1626
14th	Big RepRap Refereed Journal Article, <i>Adrian Bowyer</i>	P.1634
18th	Rewriting history, <i>Adrian Bowyer</i>	P.1635
22nd	New Extruder Design, <i>Adrian Bowyer</i>	P.1637
27th	UK RepRap Master Class, <i>Adrian Bowyer</i>	P.1639
27th	Sampo: The return of Darwin..., <i>Forrest Higgs</i>	P.1641

May 2011

2nd	3D/DC, <i>Wade Bortz</i>	P.1647
8th	Thermal goodness, <i>prusajr</i>	P.1651
9th	Solid prints, <i>Forrest Higgs</i>	P.1652
10th	Never Mind the Width, Feel the Quality, <i>Adrian Bowyer</i>	P.1657
15th	Refighting the String Wars., <i>Forrest Higgs</i>	P.1658
22nd	Baltimore RepRap Master Class, <i>Neil Underwood</i>	P.1665
24th	Winding up the String Wars, <i>Forrest Higgs</i>	P.1666
25th	Selectively making parts of object stronger, <i>prusajr</i>	P.1669
29th	Moving RepRap from Subversion to Git, <i>Adrian Bowyer</i>	P.1670
29th	Stepping into firmware, <i>Forrest Higgs</i>	P.1671

June 2011

1st	The end of the String Wars, <i>Forrest Higgs</i>	P.1676
5th	Unreasonable Rocket's 3d Printed Rocket Engine Takes Flight!, <i>Neil Underwood</i>	P.1678
8th	Prusa Felt branch and ThingDOC, <i>prusajr</i>	P.1679
11th	Founder's Forum, <i>Adrian Bowyer</i>	P.1682
12th	Getting Rid of Mendel's Nuts, <i>Vik Olliver</i>	P.1683
12th	Around the RepRap Community, <i>Neil Underwood</i>	P.1685
14th	A "string wars" approach to the y-axis, <i>Forrest Higgs</i>	P.1690
21st	Reprap at the NextGen Science Fair 2011 in San Francisco, <i>Forrest Higgs</i>	P.1693
24th	A new approach to printing metals, <i>Rhys Jones</i>	P.1699

July 2011

5th	Picking up speed, <i>Forrest Higgs</i>	P.1707
16th	Surface-Oriented CAD, Math, & Telescopes, <i>Christopher Olah</i>	P.1708
16th	Around the RepRap Community 07/15/2011, <i>Neil Underwood</i>	P.1709
20th	Mendel's Birthday, <i>Vik Olliver</i>	P.1714

August 2011

7th	Around the RepRap Community 08/06/2011, <i>Neil Underwood</i>	P.1715
20th	Still Extruding: Installing Pronterface and SFact in Windows, <i>Neil Underwood</i>	P.1720
24th	Still Extruding: RepRap Price Points, <i>Neil Underwood</i>	P.1721

September 2011

- 8th Michael S. Hart, e-book inventor and Project Gutenberg founder, dies at 64, *Forrest Higgs* P.1724
- 8th Being in a 3D world, with a 3D printer? what do I need? A 3D scanner!, *Buzz* P.1725
- 9th A Tipping Point of Print Quality (Open Source for the win), *Neil Underwood* P.1728

October 2011

- 1st Hear Adrian Bowyer on BBC Radio, *Adrian Bowyer* P.1730
- 5th Still Extruding: Catching up, *Neil Underwood* P.1731
- 6th 3D Systems Print Quality Mixup, *Neil Underwood* P.1732
- 14th RepRap Meeting in Bath, *Adrian Bowyer* P.1735
- 19th Say goodbye to unsightly STL triangle misery! Forever!, *Adrian Bowyer* P.1736

November 2011

- 11th Prusa Iteration 2, *prusajr* P.1738
- 16th Playing Fast & Loose, *Vik Olliver* P.1743
- 27th Reprap Prusa Iteration 2 Build Event in Cologne Germany in December, *Neil Underwood* P.1744
- 28th Around the RepRap Community 11/28/2011, *Neil Underwood* P.1746
- 29th Quality - Open Source for the Win (Part Deux), *Adrian Bowyer* P.1751

December 2011

- 16th Solving a nagging question about print adhesion, *Forrest Higgs* P.1753
- 27th 0.01 Layer Height on a Prusa Mendel, *Neil Underwood* P.1758

RepRap

Wednesday, 23rd March 2005 by Adrian Bowyer

This is the blog for the [RepRap project](#). See that link for details.

This blog has a threefold purpose:

1. To solicit and to acknowledge contributions to the RepRap project from other researchers,
2. To get project ideas into the public domain as soon as possible, to ensure that they are unpatentable, and
3. To act as a project diary.

As a consequence of Item 2, in particular, some items are a bit scrappy and provisional.

If you have something to contribute, please get in touch. But understand that all solutions offered must be open-source and free (as in not costing anything, as well as in freedom...).

Software

We may be using the results of the [OpenRP project](#) as a way of storing and transmitting RP designs. (Thanks to Sven Johnson for drawing OpenRP to our attention.) Check out that link for details.

Likewise, the RepRap RP machine will probably be using the software from the [LinuxCNC project](#) for its control. (Thanks to Josh Storrs Hall for drawing LinuxCNC to our attention.) Check out that link for details.

One thing we need is an open-source 3D CAD system that can output OpenRP format or STL files; we'd give it away with the machine. Our own [Svlis geometric modeller](#) is too experimental (i.e. fancy, but buggy...), so we're looking at [BRL-CAD](#), which is a robust geometry engine. But its user-interface needs a lot of work... Another possibility is [VTK](#) (thanks to Deelip Menezes of the OpenRP project for the suggestion), and another is [Blender](#) and [BlenderCAD](#) (thanks to Michael van der Linden for that one).

We probably don't need anything with very complicated geometry (we're unlikely to need NURBS surfaces, for example). We could probably manage with just planes, spheres, cylinders, cones, helices, and tori. Those, together with sketch-and-extrude and sketch-and-revolve functions, and the ordinary CSG operators should just about do.

We might also look at the various Povray scene editors that there are out there. One piece of

software (thanks to Vik Olliver for the suggestion) is Art of Illusion; we'll look into this.

[Click here if you have another solution to our CAD problem.](#)

Our current intention for RepRap is to put a microcontroller in the machine itself (probably a PIC) to control motors, temperatures, and timings, and to have all the smart stuff happening on the USB-connected PC. The code will be open-source, of course. And, though we'll almost certainly do all our development under Linux (probably in C++ or Java), we acknowledge that realistically it'll have to run on Windows as well.

Materials

We may use thermoset polymers, or thermoplastics. The big problem with thermosets is recycling (see Background to the Bath RepRap Project), as they need a lot of energy to break down back into a monomer because you have to bust lots of covalent bonds. Thermoplastics are much easier, because they can be dissolved or melted and (more or less) you only have to overcome van der Waals forces. So we have a strong long-term incentive to go for the latter. However, the short-term get-the-thing-working incentive is towards the former...

For electrical conductors we may use Wood's metal, or conducting fillers in polymers.

Something that looks particularly promising is a mixture of bis-phenol-2 bis(2-hydroxypropyl) methacrylate [Bis GMA] and tri(ethylene glycol) dimethacrylate [TEGDMA] monomers with a camphoroquinone photoinitiator and a tertiary amine as a reducing agent. Added to that would be a filler (probably glass particles of a few microns in size). All this is a fancy way of saying dentists' white filling material, and it has the following advantages:

1. It is benign - dentists put it in your mouth...
2. It is dimensionally stable - it doesn't change volume when it sets
3. It is stiff - when laid down it retains its shape against gravity
4. It can be polymerised with light from blue LEDs - [see this link](#)
5. It is tough and hard-wearing.

We have an RP design for a syringe pump - see below - and this would be ideal for applying this material. We suspect that, if we use dendritic silver as an alternative filler, it will make a good electrical conductor too.

Other materials we are looking at are ABS, PVA (which is water soluble), and DuPont's Elvamide nylon multipolymer resin (which is soluble in alcohols).

Of course, if we decide to go with thermoplastics, we also get thermosets for free, as we can use RepRap to make a thermoplastic mould in which to cast the thermoset (or plaster, or ceramic slip...). All these latter can go up to high temperatures if need be, unlike the thermoplastic.

Hardware

The vast majority of existing rapid prototyping machines work using Cartesian X, Y, Z coordinate axes. This is an obvious way to do things, but we think that it may be better to make a polar machine that has a radial arm, a turntable, and movement along the axis of the turntable. This would have a number of advantages, the two principal ones being that it would be easier to make the machine itself accurately, and that - when working - it would manufacture much higher-quality rotationally-symmetric parts. It is no accident that the lathe was invented before the milling machine...

At the moment we are looking at the possibility of such a machine that will build by depositing a thin stream of material from a syringe pump, creating the design up layer by layer. We will actually have two streams - one an electrical insulator, the other a conductor, plus possibly a third for support material for overhangs.



The RP syringe pump. The only non-RP parts are the syringe (which only costs a few pence), a length of M5 studding plus an M5 nut, four M3 screws, and the motor (245-6089; available from [RS Components](#) - click the link). We have a later versions with an optical counter on the motor shaft for precise metering, with heating jackets, and a whole range of different capacity syringes.

An alternative to the support material is to use the build material itself as a support, which then

gives the problem of separating the two. One way to do this is geometrically - we would have the computer ensure that the points where the support touched the built object were thin and weak, and so it would break away easily. Another it to have a third deposition head that puts down a very thin layer of release agent on the top of any support, so the build doesn't stick to it. We suspect vegetable oil will work well for this.

Moving away from syringe-metered deposition, and slightly crazily, there's also the possibility of wiping a flat thin layer of thermoset paste over the entire build area, then polymerising the shapes needed in the whole layer at once by shining a (UV or visible) light through an image on a data-projector LCD to project that image on the layer. This would be very fast. Then we'd add the next layer, and so on. Problem is: the machine couldn't make a (doubtless expensive) LCD to replicate itself. We are happy to include cheap widely-available bought-in parts (screws, washers, microelectronic chips, and the odd electric motor), but not expensive ones.

P.S. 26 March 2005: There is such a machine already. The machine is pretty neat, and also low cost. Check it out at [Envisiontec](#), who use a mirror chip (like the ones in cinema projectors) rather than an LCD.

A possible variation on this is to deposit a thermoset paste film, to set it by scanning a blue/UV LED over it, to wash away the un-polymerised paste, and then to go on to the next layer.

As to the base on which the build starts, the current plan is to have a perforated flat plate with a partial vacuum behind it holding down a sheet of ordinary kitchen aluminium foil upon which the build will be initiated. No need for a vacuum pump, of course - just attach a venturi to a water tap as chemists have been doing for centuries.

Measurement and calibration - we are confident that we can rapid prototype repeatable (if not accurate) linear axes. The repeatability means that - if we can calibrate them - the computer can keep a map, and thus make them accurate as well. But we need a cheap way to get a digital readout to 0.1mm (or better) of displacement over a range of at least 300mm. We are currently experimenting with Moire fringes (which one can print easily on an inkjet printer), with a modified design of an LVDT that we came up with in response to the problem, and the capacitively-linked "comb" patterns that are used in digital measuring callipers (**CHEAT WARNING** these are now so cheap - [check here](#) - that we may be tempted to use them in the first version of the machine...). But if you can think of a better way, that would be most welcome.

What's the LVDT idea? Well, conventional LVDTs are wonderfully accurate (and linear - hence the L...), and it's pretty easy to make one. But they take up much more room than the displacement they measure. Ideally, we need something not much more than 300 mm long to measure 300mm. So the idea is to take the LVDT core out and wrap it round the outside instead, and to have multiple coils instead of just three, switched in sequence by the controlling electronics. It would go something like this:

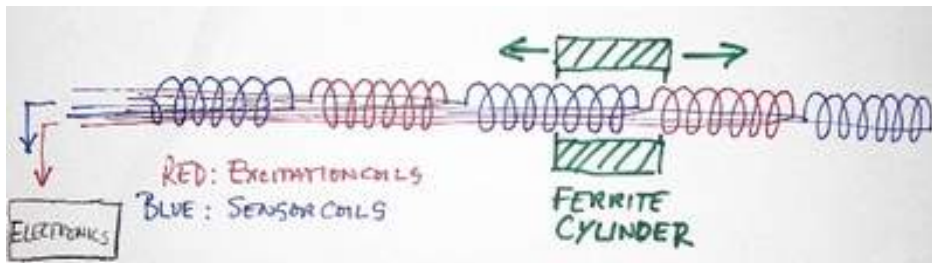

You could keep adding alternate excitation and sensor coils on the right-hand end to cover any length you like. Note that all the wires come out the left end, meaning that it's easy to assemble into a design because the right hand end is always free. When it's switched on, the microcontroller in charge can find the cylinder (which is the thing having its movement measured) simply by energising each excitation coil in turn. The whole device then acts like a chain of LVDTs that's as long as you like. Each separate section would probably need different calibration data, but remembering that sort of stuff is what computers are for. It may even be possible to wire it up simply without switching electronics and still pick up position accurately:

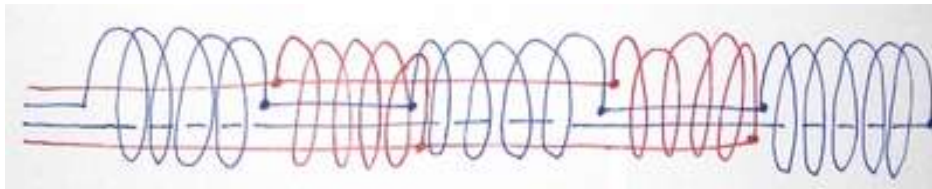

[Click here if you have another solution to our measurement and calibration problem.](#)

[No Title]

Thursday, 24th March 2005 by Adrian Bowyer

Neat suggestion from John Davis: use optical encoder strips from Precision Images to solve the measurement problem; they cost about \$2 each and will resolve down to 0.05mm. Agilent make the sensors for around \$10, part number HEDS-9720-P50.

[No Title]

Saturday, 26th March 2005 by Adrian Bowyer

Lay down white polymer powder for sintering as in SLS, but run an inkjet printer head over it as in the MIT system. In contrast to that, though, in the printhead there is a substance pretty rare in RP printheads, namely black inkjet printer ink. Behind the printhead you have a strip-heater the width of the scan. Now, the black printed-on powder will absorb more heat than the white, so you adjust the strip-heater temperature until the black powder just sinters and the white stays raw.

This is the opposite of Selective Inhibition Sintering.

A quartz-halogen heater would probably be best.

It might be a good idea if the ink did not wet the powder, as that way you would get a denser black because it would not soak in.

You may also have to flood the thing with CO₂ or N₂ to stop oxidation.

P.S. (6 April 2005): This is patented by Loughborough University, so we'll leave work on it to them.

[No Title]

Friday, 1st April 2005 by Adrian Bowyer

Another powder-printing possibility: inkjet pure water onto hemihydrated calcium sulphate (i.e. plaster of paris - or maybe instead even Portland cement... possibly mixed with a fibre filler for strength). The CaSO_4 solidifies in a few minutes.

Alternatively inkjet a solvent to fuse a powder; PVA and water might work quite well, or virtually any thermoset and a corresponding organic solvent for it. Thermosets dissolving in propanone (acetone) might be good, as propanone has a high vapour pressure and so would evaporate quickly and is not that toxic in a well-ventilated area (it's nail varnish remover).

[No Title]

Monday, 4th April 2005 by Adrian Bowyer

We quite like the idea of building an extra head into an FDM system to dispense polydimethylsiloxane (PDMS - bathroom sealant) together with an optically-triggered crosslinking agent; that way we could make components from rigid insulators, rigid conductors, and a synthetic rubber all integrated together.

[No Title]

Wednesday, 6th April 2005 by Adrian Bowyer

Polymorph might be a useful material. It's a nylon-like polymer that melts around 60oC.

[No Title]

Friday, 8th April 2005 by Adrian Bowyer

An extrusion head that co-extrudes a thin copper wire filament together with a polymer (like a miniature version of the way that ordinary electrical wires are made) to form electrical connections. The extrusion would bind in with the rest of the RP part.

[No Title]

Wednesday, 13th April 2005 by Adrian Bowyer

Vik Olliver has just sent us pictures of his marvellous Meccano and glue-gun RP material deposition system. Here they are:

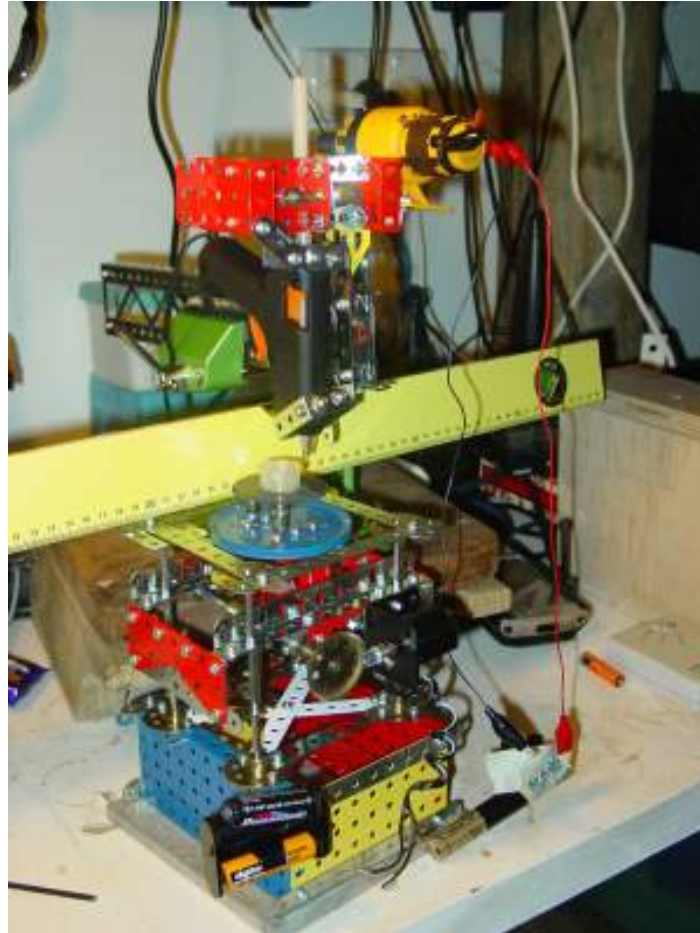

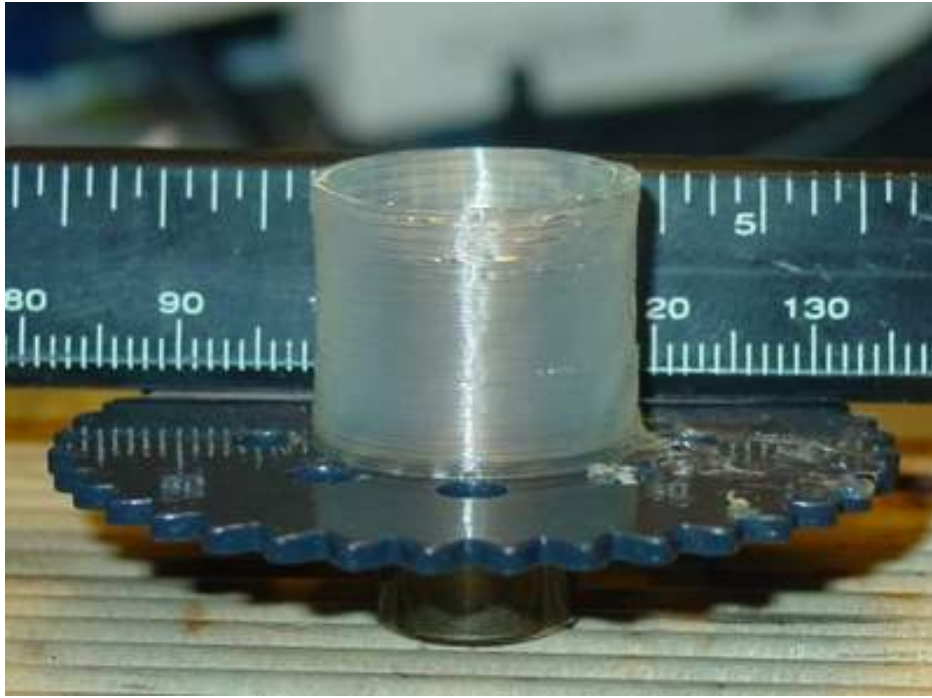

He made this and got it working in six days. He managed to get a 19.5mm diameter tube with a wall thickness of 0.85mm and a height of 16.5mm, and is writing a more detailed description which he has kindly agreed to allow us to post on this site. Glue guns use ethylene-vinyl acetate as a working material, incidentally. Just Araldite a fine very short hypodermic needle into the end of the glue gun, and add some servo axes and a computer...

15 April 2005: Vik has just sent us a [draft copy of his report](#). It's also available from [Reports and Documentation](#) at www.reprap.org.

[No Title]

Thursday, 14th April 2005 by Adrian Bowyer

More input on the CAD question from Paul (no surname...):

<http://www.opencascade.org/>

<http://www.tech.oru.se/cad/varkon>

<http://www.tech-edv.co.at/linux/MODlinks.html>

The problem with OpenCascade may be the same as that for BRLCAD - namely that it's a good geometry engine but needs a user interface. The other two links look useful.

And from Sven Johnson there's:

<http://www.openarchitect3d.org>

<http://www.openfx.org/> and

<http://www.pppmodeler.com/>

And some more neat stuff from Vik Olliver, this time on electrical conductors interfacing with chips. To quote him:

"I wondered if it might be practical to lay down one layer of relatively soft plastic such as EVA, which only needs to be in the places that will be occupied by tracks. A conductive silver paint pen:

<http://www.dse.co.nz/cgi-bin/dse.storefront/en/product/N5184>

is then run across the tracks. The layer is allowed to cure, and is covered with another protective layer of softer plastic. The board substrate is then printed over the top of the tracks, with holes left where component legs are expected to go.

"Once the board is peeled off the base platform (or a very thin non-conductive layer of platform protectant such as PVC film might be used as the first layer), components can be pushed through the face bearing the tracks, forming a contact between the trapped conductive layer and the component legs.

"The paint also has applications for printing non-durable switch contacts, though a conductive

elastomer might be more appropriate.

"Printing the track in plastic first reduces the dependence on the size of the paint pen tip for track width.

I suspect that it might be possible to print a simple digital circuit such as a calculator/PDA using a PIC, printed keyboard, and a serial LCD for the display - all in a snap-fit case."

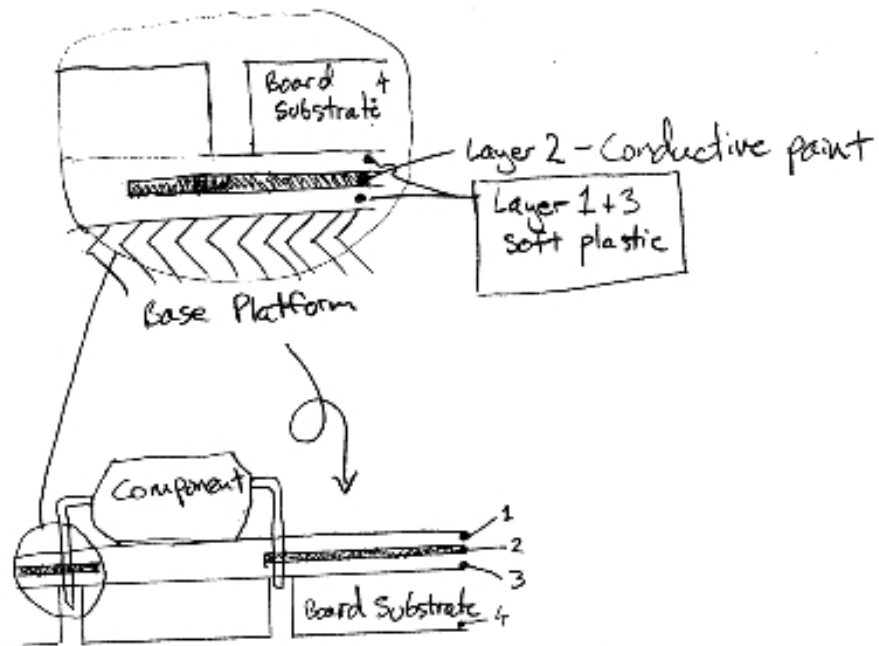

[No Title]

Friday, 15th April 2005 by Adrian Bowyer

A brief experimental result on the idea of using release agent to separate supports from built objects in FDM. We had our Stratasys Dimension FDM machine make a 10mm ABS cube, paused the build about one third the way through, opened the machine, and painted a thin film of vegetable oil (Tesco's own-brand Corn Oil, to be precise) on the top surface. We then resumed the build, which proceeded as normal.

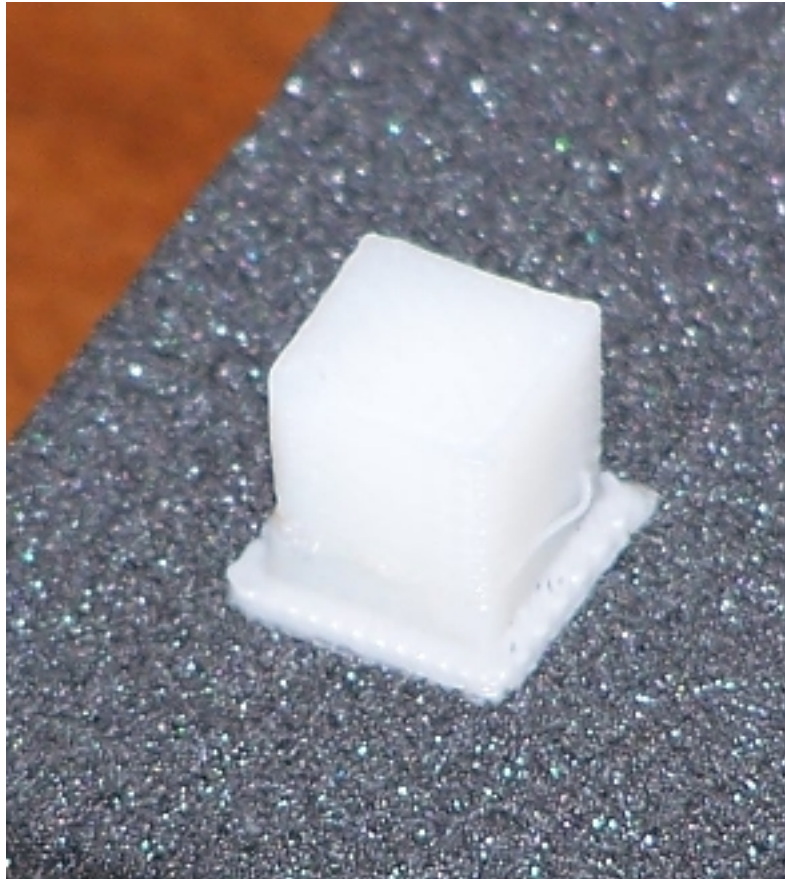

The first picture shows the finished cube. (The mistake loop is irrelevant - it is about four layers below the split.) The cube split cleanly (second picture) where the oil had been deposited, needing a small but definite force to do so. This means that one could use such a system for deciding splits between support and object in FDM. The oil depositor would not need to be much more complicated than a felt-tip pen...

[No Title]

Monday, 18th April 2005 by Adrian Bowyer

Vik has tried an experiment with his circuit idea. He says:

"I did a quick experiment with conductive silver paint. I Stretched out commercial PVC food wrap over a box lid and daubed tracks 1.5-2mm wide on it. When the paint had cured, EVA hot-melt glue was applied to cover the tracks in an approx. 0.5mm layer.

"Spare component leads were pushed through the PVC into the EVA via the paint. A resistance of 0.6 ohms was measured across two test leads inserted into circular pads at each end of a 25mm line.

"The pen tip is not a fibre tip, but reminiscent of the old correction ink pens, and the particular one I had was prone to clogging. A syringe-based system may be more appropriate.

"I'll leave the samples for a week and see what happens to them. If all is well, I'll attempt to assemble a simple electronics kit. This should be achievable by stretching the PVC over the copper side of the board, tracing out the tracks, and pushing the components through. I might mount that one on drilled plywood though."

Here is the latest Wood's metal deposition head design from Ed Sells, all made by RP:



(To see the original look at the blog for March 23 2005.) This one has a hot-air heating jacket controlled by a thermocouple thermostat, and drive feedback from the optoswitch you can see at the top of the picture. The whole thing is straightforward to control with a PIC and the rather neat H-bridge BA6286 from Rohm. When I can get myself (and more importantly the data) organised I'll put all the designs and software up on the Documentation section of the website.

Thanks to my colleague William Megill for drawing the following measuring device to our attention; he says:

"It's basically two thin copper wire coils set in a sleeve of silicone rubber. As it's stretched, the coils get further apart, which changes the capacitance. Strains up to 150-200% are no problem."

See this link for details.

[No Title]

Monday, 25th April 2005 by Adrian Bowyer

With reference to Vik's glue gun idea: I have found out that you can get ABS cylindrical rods for plastic welding (e.g. [here](#)). ABS melts around 110 deg C, which means that it should go in a glue gun no problem (especially if you run the gun from a light-dimmer to allow you to adjust the temp). ABS is the plastic of choice for commercial FDM machines. Now all we have to do is to find some of the right diameter...

[No Title]

Friday, 29th April 2005 by Adrian Bowyer

Hoeken has found more possible CAD input. He writes:

"Just found another 3d CAD project: gCAD3D

the homepage sucks (http://www.cadcam.co.at/freiter/gCAD3D_en.htm),
however if you go to the root directory there are some screenshots:

<http://www.cadcam.co.at/freiter/gCAD3D1.jpg>

through

<http://www.cadcam.co.at/freiter/gCAD3D7.jpg>

i'm at work now so i cant really try it out. apparently it has DXF support, and can also run on windows!!"

He has also tracked down sources of bulk thermoplastics for use in the machine:

<http://www.delviesplastics.com/welding.htm>

.125" diameter abs (1lb = 160ft.) @ \$7.50/lb

gives us \$0.31 / cubic inch

<http://store.yahoo.com/ecomplastics/750diablaca1.html>

.75" diameter abs @ 3.04 / ft.

gives us \$0.57 / cubic inch.

(I can see that the people on this project are going to need to do a lot of multiplying and dividing by 25.4...)

And Vik reports that Aol has STL input/output now. Check out:

http://sourceforge.net/forum/forum.php?thread_id=1273132&forum_id=47782

John Davis e-mails to draw our attention to the following interesting paper:

Hu, Zhu; Hur, Junghoon; Lee, Kunwoo

ABBREVIATED JOURNAL TITLE- J Mater Process Technol

VOLUME 130-131

2002/Dec 20 2002

PP p 378-383

13 REFERENCE

DOCUMENT TYPE- JA Journal Article

ISSN- 0924-0136

CODEN- JMPTEF

AUTHOR AFFILIATION- School of Mech. and Aerosp. Eng. Seoul National University, Kwanakgu, Seoul 151-742, South Korea

JOURNAL NAME- Journal of Materials Processing Technology

LANGUAGE- English NDN- 267-0409-8560-3

To overcome the limitations of the layered manufacturing process, hybrid rapid-prototyping systems that allow material removal and deposition are being introduced. This approach should benefit from the advantages of conventional layered manufacturing and traditional CNC machining processes. To realize these advantages, however, an intelligent process plan must be generated. In the hybrid rapid-prototyping process, a part is decomposed into thick-layered 3D shapes, such that each layer can be machined and stacked easily. When each layer is generated from the part's shape, the build orientation is an important factor to be considered, because it greatly influences the lead-time, the machining accuracy, and the number of tool-accessible features in each setup. In this paper, an algorithm to determine the build orientation is described. It considers the deposition process attributes and the machining process attributes simultaneously. © 2002 Elsevier Science B.V. All rights reserved. 13 Refs.

DESCRIPTOR- Algorithms; Deposition; Layered manufacturing; Machine tools; Machining

IDENTIFIER- Build orientation

TREATMENT CODE- TC-T (Theoretical)

SECTIONAL CLASSIFICATION CODE- CAL723.5; CAL913.4; CAL802.3; CAL604.2; CAL603.1; CAL921

SECTION HEADING- Rapid prototyping

We had thought of a half-way-house in powder-printing machines where a powder-filled cavity in the part is vacuumed out half way through a build and filled with another material, such as Wood's metal, or silicone rubber.

Silver Paint Track Trials

Saturday, 30th April 2005 by Vik Olliver

Conductive tracks were laid on PVC film with lands at each end. Two sets of three were used; painted tracks, painted tracks with additional paint blobbed on the lands, and tracks with blobbed paint allowed to dry before additional blobs were added.

One set was dried for 12 hours, the other for 30 minutes under a fan and then both were covered in 1mm hot-melt EVA. 0.2mm tinned copper wire leads were pushed through from the PVC side and the resistance measured with a bench multimeter.

The fresher tracks were unreliable, exhibiting infinite resistance except for the plain painted track which was intermittent between 60 and 160 ohms.

The older tracks had an extremely intermittent single track, 17-50 ohm blobbed track, and 5-6 ohm for the double-blobbed track.

These results suggested that the earlier PCB experiment should be redone with double-blobbed lands and that the silver paint is allowed to cure overnight before embedding in EVA.

First Successful Silver Paint Circuit

Sunday, 1st May 2005 by Vik Olliver

The first working circuit has been constructed using techniques similar to PCB construction but with only EVA hot-melt glue and conductive silver paint as materials.

The circuit shown below (click [here](#) for a larger image) shows a working soil moisture detector; it is shown here detecting a moistened thumb. A report will appear on the <http://reprap.org> site in the near future.

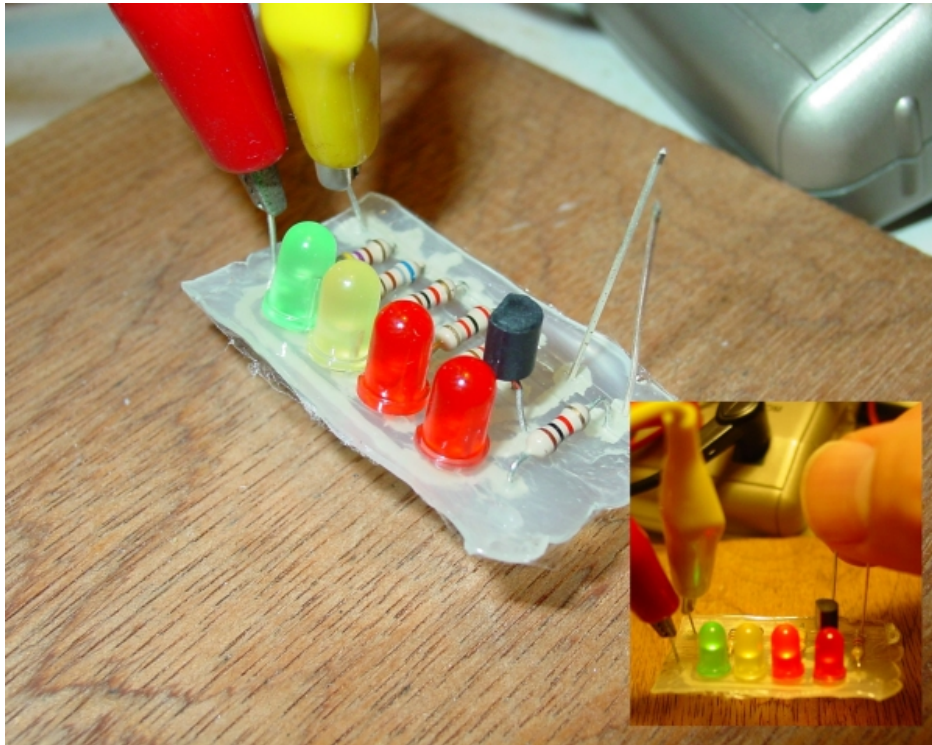

Indicator for manual intervention.

Sunday, 1st May 2005 by Vik Olliver

It might be beneficial to add a laser pointer arm to the setup so that the RepRap can point out locations that require user intervention such as component placement etc. If we use a blue LED for photosetting compounds this may suffice instead. Might also assist with alignment.

Of course, adding a camera as well that plugs into the PC would provide a 3D scanning platform.

Vik :v)

Test As You Go

Tuesday, 3rd May 2005 by Vik Olliver

By integrating test probes into the bed of the RepRap, and possibly using a wandering probe (single or multi-tip) attached to the deposition head, the assembled parts could be tested during the assembly process. Dud parts could then be either discarded or manually fixed.

PIC devices and similar could also be programmed in situ by the RepRap through these test connections rather than by first being placed in a programmer; the user need then only place the part once. A probe tip could also be used to break circuit links that are only required during the assembly process.

PIC Software Development Kits

Sunday, 8th May 2005 by Vik Olliver

I've found a GPL'd 'C' compiler and a PIC simulator that we can give away with the project.

I have successfully used the GPL'd <http://sdcc.sourceforge.net/> compiler and the GPL gpsim <http://www.dattalo.com/gnupic/gpsim.html> emulator to create and run PIC programs for a variety of target devices. Some - documented - fiddling is needed during install and I have joined the sdcc mailing list to try and eliminate this.

I'm running Linux, but the packages work on Windows too.

Vik :v)

Sucrose structures

Sunday, 8th May 2005 by Vik Olliver

Sucrose melts at 180C-190C, and so might have promise as a structural material for supporting overhangs during deposition. After construction is complete the sucrose can simply be washed away. I have a dishwasher and I'm not afraid to use it.

One could then use the RepRap to manufacture novelty confectionery, displays at weddings etc. Add a little more heat, sodium bicarbonate and a little tartaric acid for a tasty caramel honeycomb centre!

Vik :v)

[No Title]

Monday, 9th May 2005 by Adrian Bowyer

Vik's found a rather neat PIC project that does RS232 with 2 resistors and a diode. It might also make a good basis for a front control panel for the RepRap machine.

P.S. (12-V-2005): Tried the simple circuit on the Tx and Rx pins of an old 16F73 at a miserable 4800 baud. Didn't work, so back to the good old MAX232.

[No Title]

Monday, 9th May 2005 by Adrian Bowyer

Thanks again to Vik, who has now completed his report on his EVA PCB idea that uses glue-gun polymer and silver paint to make up complete circuits. This would be very amenable to RP construction. The report is available from the RepRap project's Reports, results, and documentation page.

[No Title]

Monday, 9th May 2005 by Adrian Bowyer

Many thanks to Dick Steffens, who has very kindly taken the time to review Varkon as a potential CAD system for the RepRap Project. He sent a report which I've put up on the RepRap site. Get it from the Reports, results, and documentation link. Here is his summary of the report:

In an e-mail, Adrian suggested that the two main criteria are:

1. Ease of use for precise dimensioned mechanical design, and
2. STL (or OPenRP) file output.

"With experience, Varkon probably can be precise. In the short amount of time I spent looking it over, I learned that there is a way to import and export .dxf files, but I didn't see anything about STL or OPenRP.

I (Adrian) have been looking at Art of Illusion (recommended by Vik Olliver) and at Blender (recommended by Michael van der Linden). Aoi is certainly the easier of the two to use, and seems pretty powerful. Neither is designed as a CAD system; they're for 3D graphics and animation. But both have STL output (slightly experimental in the case of Aoi) and so RepRap can use them. Now I've got the hang of them I intend to use them in anger to design the same part (a screw feed for a polymer injector for the RepRap machine), and see how I get on.

[No Title]

Wednesday, 11th May 2005 by Adrian Bowyer

Vik's chum Hayden has found a cool (stepper) motor driver chip - the SN754410 from TI. Also Bathsheba Grossman has called attention to the GNU Triangulated Surface Library in an exchange on the rp-ml mailing list. This will probably turn out to be a very useful resource for RepRap.

CAD System

Friday, 13th May 2005 by Adrian Bowyer

I have been experimenting with Blender and Aol, as mentioned previously. They seem to have about the same functionality, but Aol has a much more intuitive user interface, so I think we should go with that. In addition the Aol guys have been really helpful responding to queries and suggestions. (There is no implication here that the Blender people were not - I simply had nothing I needed to ask them.)

Note that, if the RepRap project uses Aol and you want to use RepRap, you can design with any system you like. RepRap will still be compatible with what you do as long as you can create STL files. We have no desire, nor requirement, for others to use the same CAD system as we do.

The Icing on the Cake

Saturday, 14th May 2005 by Adrian Bowyer

Icing sugar turns out to be a wonderful material for doing extrusion experiments, because:

1. You can work at room temperature,
2. You can get any viscosity you like by changing the sugar/water ratio (mix in a little glycerin too),
3. It is completely benign,
4. It holds its shape perfectly when you lay it down,
5. Fine strands set very quickly because they have a high area:volume ratio for water evaporation (especially if you hit them with a few seconds from a hair dryer...), and
6. It sets like a rock.

In addition it is a near-perfect support material for FDM, because it is water-soluble.

So I dug an old Cartesian robot out of a cupboard at the University (it was made in the 1980s...), upgraded its electronics so they were the size of a dictionary, not a suitcase, and put one of our syringe pump heads on it (the pump contains the first part out of Aol Vik mentions below). The pump has one of our heating jackets round it, but I didn't use that for these experiments - hence the unconnected angled hole at its front. Here it is (with the head enlarged top right):



I filled the pump with icing sugar and set it scribbling. It quickly became obvious that the secret is flow control (note panic button added as an afterthought to the syringe pump...). By adjusting the pump voltage, however, it was quite easy to get a good consistent track:



The good track is actually two, one laid on top of the other after the first dried. They stack well, and are about 1mm wide. This is too fat because I used too fat a hypodermic needle, but the process actually seems to work better the finer you go. However, like any good cook, **you have to avoid lumps when you mix the icing sugar - sieve it first...** To get the good track I had to anticipate the starts and ends with the panic button, making the motor run before the robot started its movement, and reversing it for a few seconds before the end to avoid blobbing. The problem is the elasticity of the syringe-pump components, which store pressure energy and cause the flow to continue after the pump motor stops.

So finally I made a crude valve on the end of the syringe by interpolating a 2cm length of silicone tube between the syringe and the needle. The result would no longer fit in the syringe pump nor on the robot, so I just pressurized the syringe permanently using a spring, and clamped the silicone tube in a pair of long-nosed pliers. This gave perfect control, and you can sign your name with the thing.

So. We may be able to replace the syringe pump with something much simpler:

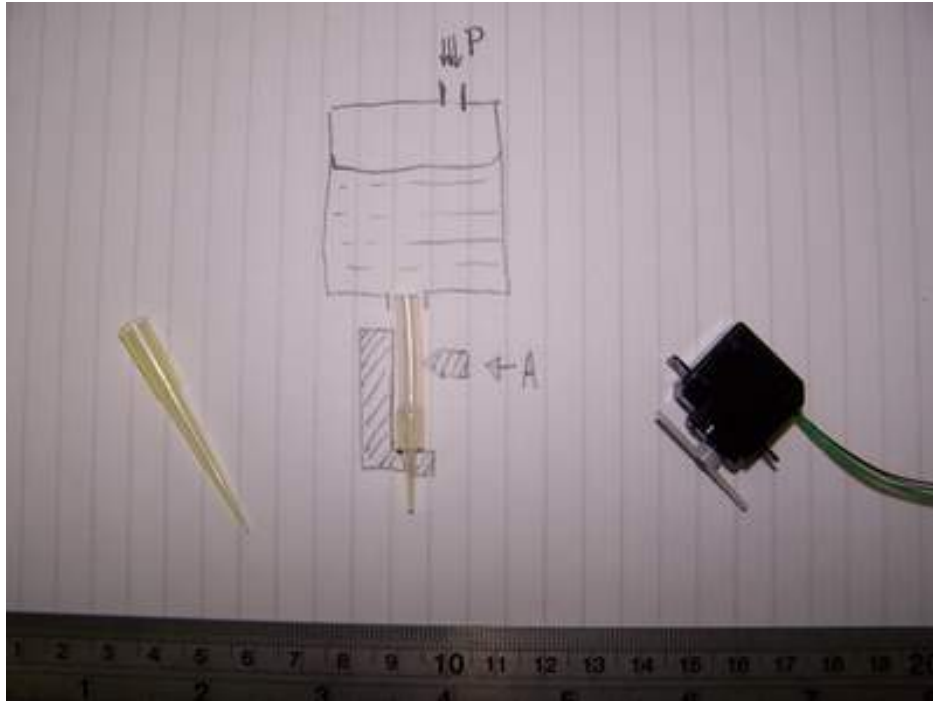

On the left is a micropipette tip. This has a hole in the end with a diameter of 0.4mm, which is about the same extrusion diameter as commercial FDM machines. It is a throw-away item costing pence, and for RepRap may represent a better bet than syringe needles as its tapering form offers less flow resistance. In the middle is the cut-off end of the tip in a silicone tube, with a diagram showing a pressurized reservoir of deposition material and a simple clamp (A). The clamp is all that is needed to make a very effective valve. This could be opened and closed with a solenoid, or maybe a radio-control servo (right).

The rule in the picture is not really bent - that's the wide angle macro setting on my camera...

A simple string-weight-and-pully experiment (below) shows that the force needed to shut off flow in the tube is 13N, though this may be a bit higher if the upstream pressure is greater than the 300mm water head that you can see in the picture, and a bit lower if the tube were to be squashed using a sharp edge instead of the flat face of a pair of pliers.



For other materials (polymorph, Wood's metal) the pipette tip can withstand temperatures of about 100 degrees C (maybe higher, that's just as far as I got), and the silicone tube is happy up there too.

First Physical Output From Aol

Saturday, 14th May 2005 by Vik Olliver

We've had a bit of a milestone in that Adrian has used the ArtOfIllusion package to output a solid object on the StrataSys FDM machine for the first time. This proves that we can now generate the STL using an Open Source toolchain. Picture is here.

I've been using stlview to examine STL output as a quick sanity check here in NZ. This viewer is cross-platform and GPL'd.

Additionally, the Aol team may be able to develop a way of creating output from their renderer in 'slices'. One neat feature of Aol is its ability to output rendering as a vector as well as a bitmap. A 'slice' of the model could be output in SVG, for example. This allows the definition of such tricky things as wall thickness and filling with crosshatch.

Some parts are being designed with 4mm holes on a 12.7mm (1/2 inch) pitch, so that they will interface easily with Meccano testbeds.

Square eyes

Sunday, 15th May 2005 by eD

Hello world (my first ever blog)

I'm the kid in the cellar trying to get a self replicating axis to work. My dissertation deadline on Friday prevents me seeing properly, so I'm not typing any more - here's a sneak preview of things to come instead...

[No Title]

Sunday, 15th May 2005 by eD

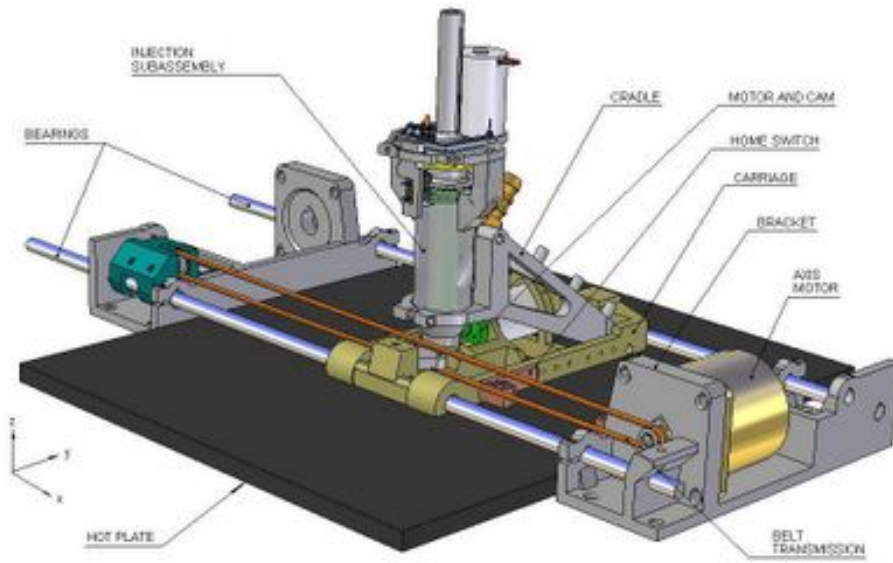

Prototype axis

PIC Software Development Kits

Wednesday, 18th May 2005 by Vik Olliver

For those using various varieties of PICs, this page is most useful for getting one up and running to build user-confidence. How to blink a light on umpteen different PICs:

http://www.voti.nl/blink/index_1.html

I have successfully used the ic-prog Windows software under the WINE Linux environment with a JDM-style "Silicon Chip 2003" PIC Programmer:

<http://www.ic-prog.com>

It was unhappy and believed the copy protect bit to be set until I turned the I/O Wait up to 17 in the hardware settings and picked "Windows API" to control the serial port. Now I can reliably program 16F628A's using hex files of my own creation that were compiled with sdcc.

[Sigh of relief]

Vik :v)

3-Axis Meccano Prototype

Friday, 20th May 2005 by Vik Olliver

By sticking the auto-descending turntable on a linear carriage, I've turned the Meccano prototype into a 3-axis machine that only uses 2 motors for positional control. I've not fitted the carriage actuator yet, but here's the prototype:



Once a layer has been deposited, the stage will rotate through 360 degrees and thus lower by 0.25 mm automatically.

This simplifies the control hardware, though the software becomes more interesting.

More than one head can be implemented along the length of the carriage, so plastic/icing tests should be possible.

My PIC prototype board can be seen against the right edge of the photo.

Vik :v)

Axis Debut

Saturday, 21st May 2005 by eD

I've made an axis (like the kind you'd find in a printer) which can deposit molten bend alloy into casting channels in a pre-manufactured component. The key thing is that the axis was desinged in-line with the self-replicating idea: most structural parts are made using RP technology, and most other parts are from the accepted parts list. There are a few exceptions to this, like linear bearings and a tooth belt, but that's OK for the first prototype.

On Friday the axis dripped its first drip! We put a test plate (with lots of straight channels in it) under the needle, fired up the stepper motor to move the carriage and started pumping the injector. The first few attempts were just about getting the co-ordination right, so don't pay too much attention to the lower channels, but if you check out the top channel you can see a 2 cm length of deposited alloy. On solidification the deposition was continuous and robust. And this was only the fourth attempt. The parameters had been a stab in the dark but the final carriage speed was approximately 5 mm/sec and injector motor had been at 10 Volts.

eD

PS> The report is on its way to the download section

[No Title]

Saturday, 21st May 2005 by eD



Injector head assembly with all systems go

[No Title]

Saturday, 21st May 2005 by eD



Injector lifted up immediately after doing a deposition run to show the testing plate which channels underneath the carriage

[No Title]

Saturday, 21st May 2005 by eD



Test piece with bend alloy deposited (by the axis) into the channels. The first runs were about getting the co-ordination right. The final run (top channel) made a continuous deposition.

Polymorph and similar materials

Thursday, 26th May 2005 by Vik Olliver

I've been dredging for information on Polymorph. Louis-Philippe Breton suggests Polymorph is a polymer known as Polycaprolactone(PCL). Unfortunately, it seems this may be biodegradable. Bad in engineering terms, and also bad for the environment. [Why? It limits the recycling and puts the carbon that was locked safely away back in circulation in the atmosphere.]

Similar materials to Polymorph appear to be:

Protoplast, sheet and pellets, various colours:

http://www.wfr-aquaplast.com/tmpgcc_default.htm

<http://www.wfr-aquaplast.com/pages/protosheets.html>

Shapelock:

<http://shapelock.com/>

Friendly Plastic by Amoco, various colours and sticks:

http://www.sunshinecrafts.com/body_friendly_plastic.html

Hexcelite / X-lite / Vara-form:

<http://www.runlite.com/varaform/index.html>

[No Title]

Thursday, 26th May 2005 by Vik Olliver

Polymorph samples have now arrived in New Zealand and have already found a use as gripping pads for the drive belt. This will be fitted directly to the Meccano trolley for the test phase. An experiment was performed to see if simple centrifuging of a syringe of hot polymorph can drive out the air bubbles. It can, but unfortunately, the resulting polyblob cannot be extruded from the syringe, even when boiled. As the syringe is also somewhat pliable at this point, it can be squeezed, separating the hot polymorph from the side of the syringe barrel and rescuing the syringe.

The FDM'd brackets arrived and are fine, except for a user malfunction that resulted in the holes being designed precisely 1mm too narrow. Expect an update to the AOI files in the near future.

Samples of magnetic rotation counters - which will be impervious to dust and other deposited crud - have been approved by Allegro, and dispatch is expected shortly. These are sensitive enough to detect individual teeth on a ferrous gearwheel rotating at 1,000+ RPM. They are designed for automotive applications, and so should ultimately be available from car spares suppliers.

Vik :v)

Extruding polymorph

Saturday, 28th May 2005 by Adrian Bowyer

Vik has succeeded in rolling accurate polymorph rods and putting them through a glue gun:



I decided to try some more extrusion experiments with it.

(Lest we all lose our sense of wonder, not - of course - at the RepRap project, but at the prodigious communication technology of the age, I'd just like to take a sentence to say how extraordinary it is to conduct experiments collaboratively with a person whom one has never met, never even talked to, and who is positioned antipodally as far away as it is possible to get and still be on the same planet; the results flash to and fro through light-fibres and a 12-hour time difference and appear instantly on a blog that is stored in a Google/blogger.com Linux box in San Francisco or Mountain View, CA; this again is about as far as it is possible to get from both of us... as Vik himself said, 'Fun this, innit?')

First I made a nozzle from an ordinary M4 screw:



I cut off all but a few mm of the thread, drilled out that thread from the back with a 1.5 mm drill almost but not quite to the top face of the head, then finished the hole with an 0.4mm drill (which is quite tricky to hold in a chuck, I can tell you...). Then I turned the head down to a shallow cone in a lathe.

Next I made an aluminium block with a 4mm hole almost all the way through, and tapped the last few mm at M4 for the nozzle.

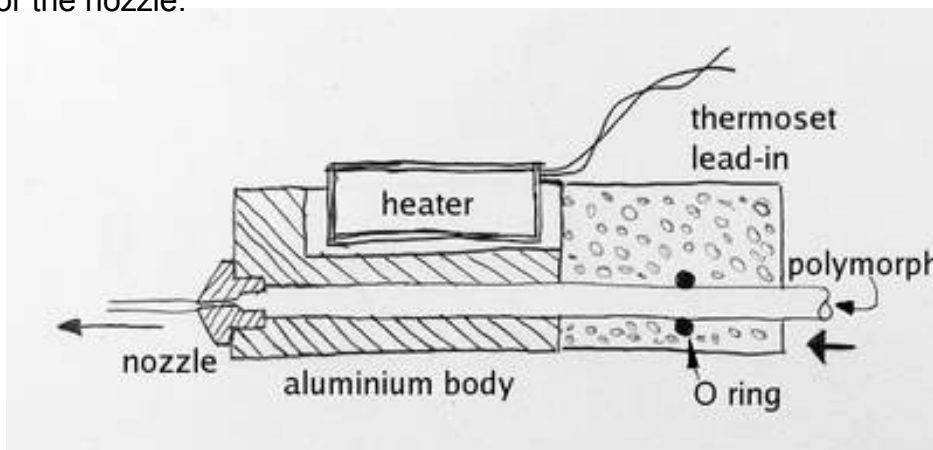

I cut a slot in the block to fit the heater out of a glue gun. I greased a 4mm plastic rod with vaseline, put a tight-fit O-ring on it, and pushed it down the 4mm hole. In an oven set at 100 degrees C I cast a block of isocyanate/polyol thermoset round this to give a lead-in for the polymorph rod where it would be kept at a low enough temperature to maintain it as a solid. Here came a piece of serendipity: isocyanate+polyol normally needs to be cast in a vacuum to outgas it in order to get a decent result. But here the bubbles it generates as it sets became a positive

advantage - they made the block weaker, but they lowered its thermal conductivity, keeping the right-end cool, even when the aluminium block was at full temperature. The isocyanate held the O-ring well, giving a good seal.

Not shown on the diagram above are 4 M3 screws. I drilled and tapped the aluminium block M3 where it would join to the thermoset and put four screws in with their heads protruding about 4 mm. These were to give a strong key for the thermoset to hold it onto the block.

Before I did all this I boiled up a scrap lump of isocyanate in cooking oil - it was stable and happy up to at least 180 degrees C. Here is the finished extrusion head together with a rolled length of polymorph. The hole bottom right is for a thermometer.

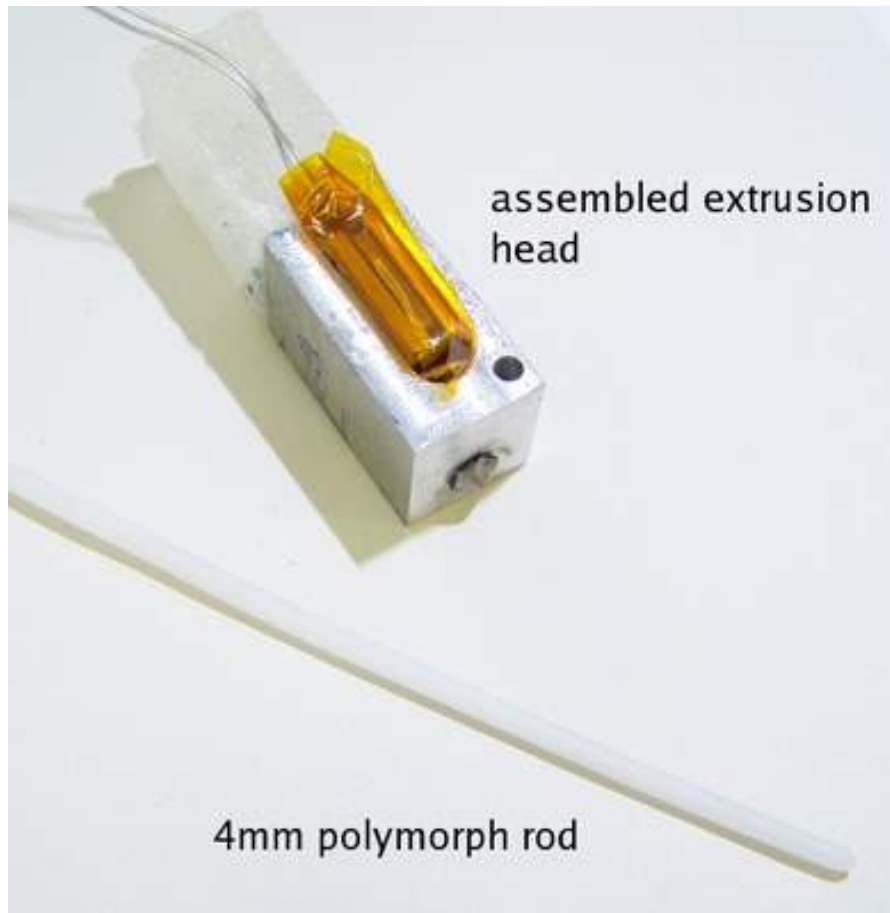

(Incidentally, glue gun heaters are really simple - they consist of a ceramic resistor sandwiched between two aluminium plates with a small spring plate to make the whole thing push-fit. The result is wrapped in a high-temperature polymer sheet for electrical insulation. The mains is connected across the aluminium plates. The resistor is about 800 ohms at 20 degrees, but this rises with temperature, giving an amount of negative feedback.)

As Vik found, the 4mm polymorph rods are very easy to make. You just put a lump of the stuff in boiling water to soften it, take it out, and roll it between two flat rigid plates using a 4mm diameter rod to get the thickness. You might imagine that you would get the best results with two such rods, one either side of the rolling polymorph, but it actually works better with just one. This gives a

slightly undersized rod, as the plates are at a slight angle to each other. But the physics of the situation makes the polymorph roll immediately adjacent to the rod, so the reduction in diameter is very small. And, if you stop rolling before the polymorph fully sets it springs back a small amount, compensating for its reduced diameter.

I used polymorph granules from Maplin, but Vik also found a company (see below) making a similar material already in rod form: WFR / Aquaplast.

Finally I put the whole thing together, plugged in the heater, and pushed the polymorph rod through by hand. I would guess that I was using a force of about 70N.

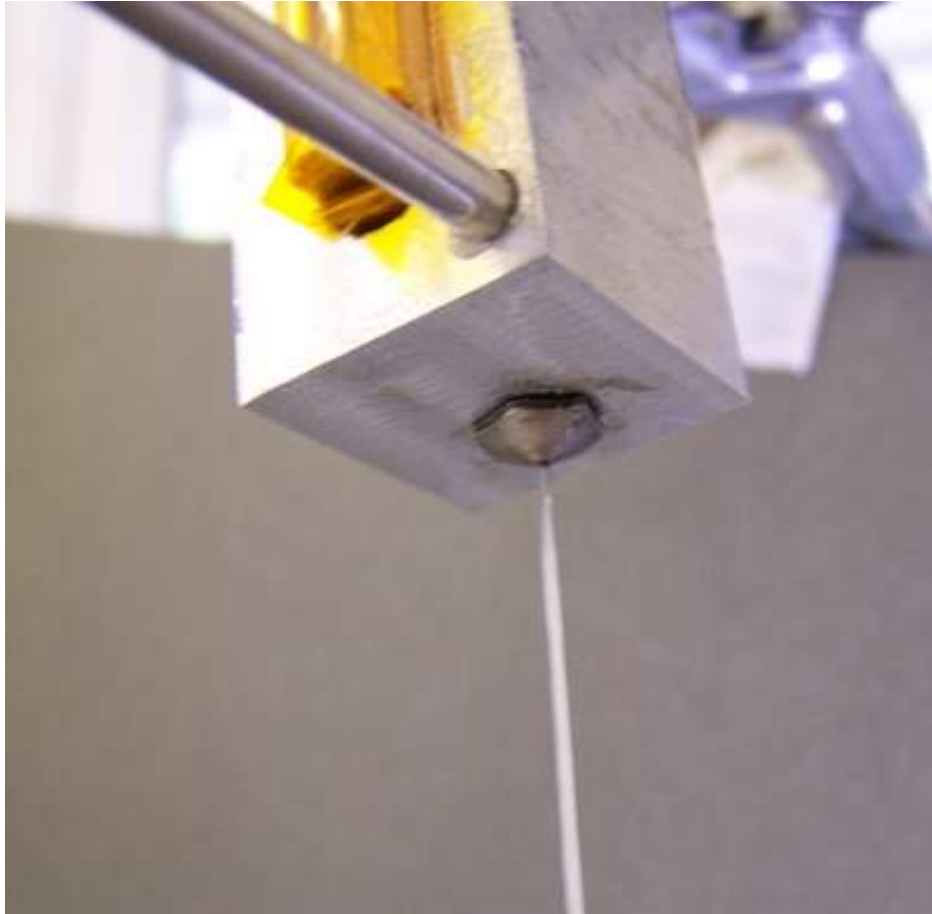

The material extrudes well at around 120 to 130 degrees C. Note the change in colour as it sets. The final diameter was 0.5mm, indicating a small amount of die-swell, as would be expected.

Postscript to polymorph extrusion

Sunday, 29th May 2005 by Adrian Bowyer

On a whim, I put an M4 die in my lathe chuck, set the lathe on its slowest speed, and fed in one of the 4mm polymorph rods I made for the extrusion experiments described below. I held the free end with a pair of pliers to stop it from rotating. The result was an M4 thread right down the rod:



I put a nut on it and used that to push a tube with an i.d. of 4mm against a set of scales. It held to over 100N (then I had to stop pushing...). This gives an interesting way to feed the material into an extruder: thread it, then wind a nut against a stop to force it into a heating chamber. Here's a crude sketch:

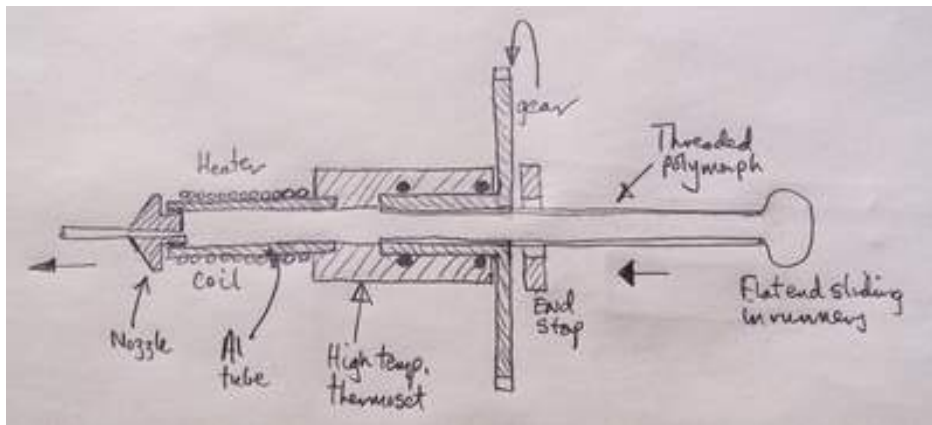

On these matters, Steve DeGroof e-mails to say: "Not sure if this would work but have you considered using airbrush nozzles? They typically come in 0.6mm, 0.4mm and 0.2mm sizes. You usually have to order the nozzle, needle and cap as a set but they should still be fairly inexpensive." This seems a neat idea to save people having to machine nozzles.

Polymorph moulding

Sunday, 29th May 2005 by Vik Olliver

Using some Wood's metal, I made a mould of the end gear on an HP printer motor; it's a toothed gear that engages directly with the drive belt. It took some effort to separate the mould from the original gear, and despite warming everything up with a hairdryer first, a large air bubble formed inside. You can see where some Polymorph got trapped in it in this photo:



Undaunted, I drilled out the hole left by the shaft to suit Meccano shafts, and tapped a shaft gently home with a large mallet. If I had been thinking, I would have sprayed a little oil in at this point, and anchored the shaft in the vertical position.

Hot Polymorph was pressed firmly into the hole around the shaft, and a 2-hole Meccano collar pushed in on top. One of the holes embedded itself nicely in the Polymorph, and the other stuck out allowing me to attach the collar to the shaft with a grub screw. For a permanent fit, Adrian suggests putting a flat on the shaft.

Getting it out was a mission, as the Polymorph had invaded the cavity well. Consequently, the gear was slightly distorted after extraction, and mildly eccentric. This was fixed up with a hot knife, and re-centred after warming the shaft with a hair dryer.

The gear is now in use in the Meccano trolley prototype and will do until I can get a replacement FDM'd up. As it is on a collar with attachment grubscrew, I have been able to change my mind over the length of the shaft it is mounted on a couple of times. Emulating this in an FDM'd model will be fun!

Vik :v)

Turntable Scanner

Sunday, 29th May 2005 by Vik Olliver

I thought I'd better document an idea that I saw in O'Reily's "Make" blog while looking at postings about RepRap - I'm unable to find the original link. The concept was to use a rotating turntable and a moving laser pointer in conjunction with a video camera and some clever software to scan in and digitise an object.

Well, the Meccano turntable would both rotate and lower the object simultaneously so a static laser pointer could be used. As the method was already proved, it would appear that RepRap + laser pointer + video camera = 3D scanner.

Unfortunately I'm a bit busy making the fabricating side of things, but if anyone wishes to make a turntable-based scanner do let me know how you get on!

Vik :v)

Finned extruder

Tuesday, 31st May 2005 by Vik Olliver

As you can see in the photo below, I've looked at the possibility of using fins to keep the entrance end of the Polymorph extruder cool. I got the idea off a gas-powered soldering iron pictured on the right. The 12mm aluminium cylinder has fins carved half-way through. These were made by rotating the cylinder in a power drill and hacking away with a large hacksaw.



Heating the cylinder up to 180C with a soldering iron resulted in a 10C temperature drop across the fins. Further experiments will use more fins, wider gaps between them, and some form of variable power supply for the soldering iron. We'll need at least 60C of temperature drop across the fins in order to reach the extrusion temperature of 120C Adrian was using without prematurely melting the incoming Polymorph.

The new AS5040 magnetic sensor samples from Austriamicrosystems arrived today, and let me say that these people really know how to provide sample kits. They even provided a small, battery-powered demonstration board with the samples and a little magnet. Vielen dank, guys!

Vik :v)

Yet another polymorph extruder

Saturday, 4th June 2005 by Adrian Bowyer

Encouraged by my previous polymorph extrusion experiments, I designed a much simpler extruder. Though I used a lathe to make a part of it, with care it ought to be possible to build this design using just hand tools as the only operations were drilling holes and tapping threads (which I did by hand anyway).

I started with a brass M6 countersunk screw:

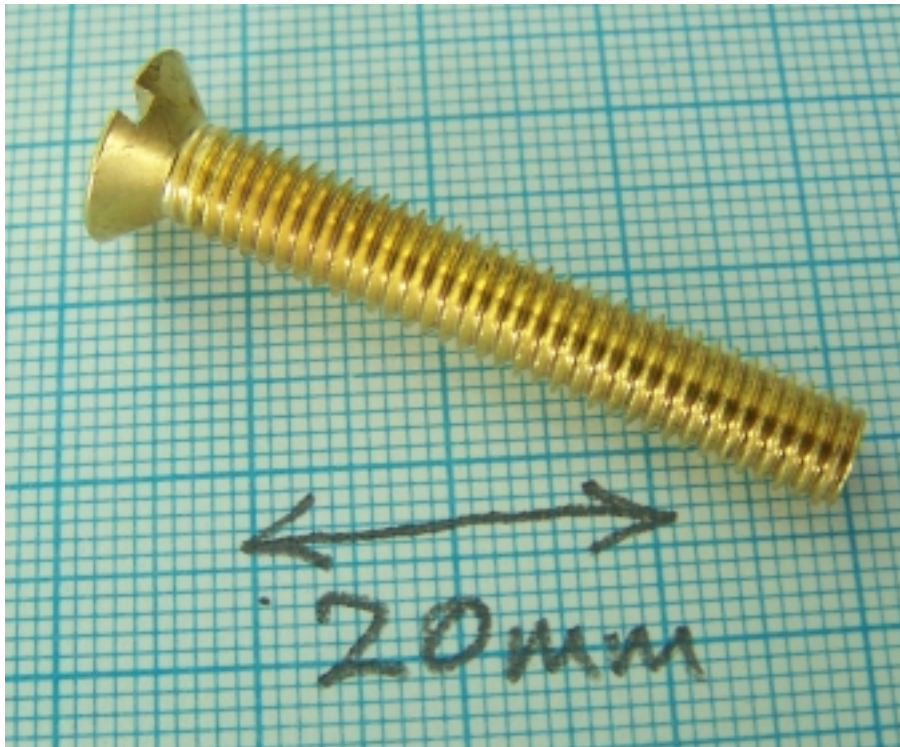

I cut the head off, and drilled a 3mm hole right down the middle:

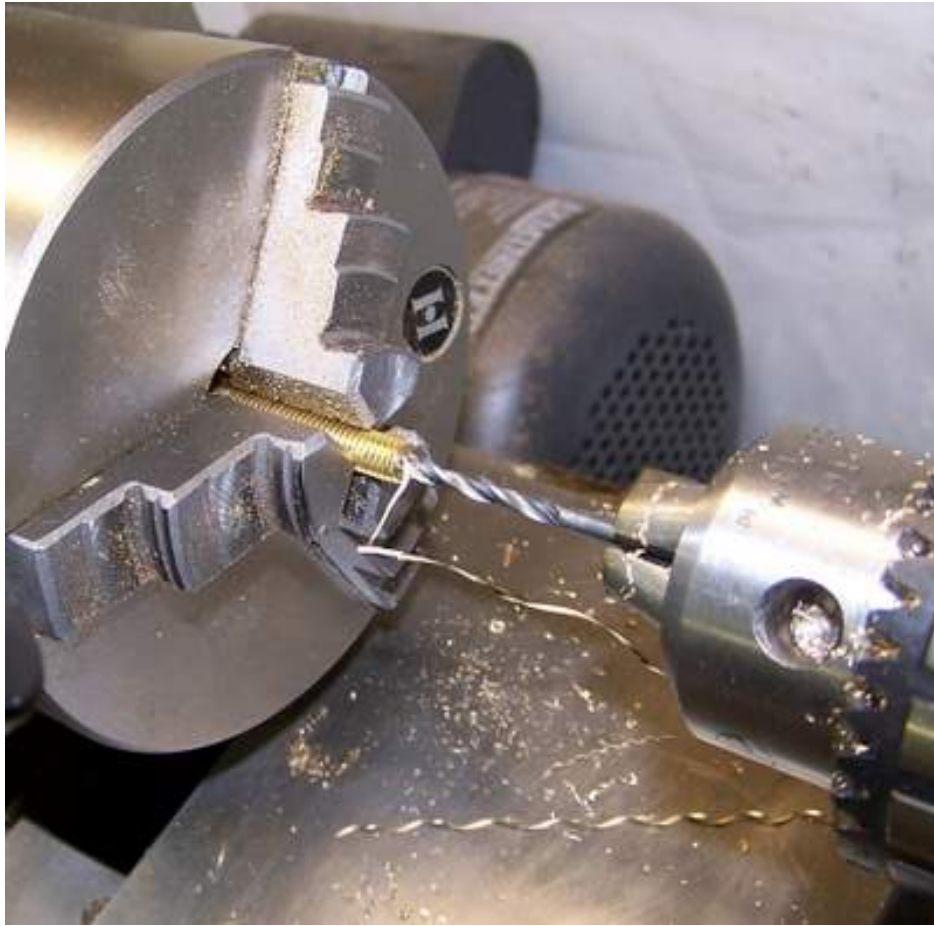

One could instead use M6 brass studing, or one could cut a thread on the end of a piece of brass tube (only the last 5mm or so actually needs to be threaded, as will become apparent, though the rest of the thread is useful to guide the heater wire, as will also become apparent). I drilled out the end, tapped it M4, and fitted the nozzle described in the blog for 28 May (*q.v.*).

Then I wrapped some PTFE thread-sealing tape (obtainable from all good plumbers' suppliers...) round the thread...



...and wound a 300 mm length of 0.2mm diameter nichrome wire into the PTFE-insulated valleys of the thread as a heater. The PTFE needs to be thin to allow heat conduction, but thick to prevent shorting with the brass. About two or three thicknesses seemed to work well. I then put a thermistor ([RS 484-0149](#); cut and paste that part number into the box top-left on the RS main page) against the thread at the nozzle end and wound more PTFE tape round it to keep it warm.

I drilled a 3mm hole down a 40mm length of 10mm diameter PTFE rod, then drilled out and tapped M6 the last 5mm or so:



I then screwed the whole assembly together:

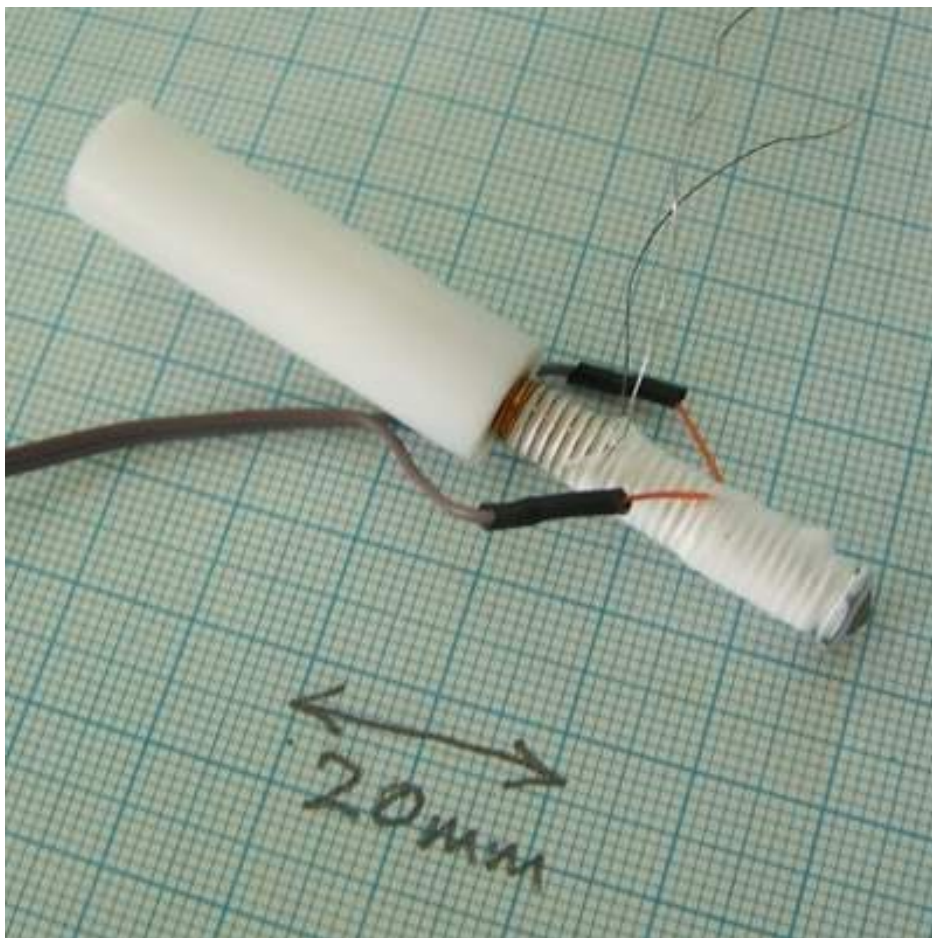

The thermistor is the bump at the right hand end; this was positioned past the end of the heater windings to get temperature readings from the brass, not the nichrome heater wire; before putting the thermistor on I cleared a patch of PTFE away using a wall file to expose the brass, so the thermistor is resting right on the metal; I wrapped a little PTFE tape round the thermistor leads to stop them shorting. The heater wires are the ones heading off top right.

I rolled up some 3mm diameter polymorph rod, and switched the heating current on. 300 mm of 0.2mm nichrome wire has a resistance of about 12 ohms, and I was running it at 12 volts (i.e. 1 amp / 12 watts). This brought it up to temperature (about 130 degrees C, or a thermistor resistance of about 350 ohms) so quickly (less than a minute) that I had to turn the voltage down to prevent overheating. This is good, as it means it should be easy to do PWM temperature control with a PIC and a power transistor.



(Note the extremely rusty retort stand; this was done on a Saturday morning in my lab at home, not the well-equipped ones at Bath University...)

The multimeter on the left is measuring the thermistor's resistance, and the bench P.S. on the right is supplying the heater.

I pushed the polymorph rod through. A force of between 20 and 30N gave extrusion at 2mm per second.



The PTFE rod stayed nice and cool, and should be easy to clamp into the pinch-wheel feed that Vik is designing. It may be necessary to put a hot-air heating jacket round the extruder, not to keep it hot, but to direct hot air down to soften the polymer that has already been deposited to get good adhesion.

Extruder feed mechanism image

Monday, 6th June 2005 by Vik Olliver

Adrian is currently printing the first draft of the pinch wheel feed mechanism for the extrusion head. It consists of two interlocking pinch wheels that push the 3mm Polymorph rod down a guide and into the opening in the 10mm PTFE rod:

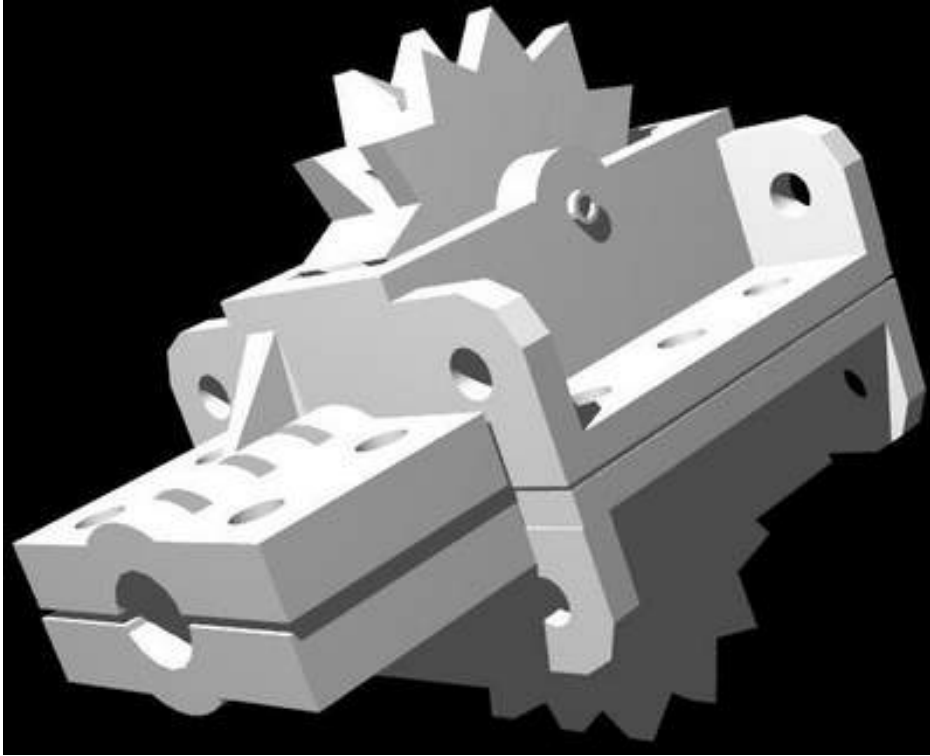

Small holes in the pinch wheels can take metal points if additional traction is required, and the symmetrical clamp should hold the PTFE rod centred.

The strange lumps near the axles of the pinch wheel are where ArtOfIllusion seems to fall over when trying to poke a hole using its boolean operator. It was much faster to add drill centring points and drill manually than fix the obscure bug! I did actually try to fix the bug, but no joy. Still, onwards and upwards we go.

Nozzle made of solder

Wednesday, 8th June 2005 by Vik Olliver

I had a successful run on the 'Afghan Lathe', and managed to bore a beautiful 3mm hole in an M6 bolt, right down the middle. To avoid the use of fine drills for the nozzle, I tried out an idea we'd had on using solder. I propped a piece of 0.32mm nichrome wire vertically in the hollow brass bolt - I'd only drilled the last 2mm out to a 1mm hole on that end - and soldered around it. When the solder was cold, I pulled it out with pliers to leave a 0.32mm hole in the solder. Nichrome is very handy here as it can't be wetted by standard solder.



Tests with a syringe show it squirts water in a straight, true jet. If it works with Polymorph, it'll be a very simple way of making nozzles of varying sizes. This first one will be incorporated in a Polymorph extrusion nozzle similar to the one Adrian just made, and we'll see how well it ejects Polymorph.

Metallic glass

Friday, 10th June 2005 by Adrian Bowyer

This could be useful: an amorphous (i.e. non-crystalline) metal alloy with a glass transition temperature of only 68 C. It was developed by Wei Hua Wang of the Institute of Physics in Beijing. [See here for details.](#)

Carriages from Polymorph

Saturday, 11th June 2005 by Vik Olliver

My friend Keith was round, kindly offering to make up a wooden base for the new prototype here in New Zealand. It was during the process of explaining what we wanted it for that I tried to demonstrate a carriage mechanism, and walloped a saddle together out of Polymorph that sat around a ground steel bar. It worked beautifully. The low friction and close fit formed the perfect saddle on the carriage guide bar.

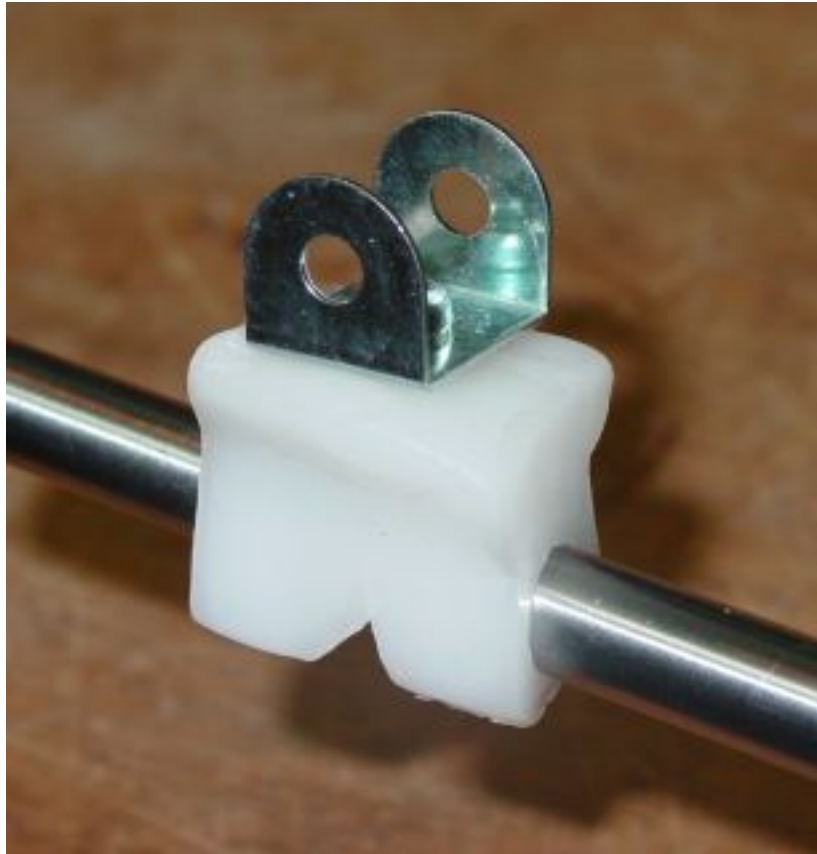

The trick was to slit the underside of the encircling Polymorph so that it would slide freely on the bar. Chopping out a bit of the centre section further reduced friction. As you can see from the photos, we also melted a Meccano bolt into it, and can remove it to attach various fittings. The insertion was best done by warming and pushing the bolt in with a soldering iron.

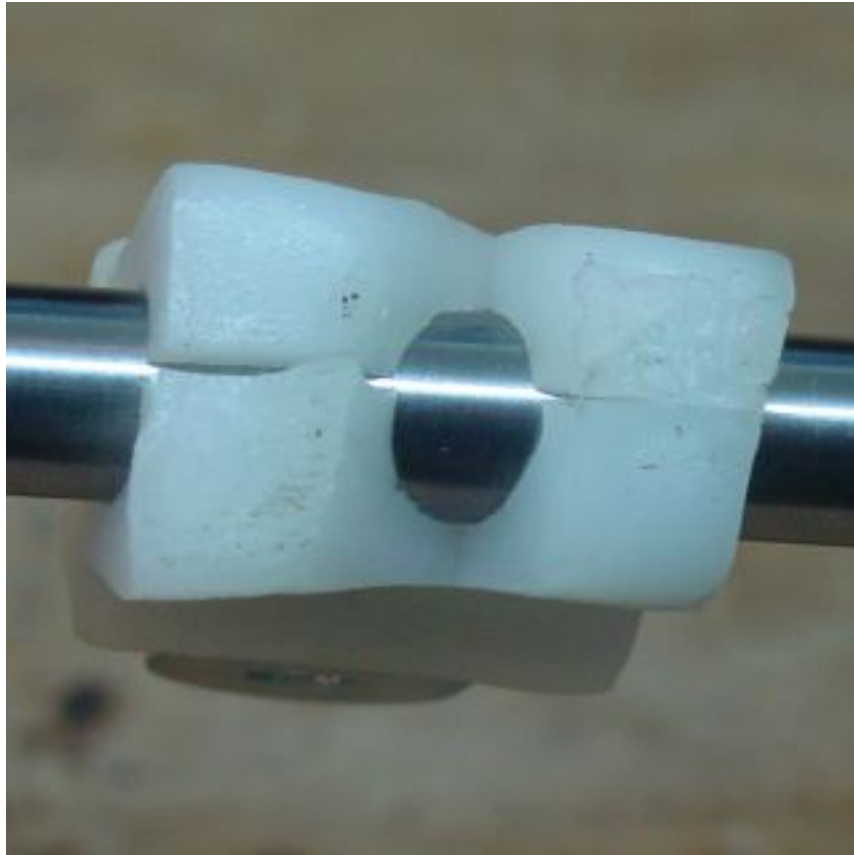

This method has the added advantage that, as long as the carriage bars are parallel, it does not really matter what size they are. Polymorph supplies permitting, we'll try to build an entire carriage mechanism based on Polymorph and Meccano - which we can replace with manufactured components as we progress.

We've also produced a detachable 0.32mm solder nozzle made from a couple of bits of M6 bolt and an M6 nut. The nozzle part is soldered to the M6 nut, and PTFE tape ensures a leak-free join onto the main bolt. We did use mostly lead-free solder here (melting point 220C), but it would not tin the brass and we had to resort to 60/40 solder to do that.

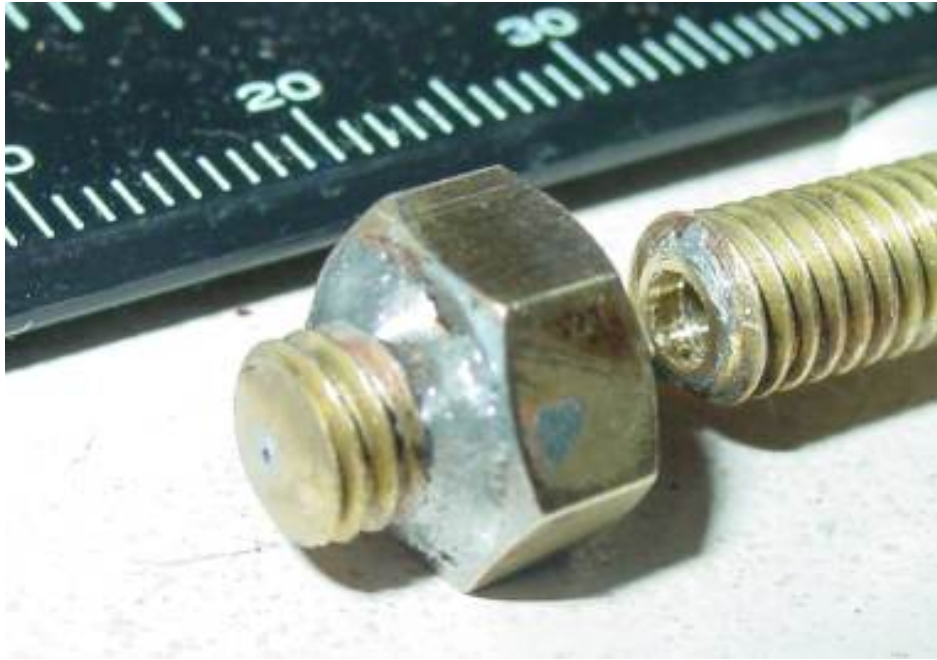

Vik :v)

Feeder head for polymorph extrusion

Sunday, 12th June 2005 by Adrian Bowyer

I've done a different design to Vik's for a feeder head to go with the polymorph extruder in the blog of Saturday 4 June. Mine's more complicated than his, but is a bit stronger. Here's a close-up of it working:



It consists of two pinch wheels driving a 3mm diameter polymorph rod into the top of the PTFE tube (see the previous blog). The pinch wheels are 40mm M4 cap screws being turned by gears at the back. The knurling on the cap screws gives a good grip on the polymorph, though it still slips a bit, so this is not the final design. However, if you want to download the STL file for it (1.6MB), [click with the right mouse button here](#). Here's a close up of the feed mechanism:

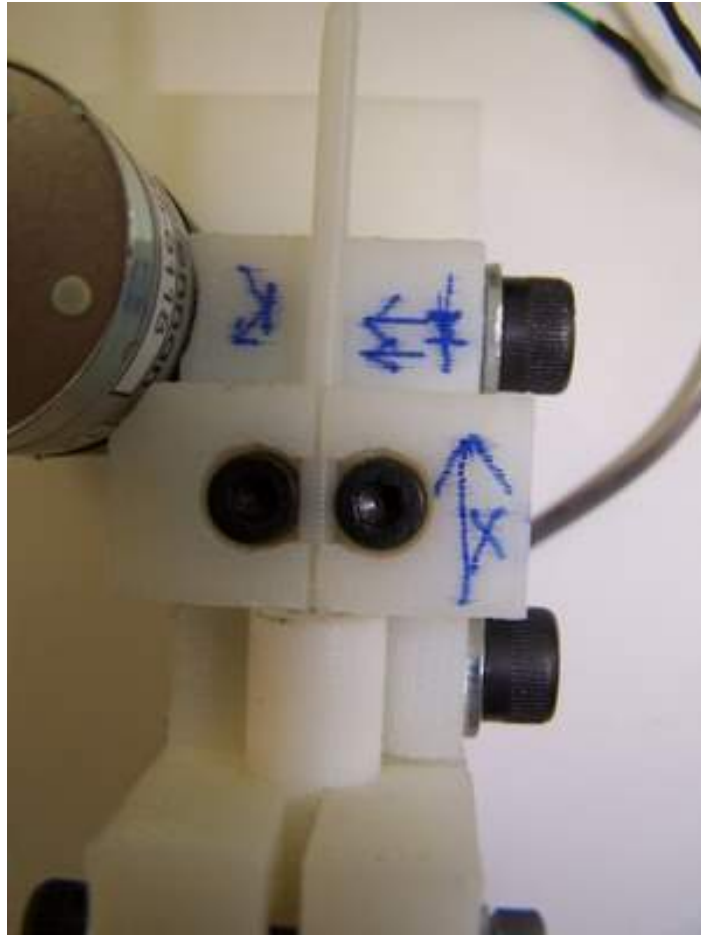

The cap screws run in bushes embedded in the head. The two M6 screws that you can see the heads of on the right serve to clamp the pinch-wheels together, and the one half out of the bottom of the picture clamps the PTFE tube of the extruder. Ignore the blue scribble - that's just me making notes to myself...

Here is a view of the gearing at the back:

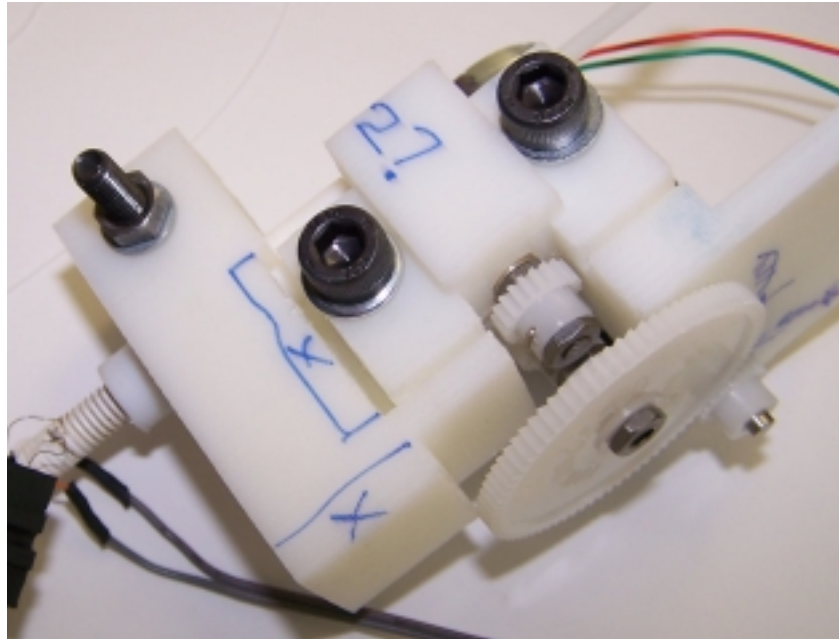

Just to the left and above the small gear you can see the shiny end of the bush insert.

The whole device works quite well, but needs a few improvements. These are:

1. Double or triple up the pinch wheels in a totem-pole up the polymorph rod to reduce slippage; they're only cap screws with gears on the back, so that's not going to cost much more.
2. Use Vik's much better solder nozzle design (see the blog for 8 June; improved further by his making it detachable on 11 June). If one used the higher temperature solder that would allow the polymorph to be worked at a higher temperature. One could also bury a loop of one end of the heater nichrome wire in it and use the brass extruder barrel to make one of the heater connections. This would automatically make a thermal fuse to prevent temperature getting to the point where PTFE starts to decompose (250 C). The problem Vik found with the solder not wetting the brass may resolve with additional flux. More experiments needed...
3. Switch to steel or brass gears. The nylon ones are plenty strong enough, but I had to drill and pin them to the shafts. It would be much simpler to file flats on the shafts and to attach the gears with grub screws. This'd need metal gears to hold the grub screws strongly enough.
4. Fit two optical sensors, one to measure pinch-wheel speed, and one to detect when the polymorph rod runs out so the machine can go fetch another.
5. Control the whole thing (including the extruder temperature) with a local PIC, rather than by hand...

Here's the parts list:

1. The RP part from the STL file,
2. 1 off: 40mm M4 cap screws with 20mm unthreaded shaft at the top,
3. 1 off: 30mm M4 cap screws with 20mm unthreaded shaft at the top (or saw 10mm off Part 2 above...),

4. 5 off: thin (2mm) M4 nuts,
 5. 2 off: 25mm M6 cap screws,
 6. 1 off: 30mm M6 cap screw,
 7. 4 off: M6 nuts,
 8. 4 off: M6 washers,
 9. 1 off: 35mm M6 brass screw,
 10. 2 off: 5mm M3 countersunk screws (for attaching the motor),

 11. 45mm x10mm diameter PTFE rod,
 12. 400mm 0.2mm diameter nichrome wire,
 13. A reel of PTFE plumber's tape,
- Plus these parts from RS Components :
1. 1 off geared 12v motor - 245-6118,
 2. 1 off 80-tooth gear - 745-270 (this needs an internal diameter of 4mm, which it doesn't have so you'll need a sleeve to make it fit),

 3. 3 off 20-tooth gear - 286-2355,
 4. 1 off thermistor - 484-0149,
 5. 4 off bushes - 262-1939 (two in each hole).

Idea for future circuit production

Monday, 13th June 2005 by Vik Olliver

For the far future of the RepRap, we might be able to make our own microcircuitry in a way that borrows principles from the current silicon manufacturing technologies.

If we have a photosensitive organic semiconductor ink that hardens on exposure to light, and project the image of a circuit (possibly using a PC screen or some other emissive display) onto a substrate coated in it, then the conductive polymer is fixed in place. Wash it and put a layer of another ink on, expose that to a different set of tracks, rinse and repeat until the circuit is complete.

RepRap should enable the production of equipment that can automate this process. Like I say, far future, but we have to get these ideas down in case some antisocial tries to patent them...

Vik :v)

Bolt-based Polymorph Pusher MkII Proposal

Tuesday, 14th June 2005 by Vik Olliver

Having seen Adrians wondrous system using the pinch bolts - and incidentally having just got hold of my pinch-wheel design out of the Stratasys - I've had another bit of activity in the brain cell. Why not use the bolt thread?

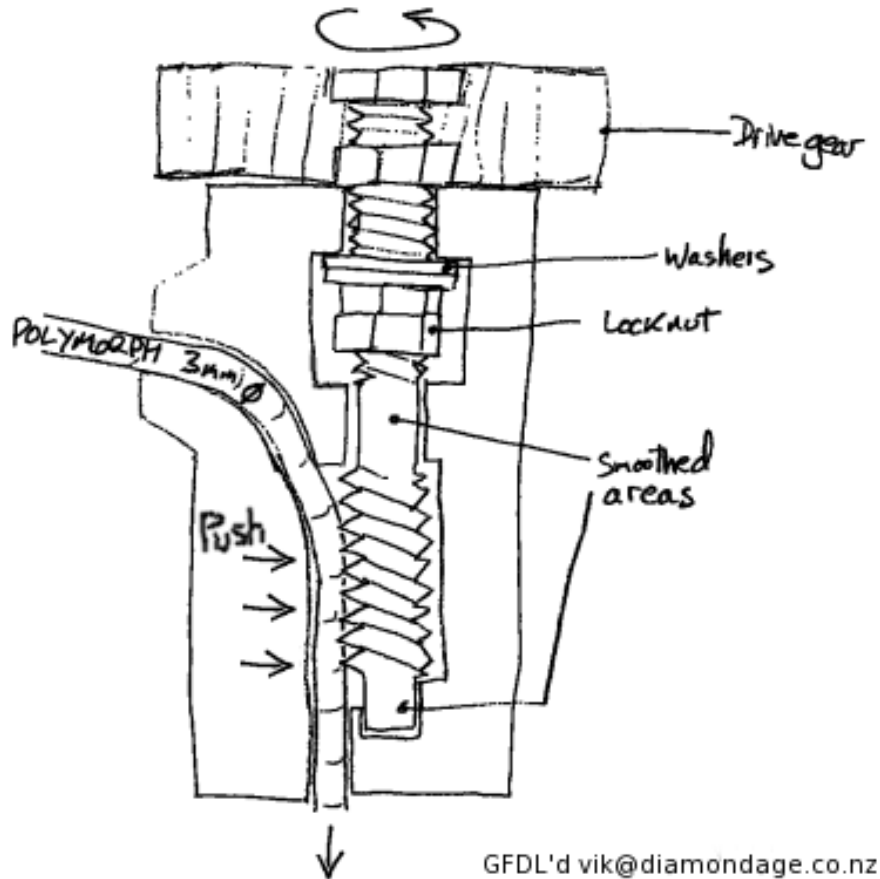

GFDL'd vik@diamondage.co.nz

Trap a Polymorph rod next to a bolt in an enclosed space, turn the bolt and keep it steady - Polymorph moves along the thread. There's an inherent high gearing and ratchet from using the thread, but we might need to put a bit of spring-loading (easily FDM'd) in there to hold the Polymorph firmly against it and make up for any imperfections in the feedstock.

Also, the bolt can then hold a drive gearwheel, keyed onto a nut (or two if you want to be really sure, and want to locknut it without compressing the gear). The stress on the gear wheel might be low enough to enable the use of extruded plastic gears.

No prototype photos yet - I only had the idea this morning. Funding permitting (Suz is still very budget-conscious) I might get a cheap electric screwdriver on the weekend and see if it can drive the thread directly.

Vik :v)

Polymorph Carriage Tests

Wednesday, 15th June 2005 by Vik Olliver

The first tests have been done on the Polymorph carriage, oiled lightly, with the feet trimmed to 75% of the circumference and de-stressed with a hair dryer. Smoothly overcoming the friction between the four saddles requires a force of 2.6N and 1.2N keeps it moving:



The carriage itself weighs 140g and I started to wonder just how much power we're going to want to expend on moving the carriage around at this point?

As an example, the tiny little 3V-6V Meccano motor I have here consumes 200mA startup current at 3V and will move the carriage. Assuming that's around 50% efficient, thanks to the gearbox, and a load on the carriage that is expected to be about 300g, the diligent student should be able to work out the maximum speed and acceleration. It's been a good few years since I did physics at school...

Would anyone like to tell me:

- The likely top speed.
- What's the acceleration, and
- Is this good enough?

Vik :v)

PS Spot the cameo appearance of the FDM'd pinch wheel assembly.

Polymorph Carriage and Clips

Saturday, 18th June 2005 by Vik Olliver

Ash and myself have assembled our first rod-based slide, using the Polymorph saddles described earlier. I've also made a set of unsplit Polymorph clamps to hold the rails, held in place with Meccano screws (dunno what they are, but they're close to M4). We'll see if they need grub screws later - they're easy to melt in with a soldering iron and tweezers. Meccano came to the party and donated a Centenial Crane Kit to the cause; though it had no gears in it there were plenty of long Meccano bolts and little pulleys.

A two-part Polymorph clamp is used to hold the drive belt to the carriage without damaging it, and the clamp is attached to one of the first FDM brackets Adrian made for me. The 150g assembly can be seen here, dragging an additional 800g:



With an additional 900g payload, the drive belt starts to slip occasionally. So we can set our rough estimate for the maximum mass of the carriage assembly as 1050g. I'll whack off 250g for errors and safety margins for the moment, and figure on a total carriage mass of 800g.

This carriage, when fitted with a turntable, looks like weighing about 750g. This only leaves 50g for the payload - our extruded artifact. But Meccano is a lot heavier than Polymorph, so we'll see how we go with the gradual replacement of parts. Besides, 50g of Polymorph actually goes quite a long way.

The switch on the side of the carriage is for later trials. We're going to see if we can get it shooting back and forth at maximum speed, and then we'll see if anything warms up or falls off.

Vik :v) & 4sh

Turntable Proposal Mk I

Wednesday, 22nd June 2005 by Vik Olliver

Based on the shortcomings of the Meccano turntable, I've drawn this proposal for an auto-lowering turntable. It relies on using 3 vertical pieces of M5 studding driven equally by a gear train. Play in the gear train should not be significant for the purposes of raising or lowering, but the fit of the initial worm drive onto the turntable shaft will need to be a good one.

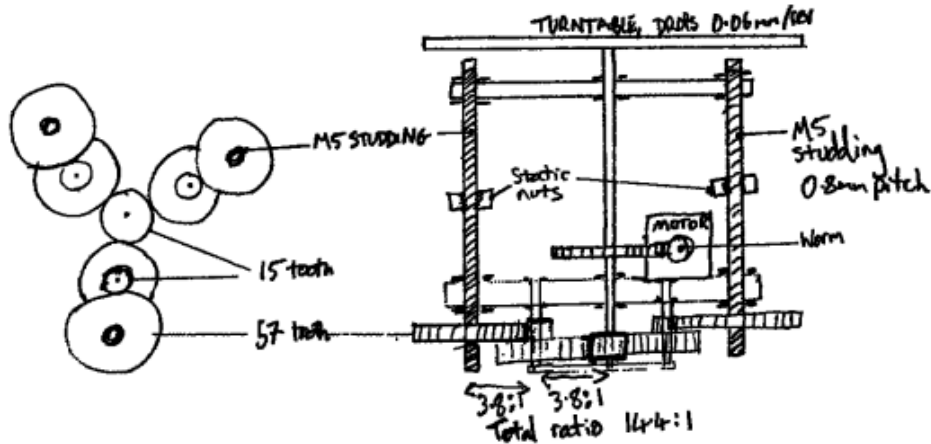

As the centre of the turntable rotates, the M5 studding rotates at 14.4:1. As the thread pitch is 0.8mm, every revolution causes it to drop relative to the static nuts approx 0.06mm. So it can rotate back and forth through one revolution to do the fabrication, then rotate twice to drop 0.12mm and build the next layer.

Not sure what to do for bearings yet. I might smooth things off, or I might pack the studding into cheap skate bearings.

I learned a lot about gearing designing this, but feel free to enlighten me further :) Worst case, we might have to use separate motors but this would be simpler.

Vik :v)

Possible new polymer

Wednesday, 22nd June 2005 by Adrian Bowyer

If RepRap could use the aliphatic polyester polylactic acid (PLA) as its primary working polymer that would be good. The advantages would be that it:

1. Has a low melting point (150 C; glass transition: 60 C),
2. Is mechanically pretty strong [yield: 70 MPa (nylon: 80 MPa); modulus: 3.2 GPa (nylon: 3 GPa)],
3. Is biodegradable, and
4. Can be made from biomass.

Actually, as Vik and I have pointed out before, having a polymer that is biodegradable is a disadvantage, as it means that products made from it don't lock up atmospheric carbon (but all these recycling directives that insist on it are written by politicians, so what do you expect?). But if the polymer comes from biomass, then at least the whole process is carbon-neutral.

In the case of PLA, the polymer can be made by the fermentation of corn (maize), a crop that will grow in poor soils in a very wide range of climatic conditions. This allows the possibility of having the RepRap machine make its own fermenter, and then having a manufacturing process for high-technology goods that could be bootstrapped straight from an agrarian base with very little capital expenditure. Rich World look out: here come the African farmers :-)

A good source of information on PLA is Rafael A. Auras's Powerpoint file available [here](#).

A colleague of mine at Bath is working on the stuff too, and has promised me a sample. So experiments on it will be blogged in the near future...

P.S. - an excellent paper on polylactic acid production by Narayanan et al. can be found [here](#).

I2C And RS232 Code for PICs Under SDCC

Thursday, 23rd June 2005 by Vik Olliver

This page as a useful discussion on making RS232 and I2C interfaces work under the SDCC compiler on the PIC. Some of this will no doubt be useful to us:

<http://hawthorn.csse.monash.edu.au/~njh/electronics/pic-tricks>

Vik :v)

Video Of Polymorph Saddles

Thursday, 23rd June 2005 by Vik Olliver

Robert at Webtec has kindly hosted the video of the Polymorph saddles being stress-tested. The videos are identical, but are spread around to balance the load (it's a 620K MPEG):

-
[link1](#)

-
[link2](#)

-
[link3](#)

In this video the saddles where the carriage contacts the rails, the brackets holding the rails down, and the attachment point for the belt drive to the carriage are all made from Polymorph and are held in place only by physical fit and bolts threaded directly into the Polymorph.

The recoil visible is not caused by the carriage slamming into the end of the rails, but by the motor rapidly reversing as the carriage lines up with the vertical bars.

I left this going for a couple of minutes, and nothing warmed up or fell off. It won't be going this fast in the final thing, and a sturdy frame is under construction by Keith.

Vik :v)

Strength of objects made by layered manufacturing

Saturday, 25th June 2005 by Adrian Bowyer

This may not be an original idea, but I haven't been able to find a reference to it.

Objects made by RP are anisotropic. In particular they tend to be stronger in the layer directions (say X and Y) than in the Z direction. This is particularly true for the extruded filament technique that we use. But it should be simple to program an RP machine to leave many small blind Z-axis holes in solids and then to inject-fill them using the write head when they reach the top of the solid. This should increase strength significantly, and also not slow the process down (the time taken to fill the holes should be less than that saved by not making them solid in the first place).

Just a thought.

Head mounts & sizes

Tuesday, 28th June 2005 by Vik Olliver

Keith, Ash and myself have mated the 3D axis assembly with the frame and dangled an extruder over it for the first time, to size up the gantry that we'll need to hold the extrusion mechanism:

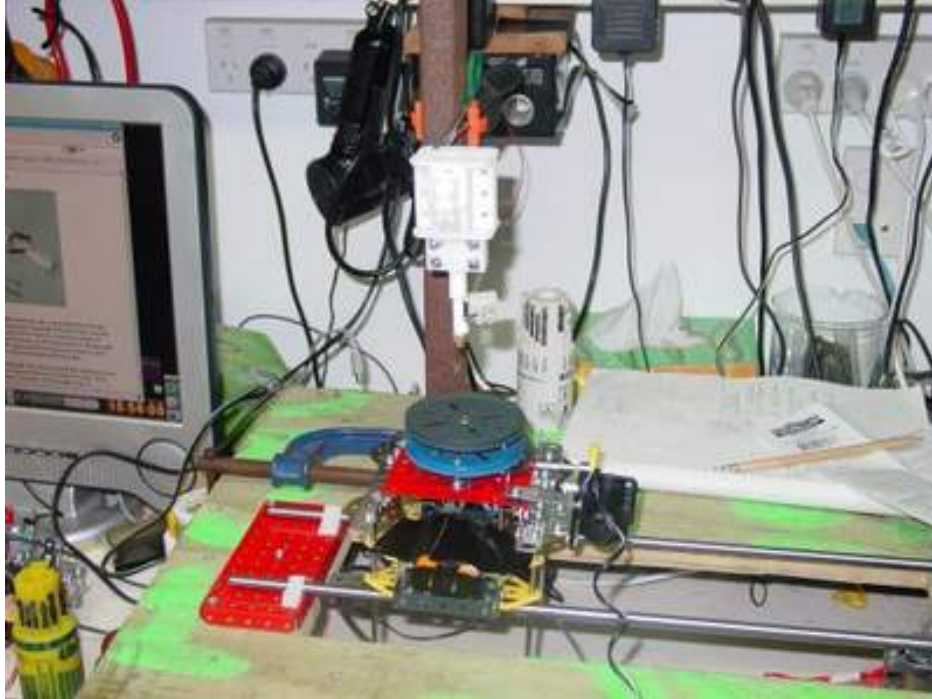

After some discussion we thought we might try mounting two parallel rails over the top of the linear axis, and allow the head units to suspend themselves there. By fitting the head assemblies with adjustable feet, we'll be able to reposition each head individually to align with the centre of the turntable at the appropriate height.

In short, this proposal will allow multiple heads to be integrated at an early stage, and define a method of implementing interchangeable heads that can be exchanged with other users.

I informally suggest a gap for the rail spacing of 100mm with enough error to accommodate people who like to think in terms of 4 inches :)

What do others suggest?

The photo shows my freshly-made example of Adrian's extruder clamped by the now obsolete pinch wheel assembly. It is at least serving as a space model!

Ideas From The Dumpster

Thursday, 30th June 2005 by Vik Olliver

While searching for some useful gears and motors inside a bugged CD drive, I noticed a few things of note to RepRap. First off, they're using a rack & pinion to move the head on rails that look pretty similar to what we've got, just smaller. The rack and it's driving motor are anti-backlashed as you can see from this photo:

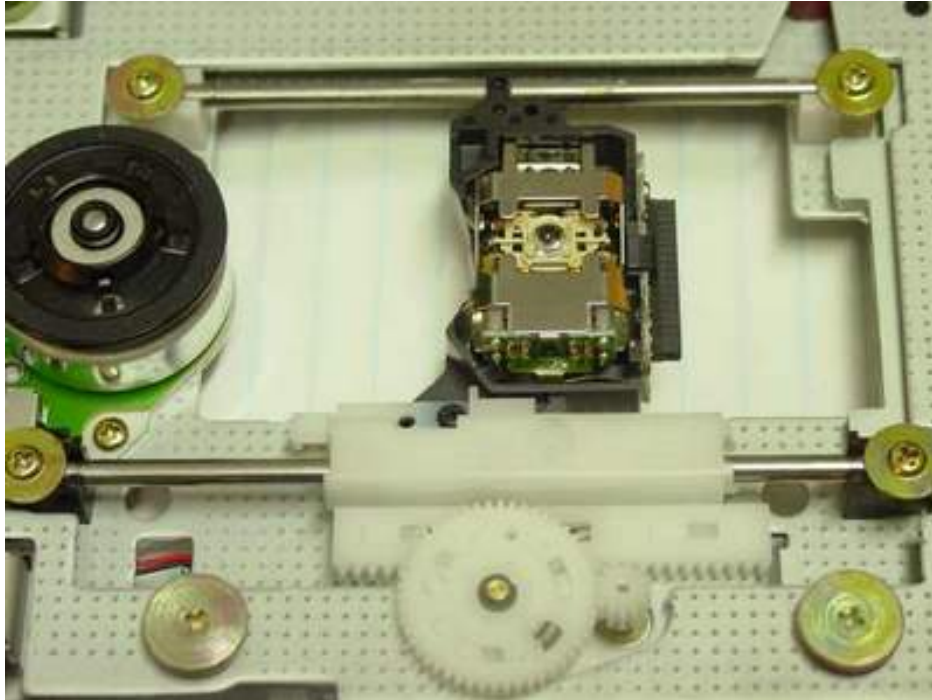

The anti-backlash is the springy thing inside the big gear, for those going "huh?" The gear wheel is split, and the two halves propelled in opposite directions. This pinches the gear on the neighbouring shaft, and cuts out any slackness in the movement. A similar trick is done with the rack.

They've also only used the inner quarter contact surface of their rails, which we might try to reduce friction further.

Gantry Welded Over Meccano Prototype

Saturday, 2nd July 2005 by Vik Olliver

Well, the freshly-constructed gantry has appeared. Not finished - and it won't be until we know exactly where to weld the bracing. Paint fumes while welding are not healthy. As it is, my nose feels half full of welding slag



We'll line it up properly tomorrow with the bolts, then Keith will give the wooden parts a sand down and lick of paint.

This should now let us dangle Polymorph and icing extruders over a moving turntable. It is likely that, following some messy extrusion experiments, attention will then focus on what to make the turntable out of and how to level it.

Vik :v)

Going All Curly

Sunday, 10th July 2005 by Vik Olliver

We've got the new chassis fully assembled, and we've run off a few unsatisfactory attempts at cylinders. Some fine tuning is required to match the flow rate and rotation rate. We've got a built-in CPU fan to cool the workpiece instead of the ruddy great standing fan used previously.

I think we might be able to build LM7805-based 12V/5V power converters on screw terminal strip, so keeping hot stuff away from potential Polymorph components.

The new frame needs some decent power - for the fan as well as the motors - and signal cabling put in. We've taken to using curly replacement phone handset leads for my signal wires. 4 cores, readily obtainable and easy to stretch around the place. Cheapskates can run up non-curly versions or use the spare ones that come with modems :)

One problem is a decent source of RJ11 sockets. Fortunately a mate discovered a cache of RJ11 female-female adapters, which can be broken in half to provide 2 RJ11 socket. This saved some old phones and blown modems from dissection for the cause.

For power connectors we're just using aforementioned screw terminal strip at the moment. Cheap car lighter extension leads look useful; again they come in curls, have a built-in 5A fuse, ample extra cable for scavenging, and will make plugging the RepRap into a car really easy for use on holiday! I'll grab one next payday.

Vik :v)

The "Afghan Lathe" technique - Updated

Sunday, 10th July 2005 by Vik Olliver

I've finally documented the "Afghan Lathe" technique for using an electric drill to lathe and centre-drill. This makes the construction of Adrian's nozzles and various other components possible with common power tools.

This revision is less than half the size of the previous one to download, and contains Adrian's instructions on winding a heater element around the freshly-turned brass bolt.

The second draft is here (446K download) and comments are welcome:

http://diamondage.co.nz/research_docs/Afghan_Lathe.pdf

190 People downloaded the first draft. Nice to see they felt no need to comment :)

Seriously though, if anyone does want to improve the document, contact me for the source.

Vik :v)

Afghan Lathe as a web page

Monday, 11th July 2005 by Vik Olliver

Adrian is kindly hosting the "Afghan Lathe" document as a web page so you can pop over for a quick browse. This is the version that shows how to use a power drill as a lathe, and construct a heated RepRap nozzle with interchangeable nozzle ends:

http://reprap.org/Downloads/Afghan_lathe/Afghan_Lathe.html

Vik :v)

Inverted wire-wrapping

Wednesday, 13th July 2005 by Vik Olliver

Driven by the scarcity of low melting-point alloys and the wide availability of wire, I wondered if it might not be a good idea to design a wire-wrapping head that deposits fine copper or phosphor-bronze wire.

Wire could be hitched around protuberances on the plastic object under construction, and spiralled against the walls of holes in such a way as to hold components that are pushed into them. The use of wire has been previously mentioned, but it is not necessary to coat the wire before depositing it. The wires can be insulated and fixed securely in place by overwriting with plastic - or even icing!

It might be necessary to heat the holes slightly to ensure the wire sticks to the walls. It might even be practical to make IC holders for SMT components by strategically laying the wire in lines, and arranging a clamp to hold the IC on top of them.

Wires can be joined by spiralling them into the holes, or around protuberances. In fact, it might be practical to forget holes and develop notched pillars that are wrapped with wire as a kind of socket. These would accept components pushed into the notches after the wire has been wrapped around them:

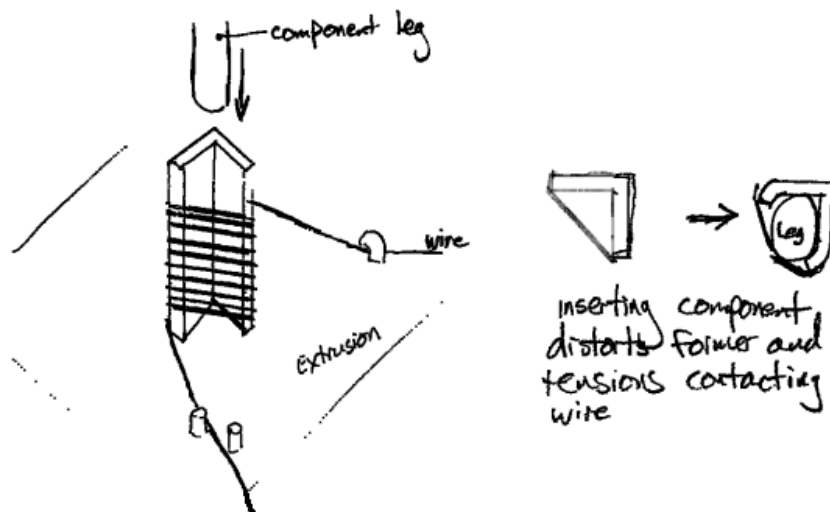

Where wires cross, the lower wire is first buried in deposited plastic.

No time to test right now, so pipe up if your interests are inclined in that direction - i.e. if you are a secret sewing machine collector or somesuch.

Vik :v)

Closeup of Turntable

Friday, 15th July 2005 by Vik Olliver

Here's a shot of the levelling mechanism and gearing used on the latest Meccano turntable. By adjusting the long bolts under the turntable we can ensure the turntable remains level while it rotates, and adjustment of the long bolts on the large blue pulley allows us to ensure the axis rotates vertically.



Once we've modified the Polymorph saddles, we'll probably add a cam mechanism to move the carriage as the turntable rotates. This should allow the deposition of shapes other than round bits of tube, without having to develop the electronics and software first. Hopefully we'll have some of the mechanical principles debugged and ready for the other bits.

Vik :v)

Meccano prototype with new turntable

Friday, 15th July 2005 by Vik Olliver

We've got quite far with the Meccano prototype. This is what it looks like now (some samples shown on block in right-hand corner):



Note we've added a 5V power supply, hence the large heatsink. The turntable now has three adjustable legs, and is made of an old sweet tin lid, rather than being a Meccano gear wheel. The toy pistol lower right has turned out to be a good source of strong springs.

We have added the changeover switch from a cars' electric window mechanism. This allowed us to make the carriage and turntable assembly fly wildly back and forth. We have discovered that when the extended turntable comes to a sudden halt, the Polymorph saddles spontaneously detach ("fall off") from the rails, and the whole blooming thing jams!

We will attempt to fix this by mounting the saddles with their supports held vertically. This may also reduce friction further.

We've just realised that our LM7805 power regulator - the one hiding behind the heatsink at the front - is rated at 1A. Our motor takes about 1.5A, so we're rapidly looking into this LM350K variable voltage regulator-inna-can-thingie I found. These beasts apparently happily supply 4.5A to hungry motors, but need a little more setting up.

Vik :v) & 4sh

Polylactic Acid

Friday, 15th July 2005 by Vik Olliver

We recieved a sample of polylactic acid in the mail today. Some preliminary tests with a bowl of boiling water and a hair dryer on max setting were conducted. Results are as follows: It doesn't melt.

Using a k-type thermocouple probe, we checked the temperature put out by the hairdryer at 120C (approx.) At this point a few grains started to turn transparent and welded to one another.

As we have no way of making polylactic acid rod, we can't quite feed it through our extrusion nozzle. Yet. Time to bake polylactic acid cookies...

Vik :v) & 4sh

Flat structures from EVA

Thursday, 21st July 2005 by Vik Olliver

While these glue gun "blobs" aren't too impressive to look at, they illustrate that we can successfully bond layers of EVA:



Keith and I got the final one going this morning, using the winding pulley mechanism shown below. It's not a puddle - it is actually cohesively constructed in a spiral manner. The counterweight is on the end of the white string exiting to the left:

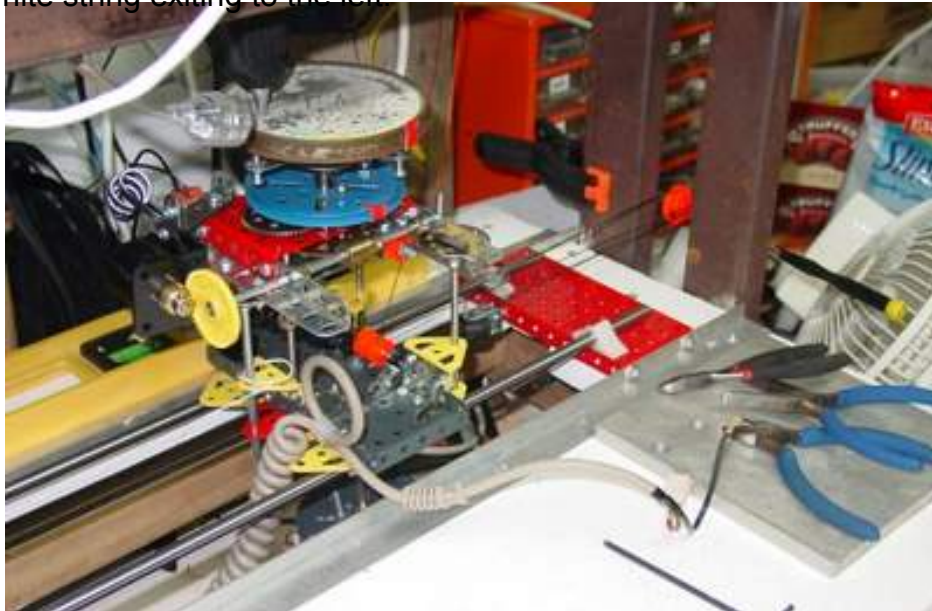

Bear in mind that we are lowering the table manually, and not compensating for the increase in the relative speed of the turntable as the head moves further from the centre. In all, I think we did well !

We've also produced a glue gun Polymorph nozzle that extruded 0.8mm strands of same. Unfortunately it is not practical to use a standard glue gun mechanism or the systems I currently have here to push Polymorph through at any useful rate. We're experimenting with wider nozzles, and we'll widen it until we get one that works.

We've also put a proper power switch on the RepRap, so I don't leave it powered on at night - the cats might spark it up.

Vik :v)

Quick fixupses 'r' us

Friday, 22nd July 2005 by Vik Olliver

The Polymorph saddles no longer leap off the rails of the Meccano prototype - we've cast a 270g lead counterweight and slung it underneath to stop the toppling on sudden stops. Future versions will be balanced more carefully.

Also, our 5V 1A power supply is stable with the larger heatsink and the motors take 0.4A peak (0.15A continuous) each so there is no need to upgrade. This is great, as we're planning to switch to 12V motors eventually and don't want to be burdened with unnecessary work.

I've made a little aluminium block with an 8mm hole through the middle that is handy for joining EVA glue sticks. Melt ends of glue sticks, push and one stick into each end of the hole. Peel off the excess and with great strength haul the block off when cold. Nice, smooth join - should work with 3mm Polymorph rod too.

What else? I've gone off phone lead connectors - too fiddly and too unreliable. So I've chopped the plugs off and used terminal strip. Much better.

This weekend is dedicated to family life, but I expect to work on a version of the turntable that is moved by a cam next week. Real, 3D shapes coming soon...

Vik :v)

It is an ex-glue gun. It has ceased to be.

Monday, 25th July 2005 by Vik Olliver

We're picking up subtle hints that our "\$2 Shop" glue guns may not be suitable for prolonged use. This, our second victim, is an ex-gluegun. It has ceased to be:



It is not pining for the fjords, and it wouldn't go vroom if you put ... hang on, it did go >FOOOOM!< at 220V. No lab personnel were injured in the explosion, though nearby an unrelated syringe was shot dead by armed police.

Vik :v)

PLA thermal characteristics

Saturday, 30th July 2005 by Simon McAuliffe

After receiving some sample PLA from Vik, I thought I'd just see how this stuff behaves at our extruder temperatures.

It turns out it melts at a much higher temperature than I expected. I expected it would melt between 130°C and 180°C. Here's what I found:

155°C starts to become noticeably glassy, but granules are still quite hard.

170°C starts to deform

180°C granules merge together very slowly (still too viscous to flow in any useful way)

185°C slowly flattens to a single continuous mixture, but still very viscous. Quite meldable at this stage though.

200°C still quite viscous

230°C still quite viscous. I'm not sure it will extrude easily at <1mm thicknesses.

I didn't test further than this because the current extrusion system won't be very happy at any higher temperatures.

This suggests the PLA is an extremely high MW sample. In all likelihood if we can produce our own PLA it will have a lower melting point. In fact we might have the reverse problem where we can't get it high enough.

Steppin' in, steppin' out...

Monday, 1st August 2005 by Vik Olliver

I've made a few changes to the Meccano prototype, now known locally as "Da Witch" (due to the recycled front panel from a Da[ta S]witch) as you can see from this illustration:



This picture shows a sturdy steel brace laid across the rails. If you look carefully, you'll see a protrusion from the brace resting on a small white cylinder under the turntable - this is the cam.

Tests show that a more controlled approach is needed to rotating the turntable and controlling the feed, so I've had to learn about stepper motors.

On the front left corner, you can see a fitted breadboard area that comes wired in to the prototype's power supplies. Next to that is the stripped chassis of an old 5 1/4" floppy drive, with just the stepper motor left on it. The motor is a 6-lead centre-tapped motor with 2 tapped coils running at 12V. This is handy because it allows the motor to be stepped in both directions without having to reverse current flow.

The lowest component count I've managed for the driver is 2 chips - a PIC and an ULN2003 darlington driver. Both are very common and low cost parts, and no other bits are needed; the LEDs are just for my own personal confidence building exercises :)

Vik :v)

Floppy stepper update - updated :)

Tuesday, 2nd August 2005 by Vik Olliver

Our floppy stepper motor does seem to have enough power to shift the turntable at realistic speeds. Keith, Ash and myself set one up last Tuesday night after hacking it and its bearings out of a floppy chassis with a cutting wheel. Earlier tests were not so good, and we now suspect a mechanical problem with the prototype causing bearings to bind.

We put a worm gear on it and put that in the place of the worm on the turntable assembly. It initially moved in both directions, but very slowly and with only just enough power - it got stuck on a few occasions, even when not driving the screw shaft. Stripping down the turntable and rebuilding some bits of it resolved the problem.

The resolution seems a bit lacking, but we can live with it. The motors have an 18 degree step, and with a 100mm diameter turntable that needs to move at roughly 0.1 degree steps to get 0.1mm accuracy. At the moment we've got that but there is no room for error, and anti-backlash gearing will be needed.

My PIC programmer now refuses to erase PICs under Linux, despite having all the right volts on the pins. Moving it to Suzzy's Windows box allows it to work 50% of the time so I suspect timing issues.

Still, we can drive steppers in both directions at varying speeds with the ULN2003 and we've now got a proper USB-serial connection mounted up on the front panel with terminals leading to the breadboard area. Next step is to mount up a MAX202 chip and get some serial connectivity going.

Vik :v)

Screw thread drive preliminary experiment

Monday, 8th August 2005 by Vik Olliver

I've recovered enough from a bout of the 'flu to write a few things up. Having got control of some small stepper motors, we thought we'd try out a screw thread drive instead of belt drive. So Ash and I coupled a section of M5 studding to a stepper motor using some 2mm and 4mm PVC hydroponics tubing. For bearings we used the capstain bearings from old 5 1/4" floppy drives, and trapped them in Meccano holes as shown below:



By using small slivers of plastic tube, we were able to securely grip the M5 studding in the bearings with nuts without fouling the bearing itself.

The motor is not strong enough to drag the Polymorph sliders, so we've built a small wheeled cart while we come up with something better. A pair of angled long-nose pliers held shut with rubber bands grips an M5 nut on the studding, and pushes the cart back and forth:

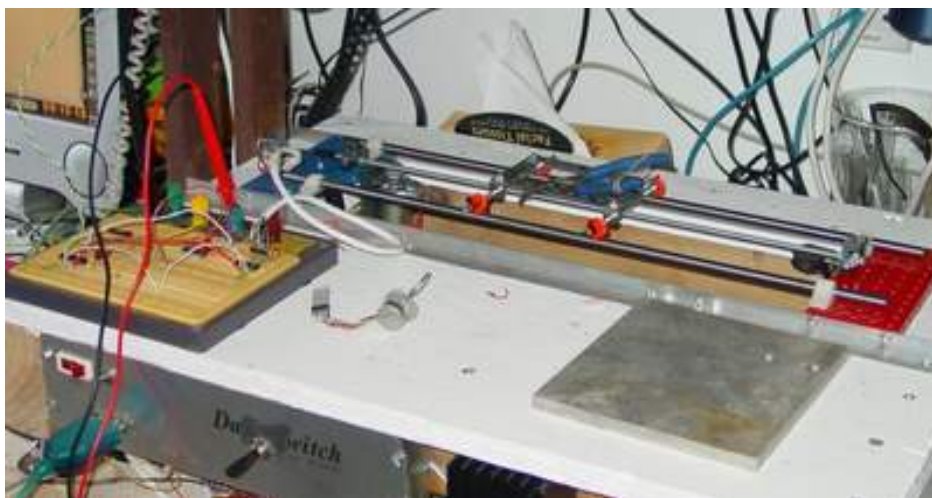

We've been testing the Allegro UDN2559B buffer/driver part with good results on our stepper motors (the ULN2003 is in "last orders please" mode). It can sink up to 700mA, which we have discovered is enough to blow the output port on a PIC. It also survives being short-circuited and

springs back into life when it cools down. Only 4 ports per chip, but as with the ULN2003 no other parts are required.

We've got rid of the old DC motor on the turntable now, and will be using steppers in the future except possibly for the extruder. We're considering using a separate stepper for vertical motion control as the drivers we're using make for very simple circuitry. It also cuts out the long wait between printing an artifact and waiting for the turntable to crank itself back up again in preparation for the next test.

A shortage of plain old 0.1uF capacitors and the 'flu delayed plans to get the MAX202 serial interface chip connected up. When I'm out and about we'll see if we can't control things through the USB/serial interface (blue plug in the bottom left of the control panel).

Powder-based RP technology

Friday, 12th August 2005 by Adrian Bowyer

This is probably not a new idea, but I haven't been able to find it anywhere, so I'm putting it up here.

All the powder-fusing/gluing RP machines that I have seen (Z-Corp, SLS etc) build in a powder that is held above a piston in a tube. This is all very well, but can be mechanically complicated. It also means you have to fill the entire volume to whatever depth you want no matter how small the part you're building is.

Why not have the RP machine make its own tube as it goes? Just have a descending platform and a mechanism to wipe powder flat over (part of) the width of it. Then build your part and at the same time build a dam round it to contain the powder. Excess powder would fall at the sides for recycling. The dam may have to have a slight draft angle, getting smaller as it gets higher, for this to work.

You get the big advantage of being able to build small objects without laying out a full volume of powder.

The Two-Step

Sunday, 14th August 2005 by Vik Olliver

The RepRap Meccano prototype turntable is now mounted back on the rails, using small pulley wheels rather than Polymorph sliders. A sensor magnet has been added to the turntable together with a reed switch on the carriage (blue & white wire), and a limit switch to the right-hand end of the rails (green and white wire):

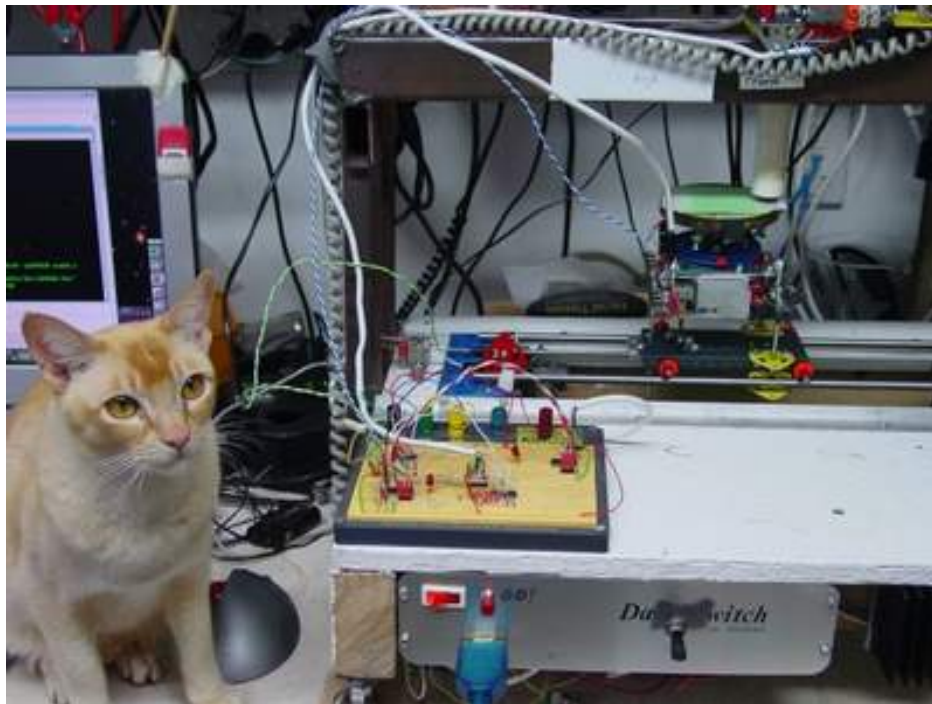

A "GO!" switch (red & black wire, also front panel) has been added to allow visitors to initiate actions while I'm showing off. Actually, it's a little more useful than that; I've added a sync sequence to locate the limit switch and reposition the carriage in the centre of the rails at the same location each time the power is applied. I'll then be able to conduct a manual arming sequence for the extrusion head and start it going when I'm good and ready.

This also has the convenient side effect of moving the carriage to the far left whenever the power is cycled. Handy for getting it out from under the deposition head to clean the turntable or extract an artifact.

The white tube dangling from the extruder only contains a fat marker pen. It does not contain mice, despite the opinion of my furry feline companion Chad. The marker is used to show that the track followed is consistent, at least in 2 dimensions. Adding the vertical axis control is relatively trivial, but will involve getting another PIC going 'cos I've just run out of I/O pins. Syncing it all up is a more intricate software problem.

Suz had set the task of drawing an oval as something that would impress her, and guess what? It now draws ovals at the press of a button. We figure we're not too far off producing a RepRap logo

now :)

No RS232 still. Adrian has given me his code, but I've been too busy tidying things up and drawing ovals to do the relatively simple code import. The breadboard area is much tidier though, with plugs fitted to many wires thus ensuring they don't get knocked out by fiddling experimenters or wandering cats. It might seem picky, but it leads to more repeatable experiments and more reliable results.

Vik :v)

Z Axis Stepper Report

Thursday, 18th August 2005 by Vik Olliver

We got the Z axis stepper motor working on command. We had a spare 3-way switch lying around and a limit switch from an old Amstrad printer. We hooked 'em up and used a modified stepper2 code on a broken pic to control the motor.

We've finally got round to labelling the motors, so now everyone can see what Vik's talking about.

Ran into a problem with the stepper motors: They get hot. Fast. In the testing stage, this hasn't triggered any more problems (Like Polymorph motor mounts melting) yet. I might link them to a small heat sink soon.

Ash & Vik :v)

3-Axis motorisation complete

Friday, 19th August 2005 by Vik Olliver

We've wired up all 3 axes of the carriage and got them under control of PIC microcontrollers. The turntable is not yet calibrated, but the linear axis (X) and vertical axis (Z) do self-calibrate on power-up.

Weedy little stepper motors from floppy drives did not have enough power to directly drive the vertical screw. Nor did a larger motor liberated from an old Brother printer. But 3:1 reduction gearing did the trick, as you can see in this photo. The vertical drive stepper is at the bottom of the carriage assembly:

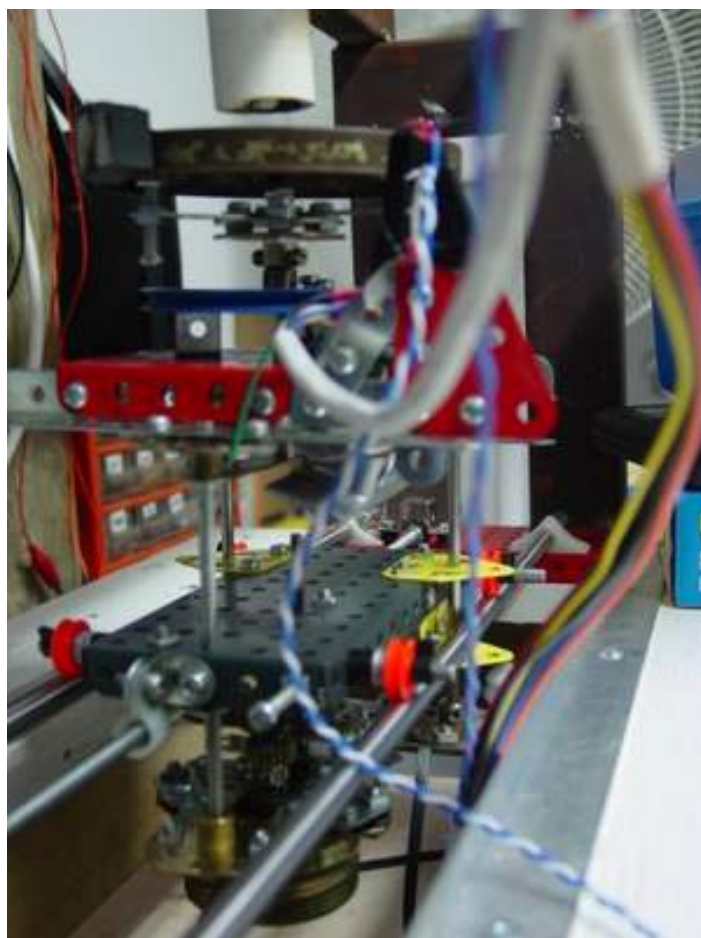

The existing control circuitry is starting to look a little complex, though all we have to add is the driver for the extruder and the thermal control for the nozzle heater:

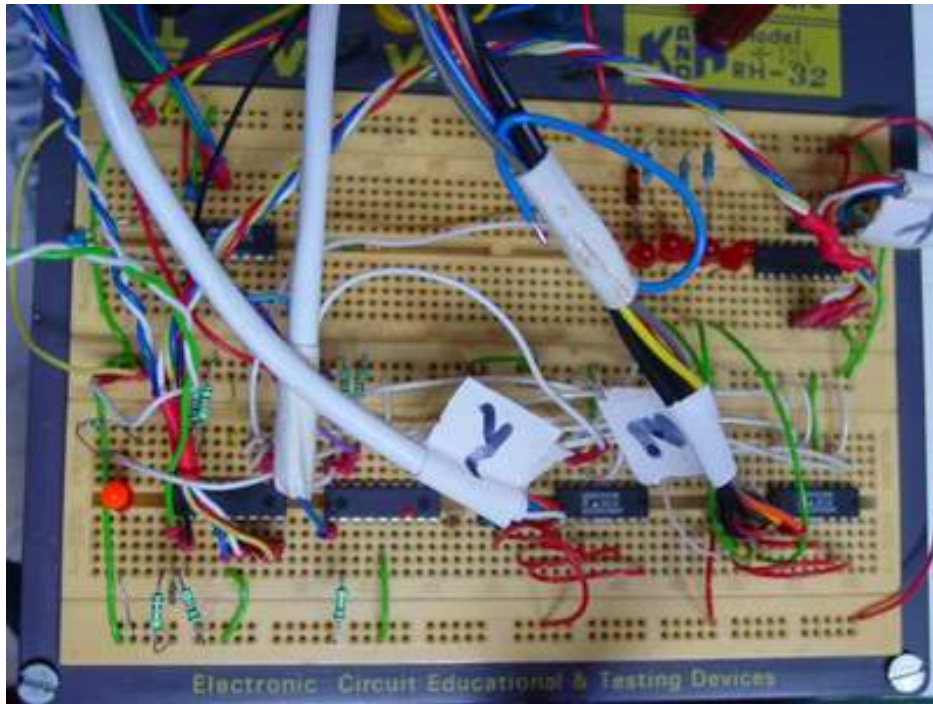

The illuminated LED lower left indicates that the vertical motion has hit the upper limit sensor. There is a manual override for vertical adjustment, unclogging nozzles etc. The 4 LED cluster is for checking stepper drivers. The drivers are the ones with axis-labelled cables next to them.

The RS232 **still** needs connecting. But we also need a nozzle and NZ has run out of cheap glue guns. Our attempts to use a thermistor as a current limiter failed, with the heater taking 4A and burning the PTFE insulation - bad thing. Evacuate lab immediately and ventilate.

We're getting close; I can smell it. Or is that more burning insulation...

Vik :v)

Ready-made heaters

Wednesday, 24th August 2005 by Vik Olliver

Last night Ash and I fitted our latest EVA nozzle to the Meccano feed mechanism. We've used the nozzle of one of the wrecked glue guns, replaced the tip with a 0.5mm one, and attached the Meccano supports to flanges on the nozzle.

As we've destroyed all the heating elements and are wary of vapourising more PTFE tape we've used 5W resistors as heating elements, holding them on with a hose clamp. Using the standard 12V supply and 27 Ohm 5W cement/ceramic resistors, we generate approximately 10W of heat. If we need higher temperatures, we change the values of the resistors. It's cheaper than buying nichrome and the ceramic bodies can be re-shaped to fit the nozzle body with a tile cutter.

No controlling electronics is required, but we have added a switch and indicator LED for safety.

We still need to re-shape the extruder drive mechanism as the new nozzle is a drastically different shape and size to the old one. The EVA feed doesn't line up properly and the end of the nozzle is too far above the turntable. We'll build a better adjustable support while we're at it.

Vik :v)

Meccano EVA extruder plans

Monday, 29th August 2005 by Vik Olliver

No pictures to show today, as work was fairly slow in New Zealand on the weekend. But our PIC serial port does at least connect to the PC to the point where we can turn a motor on and off with it.

Attempts to drive the 5V Meccano EVA feed motor with a relay resulted in a "smoked" PIC, due to accidental non-connection of backlash diodes. These are normally integral to the buffer but wiring them got missed out.

This has prompted the move to a 12V-only EVA feed. The DVD drive shown last month has now been dismembered and the motor/gearbox from the sliding DVD tray is being pressed into service. The only snag is that it works on 5mm shafts and the Meccano EVA feed is on 4mm so there's a bit of turning on the lathe to do.

Finally, a submission for a RepRap presentation has been made to LinuxConf Dunedin for 2006: <http://linux.conf.au>

Vik :v)

Head Design Released

Saturday, 10th September 2005 by Adrian Bowyer

I have (finally...) completed the design of Version 1 of the RepRap Polymorph extruder head. Here's a picture:

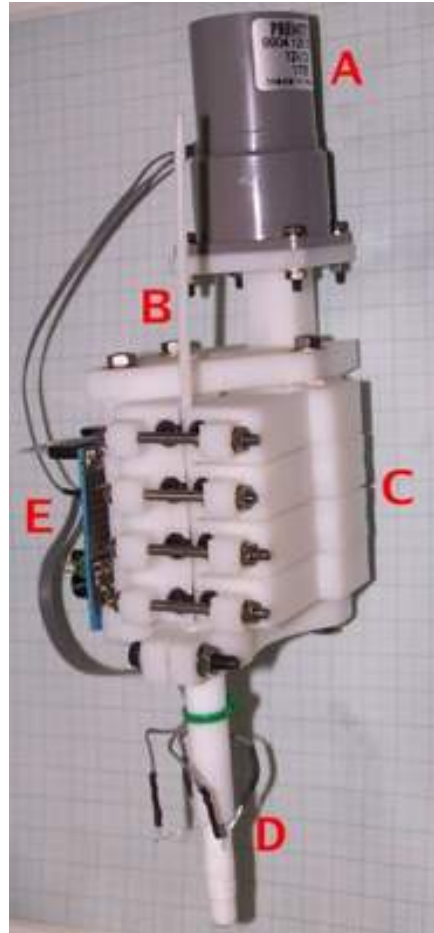

The large grid squares on the image are 10 mm across.

A 12v geared electric motor (A) drives a 3 mm diameter rod of the polymer to be extruded (B) by means of a stack of pinch-wheels (C) into a heated nozzle (D). The heated nozzle has a small hole in the bottom end out of which a stream of molten polymer emerges. The electronics for controlling the heater and the motor can be partly seen at (E). Polymorph has a low melting point of 62 °C, but the heater is capable of being controlled to temperatures up to 200 °C. At around 170 °C the Polymorph becomes inviscid enough to extrude easily.

For complete details of the extruder, including downloads of all its design files, see Item 11 in the [Reports, results, and documentation page of the RepRap Website](#), or follow this [direct link](#).

Meccano prototype's first restarted object

Saturday, 10th September 2005 by Vik Olliver

We managed to get the new 12V feeder drive controlled by a PIC, and have fitted a "goop shield" to the nozzle to prevent dribble messes over the turntable.



The top of the turntable has been fitted with an easier to clean cardboard plate. We might raid the local pubs for beer mats - hey! There's a good excuse! Our "goop shield" is a spare beer bottle cap - no relation - and we have wrapped the resistors with PTFE tape to stop "goop" dribbling through it.

We've produced two cylinders with a wall width of 1.0mm approx. The second cylinder was stopped (while we popped the EVA stick back into the heater) repositioned (Vik had knocked everything around a bit in the process) and cleanly restarted. This wasn't too difficult and the hardware is proving to be reasonably precise so far.

We have encountered a setback in that the hot-melt glue overflows from the nozzle, no matter how slow we put the feed at. This is not just causing dribble problems; it is also forcing the unmelted glue feed off to the side of the nozzle entry.

We're sure that we will find a solution soon, most likely involving gaffer tape or an old golf club.

Vik :v) and Ash.

Computer languages

Monday, 19th September 2005 by Adrian Bowyer

After extensive and detailed technical discussion (me: "How about X?"; other-RepRap-bods: "Seems all right...") we have decided on the computer languages to use in the RepRap project.

We shall use Java for all the software that needs to run on the computer controlling the RepRap machine. Most users will have Linux, Windows, or a Mac, and Java should be pretty platform-independent.

Inside the RepRap machine itself there will be one or more PICs (at the moment we're trying to make them all PIC16F628-P chips). These we will program in C via the SDCC compiler to generate .hex files for downloading. Occasionally we may also need to use PIC assembler.

First non-circular object printed

Tuesday, 20th September 2005 by Vik Olliver

Last night I ran off the first non-cylindrical shape from the Meccano prototype RepRap in EVA. It's shaped a bit like a keyhole and tapers as it goes up. It was done by programming the PICs rather than sending commands from a PC, pending my fixing of the serial control software that I mucked up. Here it is:



This illustrates several useful things:

- o We can produce non-circular artifacts!
- o EVA Produces fine filliaments on some corners, which are easily brushed off.
- o The indexing of the turntable by means of a magnet and reed switch is sufficiently consistent in operation.
- o It is possible to produce tapered objects.

All the layers fused beautifully, but the initial base layer was a little patchy possibly due to me depositing on cardboard. The turntable initially located itself under the head automatically, and after checking the EVA feed I created a stable and well-bonded base by running the bottom layer repeatedly without adjusting the height. Then it was just a question of enabling automatic control of the vertical axis and the object formed before my eyes.

Vik :v)

Why so quiet?

Tuesday, 11th October 2005 by Vik Olliver

We've been a bit quiet recently. Just to reassure you all, this means nothing more than we've had our heads down and we're busy. Files have been moving in and out of our CVS, and a major presentation is being worked on that will be made available to all. For those who happen to be going to LinuxConf 2006, I hope to have the Meccano prototype and a Polymorph extrusion head demonstrated as part of the RepRap presentation there.

ECONZ has generously donated more stepper motors to the cause, so I might upgrade the drive system at some point as the new ones are stronger than my salvage from the floppy drives.

The big push now from my perspective is to get some communications going between the PICs in a meaningful way, which Simon and Adrian have been preparing code for. I'm also stuck right in the middle of the preparations for Laingholm Volunteer Fire Brigade's 50th anniversary, which is no small task but will be over in a fortnight.

So, back to work.

Vik :v)

Removing floppy steppers

Tuesday, 18th October 2005 by Vik Olliver

Having survived a brief but rapid descent down the side of the Waitakere ranges with only minor injuries, I've replaced the stepper motor on the horizontal thread drive with a much bigger one that has a 7.5 degree step size. I now have more resolution than I can handle on that axis, and it runs much quieter.

I found that a 50mm length of 2mm i/d PVC plastic tubing, as used in irrigation and hydroponics systems, fits smoothly over the stepper motor shafts. This slips into a piece of 4mm i/d PVC tubing that has been screwed onto the end of the M5 threaded rod. This gives a smoothly rotating drive without going to the hassle of having to line up the motor and the rod precisely. I'd used the same materials before, but only as shim rather than as a flexible coupling.

It's much quieter and more reliable now - no skipping even under heavy load. I'll experiment with speeding it up, but Fire Brigade duties are getting in the way - I have to rig up some "light bars" for the celebrations in the hall, and that needs my 12V PSU as well as my time.

ECONZ Have donated heaps more connectors of the type used in Adrian's impromptu socket designs, and 200 LEDs. I can see we're getting set up for mass production in New Zealand well in advance!

Vik :v)

First Polymorph Object Made

Thursday, 20th October 2005 by Adrian Bowyer

I attached the new Polymorph extruder (10 September 2005) to the old Cartesian robot mentioned in the blog for 14 May 2005. Then I programmed the robot to build a rectangular block. It worked...

Here is a still taken at the end:

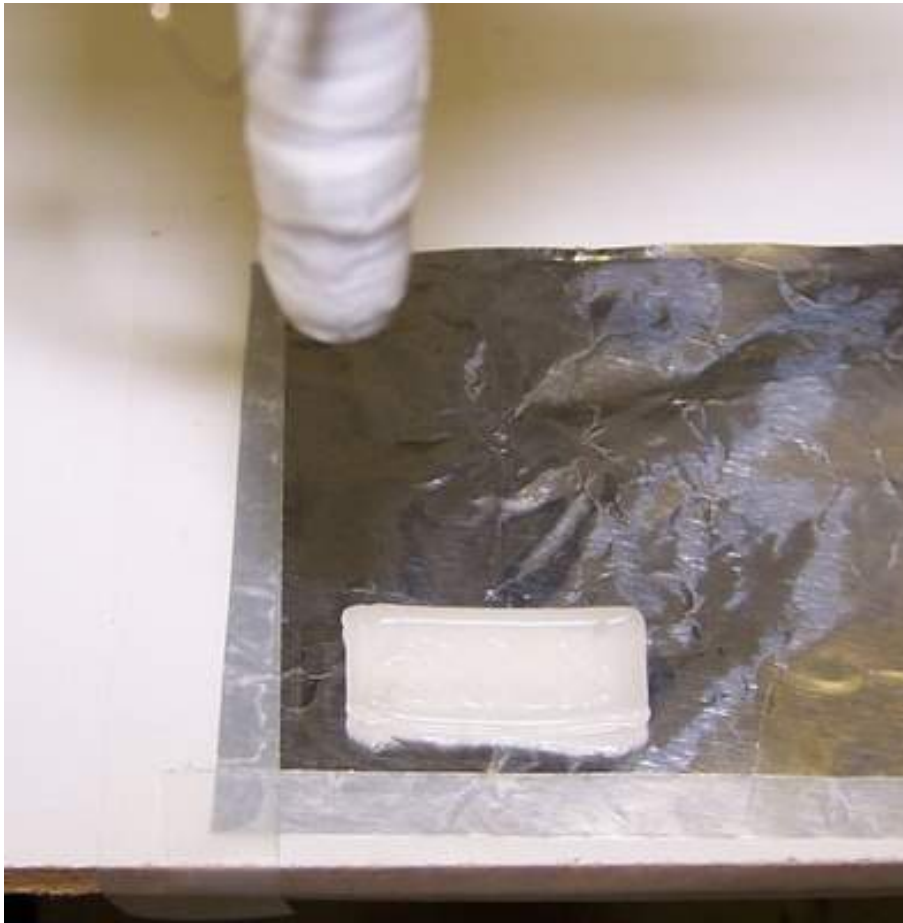

[Click here](#) for a Quicktime movie of the extruder working to make the block (N.B. it's a 20 MB file...).

Guy Fawkes Update

Friday, 4th November 2005 by Vik Olliver

Here in New Zealand, there is a lull before the happy, normal, sane people of Laingholm turn into rabid pyromaniacs and make life busy for us volunteer firefighters. So, time for an update.

Adrian has successfully made a screw-driven Polymorph extrusion head, having solved the problem of the Polymorph binding up the driving screw. The MkII head is about half the weight and a quarter the complexity of the Mk I design. I'll let him have the joy of filling in the details on how he did it.

I've been preparing presentations for the last fortnight (including my first mention of RepRap at NZCS) but have now started designing some of the RepRap-able parts for the raising and lowering of the turntable. Despite having a nice machine and lots of memory, designing such things as 79-toothed gears still takes quite a while. Ed's FDM design guide is invaluable for this. Here's the state of the work so far, the larger gears being around 100mm across:

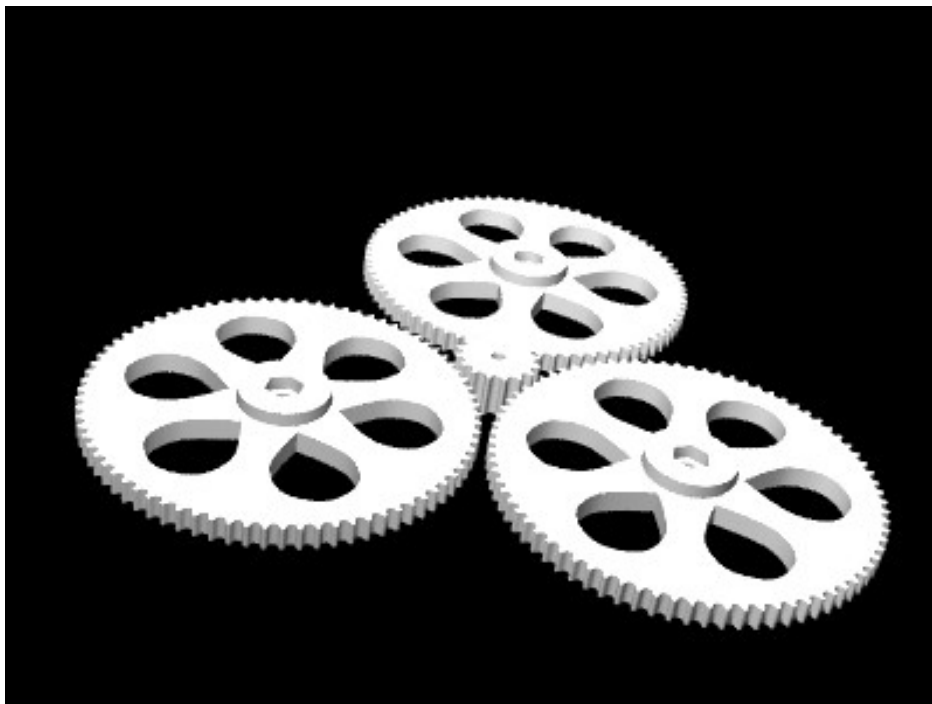

I've also taken apart an inexpensive but effective cordless 3.6V screwdriver as a possible power source for driving extruders etc. The one I have was NZ\$11 from Dick Smith Electronics (about four quid) and has a nice little planetary gearbox that should provide all the oomph we need - complete with "wall-wart" charger. Adrian's flexible MkII design will be able to cope with it. Here's the guts exposed:



New Extruder

Sunday, 6th November 2005 by Adrian Bowyer

As Vik mentioned below, I have got a new extruder design working (though he was too modest to say it is based on an original idea of his). Full documentation and downloads are available from the Extruder Version 2 section of the RepRap wiki.

Here's a picture:

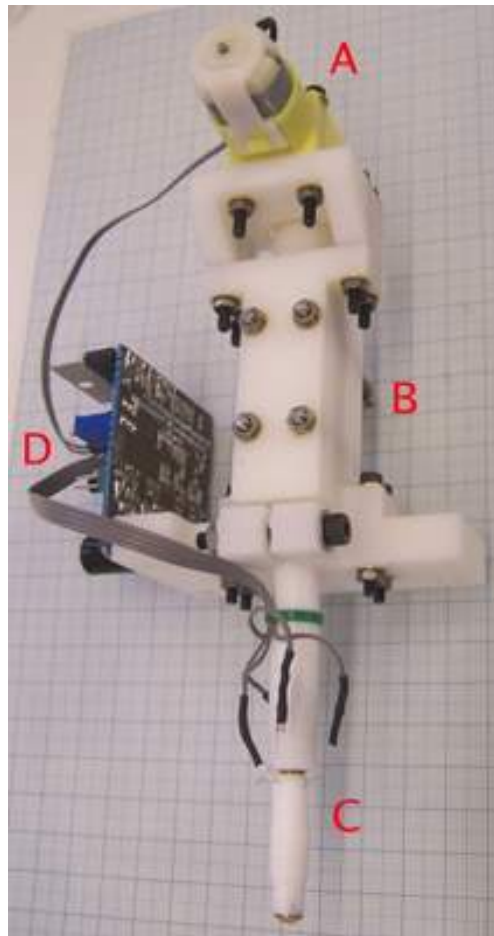

A geared electric motor (A) drives a screw chamber (B) in which a threaded rod is forced against a rod of polymorph. As the thread turns, the polymorph is pushed downwards to a heated nozzle (C) and is extruded out of the bottom. The control electronics is shown at (D).

This Version 2 design has many fewer parts than Version 1, those parts are cheaper and easier to obtain, and the overall mass of Version 2 (just under 200 g) is less than half the mass of Version 1.

Here's a picture of it building a small thin rectangular block.



Image not found.

RepRap Wiki

Sunday, 6th November 2005 by Adrian Bowyer

Simon has set up a wiki for all the RepRap documentation, for which many thanks to him (especially as he did it in a few hours flat...).

We will be putting all future documents up there, and gradually migrating the existing ones across too.

Wire wrapping test

Sunday, 13th November 2005 by Vik Olliver

I've been experimenting with the idea of using plain copper wire for conductors, as "bend alloy" has so far been shown to be unobtainable in NZ. The L-sectioned posts I'd blogged earlier don't look easy to fabricate, so I wondered about creating a 'trap' out of wire to hold chip legs and components in. I wrapped wire into 3 figure-of-eight shapes around some posts (the remainder were just to keep the wire out of the way) and pressed a PIC into the gaps, taking care not to actually touch the posts themselves:

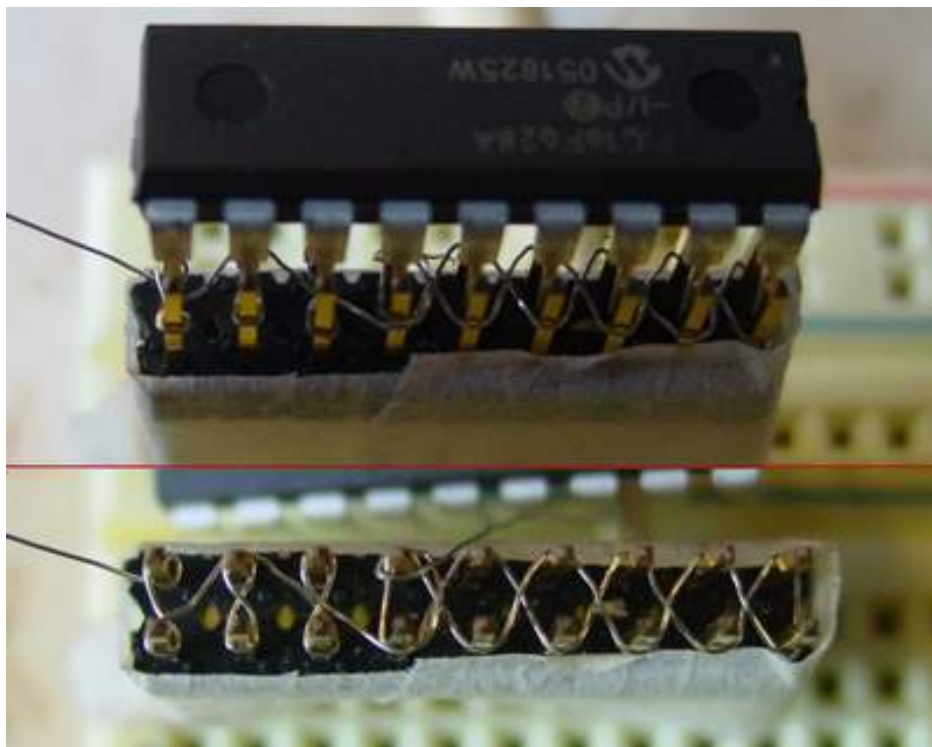

Even the single strand on the far left produced a contact resistance of <0.1 Ohms. A heated hypodermic could trail a wire around on a RepRap platform, and terminate the wires by pushing them into a Polymorph surface. Some form of cunning nipper would be needed to cut the wire off, a few mm clear of the end of the needle and fold it off to the side. I think the next stab at the Polymorph surface would then form the wire into a J-shape, creating a primitive barb to anchor the wire in the setting Polymorph. Once the wire is in place, of course, the RepRap can bury it in plastic if necessary.

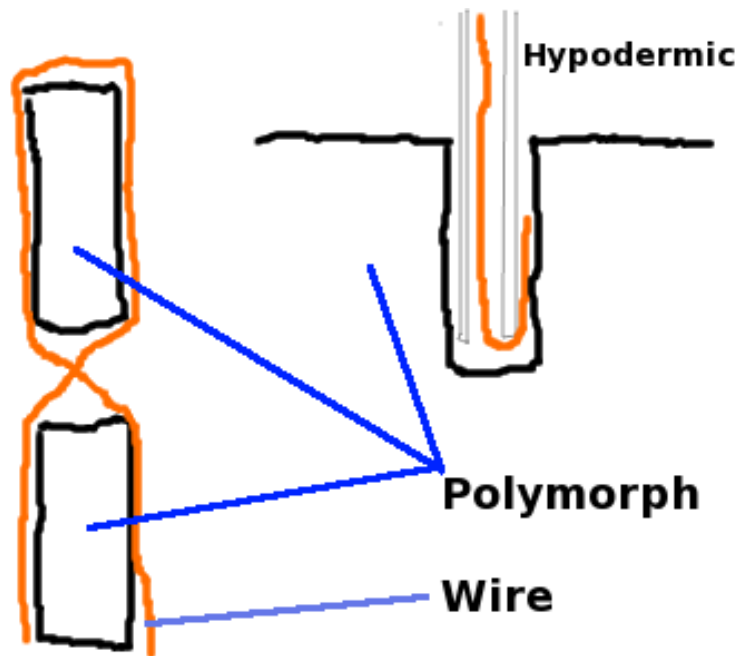

Do the assembled think it would be worth pursuing this concept? I can find a hypodermic and warm it up a bit to test the Polymorph anchoring. The wrapping would need some FDM'ing of suitable plastic posts of various shapes for straightforward wire-wrapping (junctions) and making sockets with. Suggestions on potential post shapes welcome.

Vik :v)

Turntable raising gears fabricated

Tuesday, 22nd November 2005 by Vik Olliver

Here's the actual gears as fabricated by the Stratasys. They came out quite well and mesh neatly:



Image not found.

You can't see the nut-holding collars in this photo because they're underneath. Now to create a "spider" to hold everything together.

Vik :v)

Insy Winsy Spider...

Saturday, 26th November 2005 by Vik Olliver

I've designed a spider to hold the gears together. The holes around the large central hole for the centre gear allow for the mounting of the stepper motor, some stiffening (if necessary), and the attachment of a turntable or linear axis across the top:

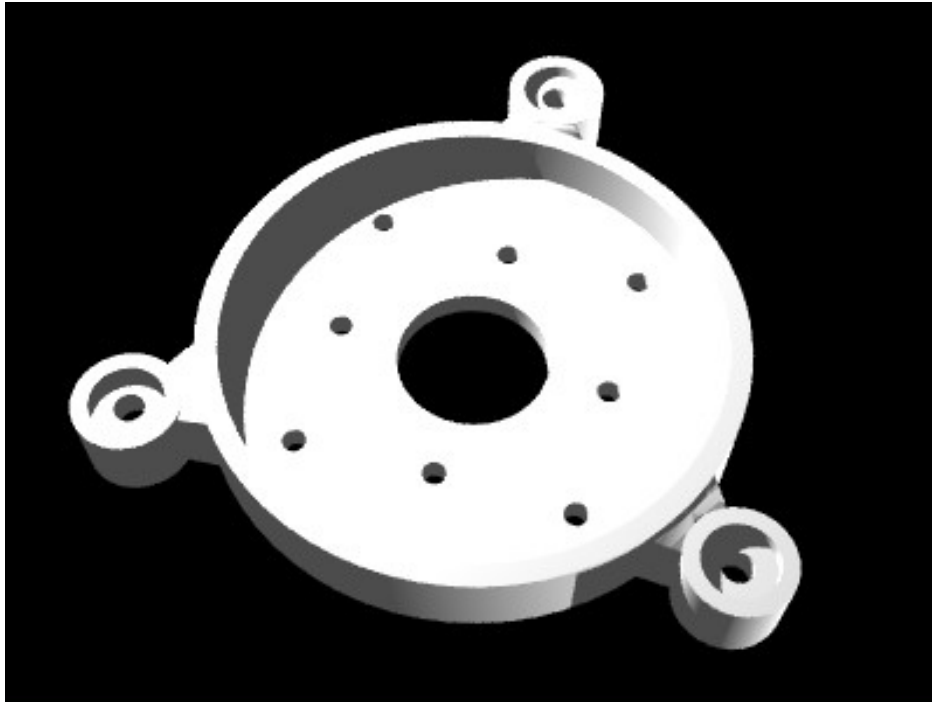

MK II Extruder, take 2

Sunday, 27th November 2005 by Vik Olliver

I've put a picture of the state of my MkII extruder construction in my personal page on the RepRap blog if anyone is interested:

<http://reprapdoc.voodoo.co.nz/bin/view/Main/VikOlliver>

Vik :v)

Join the resistance

Monday, 28th November 2005 by Vik Olliver

An idea I've been kicking around is to use the resistance of the nichrome heater element in the MkII Polymorph Extruder to measure its own temperature.

Adrian's circuit chops the current going through the coil. It might, I thought, be possible to measure the resistance of the coil while there is no heating current going through it. A quick experiment with a lighter showed a nichrome coil varying from 4.9R to 130R when I waved the lighter underneath it.

This isn't really my area of expertise, and I wondered if anyone else might have some thoughts on how it might be done. If we can remove the need for a thermistor, connectors, added assembly steps and wiring, then the device gets simpler - even if we have to add another regular component or two to the board.

Vik :v)

Our Carriage Awaits.

Thursday, 1st December 2005 by Vik Olliver

Here's a model of the carriage assembly that works on a piece of M5 studding. This will carry the gear assembly, in turn held by an orange spider at the top and bottom:

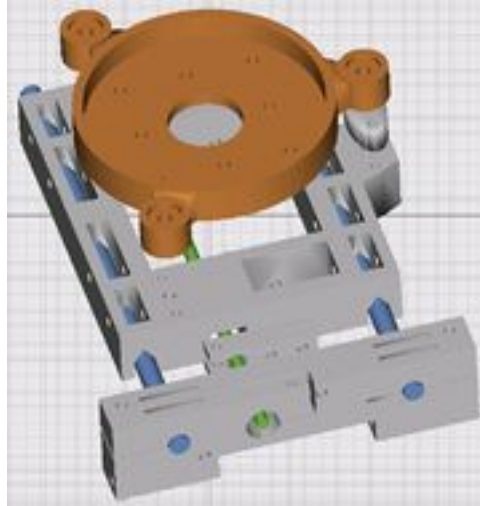

I'm uploading the Aol source files to [the Wiki](#) now.

Vik :v)

Polymorph and polycaprolactone

Tuesday, 6th December 2005 by Adrian Bowyer

I have now obtained a sample of polycaprolactone granules and used it in place of Polymorph. It works perfectly to make rods for the [RepRap extruder](#). I used granules of CAPA 6800 polycaprolactone (2-Oxepanone, homopolymer; molecular weight 80,000, CAS number: 24980-41-4) from

Solvay Interox Ltd.

Baronet Works

Lower Walton

Warrington WA4 6HB

U.K.

+44 (0) 1925 643210

The [Solvay website is here](#). CAPA 6800 is supplied by the company in 20 kg paper sacks, or 500 kg bags.

There is a more complete [write-up on polymorph on the RepRap Wiki](#).

Clamps & spider arrive

Tuesday, 13th December 2005 by Vik Olliver

The FDM'd clamps and spider turned up in the post. I spent last night picking the support material out from the gaps - I'll have to refine the clamp design, as there are a lot of fiddly nooks and crannies filled with support material. Still, the holes are the right size and in the right places.

I found the best tool for extracting the material from big, flat areas was a 1 inch wood chisel, flat side against the plastic you want to keep. It fairly rips through. Pokes deep holes in fingers too, damnit.

For slots, a craft knife works well, and for awkward areas I used a cobbler's awl. To clear out bolt holes. I "wood-pecker" drilled using a Dremmel with a 2.5mm bit, then punched out the remains with a screwdriver. My original plan of using a router bit on the Dremmel was a complete non-starter and my water-blaster won't shift the support material at all.

If there's one thing I've learned so far, it's not to design intricate little crevices that get filled with support material.

Vik :v)

Cartridge heater arrives!

Wednesday, 14th December 2005 by Forrest Higgs

The 120 volt, 300 watt cartridge heater that will be seated in the extruder block arrived just now. You would easily mistake it for a blasting cap except that the lead wires are too heavy duty. Everything needed to make the filament extruder is either on my worktable or in the nuts and bolts section of my local hardware store.

Building the filament extruder version 1.0

Wednesday, 14th December 2005 by Forrest Higgs



Image not found.

We collected the steel for the extruder too late to do anything with it yesterday. This morning I acquired a small mitre box and some fresh hacksaw blades and spent the rest of the day cutting the big chunks of steel bar and angles into smaller ones as per the design specifications. Tomorrow, after cutting the few remaining bits save the extruder block, I will round off the edges and corners with a grinder and, with a bit of luck, drill the holes for the bolts used to put it all together.

I also discovered that you do most definitely not put steel fresh from the steel yard onto a carpet.

Strange Economics...

Thursday, 15th December 2005 by Forrest Higgs

The Gingery design for the filament extruder depends on about 10 centimetres of arc welding rather than crossbracing to keep its frame rigid. I called a tool rental agency and discovered that renting a light welding rig for a day would cost me about \$100. Using Froogle I discovered that I could buy a complete light duty rig with accessories for \$85, shipping included. It will arrive either Saturday or Monday. My brother-in-law said that it can live at his house.

Screw-driven axis under construction

Thursday, 15th December 2005 by Vik Olliver

Here's a shot showing the bearing assembly under construction. The large rectangular part is the rail clamp for the screw-driven linear axis:



I got this rotating smoothly last night, but I've had an idea on how to simplify it further so no complete photos yet.

Also in the image are the spiders and gears. They're only held in place with bolts at the moment so I could check the spacing on the gears. It looks good.

The rail clamp itself is probably best split into 2 parts to simplify construction, the bolt holes need shaping so they are RepRap friendly, and the clamp surfaces could probably be about 0.2mm further apart. Other than that (and the hole I poked in my finger with a chisel) I'm very happy with the results so far. Next, I eagerly await the carriage component. Once we find out how much loading this can take in the real world, we'll have an idea on how large a mechanism we can fit on top of the vertical axis.

Oh, Austria Microsystems supplied 4096-step magnetic rotation sensor samples, including a prototyping board. These folks really know how to provide sample kits - I'm very impressed. If anyone wants to work in interfacing these to a PIC, do speak up:

http://www.austriamicrosystems.com/03products/products_detail/AS5045/description_AS5045.htm

Vik :v)

Screw-driven axis self-calibrates

Friday, 16th December 2005 by Vik Olliver

Here is the fabricated screw-driven axis, with the old Meccano carriage sitting on it. I've put the spider on top of the carriage so you can see roughly where things are going to sit:



The limit switch is not fitted in this photo - I need to drill a couple of small holes when I figure out exactly where they need to be - but when it is taped in place the carriage self-calibrates and returns to its default position.

The axis itself has 23 components, including every nut, bolt and washer.

Vik :v)

Jigging the Filament Extruder Frame...

Friday, 16th December 2005 by Forrest Higgs

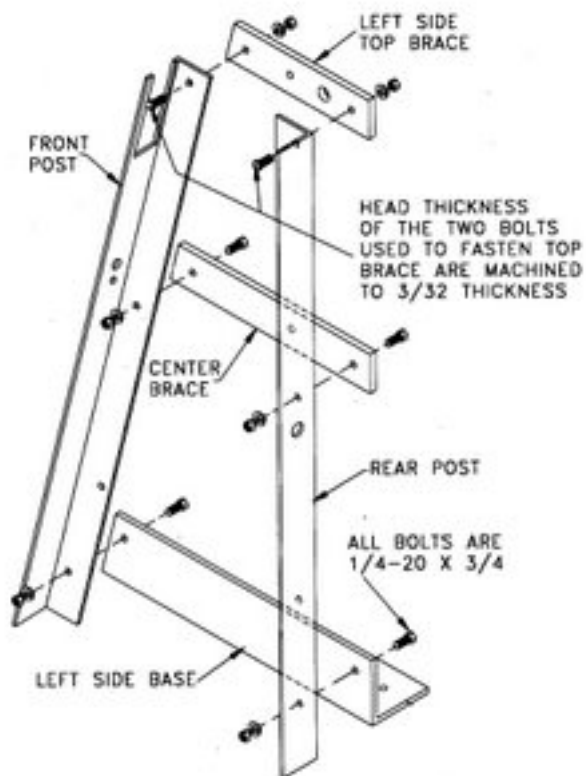

I bought a couple of C-clamps this morning and began to jig the frame parts together. There is still

quite a bit of cutting to do but the device is beginning to take shape. The big question now is whether I should just buy a half dozen smaller C-clamps and weld everything together save the extruder or stick to the Gingery design and use both bolts and welds. I suppose that if I want to tear it down and salvage the steel later the bolts plus welding would be the best bet.

Sawing off the extruder block proved to be less of a challenge than I had originally thought. I am going to drill it out this weekend. The drill press I have has no positioning vice so I have cobbled together a frame from some 3/16x2-1/2x2-1/2 angle iron and my C-clamps which should stabilise it on the drilling table quite nicely. I was worried that selecting a 1/2 inch diameter cartridge heater would cause me to have to realign the injector chamber. That has not proved to have been a problem, however.

Ready for the drill press...

Saturday, 17th December 2005 by Forrest Higgs



The Gingery design has detailed instructions about where you have to drill holes so that the steel parts can be bolted together. Fortunately, I remembered a little trick my father, who used to run an ordinance and repair depot for the Army, once told me about. Simply said, you use c-clamps to assemble the parts into their final form and then put the assembly under the drill press, removing one clamp at a time and drilling the holes for the connecting bolts through both members at the same time. Doing that is about ten times faster and a lot less error prone than drilling and afterwards assembling the parts.

I am also going to take a first run at drilling the extruder block for the piston and heater cartridge. Wish me luck on that. I've never tried to drill an accurate hole through four inches of hard steel in a close tolerance situation.

Central core of vertical axis ready

Sunday, 18th December 2005 by Vik Olliver

I've assembled the central core of the vertical axis. The 4mm bracing was needed, and stabilises the design beautifully:



All we need now are the electronics to drive the stepper motor (currently on a breadboard) and the carriage FDM component. Then the vertical axis can join the linear axis.

For those pondering how it works, the four inner rods are just bracing. The three outer rods are connected to the large gear wheels like this:



When the motor goes round, a pinion gear on it drives the big gear wheels. These rotate the 3 larger threaded rods. The whole assembly is suspended from the three nuts on those rods. The nuts are held still, and the whole mechanism moves up or down depending on which way the 3 rods are rotated.

A turntable or stage will be attached to the top of this assembly.

Vik :v)

Progress on the filament extruder...

Monday, 19th December 2005 by Forrest Higgs

Just to keep everybody in the loop on the filament extruder project, the heavens opened yesterday and we got about 75 mm of rain so I stayed in for Sunday rather than trekking out to my brother-in-law's workshop in Carmel Valley. I also found myself facing the old maxim that says that the first 90% of a project takes 90% of the time and the last 10% takes 90% of the time.

I have to cut a new piston alignment block, buy a rat-tailed file to sort out a bolt connection hole in the frame that slipped while I was drilling it with the drill press and finally make another expedition to the hardware store to get a few drills and threading taps that I hadn't bought before.

A trek to the electronics supply shop across the peninsula to buy some ceramic wire nuts, a circuit fuse holder, an indicator light, a length of power cord and a plug is also on today's schedule. This thing has alotof bits.

I will also be buying a half-inch threading tap to see if it is feasible to use a brass plumbing plug for the extruder die. That will mean that I can screw into the extruder block rather than brazing it in as per the plans. If that works I can swap out extruder dies instead of having to make a new block and heater cartridge for each time I want to make a different diameter filament. After having drilled one of those blocks I am not anxious to have to make them as a regular occupation with the WWII era Navy drill press that I have.

Meccano on steroids...

Monday, 19th December 2005 by Forrest Higgs

Doing some web searching I ran across this little company in southern California...

<http://smi4motion.com>

They sell bits, subassemblies and complete positioning systems. Their catalog...

http://smi4motion.com/2Products/PDF/SMI_General_Catalog_1.02.03.pdf

...is a fun read. As is their price list.

http://smi4motion.com/price_book.htm

Heat Testing the Extruder Assembly...

Tuesday, 20th December 2005 by Forrest Higgs



I looked after several small but important jobs on the filament extruder today with the grinder. First was prepping the end of my bar of 1x1-1/2 inch cross-section bar so that I can cut a new guide block for the extruder piston.

More importantly, I ground down the end of the piston as you can see in the photo so that it can be attached to the injector handle of the system. I got it to .001 inch tolerance which is not so bad with a grinding wheel.

Finally, I heat tested the assembly to 220 degrees Celsius to see if expansion was going to cause binding in either the piston or the cartridge heater. Although the piston fits quite tightly in the extruder cylinder there was no heat expansion binding and the cold cartridge heater was readily able to fit into its slot.

There are a few extra bits of assembly to be done but I will be putting those off until my welding rig arrives. After that all that remains is to wire up the heating circuit and we are good to go.

Polymer needed

Friday, 23rd December 2005 by Adrian Bowyer

Something that the RepRap project could do with is a thermoset resin that will go up to 200 - 250 C. That way we'd be able to create moulds by RepRap for high-temperature parts and make them at room temp. But all the everyday (i.e. cheap...) thermosets that I can find flake out around 170 C.

Does anyone have any suggestions?

Vertical platform successful test - 500g+

Friday, 23rd December 2005 by Vik Olliver

I'm pleased to report that the vertical axis is performing well in the testbed, and can carry a load in excess of 500g smoothly up and down. When things quieten down a bit - I've got the family around - I'll get cracking on the stage axis.

But now I sign off for the next few days of Christmas fun, and wish all a Merry Christmas, Frohe Weihnachten, or whatever variant of the solstice festival lights your festive candle.

Vik :v)

3D Cartesian axis, take 1

Wednesday, 28th December 2005 by Vik Olliver

With a fair bit of help from Ash, I've combined the Meccano, FDM and bolts approaches to come up with a functional 3D Cartesian axis. No end-stops yet, and haven't powered all motors simultaneously yet. But definitely all headed in the right direction. The top stage sits on 4x M6 150mm bright plated bolts and there's quite a bit of polycaprolactone involved:



Please excuse the mess in the background. We're still recovering from giftmass and my Brother-in-law seems to have neglected to take Rebecca or Laura back with him. They are taking an interest in Uncle Vik's experiments and are making references to "Dexter's Lab", whatever that might be. For reasons I fail to understand this involves them stealthily turning the machine on while vital parts are not in place, or are hardwired to inopportune settings.

Vik :v)

Welding Rig Arrives!

Thursday, 29th December 2005 by Forrest Higgs

My cheap Chinese 120 amp welding rig arrived today. The mask was the worse for wear so I acquired a new one locally along with 2 mm welding rods so that I can get a decent duty cycle out of the dinky thing and leather gauntlets. I plan on doing some practice welds tomorrow before working on the extruder frame. Wish me luck.

Additional primitives for Aol?

Monday, 2nd January 2006 by Forrest Higgs

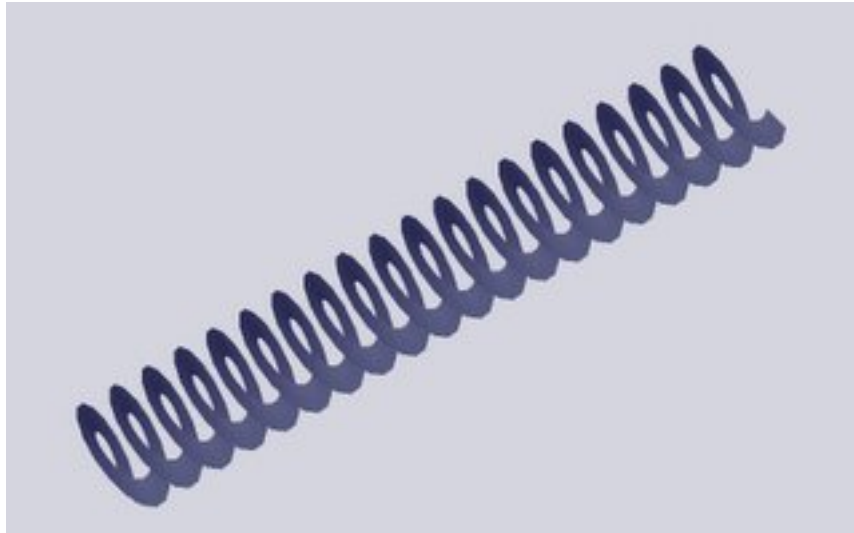

Our rainy season has arrived with the consequent floods, landslides, cold and humidity making staying in the workshop a very unpleasant experience. Rather than waste the time I've started getting acquainted with Aol indoors in the warm.

While I am awestruck with the capabilities of Aol, the paucity of primitives has made many modeling tasks tedious and others downright impossible. It seemed that Aol would be a lot more useful if a few extra primitives like cones, hexagonal prisms and helices were added. In that Aol allows for the importing and exporting of Wavefront object files I have begun writing a few simple programmes to generate some of the forms I need directly instead of building them up within Aol using boolean operators and curves. My projects right now are to describe an auger and a threaded rod.

As you see, so far I've generated the helix necessary to building both of those two forms and I've got a start on the threaded rod.

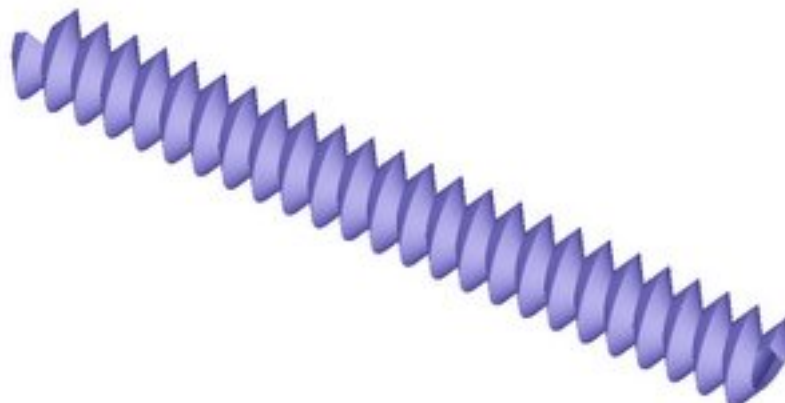

If anybody has any pet peeves with Aol that would be ameliorated with an imported object file not easily buildable with the existing primitives or two let me know and I will see what I can do. I am thinking that it might be nice if I made the specification and building of such objects accessible over the web and intend to do that for a few shapes as soon as my son gets the ASP specification working on Apache in our server.

Simple 3D Scanner

Monday, 2nd January 2006 by Adrian Bowyer

Steve Baker has put an open-source design on the web for an easy-to-make 3D scanner. You can find details at: <http://www.sjbaker.org/projects/scanner/>.

What eD's doing

Wednesday, 4th January 2006 by eD

Happy new year Rappers! After narrowly avoiding casualty by strapping sparklers to stunt kites, I'm back in to the self-replicating groove. This post is to let you know what I'm working on.

I'm developing a mechanical 3D rig, similar to Vik's. The top tray will be a bog standard carriage assembly:

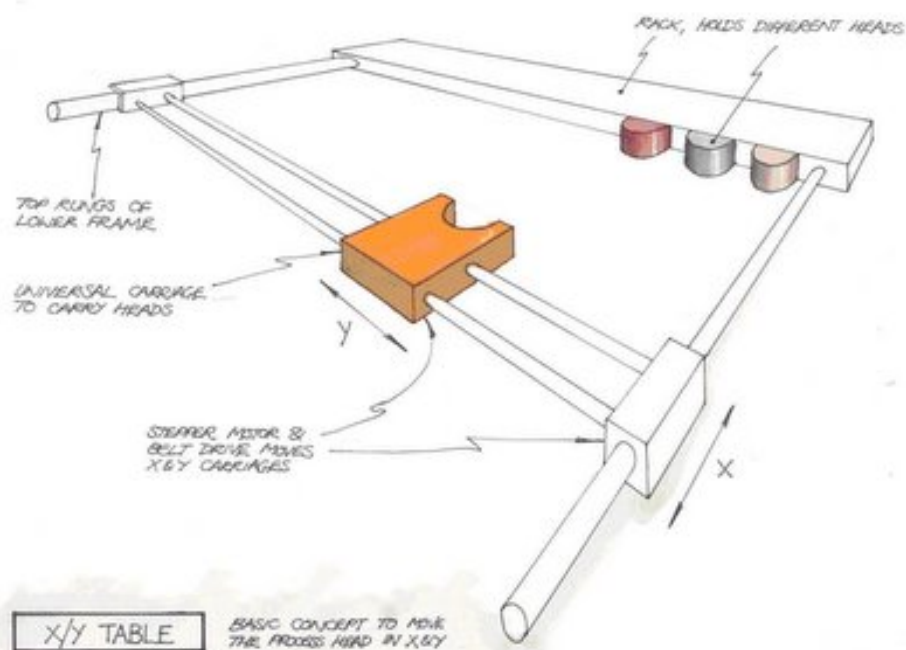

The trick to these things seems to be in the z-axis. Whereas Vik is using studding and a spider to move the z-axis, I'm exploring the possibility of using string. Here's the general concept:

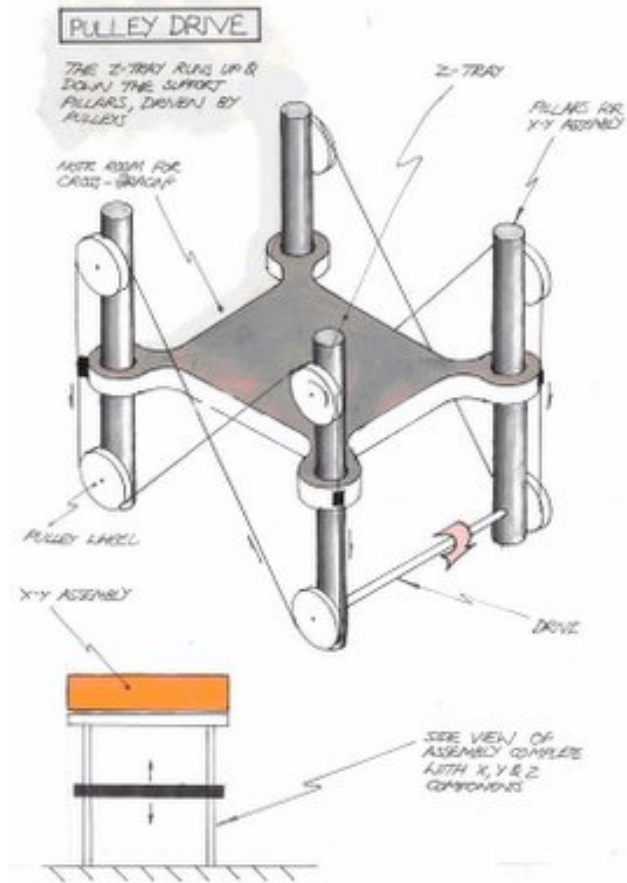

I'm currently working on how feasible the idea by building an accuracy test rig. Will keep you posted...

eD

Threaded Rod Object done...

Thursday, 5th January 2006 by Forrest Higgs



Okay, the routine that creates threaded rods in Wavefront Object format for Aol is pretty much done. I've got it creating a bound solid that works with Aol's boolean feature, though what comes out of the boolean operations can be a bit wierd at times. I'm not sure whether this sort of object is simply too complex for Aol's boolean operator routine or if the routine requires something like a right hand rule for outward facing polygons. I may have some problems with the polygon loop descriptions and got a few of them backwards.

Now I've got to throw in some parameters to dictate the pitch and depth of the threads. You can already control the number of turns of the thread and the resolution of the object.

Anybody who needs one or more of these Wavefront Objects for presentation work in Aol let me know your requirements and I will try to grind them out for you. After I get those extra parameters put in I will be going on to create an auger object for my version 2.0 filament extruder design project.

Pulley accuracy test rig

Friday, 6th January 2006 by eD

Here's the test rig I'm using to see how accurate a pulley transmission will be. The string is paracord 2mm (nylon?). After putting this on the force tester, strain and creep factors were surprisingly high. Although it will just about do for the time being, I'll need better performance for Mk 2. Am thinking insulated electrical wire is a useful resource here?

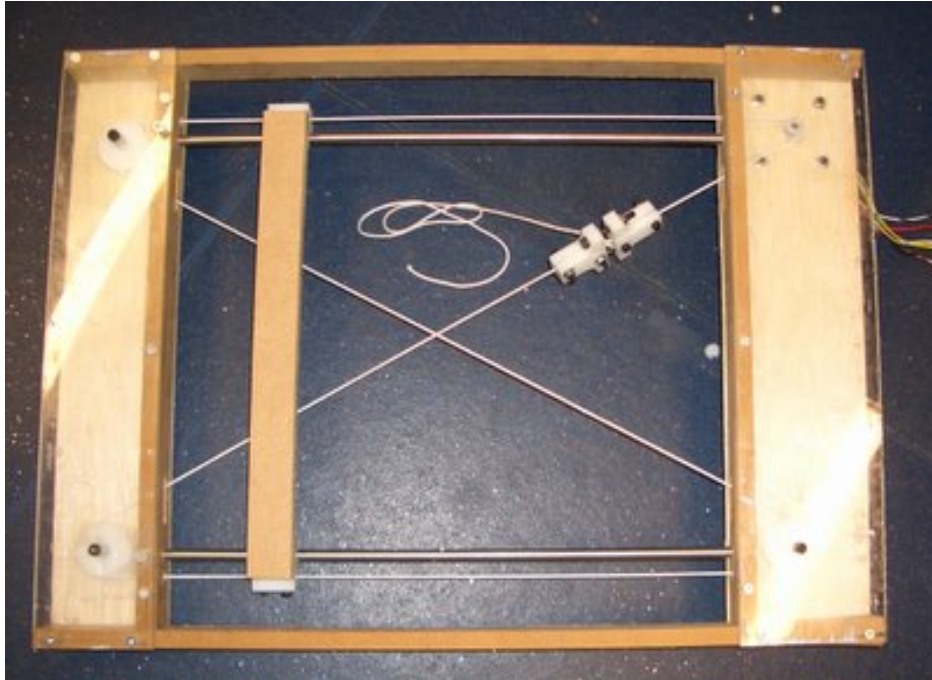

Results on the nylon cord will follow next week.

eD

Duplicate Extruder Mechanism Mk2 Operational

Saturday, 7th January 2006 by Vik Olliver

Ash and I have just got the first bit of Polymorph extruded from the Mk2 that we're building from Adrian's parts. We're using a TIP31C to switch the heater on and off, supplying the switch current from a simple pulse output on a PIC. Motor is operated manually by the two of us. Not built Adrian's AD stuff yet, hope to have something together by LinuxConf 2006 in a fortnight or so.

The nozzle exit hole was 0.5mm diameter and the outflowing Polymorph between 1.5 and 1.4mm in diameter - somewhat more than expected. Our average nozzle temperature was 105C.

I've put a page up in the Wiki on this one because it uses halved washers and Polymorph to make the half-round bearings called for in the design.

Vik :v)

And finally the auger...

Saturday, 7th January 2006 by Forrest Higgs



Which lets me get on with modeling the version 2 filament extruder.

Weekend Design Charrette

Tuesday, 10th January 2006 by Forrest Higgs

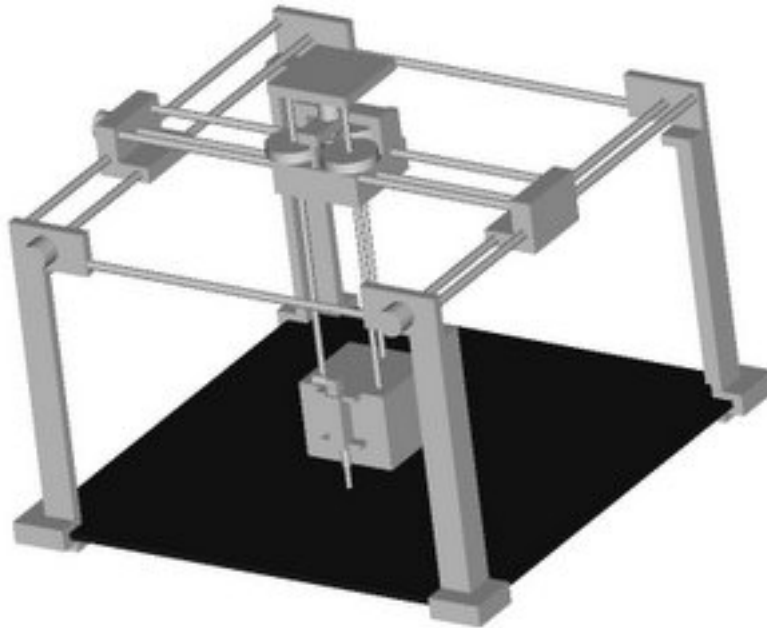

I spent the weekend using Aol to explore the volumetric aspects of using existing design approaches to create a Cartesian reprinter machine. The chief difference between the machine designed and existing efforts is that the extruder rather than the working surface is moved along the vertical axis.

A 12 mm plate of tempered float glass is used for the working surface. The machine's footprint is roughly 90x90x60 cm. The working volume for the design is about 70x70x36 cm.

Second Round

Wednesday, 11th January 2006 by Forrest Higgs

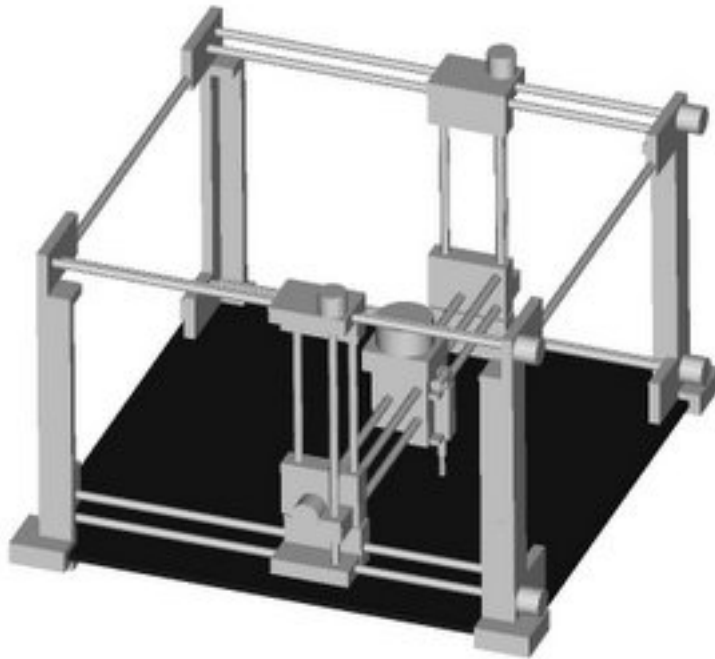

The more I looked at this weekend's design the less I liked it. It just lacks elegance. I hate designs that degenerate into more patches than design.

Last night I had a small epiphany and threw out the geared vertical axis drive and decided to do the whole thing with threaded rod drives. This design emerged from that restriction.

I think that this one is stable enough to use for an anvil. It looks to me to be an intrinsically stable design, which my last effort was not.

It has seven steppers. I am pretty sure that I could reduce that to four, though that would mean adding some material to the design, something I hesitate to do. I would rather use a lot of small steppers working in tandem than fewer, larger ones.

I will probably hate this one tomorrow, too... ..but that is what doing design charrettes is all about, hey? :-)

PCB production

Thursday, 12th January 2006 by Adrian Bowyer

We had an idea for making PCBs in a RepRap machine more or less directly, as opposed to the usual route of masks, photoresist, UV lamps, and ferric chloride solution.

Instead use electrochemical machining. I put a blank PCB in a bath of concentrated salt (NaCl) solution and connected it as an anode to a 12v supply. I used a soft-iron lead from a resistor as the cathode and held it a very short (0.5mm? I didn't measure it) distance from the copper of the PCB. The cathode had plastic sleeving round it in an attempt to cut out extraneous "sideways" currents. I set up a little fish-tank pump to circulate the solution and squirt it directly at the cathode to stop local build-up in solution of reaction products.

When I turned on the current (about 200 mA according to the meter) it punched a hole through the copper pretty quickly (about a minute). But the hole was about 2mm in diameter, which was a bit big.

I'll do some more experiments and blog some pictures soon.

If it can be made to work you could have an array of cathodes, each switched on and off as the array is scanned over the copper surface in X and Y to remove the copper in the pixel pattern of the PCB you want. If the scan happens from one edge of the board to the other, there is always going to be continuous copper on the unscanned side to ensure that islands (that cannot be removed as no current gets to them) don't occur.

Third Round

Friday, 13th January 2006 by Forrest Higgs

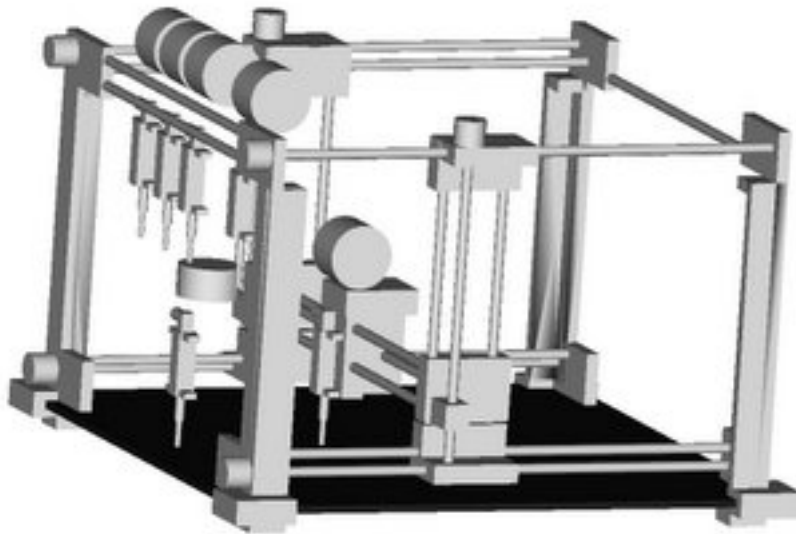

I did a quick volumetric study last night and this morning to explore the issues implicit in docking MK2 extruders in my godzilla reprop design. Not to many problems popped up.

The design accomodated 5 MK2's in a row or 10 in two rows if you sized the filament can down slightly and turned it on its side. One of the big cans will give us 50-60 hours of continuous operation. If you had two extruders of the same specification you could insure pretty much uninterrupted operation.

It seems most reasonable to have the dock use spring steel clips and put a servo driven coupling device in the 3D positioning head.

Fourth Round Dieting...

Monday, 16th January 2006 by Forrest Higgs

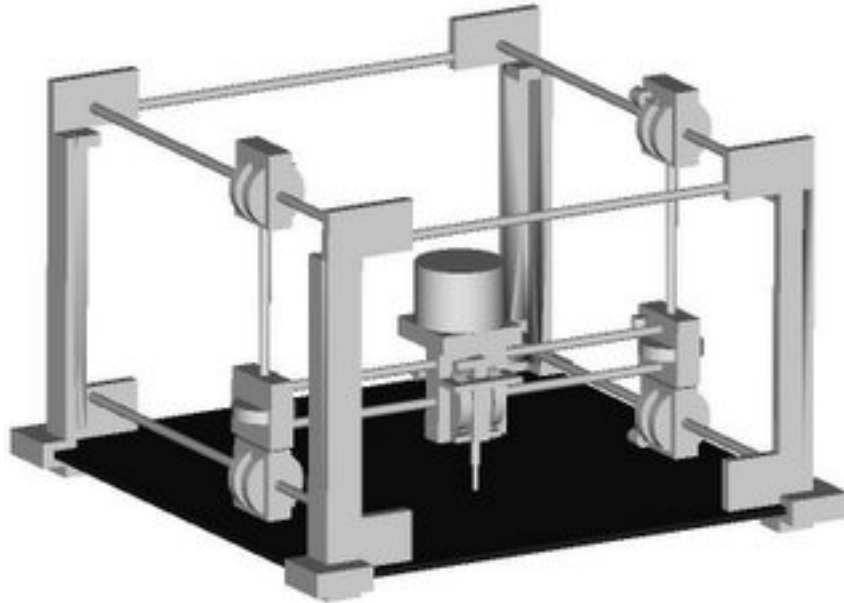

I shifted the design over to DC encoded motors from steppers from standard steppers. I also fixed the threaded rods and made them do double duty as structural members. This entailed moving the motors out onto the moving platforms, a move that will require some bit of coiled power cord which wasn't required before.

Please note that cross-bracing isn't shown.

The net result was that the design shed nearly 22 kg of expensive steel rods and several kilograms of polymer.

The quantity survey takeoff on the design is now...

Polymer - 9.5 kg

Steel - 10.3 kg

Glass - 21 kg

The design specifies 16 mm threaded steel rods. It is possible that smaller diameter rods may work or that we can thread tubing. Losing half of the rods mass out of the middle of the cross section would lower the rod's strength only about 10% if memory serves.

Make your own plastic for RepRap

Wednesday, 18th January 2006 by Adrian Bowyer

Vik has discovered a useful web page on the synthesis of polymers. It's at:

<http://www.chemsoc.org/networks/learnnet/green/docs/plastics.pdf>

The one we're considering is polymerising lactic acid, as that can be made by fermenting starch from biomass (which is self-replicating, like RepRap...).

Closing in on Godzilla...

Wednesday, 18th January 2006 by Forrest Higgs

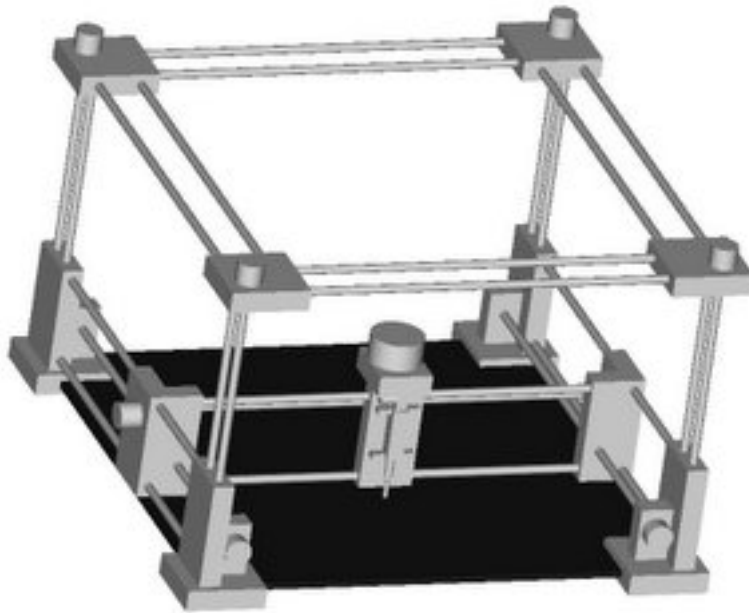

It's big... it's ugly... it uses seven steppers... but I think it will work. Work space is about 750x750x300 mm. It can fabricate something with a 1000 mm maximum dimension. It has a theoretical resolution of .01 mm.

The design has several advantages. It's scalable and the steppers don't have to be very big. I swapped around the axes so that the z axis, which has four steppers, also requires the most torque. The vast majority of the stepper usage will be limited to three steppers rather than five, as it was in the first design iteration.

I've specified NEMA 17's, which are probably overkill. I can get them for US\$9.95/unit, though. If Simon's experiment is successful I'll be able to run this with a 120-150 watt power supply and three controllers.

There is also no reason whatsoever why we can't use it to fabricate a stepper-powered lazy suzan that we can centre in the work space and use the rewrap along one centred axis to make radial objects like gears and such not till the sun goes cold.

I haven't shown cross-bracing.

Axis controller & extruder prototype boards

Friday, 20th January 2006 by Vik Olliver

Here's the axis controller I've built mostly following Simon's plan. It uses a ULN2803 octal driver and is currently only wired to drive one motor. It can drive two. I've uses microswitches for the limit sensors, and so only need pull-downs on the inputs. The 5V supply has a large heatsink because I might need to drive other things off it while at LCA2006 (the LED is for user confidence only).



Image not found.

There are no comms on it yet, but it has manual controls for stepping backwards/forwards. The red dot on the PIC indicates that I've blown up the serial interface on this chip. The whole thing cost about NZ\$20 to build using stock parts from Dick Smith Electronics - our local hobbyist electronics store.

The extruder controller below was also assembled from DSE parts at a similar cost. It differs from Adrian's design in that it used TIP31 transistors to control the motor and heating element. The one strapped to the sheet of aluminium controls the heater.



Image not found.

I've put the MAX233 RS232 converter on this board too, but it can be hacked off once development is complete. As you can see, both boards are relatively simple. What you can't see is that no tracks need to be cut for construction.

Vik :v)

Concrete ideas

Monday, 23rd January 2006 by Vik Olliver

One low-cost way of speeding up the construction of large parts might be to produce a hollow part and fill it with some gunk. Epoxy is quite expensive, metacrylate resin is a bit better, and concrete is relatively inexpensive. Environmentally, all have issues and are not recyclable but there are low-carbon concretes being developed.

The part would need to have built-in keys to ensure the filler remained in place, and cross-bracing to ensure it did not bulge when filled.

Vik :v)

High Temperature Materials

Monday, 23rd January 2006 by Adrian Bowyer

By high I mean 200 - 350 °C. A couple of weeks ago I blogged a request for materials that are easy to work with and that would allow RepRap to have some parts that are reasonably refractory. Forrest has been looking around, and has come up with some interesting sites:

<http://www.azom.com/details.asp?ArticleID=1458>

<http://www.mkt-intl.com/ceramics/machinable.html>

and

<http://www.cotronics.com/vo/cotr/pdf/onepg700.pdf>

The last is about castable materials, and of course RepRap should be able to make moulds with no problem at all.

Update on the Gingery filament extruder...

Monday, 23rd January 2006 by Forrest Higgs

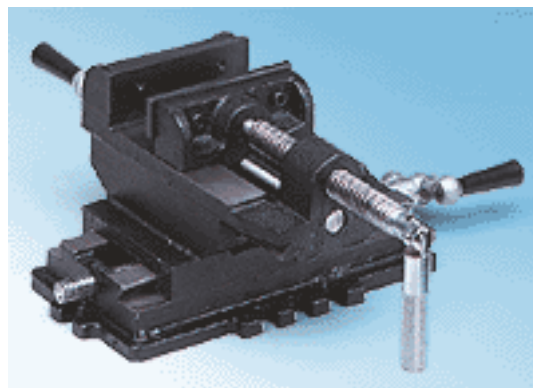

I finally learned what to call the little positioning table (a cross-slide vise) on a drill press, something my WWII era Black and Decker navy drill press doesn't have. Once I had the name I was able to find a deal on a good machinist's cross-slide vise for US\$25.99 on the web. With that installed I will be able to operate the drill press by myself and take on tasks like converting brass bolts to extruder barrels without the fear and loathing that such tasks had previously for me.

It finally stopped raining and dried out this weekend so I packed up the Gingery extruder and drove out to my sister and brother-in-law's place to learn how to weld. I spent a very frustrating

hour learning how to strike an arc. After that things moved along and I got the welding on the extruder frame done. I think that I must qualify for some prize for ugly welds, but they are strong and a grinder forgives many sins. My US\$65 Chinese welding machine seems to do the job quite nicely. :-)



I took some pictures of the welded frame so that I could share the shame of my ugly welds with the team.

Steppers for Africa!

Tuesday, 24th January 2006 by Forrest Higgs

I took delivery on the steppers in one day. I wasn't expecting them till maybe Friday so it came as quite a shock to me when the UPS man pitched up a few minutes ago.



I'll be transhipping part of the order to Vik and Simon as soon as I get the address for Vik's US maildrop.

Here is a closeup with a ruler so that you can get the scale of them. They're NEMA 17's and can be found on Lin Engineering's web catalog at...

<http://www.linengineering.com/site/products/4118.html>

They're 4118S's and weigh in at 0.4 lbs (182 g) each. They draw 2.5 amps at 24 volts and put out 45 oz-in's (3240 g-cm). For Simon, they've got four leads. I hope they do the job.



Capturing OpenGL data for prototyping

Wednesday, 25th January 2006 by Forrest Higgs

Recently, we had a blog about an open source 3D scanner. Here is another opportunity in that area. A lot of 3D information banging around the internet is in OpenGL format. Now you can grab 3D descriptions out of those visualisations for prototyping and other uses.

OGLE (i.e. **O**pen **GLE**xtractor) is a software package by Eyebeam R&D that allows for the capture and re-use of 3D geometry data from 3D graphics applications running on Microsoft Windows. It works by observing the data flowing between 3D applications and the system's OpenGL library, and recording that data in a standard 3D file format. In other words, a 'screen grab' or 'view source' operation for 3D data.

The primary motivation for developing OGLE is to make available for re-use the 3D forms we see and interact with in our favorite 3D applications. Video gamers have a certain love affair with characters from their favorite games; animators may wish to reuse environments or objects from other applications or animations which don't provide data-level access; architects could use this to bring 3D forms into their proposals and renderings; and digital fabrication technologies make it possible to automatically instantiate 3D objects in the real world.

<http://ogle.eyebeamresearch.org/>

Steppers vs. Servos

Friday, 27th January 2006 by Adrian Bowyer



At the RepRap project we have a never-ending discussion about the relative merits of stepper motors (simple, implicitly digital, but low torque and expensive) and DC motors (more complicated to control, but high-torque and cheap). This small discussion mirrors a much larger one that has been going on for years in the machine tool and robotics industries. It hasn't been resolved there, so we probably won't arrive at a definitive answer either.

To start with, RepRap will most likely use steppers, as we don't need a lot of torque (additive manufacturing is inherently very low force) and their simplicity of control cuts down on electronics - a big bonus.

However, I thought I'd see if I could make a very cheap and simple DC digital servomotor using rapid prototyping. It's depicted above. I've put preliminary details on the RepRap Wiki.

Torque Calculations for Vertical Power Screws

Monday, 30th January 2006 by Forrest Higgs

Several of the RepRap team are using stepper-driven threaded rods to drive linear positioning axes. Since torque required for the horizontal axes of our RepRaps is proportional to the product of the friction coefficient and the load and since the extruder is very light there is typically not much worry that even the smallest stepper motors salvaged off of printers and disk drives will be up to the job.

The vertical axis is another matter, however. In my own design the vertical axis steppers must lift not only the extruder but also the positioning systems, structural parts and guide rods for the horizontal axes. In other designs being developed the whole working surface plus whatever it is that is being fabricated wants lifting.

After I acquired the high torque NEMA 17 steppers I noticed that the 24 volt power supplies that they needed for achieving their peak torque performance were considerably more expensive than the much more ubiquitous 12 volt supplies for a given watt rating. Checking with the manufacturer I learned that while there was no real problem with using 12 volt supplies with them I could expect their torque performance to drop off by roughly half with the halving of the voltage supply. I then began to wonder whether the four NEMA 17's operated with 12 volt power were up to the job of moving the vertical axis loads on my very large, heavy RepRap design.

I was able to quickly establish from load tables on screw jacks that they ought to do the job. Shortly afterwards I found a little paper giving a methodology for calculating such torque requirements. I've reworked the methodology therein into the attached paper which you might want to use if you have similar worries about stepper loading.

<http://reprapdoc.voodoo.co.nz/pub/Main/FAQ/TorqueCalculations.pdf>

I ran several examples and the results agree fairly well with the screw jack tables on the web. There is a worked example at the end of the paper for a 3/8-24 threaded rod. That is a shade bigger than the 8 mm threaded rods that several of you are using but still very similar.

In using this methodology please keep in mind that I make no claims for it's robustness. It has been nearly 40 years since I took dynamics in engineering school and there were several problems in derivations in the source paper that I was able to see that I tried to work around. It might give you an idea whether a stepper's lifting capacity is up to scratch in extreme cases like mine though. I always try to use a 100-250% safety factor when I design things.

If our blogs have any dynamics boffin readers I would appreciate any suggestions or criticisms of what I have cobbled together here.

One last thing, the header rather cheekily refers to the paper as "A Scientific Report". I make no such claims. That is an artifact of the Scientific Notebook template that I used when I put the paper together. I've not yet got sophisticated enough in using the text editing aspect of Scientific Notebook to figure out how to turn that header into something more appropriate.

RepRap at LCA2006

Monday, 30th January 2006 by Vik Olliver

I had the pleasure of attending LinuxConf Australasia 2006 last week, thanks to the University of Otago, New Zealand and the sponsorship of IBM and HP. I was there as a presenter of a submission on RepRap, which is now on our documentation page. I am pleased to announce that everything was a resounding success, to the point where the presentation was voted "Best Of" and I had to do it again!

Everything worked very well indeed after a bit of run-around trying to sort out clamp stands, hotplates, close-up cameras and so forth.

I have assembled the linear stage, and with the exception of the linkage (redesign in progress) it works well. I have reduced the component count to 42 components (every nut, bolt and washer) of which 5 are FDM'd and no component modification is required other than cutting to length. I need to taper a recess, add limit switch mountings, reduce the volume of plastic needed and then I'll try a Mk 2. The axes will stack to make an X-Y table. If Simon can get code to drive 2 steppers off one PIC, it'll make for a very tight little unit.

Fortunately Suz came to the conference shortly after me, armed with a box of goodies from the Stratasys. I Assembled the Mk 1 stage from the parts that night, with no modification needed that one couldn't do without a penknife. Here is the beast:

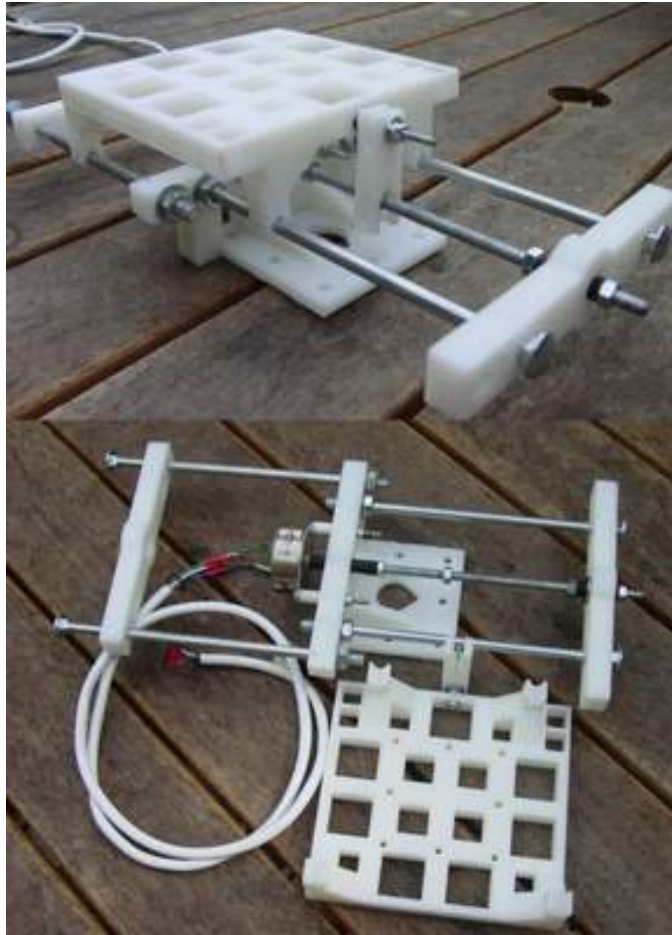

The star-shaped holes allow standard bolts to be used as accurate self-tappers (saving on nuts), and grip smooth shafts well. They should allow us to eliminate some of the clamps and their attendant nuts & bolts - also some of the more ungainly support material.

The presentation itself went flawlessly, with the TIP-based extruder extruding nicely in front of the close-up camera. For a Polymorph demo, I turned a hard Polymorph pancake into an amorphous mass, then into an apple-piercing dagger. Wood's metal was demonstrated by casting shapes in nothing stronger than filter paper.

After the presentation I was swamped by a rush of geeks, wielding cameras and wanting to know if it was OK to photograph the mechanism :) I actually ended up on national TV, but sadly the RepRap was not mentioned. Linux was a hard enough concept for the news team to get their heads around.

I spoke to MIT's Jim Gettys of the One Laptop Per Child project, who is sympathetic to our cause but has other problems to deal with right now. The good news for us is that he plans to release a "Hacker" version of the OLPC which comes without case and with access to built-in ports that the OLPC is not otherwise interested in.

I also spoke to Dr Wayne Piekarski from the the University of South Australia who is well-known for his work on virtual and augmented reality systems. Some of his students are developing a CAD/CAM system and would like to get hold of one of our extrusion heads for it. Wayne got a "Best Of" slot last year.

In all an extremely satisfying and totally knacker week.

Vik :v)

X-axis done...

Wednesday, 1st February 2006 by Forrest Higgs

After the NEMA 17 steppers arrived the obvious question was "now what do I do?" I spent a while doing a detailed design development of the last iteration of the Godzilla design.



I decided that I was going to make it of aluminum, which is, pound for pound, cheaper to use than steel. This would entail learning how to braze aluminum joints but that, technically, was not daunting. Doing the job seemed to be wanting to cost about US\$450-500 by the time all the parts were bought. Once those numbers were on the spreadsheet the whole exercise began to look vaguely ludicrous, never mind high risk.

While the Aol simulations revealed a lot of volumetric problems with putting the pieces together. It did nothing to reveal the sorts of problem that the pieces themselves might cause. Until I knew those sorts of answers the risk involved in going for an end product was simply too high to contemplate.

Instead, I've opted for a minimalist approach that borrows from Simon's RepStrap concept. For a working material I've chosen poplar wood. It comes in sizes that are very close to what I was using in the Aol design exercises. It is easy to work with inexpensive tools and, above all, it is so cheap that if I make a mistake I can just throw that bit away and not rue the expense especially.

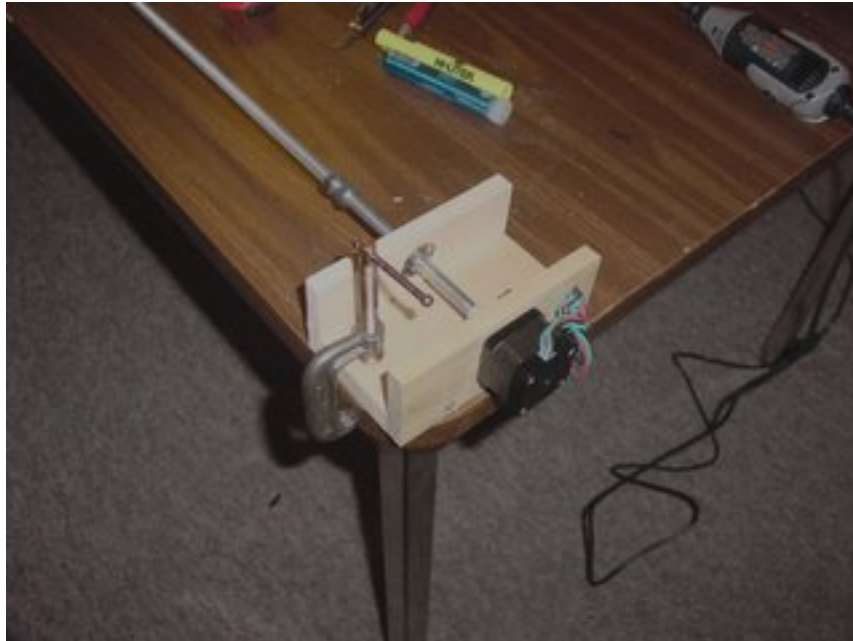

Godzilla depends on pairs of parallel power screws. I had web surfed enough companies doing precision positioning systems to know that parallel anything is a rather tricky condition to achieve. Because of that I opted to just c-clamp modules down to a relatively flat surface, viz, my work table. That got me to the next problem.

Threaded rods of the sort that you can buy from a hardware store are only sort of straight until you get up to diameters of 12 mm or so. At 3/8" inch (roughly 8 mm) you can get fine threads and a good price, but you also have troubles with straightness. Remembering an old Lindsay publication that showed how WWI-era British artisans hand straightened Enfield rifle barrels used the same tricks and got the two I had bought reasonably straight (about 1 mm play or less).

I drilled out a nylon sleeve to make the coupling mockup between the power screw and the stepper. It is already obvious that that is not going to be a satisfactory solution with a fixed mount stepper. You get just a bit of play and that will wear out the stepper bearings pretty quickly. I have got to either put the drive rod and stepper in orthogonally separate sliding mounts or create a drive coupling that damps out that kind of play.

The pair of x-axis screws will push and pull a derrick containing they and z axes back and forth across the table. The power screws will be attached to the derrick with sliding joints allowing for freedom of movement in the z-axis. Later I can cover the table with extremely flat float glass thick enough to not respond to unevennesses in the table. As it stands, though, the present rig will create a complex lateral movement profile in the y direction.

Obviously, if I had straight, stiff threaded rods I would not have a problem. Indeed, there is a little company that manufactures power screws situated about 150 km down the coast that will make me very straight power screws for US\$/20 per foot. That would solve the problem but break the budget yet again.

I could also supplement the x-axis stage with guide rods to take up the y-axis play. That begs the question of where one gets straight guide rods and at what price. I can go for diameter and add a lot of weight and cost, or go for tool steel drill rods and add cost... or I can see if the y-axis play is repeatable and can be mapped. My tendency is to go for mapping.

I had originally thought to map the system using a separate head that was the same as the extruder but with a microswitch on the extruder end. While Adrian recently suggested using some sort of lumpy standard, I thought that using a tilted piece of glass in the work space ought to give us the information we need.

Adrian recently put down the reliability of microswitches to guard the ends of the axes. I gathered by implication that some sort of optical sensor would be better. I wonder how we could sense contact or proximity to a calibration surface if we do not use a microswitch?

Replacing PTFE with concrete

Thursday, 2nd February 2006 by Vik Olliver

The PTFE rod used in the MK 2 Extruder design is a tricky item to come by. I've been wondering if it might be possible to create a replacement part from concrete. It's readily available, stable up to 290C and doesn't emit nasty fumes when overheated.

It's not very good under tension though, and needs to be kept moist during the curing process - small amounts of concrete are notoriously difficult to cure. I suspect a dampened, sturdy cardboard tube may be a good former.

Assembling the brass nozzle into a cement holder should be easy enough - either directly or by adding a couple of nuts to it so it can be removed for maintenance. End plugs left as an exercise to the diligent researcher (Polymorph, gaffer tape, whatever...)

I'm considering putting M3 thread or long bolts down the full length of the cylinder, and making the cylinder roughly 30mm in diameter, 60mm high. I'd be surprised if a 12W heater could warm the entire thing.

The protruding M3 thread would be useful in attaching the holder to the extrusion mechanism, dispensing with the current clamp entirely.

I also wonder if embedding fibreglass insulation would increase the strength of the concrete in tension? It wouldn't help with insulation obviously.

Another tack might be to embed perlite or vermiculite in the concrete to reduce its thermal conductivity.

I feel messy experimentation coming on...

Vik :v)

Moving right along...

Saturday, 4th February 2006 by Forrest Higgs

Once I decided to do the mockup of the prototype RepStrap in poplar wood instead of aluminum the pace of design development has picked up enormously. The poplar I am using is milled cabinet quality which means that with this fine grained a wood it has a dimensional accuracy of about a half mm. I'm giving it a shade less than 2 mm fit so that I can account for humidity changes in the wood. We are in the rainy season here, so I expect that the assemblies will shrink a little when it is over in late March.

As I mentioned last time, I had problems with the threaded rod not being quite straight. I sorted out 95% of that by straightening the rod, but finally decided that I needed some guideways to damp out as much of the wobble in the system as possible. Rather than going for steel rods I decided to just use more poplar. Oh yes, hereafter I am going to use Aol coordinate naming conventions.

Here is the z-axis with guide rails.



I have positioned them above the working surface {x-y} so that they can provide for stability not only against rotation around the z-axis, but also the x and y axes.

Here is the y-axis positioner.



Note the rails inhibiting rotation around the x-axis.

Now you can see the two integrated.



The y-axis slides back and forth in the z direction like a drawer.

What is not shown yet is the positioning collar for the y-axis that supports the x-axis positioning stage. I want the x-axis stage to fit around and slide down over the y-axis like a collar so that there is as little eccentric loading of the system as possible.

Of course, there are two z-y assemblies like this that support the x-axis stage between them like a beam. I will pin connect the x-axis stage to one of the y-stages and use a sliding joint for the other so that we do not transfer any torques from one of the z-y assemblies to the other.

So far the system is modular and pretty much demountable. I am currently working out how to

keep that demountability happening in the collar on the y-axis that supports the x-axis stage. I think I have a way, but I will have to purchase a few long bolts and wing nuts to make it happen. So it goes.

Here is the combined z-y axes stages with the bracket for supporting the x-axis stage in place.



The system is also scaleable. Using American parts and increasing the diameter of the threaded rod I can easily push the x-axis out to 1800 mm. Do., the z-axis. The y-axis stage is a little trickier, though.

Progress with cement

Sunday, 5th February 2006 by Vik Olliver

I've got a sample of cement curing now, with vermiculite added to improve insulation. I've also bored out another 50mm M6 brass bolt for use as a heater barrel. I'm making a 9 ohm heater element this time so we can reach higher temperatures. I fear we may pop a thermistor, but what the hey.

To insulate the barrel, I'm planning on using BBQ paint. This is a commonly available ceramic-filled paint based on high-temperature polyesters and is good up to 630C. The windings will be held down with plaster and fibreglass. There is a page on the Wiki covering the experimentation:

<http://reprapdoc.voodoo.co.nz/bin/view/Main/HighTemperatureMaterials>

Concrete and BBQ paint take some time to cure, however, so the results will take a few days to come through.

Vik :v)

Second z-y stage built

Monday, 6th February 2006 by Forrest Higgs

Making the second z-y stage only took about two hours. There was much less fumbling around this time. I'm tempted to make a third one and throw the first one away.



I may do that later on.

The y stage towers move easily with a touch of the finger. There was much less friction in the system than I had thought. Of course, the acid test will be when I load the x-axis onto those towers. I've calculated that loading to be no more than about 3 kg split two ways between the towers so it should not be terrible.

I did make one small mistake on the second one though. I took a centre measurement to be a top end measurement on the top bearing plate.



It will only take about 10 minutes to shift that upwards, but I'm not going to fix that tonight.



In the last pic I've mocked up the x-axis so that you can get a feel for the overall size of godzilla. It got considerably wider when I decided that it would be best to keep the x-axis threaded rod on the centre-line between the two towers. That meant that I had to handle the full 36" of the rod plus the connector plus the stepper. Oh well, I didn't really want to throw any dinner parties this year. :-)

I c-clamped the beams onto the towers and checked the resistance to movement. It's more substantial than before, but still no big strain from a purely qualitative standpoint.

First concrete test cylinder

Tuesday, 7th February 2006 by Vik Olliver

After 48hrs, the vermiculite/perlite/concrete cylinder had cured to the point where it could be handled and worked. It shed a lot of sand, but the overall integrity was good. It is mechanically not dissimilar to pumice, and a firm rub can easily dislodge surface material.

The concrete had a great many voids in it, and some of this may need removing. Perhaps a sander or similar vibration system could settle the concrete more thoroughly?

The screw embedded in the concrete comfortably supports a 12N load. A firm, steady pull just using fingers failed to dislodge the screw.

The central 3mm hole had rough sides, but was well-formed with little debris.

A 52mm I/D test article strengthened with fine zinc-plated steel wire awaits concrete pouring. I've fitted the heater barrel into the bottom of the mould by mounting it on a tin lid and taping it to the end. I need to make a couple of M3 anchors for it and we're ready to roll.

Right now it's dark and I'm tired. G'night.

Vik :v)

Godzilla is done for now...

Tuesday, 7th February 2006 by Forrest Higgs

I got to a stopping point after a 3 hour push this morning and another 3 hour push late this afternoon.



I was getting a bit punchy so I ran the movie Dogma for distraction for the last two hours of work. It suited my mood. Before that I had uninstalled Photoshop thinking it was Acrobat. Acrobat has been giving me fits for some reason.



The X-axis stage is a bit fiddly. I wanted to keep it relatively narrow and centered on the Y-axis

threaded rods(the y-axis threaded rods are also centred on the z-axis threaded rods). I've tried to reduce the eccentricity of loading to the bare minimum. When I do that I use less materials trying to brace against eccentric loads. As a result it is a bit hard to work with.



You can see a mockup of the stage on which I will be able to mount the Mk 2 extruder in the centre of the x-axis.

The usable working volume is measured now at 700x700x350 mm.

Now to build that PIC programmer board. :-)

Mk 2 parts arrive

Wednesday, 8th February 2006 by Forrest Higgs



I'd measured the Mk 2 from the photos half a dozen times. Until I held the parts in my hands I hadn't been able to get my head around the idea that this is a tiny thing. It's brilliant! :-)

String Wars

Thursday, 9th February 2006 by eD

Adrian and I had a bet. I reckoned that before I went boarding for a week, I could get my rig working to spec with string, and Adrian didn't €“ he thought I'd need a timing belt with teeth. And so began a dark time during my PhD where I (King of String) banged my head against many brick walls to win that elusive pint from the Chief of Teeth. Here's the rig I used, complete with the calliper to measure its performance:

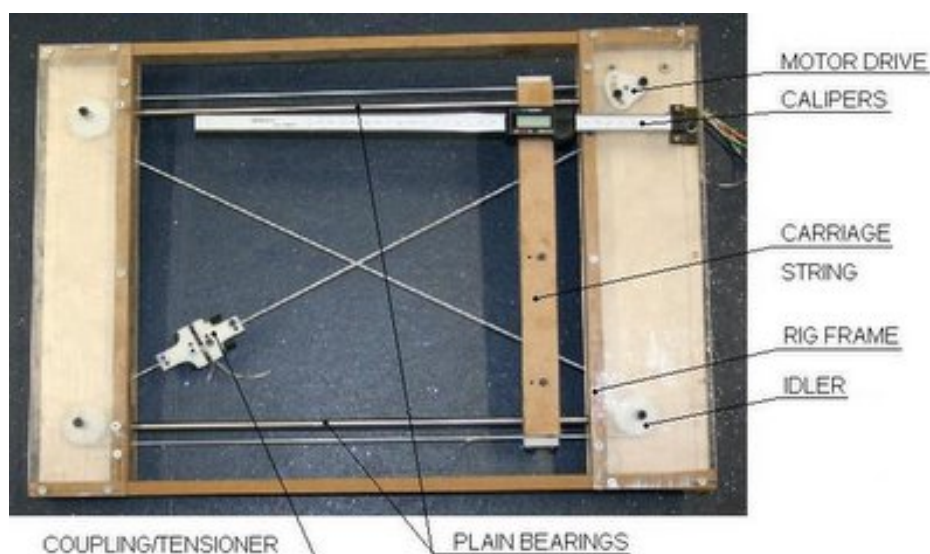

String, I quickly learned, is rubbish. It suffers from creep under the high pre-tension required for the rig to work. After doing lots of hunting [big thanks to previous inspired comments] I hit the jack pot with high tensile steel fishing wire coated with nylon. Cheap & accessible - ideal reparable.

A big problem with wire is its grip on the drive wheel grip. The figure below (left) shows the simplest drive wheel setup. Shrink wrap on the drive wheel certainly helped things, but with such thin transmission wire and a small (12 mm) drive wheel to achieve high resolution (specifically without gears) the total grip was naff all. I tried a pinch assembly to increase the contact angle but that wasn't enough either.

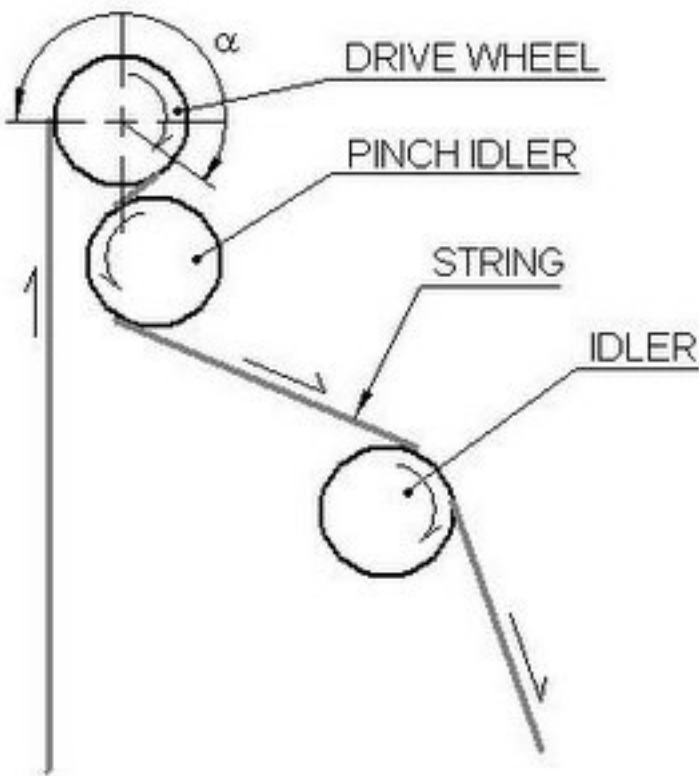
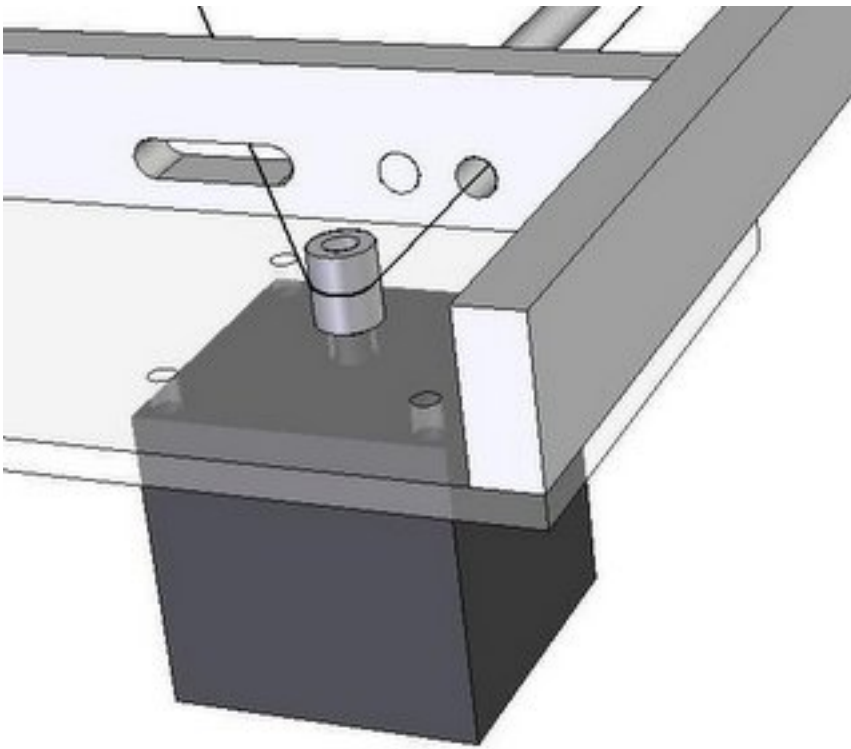

And so the wire was wrapped at least once around the drive wheel. It solved the grip problem, but because it was wrapped it followed the Archimedes screw principle and rode up and down the length of the wheel when it was turned: bad news for repeatability and accuracy I thought, not to mention messing up the tensions.

I tried everything I could to stop the wrap from riding, from shelves and curves on the drive wheel to constraint on the input & output. Absolutely nowt. The wrap will always ride. I went snowboarding, and reminisced about the pint I'll never have whilst being mocked by chairlifts which are mostly made out of wire, pulleys and drive wheels.

But I got back and thought "well lets let the wrap ride then". What are the accuracies and repeatabilities like? Answer: Good. For the 10cm distance I could test it seemed repeatable (triple wrapped on a plain shrink wrapped drive wheel). There's some mysterious jamming going on in my rig with an asymmetrical load (to be fixed with better bearing constraint), but when I put a timing belt on it, this made no difference and proved my wire's innocence.

The worry I have with the wrap unbalancing the tension is because as soon as it moves above or below the centre plane of the drive wheel it creates a larger hypotenuse = strain = increase in tension. See below...

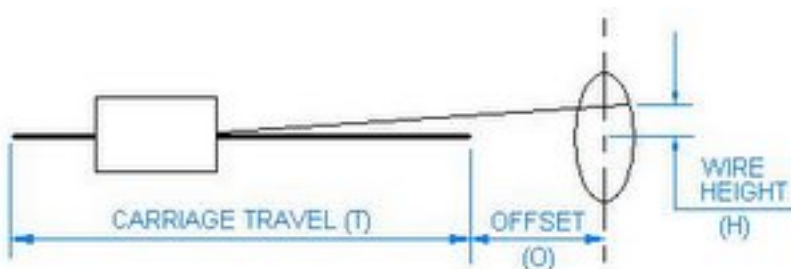

But I did some calcs & worked out an egg shaped profile for the drive wheel which would side step this problem. The graph below shows the dimensions of the profile which I think is doable (for an offset of 100 mm, pitch 0.5 mm & max carriage travel of 300 mm).

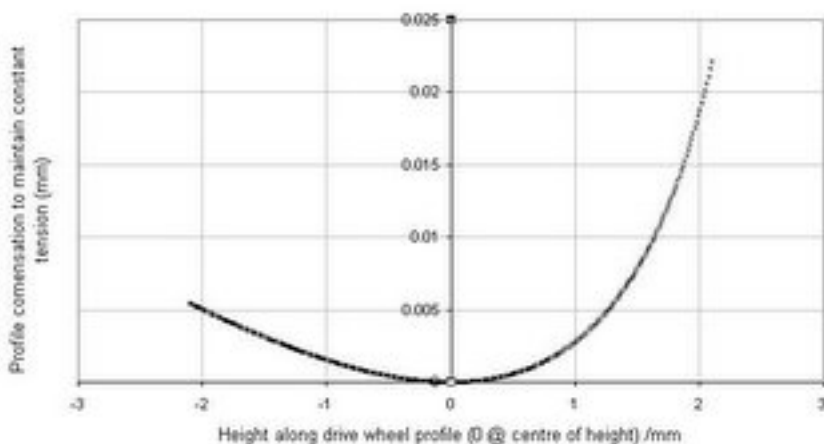

So Adrian will certainly get the pint, but wire is not yet dead: it is the rebel faction in my transmission war and although I'll be working with teeth for ARNIE Mk 1, I'll be thinking of string.

Building the JDM PIC Programmer Card...

Friday, 10th February 2006 by Forrest Higgs

It has been nearly twenty-five years since I built up a circuit board. I wasn't that good at it when I was doing it and the little I knew then I've obviously forgotten. I started out being very businesslike, making up parts lists and buying bits... all well and good.

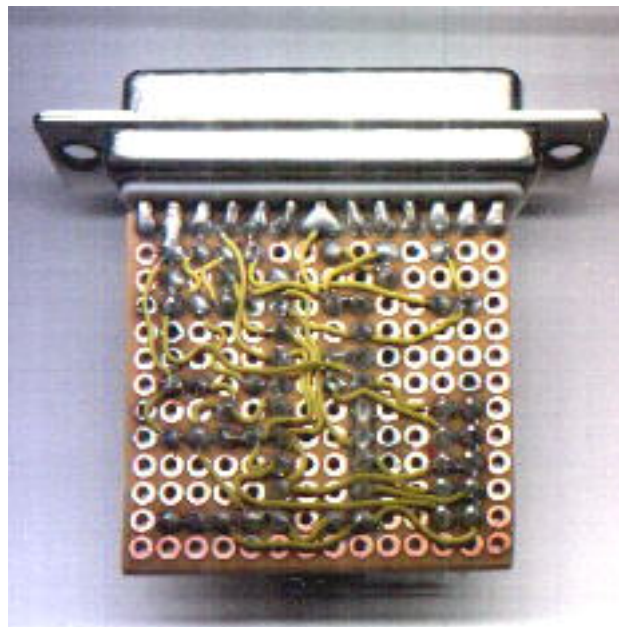
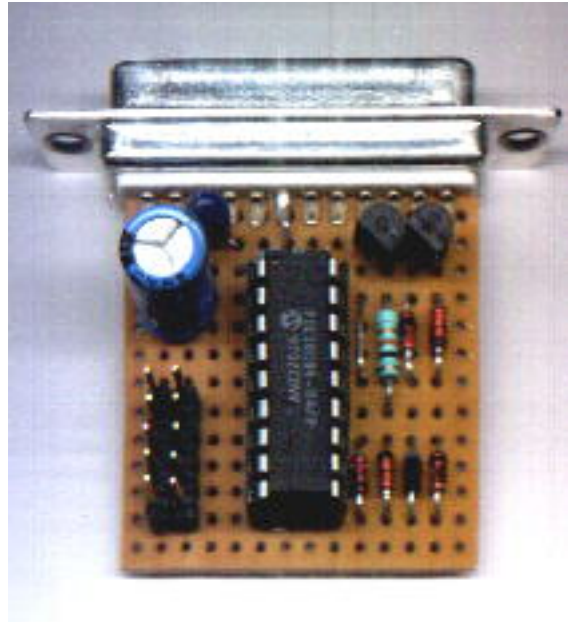

The first thing I remembered that I'd forgotten was how poor my fine motor control (neurological not stepper, mind) is. I remembered that when I started fiddling with the tiny little circuit boards that JDM had bought to put the parts to the board on. The mare's nest of wiring on the back side of the board should have been a tipoff, but no. I was still too green.

Fifteen minutes of trying to wrestle parts onto the 45x45 mm board the JDM used sent me back to

the supply shop for something more suitable. I conjured that I could just about work with a 115x160 mm board. Perhaps later I will be able to improve on that, but realistically I doubt it.

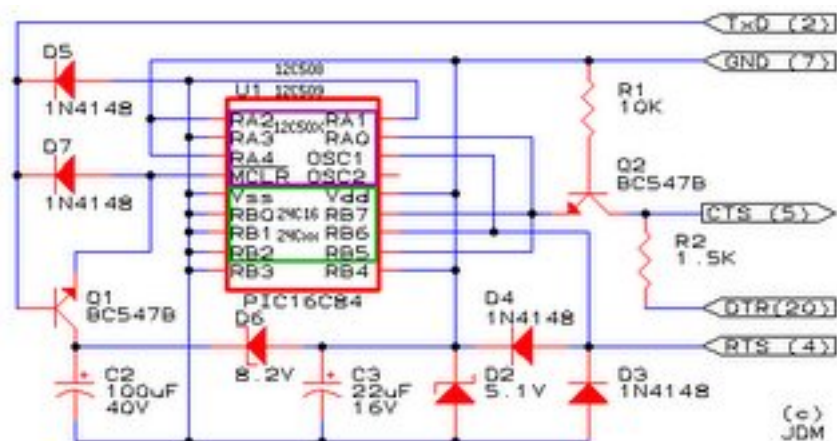

Next, I sat down and practiced my soldering technique tacking down the 18 pin socket for the 16F628 chip roughly in the middle of the board. I found that I still remembered how to solder, however poorly.

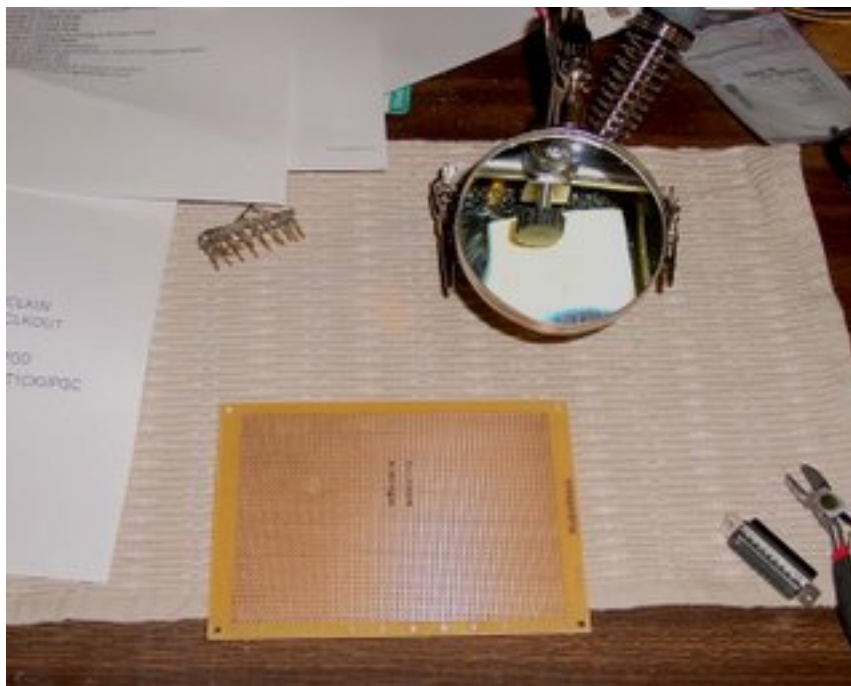

Once finished with that I grabbed a copy of JDM's circuit diagram and started to look at parts to put on the board. Then it hit me, is this circuit diagram looking from the top or bottom of the circuit board? What was the convention? I certainly couldn't remember. The circuit diagram is remarkably unhelpful. No notch mark... no pin 1 note... nothing. That U1 mark at the upper left of the 16F628 might mean pin 1, but it would be nasty to do the whole board and then realise that I had a mirror image of what I actually needed.

Digging around on the Microchip website I found a pic of the chip with the pinouts.

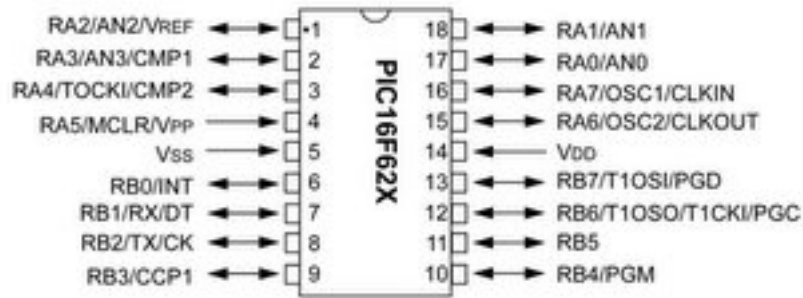

Yup, I was looking at the top of the board. I knew where I was at.

At that point I took the JDM schematic into Photoshop and did a horizontal flip on it so that I could see what the traces would look like from the back of the board.

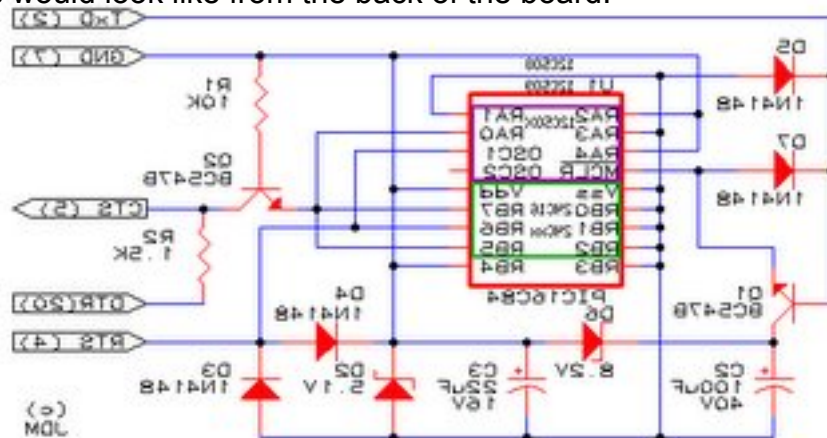

This must all seem rather ridiculous to you circuitry designer pundits on the team, but I am trying to put myself in the position of about a 14 year old tyro that wanted a Reprap to build action figures that he'd captured out of his favourite video game. Things had to be simple and conceptual leaps had to be very short indeed or we were going to lose such people. For a guy in the Third World, things were likely to be much worse than that. I've taken a few notes from the Gingery DIY books, which have some good ideas on presentation. Even those aren't as well thought-out as they need to be.

You circuit designers have probably already figured out where I am going with this. The component layout on the schematic and the component layout on the board are going to have a one-to-one correspondence. I don't think we can depend on our early adopters having the sorts of topological skills in mentally flipping circuit diagrams that a circuitry designer or even a hobbyist with a few years experience has. Even if all the pieces to a Reprap came in a box with subassemblies already put together this device is not going to be a trivial thing to assemble and get going. I feel that we need to be simpler than possible where ever we can. :-)

Concrete insulator Mk 1

Friday, 10th February 2006 by Vik Olliver

I've just taken the concrete insulator assembly out of the mould. Here's a view of what it came out looking like. Prognosis is good, and it is now drying off in a reasonably safe location with the heater barrel still in place. The concrete is quite dense due to the use of vibration to settle it, though there are still some bubbles visible:



RepRap

Friday, 10th February 2006 by Brett

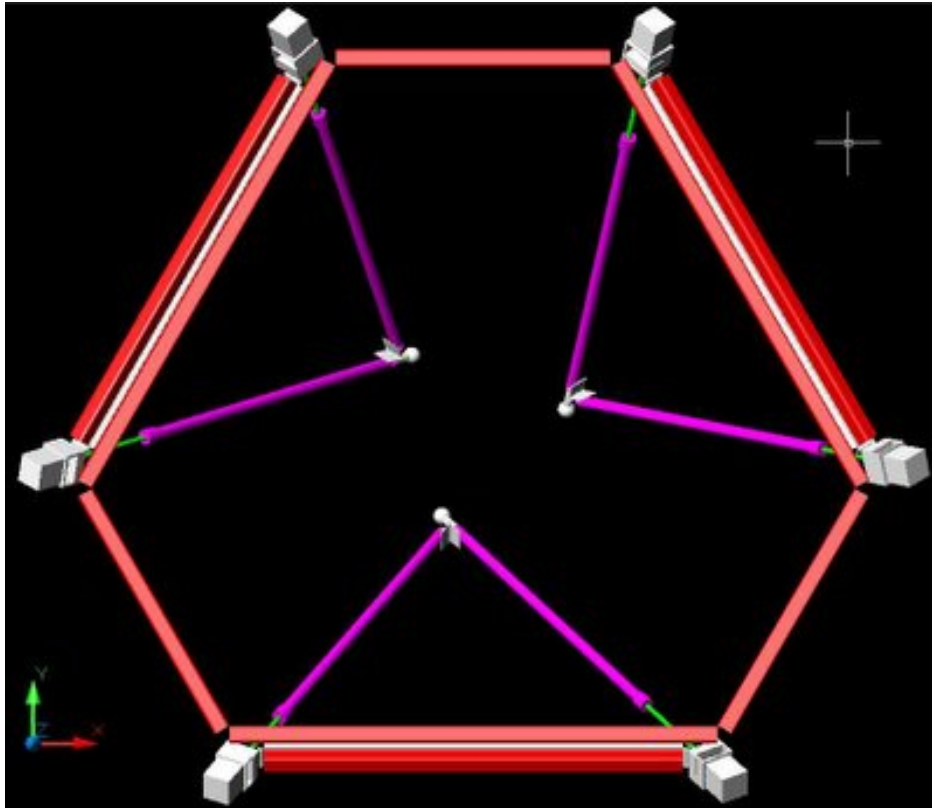

Stewart platform, first stab.

I will revisit this post when the design has been finalized, and try to clean it up a bit. But I felt I ought to make some effort to inform people where this stood.

For the uninitiated, a Stewart platform is a positioning device first used for flight simulators, and today used in some unusual milling machines. Essentially a space frame made of six adjustable length actuators, its chief virtues are mechanical simplicity, and high rigidity, because all the elements are loaded in tension or compression, rather than bending. A very minimalistic sort of mechanism, without high precision ways or guide rods.

Its chief vice is that control is highly complex and non-intuitive, as a given increment on one axis will produce wildly differing motions in different parts of the platform's range of motion.

Software is, as we all know, cheaper to reproduce than hardware. ;) Hence my belief that the Stewart platform is better suited to reppap than cartesian positioning systems.

My primary objective these last few days has been to design a really cheap, yet backlash free, linear actuator, which can be used in the construction of such a platform. The main components I have settled on are 8M1 threaded rod, and 1/4" schedule 40 steel pipe. I have determined that it is possible to press a standard bronze bushing into the end of such pipe, and tap it for 8M1 thread, producing a nut with much less friction and slop than one would obtain from a hardware store. Said nut can be retained nicely by simply screwing onto the end of the pipe a pipe cap which has had a clearance hole drilled in it.

It is a glad coincidence that the inline skatewheel bearings plaasjaapie pointed out to us have a bore of 8 mm, and an outside diameter of 22 mm, the same as the pilot on a NEMA 17 stepper motor, such as he has also brought to our attention. This will make maintaining concentricity between the stepper shaft and threaded rod comparatively simple even without precision machining.

The stepper shaft and threaded rod can be mated by the simple expedient of turning the end of the threaded rod down to the same diameter as the stepper shaft, give or take a fraction, and pressing them into opposite ends of a short piece of tubing. A technique I can claim no credit for, I saw it used in Battlebot drive trains.

Geometry

There are a number of variants on the Stewart platform. The one I have chosen as easiest to implement has the actuators paired up, forming three triangles, each of which has one vertex connected universally to the tool head. The advantages of this are that universal joints are minimized, and screw torque can be expediently dealt with. Note that there is no tool head in the illustration below; I have not yet modeled that part. I plan to finish up the design this Saturday.

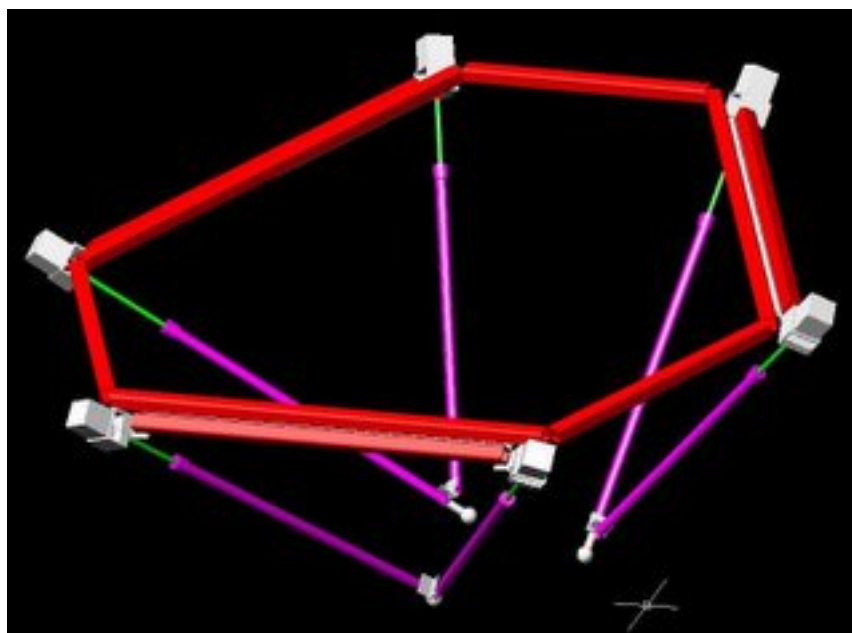

Because the actuators in a given pair remain co-planar, they can be connected to each other, and

to the fixed member between them, by simple hinge joints. Then that member can be connected to the common frame by another hinge. The only universal joints needed are between the common vertex of the actuator pair, and the tool head. It is my intent to use an industry standard tooling ball inserted into the end of one of the pipes, trapped within a tool head composed of a plastic sandwich, in order to form the universal joints. These are manufactured to high precision, and are available cheaply by mail order

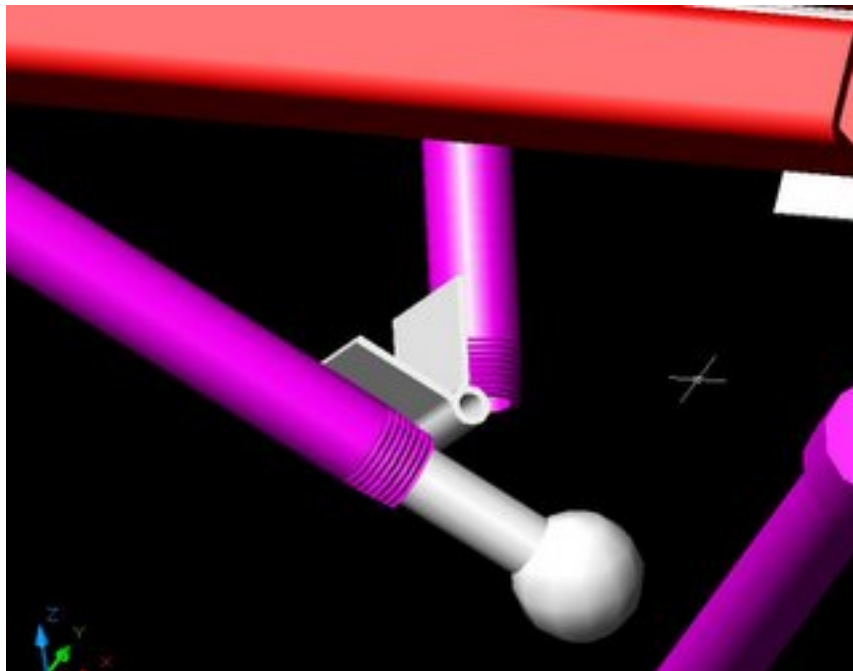
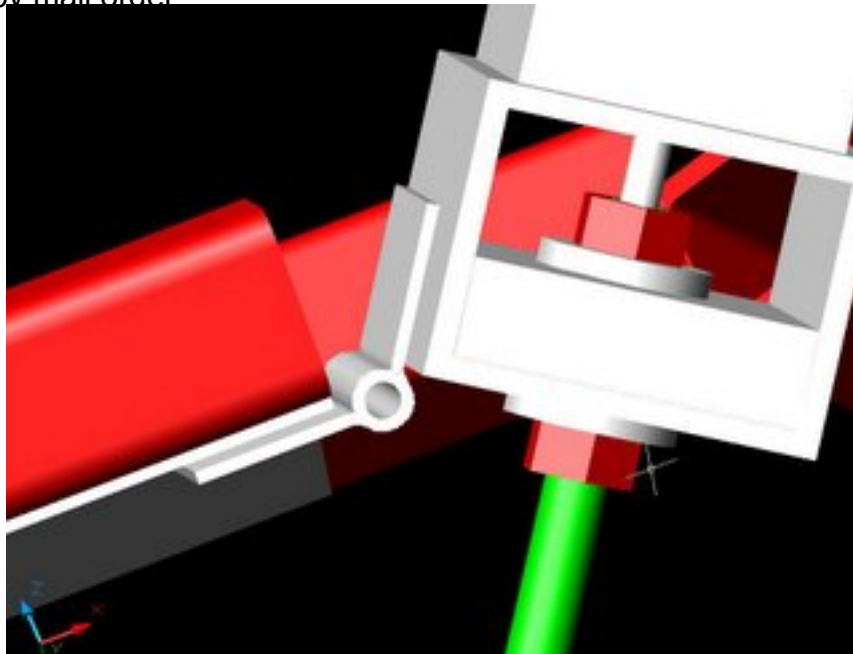

Calibration.

Calibration is a nightmare with this beast. Essentially, it will be necessary to include a CMM mode, during which the platform will feel various objects of known dimension, and derive from it's findings

a mathematical model of it's own geometry. Using math I haven't needed to call on since college a quarter century ago. ;)

Multiple functions.

Since the Stewart platform is inherently six axis, it ought to be possible to mount several mechanisms on the tool head, and bring each to bear in turn by tilting the head at different angles. Or if desired, to add materials to the sides of an object being built, instead of just it's top surface.

RepRap

PTFE-free extruder well plastered - and extruding

Saturday, 11th February 2006 by Vik Olliver

I've now wrapped the BBQ painted extruder heater barrel with nichrome, baked it with our roast to cure the paint, and wrapped it in a Plaster of Paris and fibreglass jacket. Tonight I might get to warm it up.

The concrete insulator is still getting greyer and lighter, which bodes well for its insulating properties.

It is undoubtedly harder to manufacture than the PTFE rod version, but uses only readily available materials.

+++ STOP PRESS +++

At the NZLUG meeting last night we hooked up the concrete extruder, set it to 150C and extruded Polymorph with it. It works!

Vik :v)

JDM Programmer Card done...

Saturday, 11th February 2006 by Forrest Higgs

Now I've got to buy some PIC 16F628 chips. :-o

Front Side

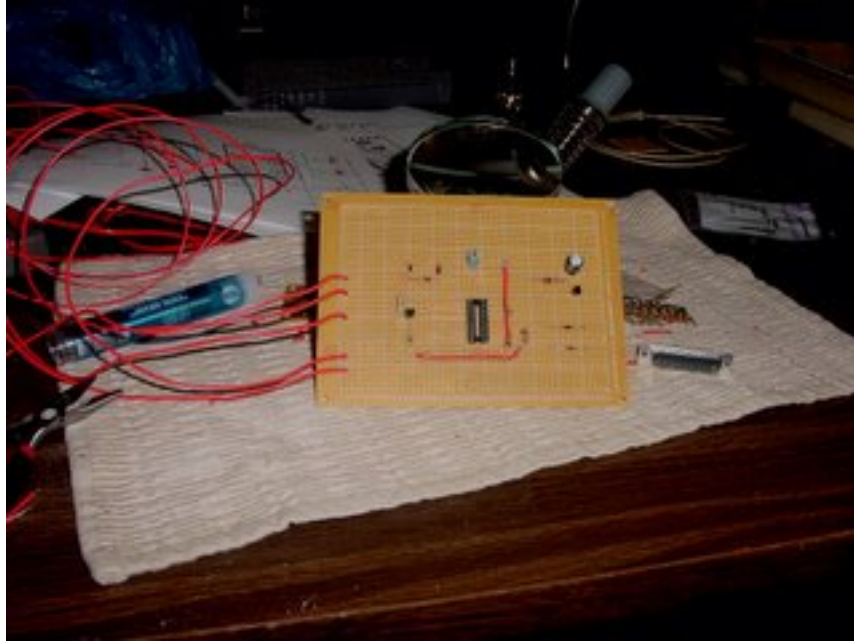

Back Side

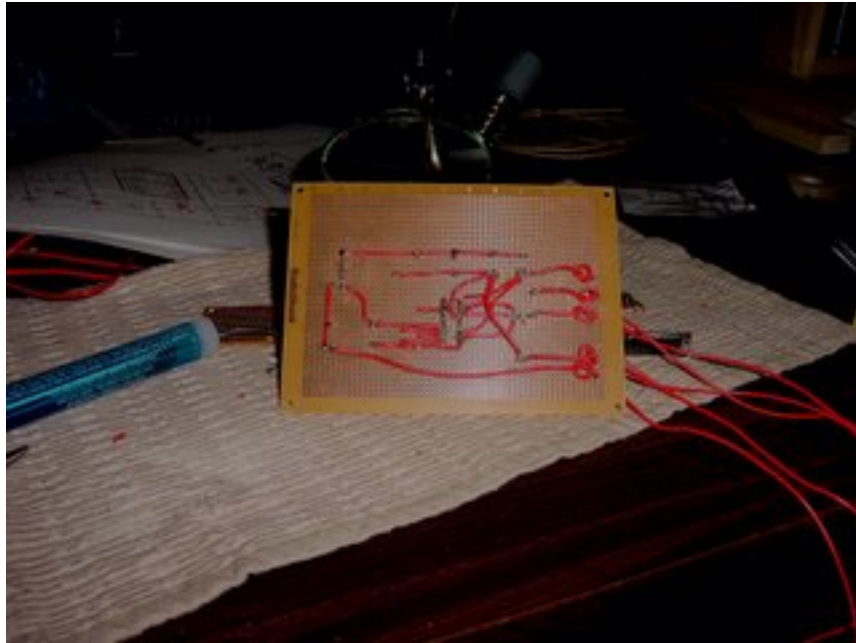

Cannon connector and cable built



The soldered joints are very strong. I think something might break if I dropped it and stepped on it. Now lets hope I didn't fry anything doing the soldering. :-o

Video of concrete extruder in operation

Thursday, 16th February 2006 by Vik Olliver

Last Moday I did a presentation to the Auckland Linux Users Group, and they have been kind enough to make a video of the presentation available (all 117M of it). Right at the end there is a video of the concrete extruder squirting Polymorph:

<http://aucklug.debian.co.nz/archive/files/aucklug-2006-02-RepRap.ogg>

I can also report that a new batch of FDM'd parts has arrived, and the linear axis no longer contains Meccano components. I've tested all but the vertical axis, which now has new clamps and so forth on it.

More to follow once I get my PC up and running properly.

Vik :v)

PC Death @ Vik

Thursday, 16th February 2006 by Vik Olliver

My trusty desktop just turned into a rusty desktop. Perhaps it has had a CPU-attack, having seen an older PC being eviscerated to form the body of a forge. Whatever, it now steadfastly refuses to boot off HD - so I'm running off an Ubuntu Live CD at the moment (a good trick if your PC is down). See <http://ubuntulinux.org>.

I'll try a reinstall using Ubuntu and see if I can't revive the PC. All files are being copied off onto the server, just in case...

Vik :v)

The next morning of filament extruder experimentation...

Friday, 17th February 2006 by Forrest Higgs

After realising that pumping water and pumping pellets or coarse powder polymer are apples and oranges, I cleaned out the test rig and decided to see if I could pump a coarse granular material instead. I spooned "cream of wheat" (semolina) into it while turning the screw shaft, in this case a wood auger, with pliers.

It pumped perfectly. :-)

Reprap Musings

Friday, 17th February 2006 by Zach Smith

Imagine a world where reprap has caught on, say 20XX. Substrate materials have become extremely common. Due to economies of scale, its dirt cheap. Infact, some people toss out broken projects, opting to print out a newer version instead.

Then, one could create a reprap project that was essentially a scavenger. It roams around, searching for consumables. It would gather enough material to make a copy of itself, then replicate. If done in the correct fashion, it would be an amazingly efficient recycling program. Mouse size robots scurrying around, searching for bits that can be recycled, then taking them back to home base. They could use accurate positioning and networking to pinpoint where sources of substrate are, then devour it, ant style.

Since you would only need a finite number of mice to cover a given area, there would undoubtedly be an overstock of workable material. Combine that with the robots being able to recycle most of their parts, it would be very self sustaining. Given the open nature of the project, it wouldn't be hard to imagine a benevolent individual offering free or low cost prints of reprap machines, or any other useful device. That would be very cool.

Obviously, there would be need to be certain guards in place. Ownership of resources would come into play, and also safety of the public. There are currently laws that cover these things. They carry serious punishment if you break them. If your mousebots eat some guys car, he will probably sue you. Likewise, if they eat the actual guy, you will definitely end up behind bars or worse. Even in the extreme event of someone releasing a intentionally malvolent replicating machine, there would be a hundred times as many normal, smart people out there who enjoy not being eaten or killed by robots and could come up with a way to disable it.

Initial experiments on filament extruder 2.0

Friday, 17th February 2006 by Forrest Higgs

Galacticroot over at CNC created a screw pump for wax that was my initial model for how to do things.



I built up a rig like the one that Galacticroot did. I used 1/4 inch ID fittings to do it which makes for a much cheaper and more dimunitive pump that Galacticroot had.



Metal bits

The first thing I tried was a 1/4 inch metal bit. I used my electric drill for power and initially tried to

pump water with it. You can see it and the barrel that housed it at the top of the picture. The first thing I noticed was that the metal bit pump would not self-prime. I primed the pump and ran it again. At that point I observed that the metal bit would not pump water under any circumstances. Indeed, it seemed to slow down the natural flow of water through the pump. Reversing the rotation of the bit made no difference save that a bit of water began to flow out of the pump at the end closest to the drill and the flow out of the extruder hole pretty much stopped.

At that point I decided that the fit of the drill in the barrel was too loose. I greased the barrel heavily with petroleum grease, reprimed the pump and tried again. There was no useful pumping being done. I observed a tiny bit of pumping in the reverse direction but nothing significant.

Having failed I went back to the literature. The first thing I noticed is that the diagrams I had showed the flight (thread) length on such drawings as I had pretty much identical to the gross diameter of the screw.

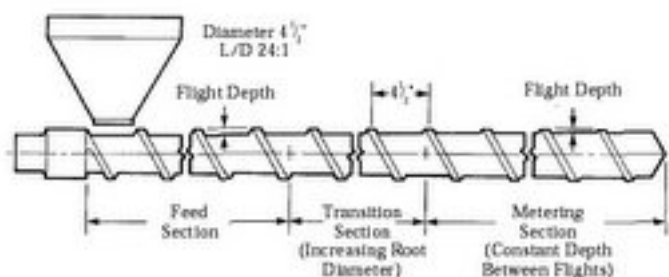

On our 1/4 inch metal drill the flight length was twice (1/2 inch) the diameter. As well, the proportional depth of the threads was much, much larger than what you encountered on a polymer pumping screw. Indeed, there was little core shaft as such in a metal drill.

Wood augers

Next, I tried a wood auger. The flight length of the wood auger was 3/8th inch for the 1/4 inch diameter as opposed to 1/2 inch found in the metal bit. The wood auger was also much longer with many more flights over its length. I acquired a longer barrel and rebuilt the pump. That configuration can be seen in the picture above.

I installed the wood auger, greased the assembly, primed the pump and began again. With the wood auger I got an appreciable pumping action, but nothing useful. Looking more closely at the wood auger it was easy to see that the depth of the flight was proportionally huge compared to a polymer pump screw. There was again almost no core to this auger.

Masonry bits

There are several types of masonry bits. Revisiting the local hardware store I encountered one

proportionally almost identical in form to a polymer pump. Sadly, it was 3/16ths inch rather than 1/4. All of the other masonry bits were simple twisted rods and apparently useless.

In the morning I will visit a much larger hardware store and see if I can acquire proper masonry bit to continue the experiments.

The Concrete Extruder and Full RepRap Axis

Assembly

Saturday, 18th February 2006 by Vik Olliver

Several of you have asked for still pictures of the concrete extruder, so here they are...



... and some new parts coaxed from the Stratasys by Ed have now enabled the completion of the long linear axis. The holder for the vertical axis now slides nicely up and down the rails, and the vertical axis - to my immense relief - fits in the gaps between the rails and the drive screw properly. The stage sits on top, and the extruder hangs down from above. 'Tis a wondrous sight.

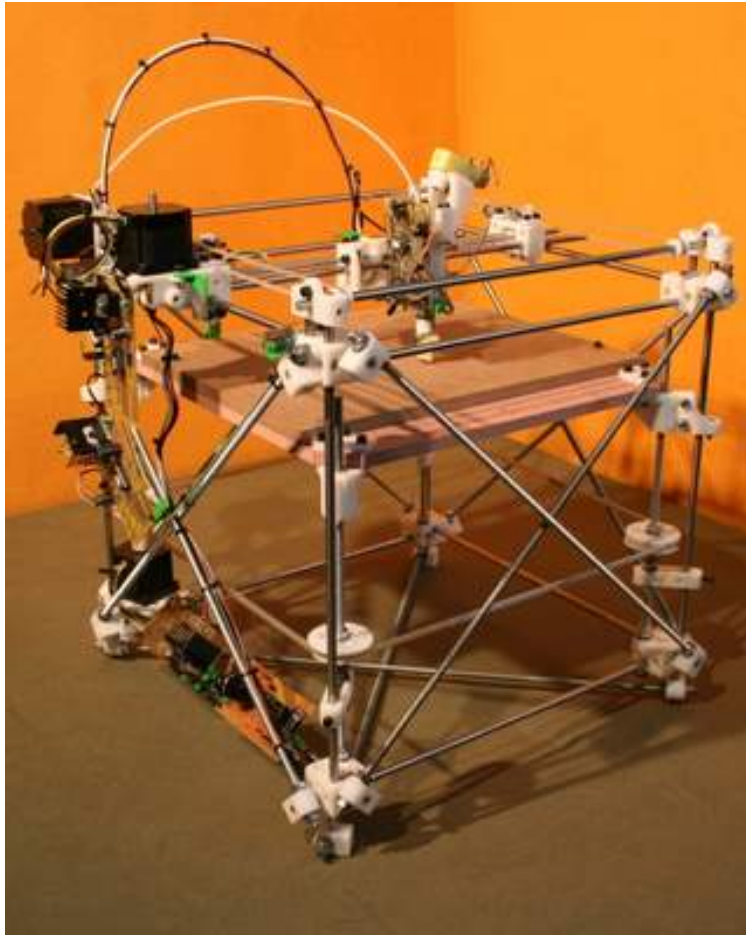

I believe I've pretty much got the hardware I need for a basic RepRap sorted out now. I've got to build 3 of Simon's stepper driver boards, and modify my extruder board but the major hardware work is pretty much done. Here is a picture of the entire X-Y-Z axis collection. All of them have been individually tested and work, but I have only one prototype stepper driver board at present. I want to keep that for basic unit testing, hence Simon's axis boards going into mass production.

I have to modify the stage slightly for Simon so that the new steppers from Forrest will fit properly. I underestimated their size slightly, so I'll have to add mounting lugs in a very ungainly manner. A good job not much torque is needed! Slight downer that I can't find time to play with all the new toys just yet :)

Oh, and my daughter Kate has built one of Simon's stripboard comms controllers with built-in 5V power supply, and it works properly (it's in the front right of the axis image). Now to build something real to get it to communicate with. Lo, I multitask. Kinda.

Vik :v)

Integrating electronics...

Sunday, 19th February 2006 by Forrest Higgs

I woke up this morning thinking that we didn't really have a problem integrating conductors with our polymer parts except that maybe we hadn't been thinking about it properly. I drilled down into our blog and discovered that Ed did the hard work for this nearly a year ago.

Now this may have been discussed one or more times before and if it has I've just reinvented somebody else's approach. Here goes, though. Risk-free thinking.

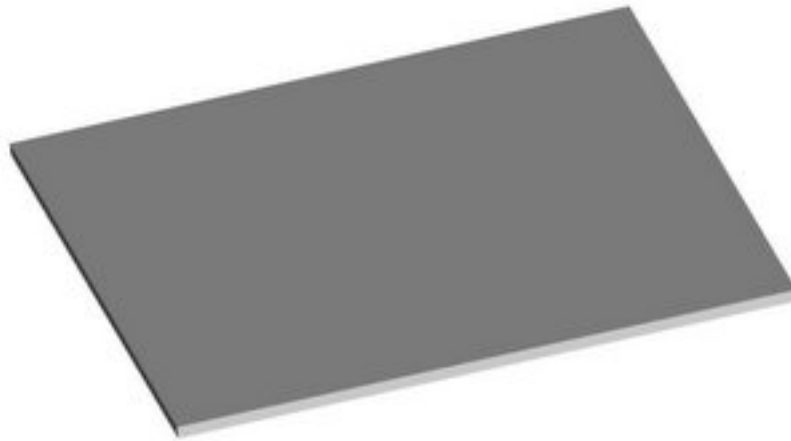

Put down a layer of polymer with your RepRap.

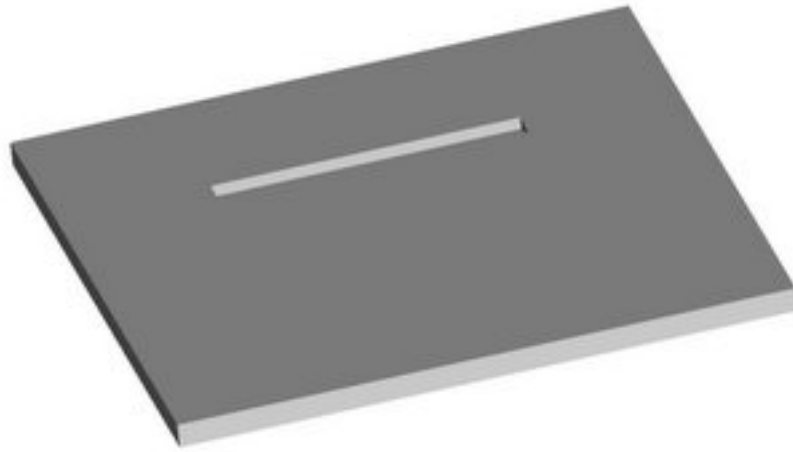

Now put down a new layer on top of it except where you want your conductor to be. Trade your Mk II extruder head for another Mk II that uses fusible eutectic filament for feedstock instead of polymer filament feedstock. Whether it's Wood's metal, Field's metal or any of half a dozen fusible eutetics is purely a matter of taste and local environmental regulations. Extrude your conducting eutectic into the slot in the second layer. Now here's the fun bit.

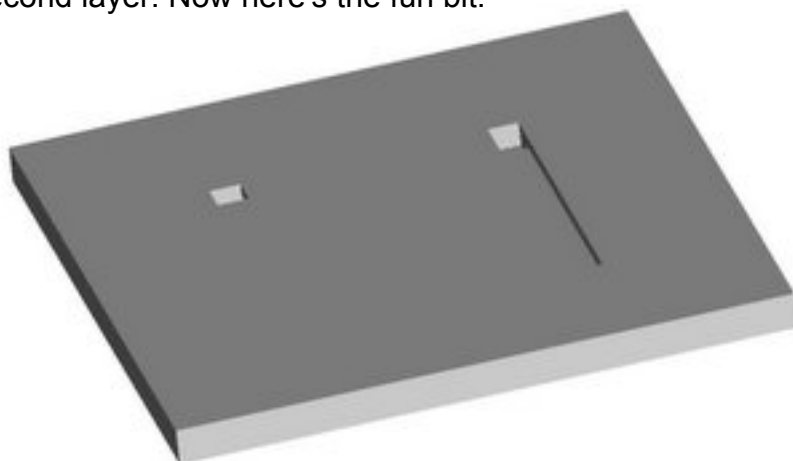

Trade back to your polymer extruding Mk II and extrude another layer of polymer on top of all that that leaves the tracks where you want the next layer of conductors to go. Notice that I've turned a corner with the conductor at the right and stubbed it on the left. Although the polymer will melt the conductor when you put it down over the conductor it will float on top since it is a LOT lighter than the conductor. Now trade Mk 2 heads again and fill the new gaps with fusible eutectic.

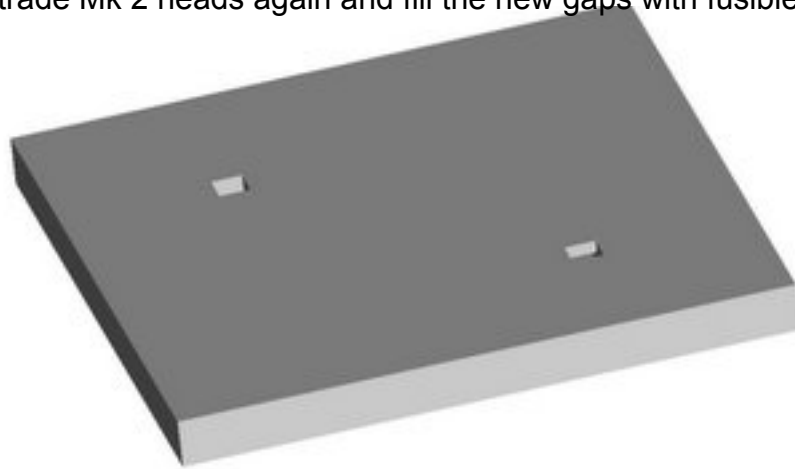

Trade back to your polymer extruding Mk II and extrude another layer of polymer on top of all that that leaves stubs for the two ends of your conductor. Swap over to your fusible eutectic Mk II and fill the stubs. Viola, you've got your conductor trace with the stub ends such that you can dip a soldering iron dialed down to it's lowest heating level into and stick in your components. Your conductor is completely protected by the polymer except where you need to attach components. Given a very high resolution Mk II extruding head this would be a natural for surface mount IC's

and components.

Indeed, later on we might think about incorporating the grab and place features of automated PCB board populators into a very sophisticated RepRap and have it fit the components onto the board as well. :-D

Guys, we could fabricate magnetic coils for motors this way.

Saturday afternoon filament extruder experiments

Sunday, 19th February 2006 by Forrest Higgs

I ran more experiments today using my 1/4th inch (6.35 mm) ID screw pump. I began with the metal drill bit that I hadn't used in yesterday's experiments.

Metal drill bit

Maple syrup

As you recall, water did not pump well at all in the rig. Adrian suggested that syrup should pump better than water. He was correct. Maple syrup did pump rather well in this configuration.

Semolina grains

I tested the configuration with uncooked semolina grains. The metal drill bit pumped that media wonderfully. I tried putting my fingertip over the end of the barrel. The semolina collected behind my finger and the drill bit was thrust back out of the rear of the barrel with considerable force. A very solid plug of semolina grains were packed in the barrel. I had to literally drill that plug out.

CAPA 6800 pellets.

I fed polymer pellets into the "t" junction. The metal drill bit tended to chop these up and pump them to the end of the barrel. Most, however, of the pellets were thrown back out of the hopper. The pellets that emerged from the barrel were mangled rather than chopped into proper bits.

Visual inspection indicated that the pellets were considerably larger than the helical passage in the metal drill bit. The pellets had to be deformed or chopped until they could be fitted into that passage.

Wood auger bit

I repeated the experiments with semolina grains and polymer pellets. The wood auger afforded a considerably larger passage than the metal drill bit did. Both semolina grains and polymer pellets were pumped effectively. The polymer pellets were not mangled as they had been with the metal drill bit.

Observations

Considerable torque forces are being developed when tough polymer pellets are being cut and mangled. Hanging on to the barrel with a spanner is not practical. A frame holding both the barrel and the drill is needed.

Vik's Presentation As A Stream

Monday, 20th February 2006 by Vik Olliver

Someone has put the presentation I did to the Auckland Linux User Group on the RepRap up as a stream off archive.org:

http://www.archive.org/details/AucklandLUG_RepRapProject_video

Vik :v)

The twist drill extruder

Tuesday, 21st February 2006 by Adrian Bowyer

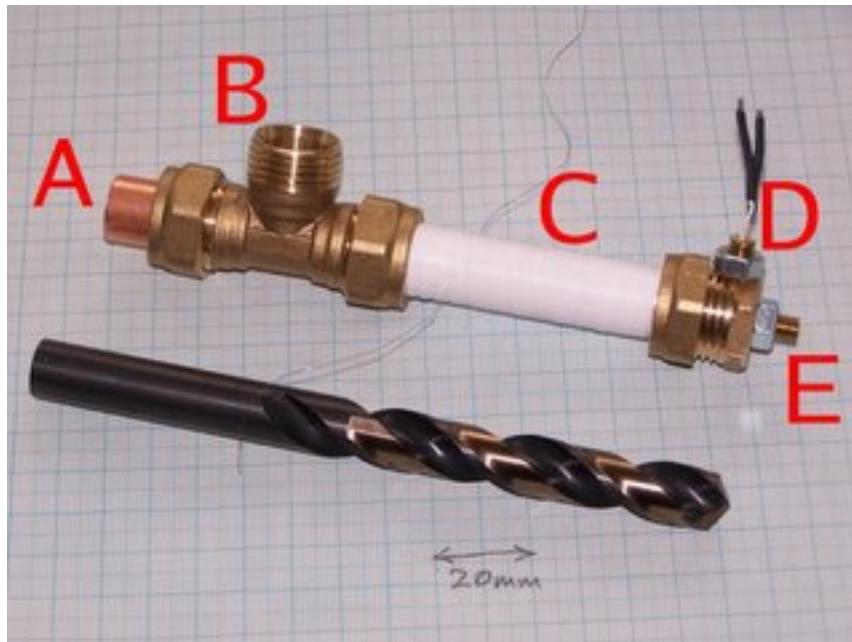

Here's an update on my implementation of Simon and Forrest's idea. It's made from standard 15mm copper and brass plumbing components. The drill bit fits down the middle, being inserted at A. It is rotated anti-clockwise to drag Polymorph in from the feed at B and to drive it into the heated barrel C. D is a thermistor plug for temperature control, and the extruder nozzle is at E.

The design would work with any national standard plumber's compression fittings; all that's needed is that the drill bit (13 mm in mine) is about 0.5mm under the inside diameter of the pipes. The heated barrel uses nichrome heater wire insulated with PTFE tape; that will get a lot simpler when Forrest's insulated nichrome arrives here in Bath.

The thermistor and nozzle can be swapped, and the end cap rotated by 180° . This allows the device to extrude axially or radially, whichever is required.

An obvious improvement would be to use a reduced-shank drill (which I couldn't get quickly) and add another blank plug with a hole for the drill shank at A. That would retain the drill bit nicely in the device against the force to the left from the pressure at the nozzle.

Experiments terminated now owing to a power outage! RepRappers deep in the Waitakere Rainforest who think themselves a little cut off may care to ponder that - in the country that invented electromagnetic induction, and but 30 kilometres from the remains of a civilisation that antedates the pyramids - the bloody electricity company can't keep pumping electrons down the wires in a reliable manner.

Watch this space when the juice resumes...

Pumping CAPA 6800 meal...

Tuesday, 21st February 2006 by Forrest Higgs

I ran the CAPA 6800 meal through the 6.35 mm polymer screw pump. Both the wood and the metal drill bits pumped the meal successfully. Interestingly, the metal bit had a smoother pumping action than the wood. That was probably because it has a closer fit with the pump barrel than the wood auger bit does.

I was able to rotate both wood and metal auger bits with my fingers, which means that the 200:1 gear motor that runs Mk II will run the pump. Whether it will develop the 40 atm head pressure required is another matter. Still, it's a positive sign. :-D

Grinding CAPA 6800

Tuesday, 21st February 2006 by Forrest Higgs

My sister's new quarter horse arrived unexpectedly from Wyoming this afternoon. The rancher that sold it to her had got angry with the transport company and decided to move half a dozen horses in the middle of winter himself instead. She got a call from his cell phone when he was crossing the Donner Pass in the Sierras. She called me shortly afterwards to ask me to bring around the company digital camera so that she could properly document her new acquisition. He's a beautiful four years old quarter horse that has been trained up as a working cattle horse. Even for a quarter horse he is unusually muscular and brings to mind more of a D-9 Caterpillar tractor than a horse. Still, he is gaited and has a very smooth ride.

While I was there I asked my brother-in-law if he remembered having an old meat grinder lying around. I recalled seeing one in his shop some time ago. As it happened he has about thirty meat grinders in a storage cabinet. My brother-in-law is an avid collector of antiques of all sorts. I brought home two, a very old Keystone and a not-so-old Universal #2 that looked rather like this.



It had a variety of cutting heads which I tried with CAPA 6800 before settling for the one shown in this picture that I found using Google Image search. I would have photographed it and the results of the grinding exercise except that the camera is currently being used on the new quarter horse.

My first mistake with it was to fill the hopper with CAPA 6800. Not! It could comfortably handle about 1-2 grams at a time. CAPA 6800 is incredibly tough. I ran the same 4 grams through about

twenty times before being happy with the result. An inclined screen to separate the fully milled polymer from that needing further processing would have been useful. As well a shield to keep a considerable amount of the original pellets from coming out of the cutting face like popcorn would have been useful as well.

The cutting head of the Universal #2 got quite warm even with the very low feed rate that I was using on it.

While I am going to be able to grind feed stock for the 6.35 mm polymer screw pump I don't think that hand grinding is going to be a practical way to prepare polymer for making into filament in the field. We can probably draft an electrical meat grinder into service for the task. Even so, though we are going to have to develop some sort of automated feed mechanism to avoid overloading it and have a vibrating screen as well to segregate the finished meal from polymer needing to be recycled into the grinder again. I suspect that we ought to be able to design something for this part of the system and RepRap it without a lot of trouble. The grinder and screw, however, will have to be steel.

Nuff Faff

Wednesday, 22nd February 2006 by eD

I put the admin to one side last week and designed the z-axis for ARNIE. Here's a picture of her (he's got gender issues) without the timing belt for clarity:

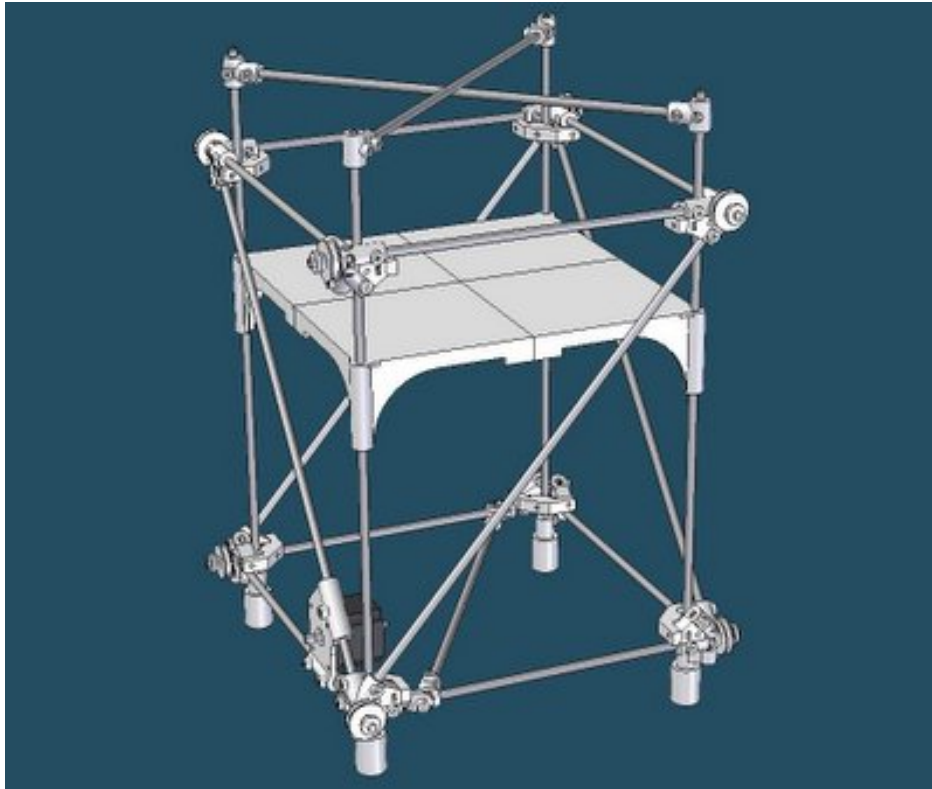

There's an idler at the end of each angle bracket which winds the timing belt around the frame in a series of N's. They link to the z-bed on the verticals (stays have yet to be added to the table). The X & Y will be added to the top once I've built the Z and am happy that she'll fly.

There's a fair bit of tweaking before I go for a build - the corner brackets will take 6 hours each so it's worth getting it right first time!

Grinding Frozen Polymorph

Thursday, 23rd February 2006 by Adrian Bowyer

I put about 20g of Polymorph granules (~3 mm in size) in my freezer (-20 C) to see if that would make it easier to grind. I discovered two things:

1. Polymorph is incredibly tough - the coffee grinder blades make the granules go round and round, but they don't break up, abrade, or indeed change in any way at all, and
2. If you put a whole coffee grinder in a freezer its shaft locks up when the lubricant freezes...

The twist drill extruder - initial experiments

Saturday, 25th February 2006 by Adrian Bowyer

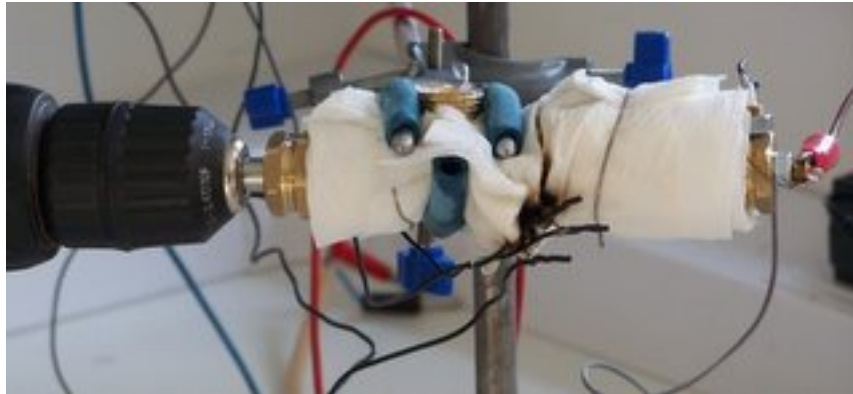

This is the twist drill extruder (just about) working. Here's a close-up of the polymorph extrudate:



Things I learned:

1. It needs a lot more power for heating. I had three 12 ohm nichrome wires being driven at 12v; i.e. about 36W. It took forever to warm up, eventually reaching a steady-state of about 120 °C. But it had to be insulated (or wrapped in paper kitchen towel... kids, if you want to burn down your

home, try this - the nichrome gets red-hot where it's in thin air, and sets fire to the paper; see the singed bit where the wires go in in the top picture.) I need to do a re-design heated by a cheap but chunky soldering iron; I think about 100W should do it.

2. The extruder nozzle is 2.5 mm in diameter. This gave an extrusion (with die swell) of 3.15 mm diameter, which is pretty close to what we need.

3. The extrudate has a few bubbles in; more alarmingly, it has pretty flakes of brass/copper swarf. When you turn the drill in air, it doesn't scrape off the sides at all because it's going anti-clockwise. But I suspect the much higher forces involved when the polymer is in there cause it to damage the copper and brass. Thought needed.

2559 Stepper board prototyped

Sunday, 26th February 2006 by Vik Olliver

Over the weekend I designed and built a UDN2559 (or UDK2559) stepper driver board, and a load of SVG stripboard objects for general use while I was at it. Simon is making a minor change in the general stepper driver board design to allow current limiting on over-spec'd motors, so it has those changes in it already. Once Simon OK's it, I'll put it up on the wiki for all together with the stripboard clip art.



Image not found.

NOTE: The board in the image above contains several wiring errors.

The UDN2559 driver will put out 700mA per channel and is a more current part (the ULN2803 being on last orders).

Adrian has the latest designs for the Stage Assembly, and when it all works I'll post one down to Simon for his tests - hopefully followed by a second one so he has a complete X-Y axis for software development.

Add to all that the imminent arrival of a donation of CAPA and nichrome samples from Forrest, and I'm going to have a busy week.

Vik :v)

I<>3RP

Monday, 27th February 2006 by eD

This is not news... but when I designed the trickiest most complex component I've done in a while...

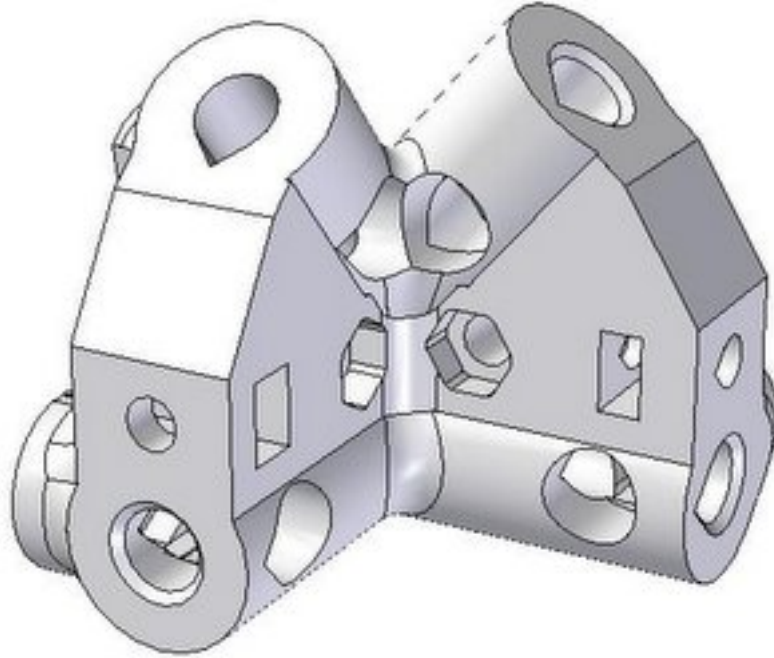

and then come back after the weekend to find EIGHT real life versions of them waiting for me in the bed of the RP machine...



... I think "think this is the best manufacturing technology in the world. Everybody should have

one." (Hang on, that kinda what we're...)

Charitable thoughts...

Tuesday, 28th February 2006 by Adrian Bowyer

A number of people have been very kind and made charitable donations to help us to run the RepRap project. A big thank-you to them.

There are currently seven researchers and developers working on the RepRap project. Two of them (Ed Sells and Adrian Bowyer) are being paid to do it, and have a research grant to buy materials. The remaining five people are working for nothing in their spare time, and - up until these donations started - were buying all the parts and materials they needed using their own cash.

Now you can help! To make a donation, click on this link:

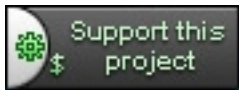

95% of what you donate will be spent entirely on parts and materials for those five volunteer developers. The remaining 5% goes to SourceForge to thank them.

Design study for the 6.35 mm filament extruder

Thursday, 2nd March 2006 by Forrest Higgs

I put in a few hours using Aol to see if I could make all the pieces for the quarter inch filament extruder work together. I'd like you to walk through the design with me and comment if you can see problems with it that I've missed. I put in a few hours using Aol to see if I could make all the pieces for the quarter inch filament extruder work together. I'd like you to walk through the design with me and comment if you can see problems with it that I've missed.



First, I'm using a quarter-inch diameter wood auger bit that is just over seven inches long. It has eight flights in the screw for a length of four inches, two inches of bushing behind that and a shank that extends for an inch and a quarter beyond that. I didn't take time to develop the screw portion of the bit on the left on Aol and placed a thrust bearing where the bushing meets the shank on the right. The thrust bearing is made of a drilled out 3/8ths or 1/2 inch bolt.

From my previous experiments I determined that the auger should extend slightly beyond the end of the pumping section to preclude polymer packing in the pump barrel.

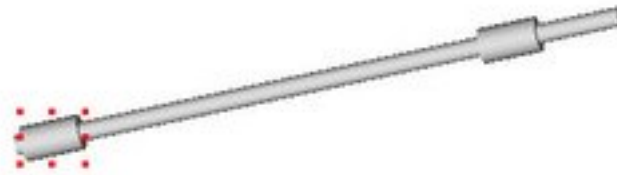

You can see the end of the auger extend just beyond the end of the connector plug that I've made from another one of those drilled bolts from which I've sawn off the head.

Now I include the body of the polymer pump.



You can also see the polymer feed into the top of the pump and the feed chamber where it intersects with the auger.

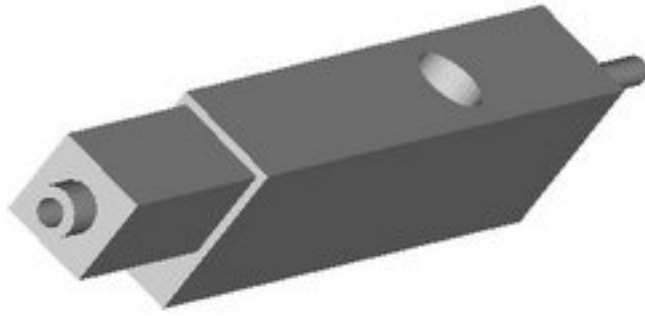

Next we screw the PTFE thermal barrier onto the connector plug. I've shown the PTFE bar, which has been drilled to a quarter inch to accommodate polymer flow and tapped at each end to accommodate the connector plugs, as slightly smaller in cross section than it is so that you can see where the steel polymer pump section and the PTFE thermal barrier join.

We can now screw the heated extruder barrel onto the second connector plug seated in the end of the PTFE thermal barrier.

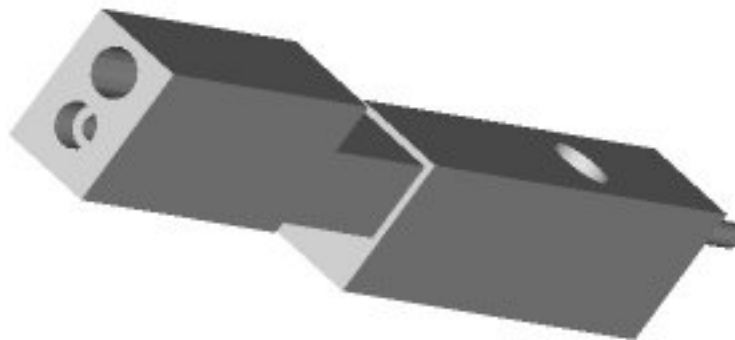

You can see that the heated barrel is drilled not only to allow passage of polymer as it is heated and is pumped towards the extruder tip but also to accommodate a 300 watt cartridge heater.

Now let us insert the cartridge heater.

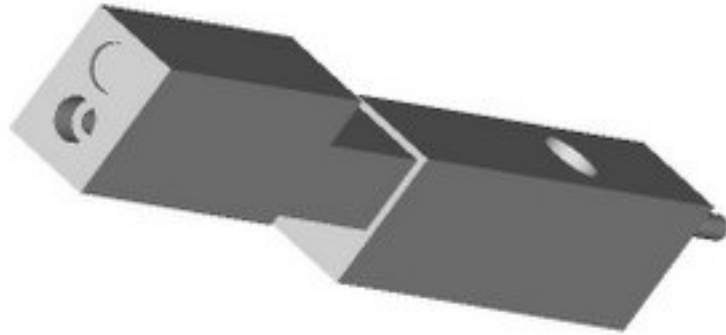

There is a quite inexpensive anti-lock compound that will prevent the cartridge heater from freezing up in its housing after a number of heating cycles. You will have to imagine the wires for the cartridge heater extending out the back of its housing towards the rear of the extruder. These cartridge heaters use regular lines electricity. You can also quite easily acquire bimetallic thermostats which can be used to control the temperature of the system. Like the cartridge heaters, these thermostats are very old technology and are also quite inexpensive.

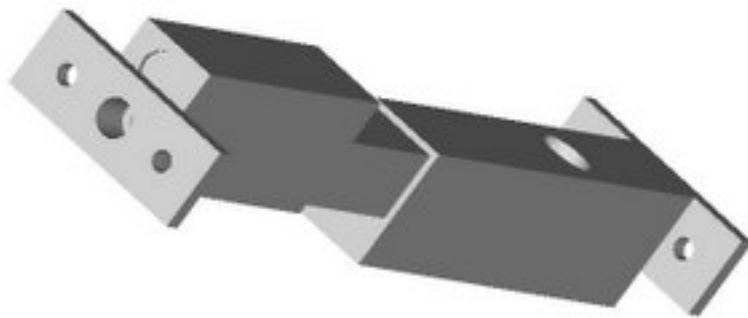

From this point we can apply the front and back retainer plates.

These are held in place by screwing the extruder tip into the heated extruder barrel on the front side and screwing the thrust bearing into the pump barrel on the back side of the assembly.

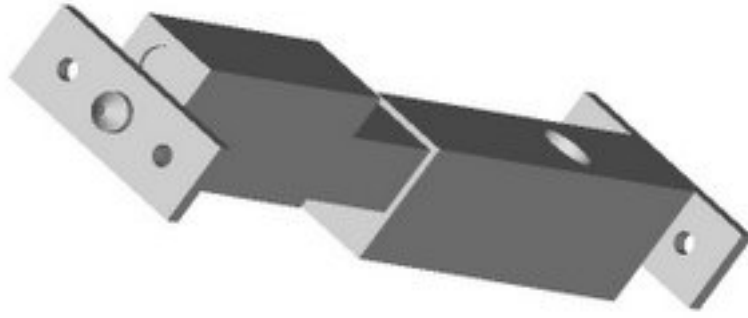

From there you secure the whole device with retaining rods made from threaded studding which are secured with lock nuts on both sides of the extruder.

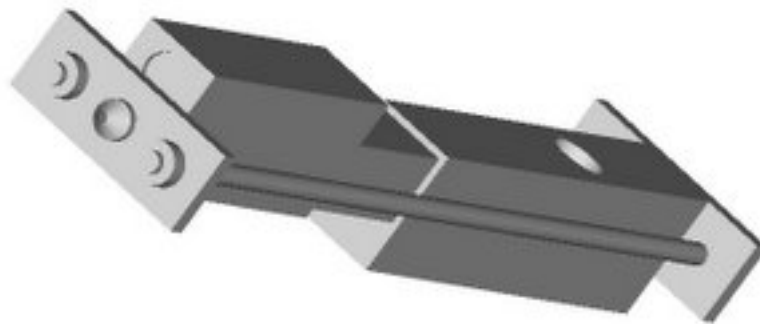

This arrangement hopefully will preclude the extruder from coming apart from the internal pressure of some 40 atmospheres created by the pumping action of the polymer pump. I've calculated that this pressure will create an axial thrust of about thirty pounds.

Once that is done you simply add the feed funnel for directing polymer powder resin into the polymer pump feed chamber and you should be good to go.

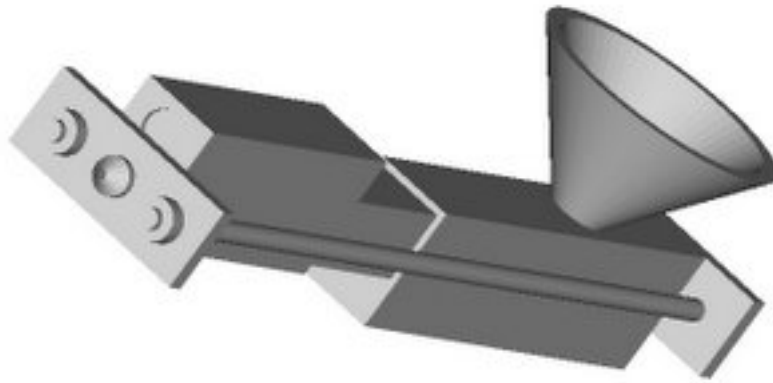

I am planning on taking the newly conservative approach that Adrian has taken of using an electric screwdriver to drive the system. I am guessing that since Adrian has already demonstrated that an electric screw driver will drive his 13.5 mm extruder it should be more than enough for my quarter inch device.

I was going to use the gear motor for the Mk II, but decided that there was too much drama in accomodating such a small piece of equipment into what is a rather large (about 1 foot long and weighing 5-10 lbs) piece of equipment.



Using an electric screwdriver will, I think, make the question of securing the system to a mounting block considerably easier.

I should also be able to run it without having to resort to complicated drive and control schemes. As for operating the system, I already own an infrared thermometer which will allow me to measure the surface temperature of the heated extruder barrel rather well. Initially, I plan to let the system heat up slowly whilst empty by adjusting the thermostat (which I will tap mount into the chin of the extruder barrel, not shown) until I get the temperature I want. At that point I will start the electric screwdriver and start feeding polymer into the system. The thermal capacity of the system is very much larger than the that of the polymer flow, so I doubt that the system will much notice the polymer being extruded from it energetically.

This design largely emerged as an effort to salvage some of the materials bought for the old Gingery extruder but not used. It was also designed with an eye towards being easy to break

down and clean in case of jams and allows for the performance of different polymers and also different diameter extruder tips to be surveyed. The cartridge heater is also magnitudes more robust than the hair-thin nichrome wire that we are currently using in the Mk II. Adrian noted that dipping his extruder head in hot water to get polymer out wouldn't be good for his device. I can demount the extruder barrel by loosening the retainer rods, slide the heater cartridge heater out, remove the retaining plate and extruder tip and immerse the extruder barrel into boiling water with no danger whatsoever. :-)

Now... objections... observations?

New RepRap Member

Friday, 3rd March 2006 by james low

Hi guys, my name is James and, as part of my final year mech eng project under the guidance of Adrian, for the next few months I will (try to) assist in the development of this revolutionary machine called RepRap!!! I will be working on a mechanical syringe for the deposition of a support material. Upon building a working prototype I will then look at a selection of "alternative" support structure materials such as icing sugar in order to find a cheaper or more convenient material for the everyday person who will be using such a machine in the future. So far I have concieved three ideas for the syringe design:

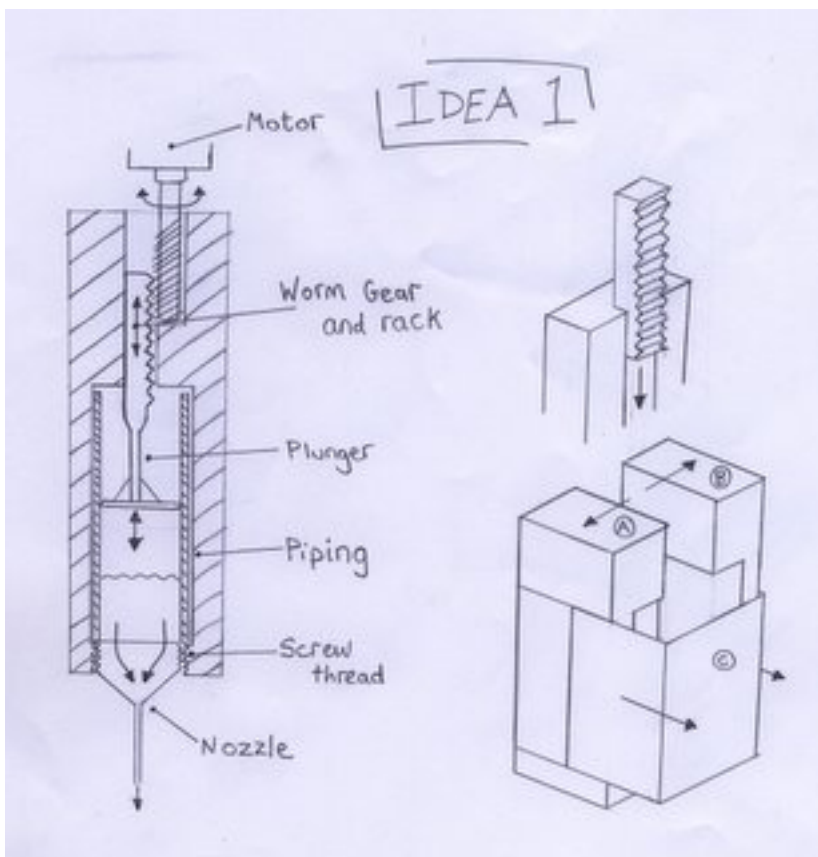

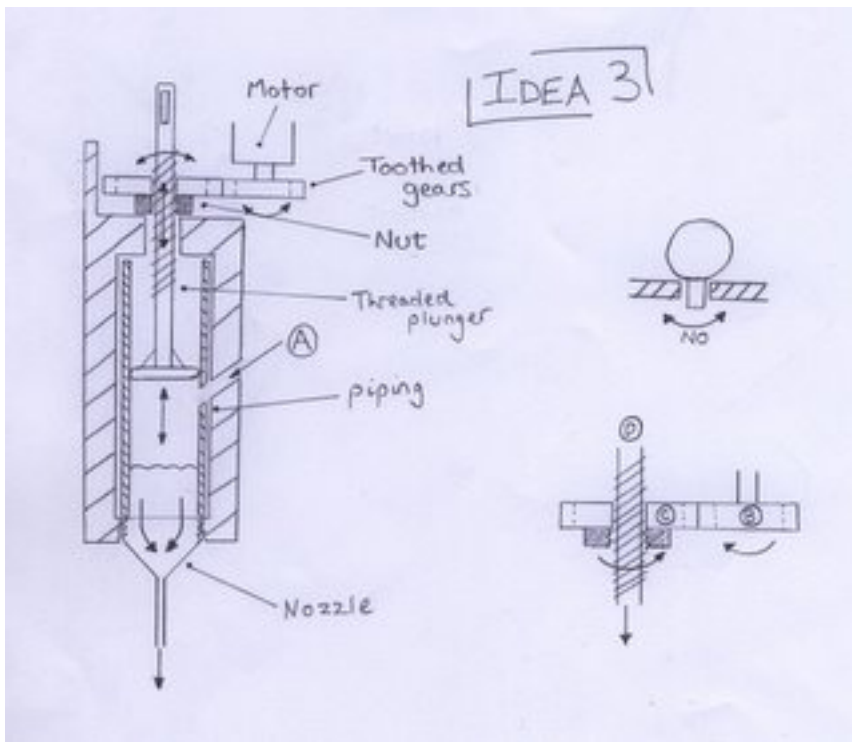
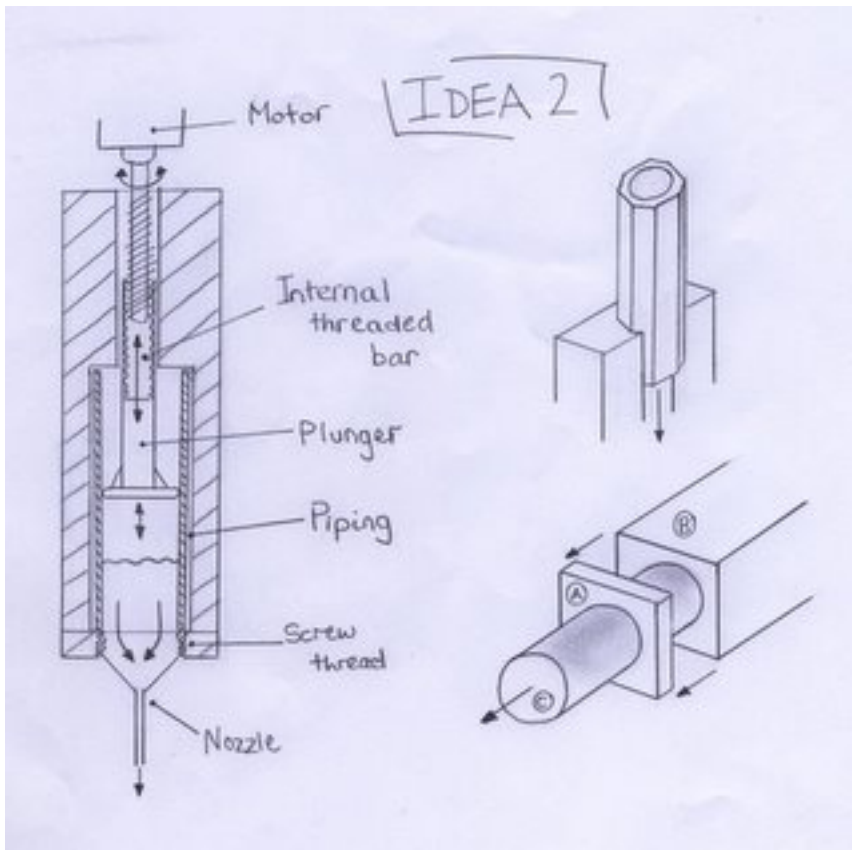

Of the three, I have decided to continue with idea 2 since it seemed the simplest and most reliable design. So now I have begun finalising the design, and will post an update when a prototype has been made and can be seen working.

UDN2559-based control board going

Friday, 3rd March 2006 by Vik Olliver

OK, I've got the resistors a factor of 10 out on the opto sensors on the first board, but I'm not using those anyway yet :) I'll fix that later. The main problem with the new board was a track cut in the wrong place - took a while to figure it out.

Now to modify the original board to use the new opto layout, and right resistor values. Then I should be able to control 2 motors. If that works I'll rearrange the bus to use the new power line arrangement Simon and Adrian figured out.

I've bought more stripboard, so hopefully I'll have 3 motors controlled soon.

It's still pretty beta so I'm not publishing yet. If anybody really wants the "how to" files though, mail me under caveat!

Vik :v)

Electronics from Kicad and laserprinted PCBs

Sunday, 5th March 2006 by Adrian Bowyer

I've been experimenting with the open-source Kicad electronic design system.

It's not too bad. After you get through the usual "How the *!\$*? do I do X?" stage at the start (the manual is OK, but - of course - manuals are for wimps...) you can create schematics quite quickly. Here is a small variation on Simon's extruder controller:



That took me about an hour once I got up to speed. Kicad's automatic PCB layout tools are almost useless, but its systems to assist manual layout are very good - they are clear, and don't allow you to make mistakes. Here's the PCB for the above circuit:

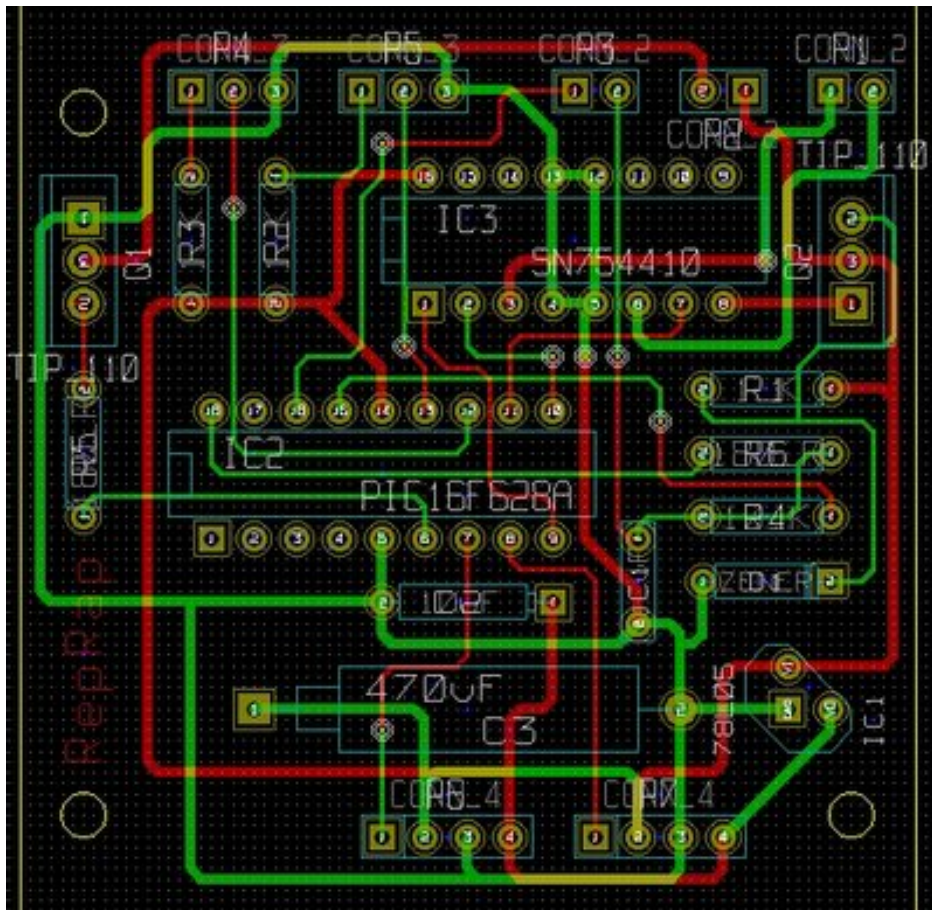

That took me about an hour too. (If you want to use Kicad install it somewhere where users will have write access to its libraries. You don't want to edit the layouts for existing chips etc., but the easiest way to add new ones is to copy and edit something similar.)

So next I decided to try to make the PCB using the laserprint-and-iron method. This wasn't such a success. I selected Kicad's high-res PCB plot option and created two postscript files, one for the reverse of the PCB and one for the obverse (component) side. The latter needs to be mirrored, of course. I then used an old HP Laserjet 6MP to print them. They came out very cleanly.

I cut the top edge of the paper on one to make them different sizes, then lined them up on a light box and taped them along the cut edge so they stayed in registration. You could probably do this almost as easily by holding them against a sunny window.

Then I cut a piece of blank double-sided PCB, cleaned it with wire wool and detergent, and taped it between the two prints.

I ironed the result on both sides. You have to take your time over this, apply plenty of heat, and be particularly thorough about the corners. The toner melts onto the PCB and sticks the paper down. You then drop it in warm soapy water and wait.

Here you need patience. If you try to rub the paper away from the toner stuck to the PCB too quickly it tears the pattern. Here's one, however, that I left for a whole day, which ought to be long enough. There are granules of polymorph in the bottom to give the soapy water access to both sides. I rubbed off the (now quite weak) paper. As you can see, the tracks still have gaps. I have tried a number of different papers, all with much the same result:

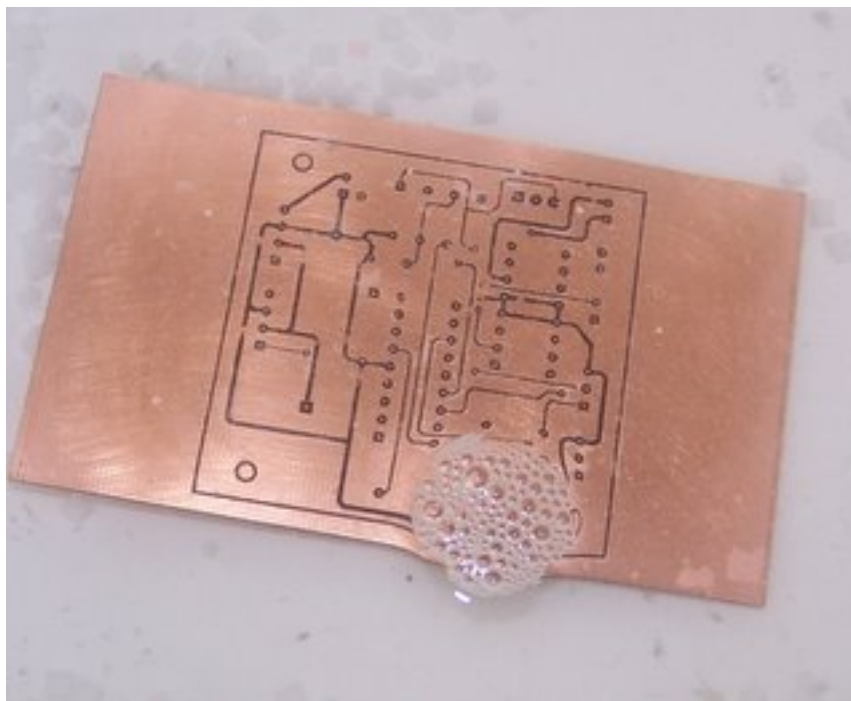

In order to avoid getting through square meters of PCB while conducting dud experiments, you need a way to clean the laser toner off. I found that 2-butanone (which I happened to have in my lab at home) worked well; this means that acetone would almost certainly do as well. Use both in a well-ventilated area, of course, and flirt but cautiously with naked flames...

Word on the web is that you need to use special water-soluble paper, which sounds reasonable. Here are a couple of suppliers:

DynaArt Designs
3535 Stillmeadow Lane
Lancaster, California 93536-6624
Phone: (805) 943-4746
FAX: (805) 943-3776

The Meadowlake Corporation
P.O. Box 497
Northport, NY 11768

I'll see if I can get some in the UK and experiment more.

More Google: other word is that the stuff to use is Press-n-peel. Opinion is divided: half the hits swear by it; the other half swear at it... I've ordered some; watch this space.

Monday tests on the 6.35 mm filament extruder

Monday, 6th March 2006 by Forrest Higgs

I decided to run a few preliminary tests on the 6.35 mm filament extruder before I did further work on it.

I used semolina as a proxy for polymer resin to check to see if the assembly would pump. There was no problem with that. I then inserted the PTFE thermal barrier into the assembly to see if I could pump semolina through that.

The semolina immediately jammed in the thermal barrier passage. It formed a 15 mm plug almost exactly like that I encountered when using the same auger bit in 1/4 inch steel pipe except the steel pipe only made a 5 mm plug before jamming.

The plug was easy enough to clear once I detached the thermal barrier from the polymer pump assembly.

Think that the problem might have been specific to the semolina I then used a few grams of the CAPA resin in powder form that I recently acquired as samples. The same thing happened. Any ideas?

Building the 6.35 mm filament extruder

Monday, 6th March 2006 by Forrest Higgs

The weather held this weekend so I was able to almost finish the 6.35 mm filament extruder prototype.



I am using Adrian's size convention in setting the calipers open to 20 mm for scale.

You can see that it bears a close resemblance to what my design study conception looked like.

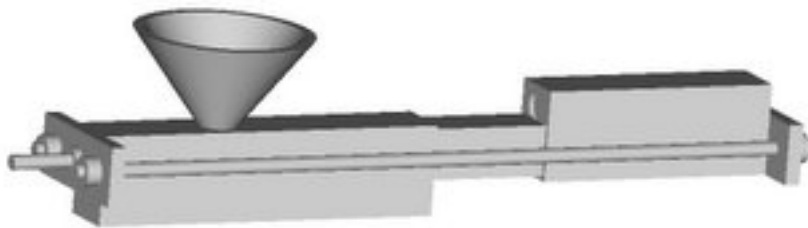

I oversized the PTFE sleeve in the thermal barrier so the design sags a bit right now. Following Brett's suggestion I will put a third support plate between the polymer pump and the PTFE thermal barrier to counteract any tendency towards buckling and more importantly, to provide a bit more support to the heavy steel extruder barrel to at the right hand side. That plate will support the retaining rods via PTFE sleeves so that heat moving down the retaining rods won't be transferred into the front of the polymer pump.

I had originally thought to use a 1 x 1 x 2 inch PTFE thermal barrier with two PTFE cylindrical plugs to connect it to the polymer pump at the left and the heated extruder barrel at the right. While I was building the extruder I realised that that would make four potential gaps in the polymer flow path between the pump and the extruder tip. I brought that down to two by drilling out a 1/2 inch cylinder of PTFE and then drilling a 1/2 inch hole in the 1 x 1 x 2 inch PTFE bar so that it acted as a sleeve for the cylinder. That worked quite nicely.



Here is a detail of the polymer pump. I got too tired to finish the thrust bushing for the auger bit so the auger is seen lying in the foreground of the pump. I am using an ordinary plastic funnel for a polymer feed hopper.

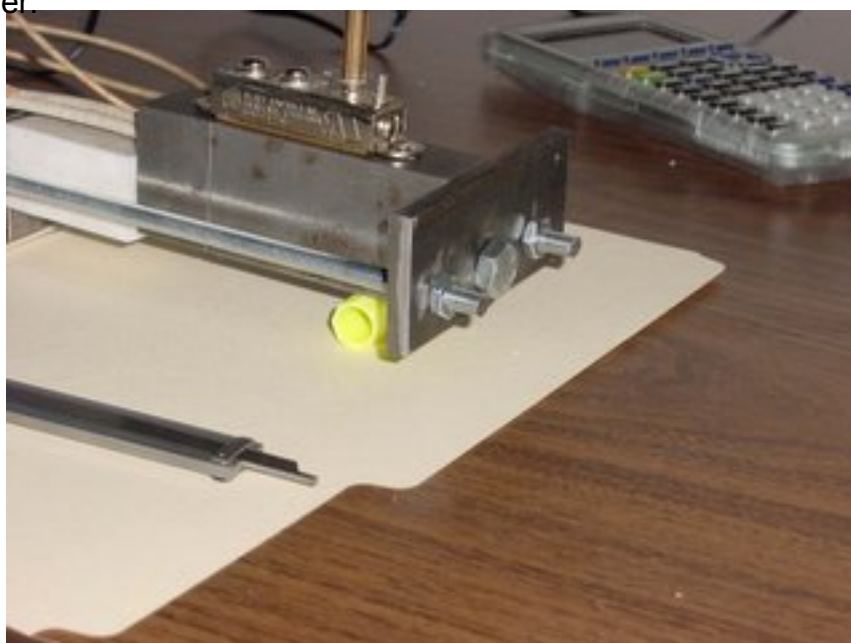

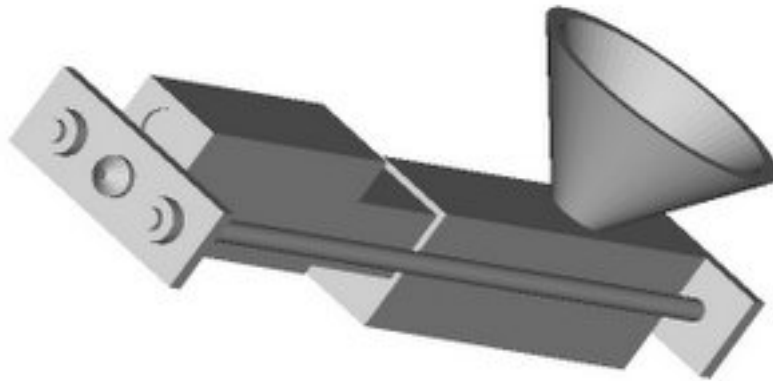

Finally, here is a detail of the extruder block and a mockup (3/8 -24 1/2 inch bolt) of the extruder tip. Again, I was too tired at the end of the day to attempt to drill out an extruder tip. I've done trial runs on both the extruder tip and the thrust bushing, both made from 3/8 inch bolts and found that to be very finicky work. I've got a handful of the bolts so I can afford a lot of errors. :-)

You can see the wires from the cartridge heater in the photo and also the thermostat sitting atop the heated extrusion barrel.

I have to tap in the thermostat and lock the extruder down on a block. I also have to mate the shank of the auger bit with the electric screwdriver you've seen in the pictures. That all will take another morning, I expect.

It's going to be another two-tylenol night. Right now I am for some supper, a shot of MacAllan 12 year old, a movie, a hot bubble bath and a good sleep. It's supposed to begin to storm in about an hour. We've got another pineapple express storm that's come up from Hawai'i this evening.

Tests on the 6.35 mm filament extruder

Tuesday, 7th March 2006 by Forrest Higgs

After reviewing Vik and Brett's comments, I decided to see if I could pump polymer through a PTFE barrel with an auger bit. It turns out that contrary to what I'd read, viz, that the wall's friction coefficient had to be higher than the auger's isn't so. CAPA pumped through a drilled length of PTFE with no trouble at all. That means that the whole pump and thermal break assembly could be made out of a single piece of PTFE.

There are two practical problems with doing that, though. First, PTFE is expensive at US\$0.15/cm³ (US\$2.50/in³). That wouldn't be so bad if I weren't worried that you'd be replacing it regularly because of wear between the auger and the barrel walls.

Vik makes another, more intriguing suggestion though. What if we applied a water jacket to the pumping section. My mind immediately went back to the old water cooled Browning heavy machine guns my grandfather used in WWI. I seem to remember that they worked by allowing the water to boil off. That would create a liming problem, but those are relatively easy to sort out.

Hmmm.... Adrian! How is that prototype of yours going?

20:22 PDT AKA 04:22 ZULU TIME 7 March...

Hit the hardware store again and had to choose between two German bits. One was half again longer than I needed and was made of some mad alloy of titanium and vanadium. I figured that I'd never be able to cut the carbide tip off of it, never mind mill the shank end down a bit to accomodate a thrust bushing.

I settled for a more modest German masonry bit that will require that I shorten the thermal barrier just a touch so that the tip end of it will extend into the melt chamber. I sawed off the end of that one and tested it with the pump barrel housing and thermal barrier and it happily pumps CAPA and even pumps it in the PTFE barrel. I suspect that it would have pushed the polymer completely out of the extra 25 mm of PTFE barrel beyond the end of the bit and out of the existing PTFE thermal barrier except that I was having to resist the thrust of the drill bit manually.

While I was at the hardware stockist I got the bits of power cord and taps necessary to seat the thermostat on the extruder barrel and get the melt going. I also bought a vise so that I can try drilling extruder tips here rather than having to trek out to my sister and brother-in-laws every time I need to put something in a vise.

22:35 PDT AKA 06:35 ZULU TIME 7 March...

Successfully pumped polymer through the polymer pump, through the PTFE connecting barrel and

into the heated extruder chamber with the new, longer masonry bit. Set up to drill a better aligned PTFE connecting barrel in situ and marked it. Drilling awaits a more godly hour.

0623 PDT AKA 14:23 ZULU TIME 7 March...

Managed to get a true hole through a PTFE cylinder on the second try. Double checking the polymer pump test when the batteries on the electric screwdriver ran down.



Time to make some breakfast. :-P

07:05 PDT AKA 15:05 ZULU TIME 7 March...

Repeated polymer pump test with recharged batteries. Interestingly, this time the pump filled the entire heated extruder barrel, 89 mm long and .89 cm³ volume, before jamming. The additional flights provided by the masonry bit apparently makes for a more efficient pump for the amount of torque that we have. Will be drilling an extruder tip and wiring the heater barrel after breakfast. Hope to run a full test this morning.

09:43 PDT AKA 17:43 ZULU TIME 7 March...

Thermostat and power cables rigged correctly. No fires, electrocutions or explosions so far. Have my fire extinguisher on hand just in case. :-o

Presently running tests to get a rough idea where the thermostat setpoints are. This takes time

because of the thermal mass of the heater block. Taking temperature readings in the extruder mouths with the IR non-contact thermometer. The mass of the steel will predominate with this system so I don't have to run it loaded with polymer since the heater barrel weighs a couple of pounds and a full charge of polymer in the barrel less than a gram. :-)



Temperature in the barrel is at about 60 Celsius just now and the thermostat setting is at 12:00.

10:16 PDT AKA 18:16 ZULU TIME 7 March...

Thermostat setting of 12:00 stabilises at 127 Celsius. Shifted thermostat to 09:00.

10:30 PDT AKA 18:30 ZULU TIME 7 March...

Thermostat setting of 09:00 stabilises at 94 Celsius. Shifted thermostat to 11:00. The indicator knob on that bad boy gets HOT!

10:58 PDT AKA 18:58 ZULU TIME 7 March...

Thermostat setting of 11:00 stabilises at 116 Celsius. It looks like the thermostat is pretty linear, which is what I'd hoped for. Now, I wonder what the deadband looks like.

Adrian got a bit of extrusion going at 120 Celsius, but Solvay took their melt flow index at 160, so I'd better check to see what higher settings on the thermostat gets me. The data sheets that Jeff's

people in the UK so kindly sent along with the powder samples indicates that CAPA decomposes at 200 Celsius. Fortunately, there are no halogens or nitrogen in the formula for CAPA so if I screw up and burn some it's unlikely to kill me immediately.

Oh well, now to get some food and drill a extruder tip. :-)

13:30 PDT AKA 21:30 ZULU TIME 7 March...

Thermostat setting of 15:00 stabilises at 132 Celsius. I'm going to crank the thermostat up to max, about 17:00 and see what happens.

By the way, the deadband is about 5 degrees. Not bad. :-)

13:50 PDT AKA 21:50 ZULU TIME 7 March...

Thermostat setting of 17:00 (max setting) stabilises at 160 Celsius. How convenient! :-D

Looks like I'm going to have to develop a graph for the thermostat performance. That certainly isn't linear. I also need to go back and check 15:00 again.

14:15 PDT AKA 22:15 ZULU TIME 7 March...

Thermostat setting of 15:00 (max setting) stabilises at 137 Celsius. Looks like last time I caught it at the bottom of the dead band. Ok, fair enough. :-)

So far so good! :-)

Wednesday morning tests...

Wednesday, 8th March 2006 by Forrest Higgs

07:45 PDT AKA 16:45 ZULU TIME 8 March...

This morning I did another test run of the extruder, this time with the barrel temperature set to 110. I taped down a lot of things and installed a funnel so that the feed of polymer into the pump would require less attention.

Before I powered up I noticed that the auger bit was frozen from having its tip embedded in solidified polymer in the extruder barrel. I turned on the cartridge heater as usual but this time with the extruder barrel full instead of empty. After a few minutes thermal expansion of the melting polymer forced a bit of filament out of the extruder tip before the electric screwdriver was turned on.

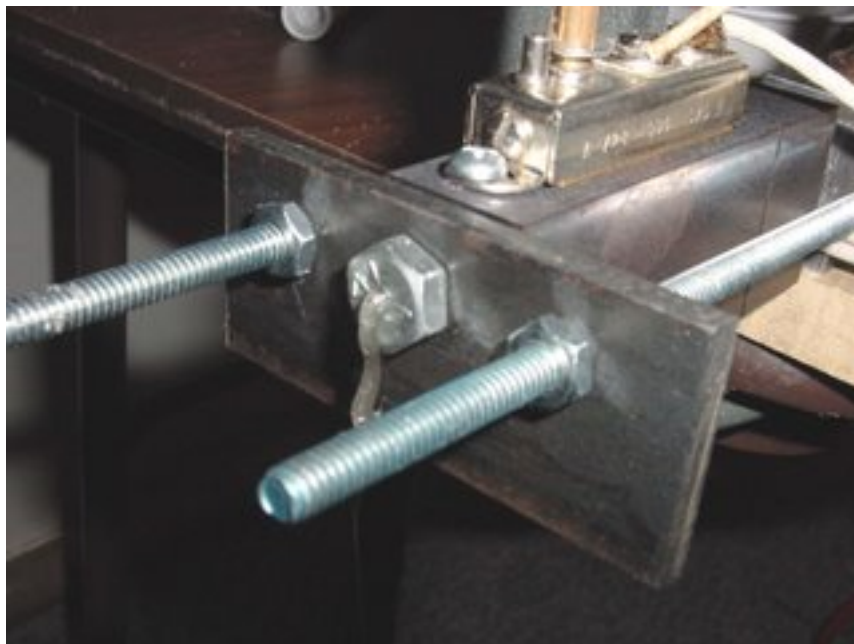

I tapped the on-button for the screwdriver and discovered that it rotated freely now.

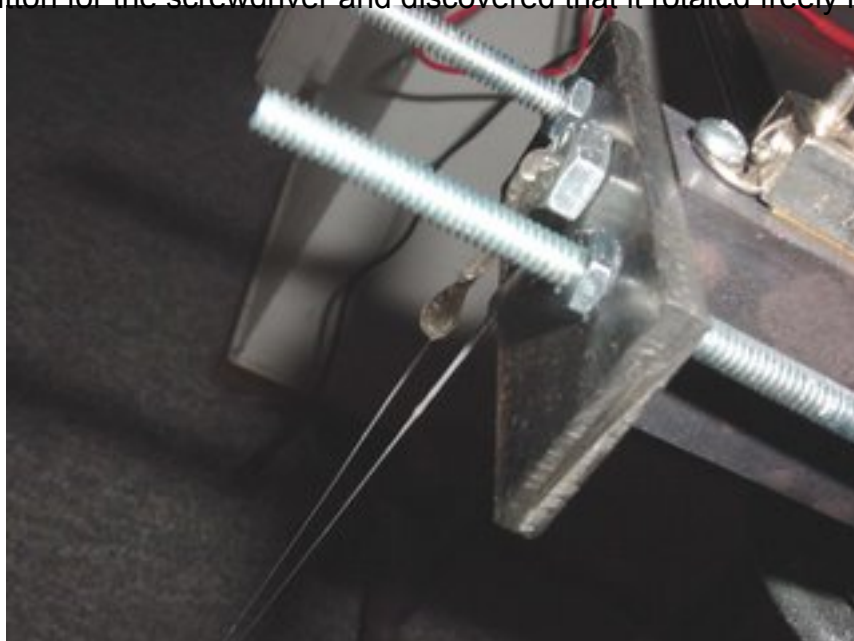

At 110 Celsius the extrusion rate was considerably slower, but the filament tended to hold its shape better. The axial thrust on the auger bit seemed to be considerably stronger, too. The emerging filament still tends to foul on the extruder tip and thread as the length of the filament increases. Beveling the extruder tip like us done on the MK II design would be a great idea. I'll pursue that this weekend when I can get out the the drill press at my sister's house.

I took note of Adrian's experience with the filament swelling after leaving the extruder tip. The tip diameter to filament diameter proportion implied in Adrian's report was about 0.79. I worked backwards from this and determined that drilling a 3/32nds diameter hole in the extruder would result in a 3 mm filament. In practice that works out fairly close from the measurements I took this morning.

It seems obvious at this point that if we are going to extrude CAPA in this temperature range we are going to have to cool and support the filament almost immediately after it leaves the extruder tip. Otherwise it is going to draw into a thin thread because of the weight of the cooled filament end acting on the emerging polymer which, because it is molten, has a negligible tensile strength. Perhaps I can fabricate a little PTFE trough to provide that support.

08:45 PDT AKA 16:45 ZULU TIME 8 March...

It occurred to me that I had a little PTFE trough already made in the reject misdrilled bits of PTFE cylinder that I had made. I sawed one of those in half and taped it into place. You can see the result. (hmmm... pics don't seem to be uploading right now)



The filament extruded into the trough all right but promptly adhered to the PTFE surface IN the trough. It seems that drilled PTFE surfaces are quite rough, a circumstance which probably explains how we can pump polymer through the PTFE thermal barrier in spite of the fact that the

friction coefficient of PTFE is so low.

I also tried dripping water onto the filament as it emerged from the extruder tip



That worked to an extent but I had to be careful not to drip it on the extruder tip which chilled it and caused flow problems.

We appear to have another successful filament extruder concept...

Wednesday, 8th March 2006 by Forrest Higgs

20:45 PDT AKA 04:45 ZULU TIME 8 March...

Not to put too fine a point on it, the upgraded Mk II concept filament extruder... extrudes filament.

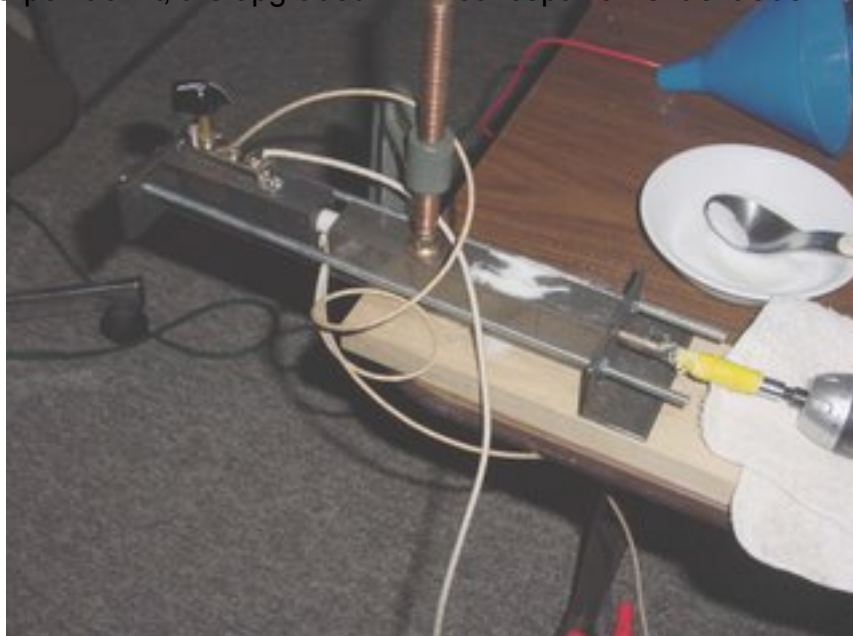

I decided to do the first run hot so that I could avoid problems with jamming. I set the thermostat on the heated barrel to 150 Celsius and let the system heat up for fifteen minutes keeping track of the temperature. When it hit 150 I began priming the polymer pump. Within 5 minutes molten polymer began to be extruded. I caught the output on a ceramic plate. The filament was too hot, as I expected and although it emerged with a diameter of approximately 3 mm gravity quickly stretched it thin.



The product landing on the plate had no coherence in diameter.

Because I was working alone and was standing in for a thrust bearing for the test rig and spooning polymer into the feed chamber as the experiment was underway I was unable to photograph the extrusion as it took place.

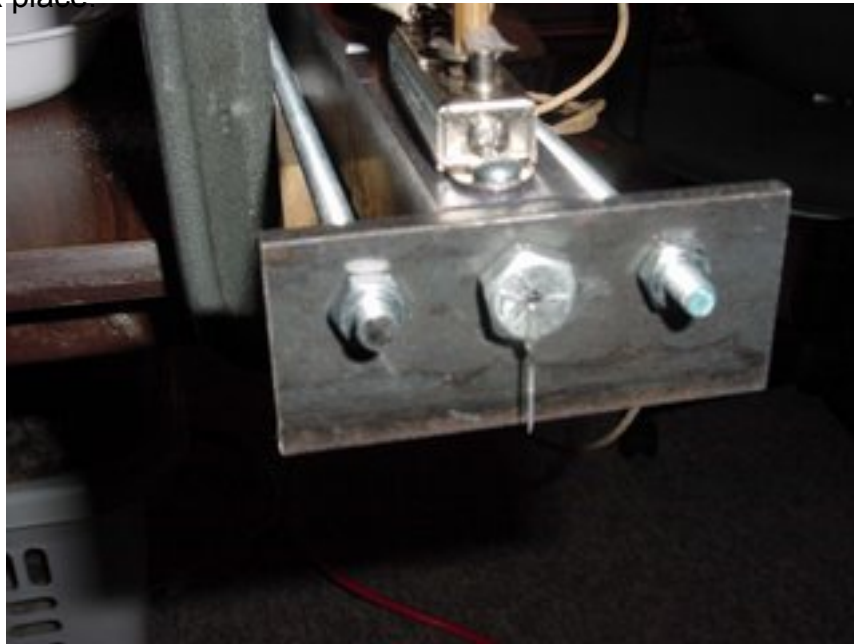

Here is a photo of the extrusion tip after I shut the system down. You can see a thread of filament remaining on the cool tip.

The first few feet of filament was dirty with grit and grease from the machining of the barrels. That soon cleared, however, and the last filament extruded was clear. CAPA turns translucent when it cools. It feels rather rubbery and is quite strong even in thin cross sections.

In the next days I will endeavour to configure the rig so that I can operate it with hands off. I will also have to figure out a way to connect the electric screwdriver to the extruder with something a little less informal than duct tape. :-)

Interestingly, the electric screwdriver provided more than enough torque to operate the system. There was no jamming of the system for any reason. As well, I was able to manually resist the axial thrust against the screw pump. Apparently, the larger diameter extrusion orifice means that the operating pressure in the heated extruder barrel is considerably less than I expected. That is wonderful! :-D

I think as well that it would be good to slightly incline the extruder so that the filament doesn't try to hang onto the extruder tip. Having a water tray directly under it would also be a good idea. Godet stations and a takeup reel system are something that somebody might want to think about rewrapping before too long.

I will also do a series of test runs at lower temperatures to find a more optimal operating regimen. I'd like to find a less informal gear motor to integrate into the system. I don't get the impression that the plastic gear motor that we use on the Mk II is going to be up to the job. I think that we will need just a little more torque than that motor can deliver. On the other hand, I get the impression that this system will produce filament at quite a good clip.

It would appear that the only reason for going to a larger diameter auger would be to be able to handle polymer in larger granules.

Using the masonry bit appears to have made all the difference at the last.

I would like to thank everybody on the team for their advice and observations. Thanks goes to Dr. Bowyer who also ran with the concept using several different assumptions and whose example prodded me to work a lot harder than I would have on my own.

Finally, especial thanks go to Vik and Brett, whose timely last minute suggestions and encouragement yesterday got me past the jamming problems that I encountered. I was very discouraged at that point. I don't think I would have attempted to run the auger through the thermal barrier and into the extruder barrel had Brett and Vik not suggested it.

Thanks guys. This has been and continues to be a LOT of fun.

Closing on producing usable filament...

Thursday, 9th March 2006 by Forrest Higgs

I realised late this afternoon that I need not build a framework as such to hold the quarter-inch extruder vertical. Ten minutes with a few pieces of scrap lumber and C-clamps gave me a solid platform for operating the extruder vertically. A water bath was created with a fruit juice jug and a piece of construction paper formed a makeshift polymer bin.

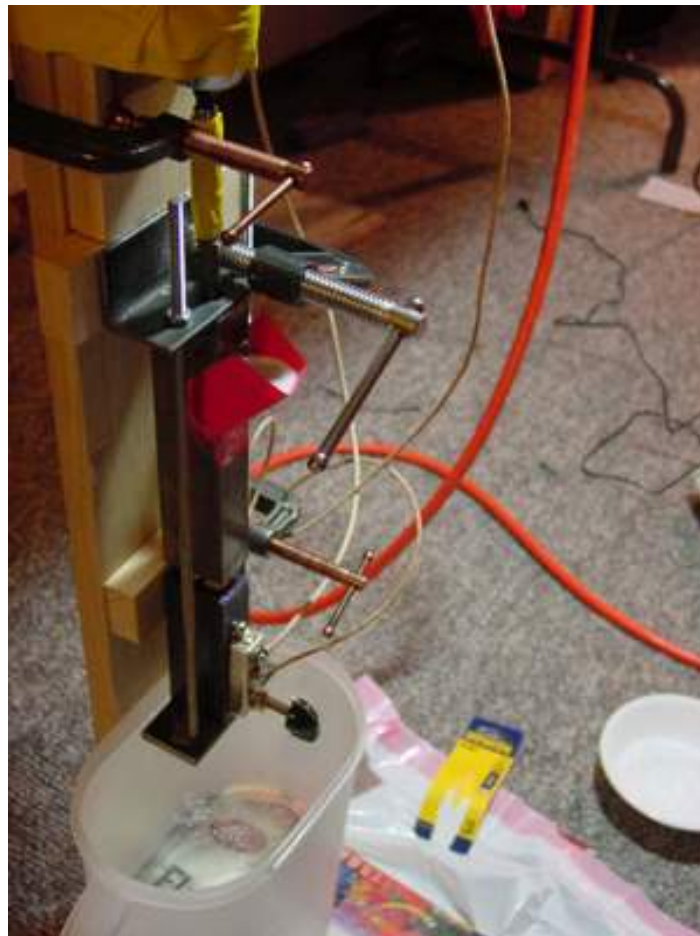

The water bath was situated about 2-3 mm below the extruder tip. I heated the extruder barrel to 120 Celsius and started the system.

This was the result.



The filament emerging from the extruder was instantly quenched in the water bath. The diameter of the resulting filament varied between 3.2 and 3.9 mm. The kinks that you see occurred when I had to manually poke the polymer feed bin with a thin bamboo stick to keep it filled.

Interestingly, the filament floated. This might indicate that we are entraining air in the filament since the density of the CAPA is marginally higher than that of water. No obvious bubbles were visible, however.

The practicality of Brett's advice that we need to think about designing a polishing station to straighten and regularise the dimensions of the raw filament now becomes obvious. That should be a perfect RepRapable product.

The extruder produced about 125 mm of filament in approximately 90 seconds. For these settings that is an output level of approximately $50 \text{ cm}^3/\text{hr}$. I had designed the system to produce about 15 times what a Mk II could consume per unit of time. We're producing about 18 times which is very close to our design goal. I currently have no way of knowing what the duty cycle of the bimetallic thermostat was, but given the setting chosen even if the cartridge heater had been on full-time it would have had a power demand of no more than 150 watts.

What we have is a prototype that proves the concept for a small polymer extruder. We need to take the concept through several generations now to achieve a useful system. I see several developments as being needed to make this a start-and-forget system.

- an improved polymer feed hopper that makes sure that the auger receives a steady supply of resin.
- roll godets
- heating oven
- takeup reel

It would be nice if this system could be self-threading. We obviously need to design a hands-off control strategy now that we have a way of making filament. Given the work that has already been done by the team with controlling steppers and the Mk II I have no doubt that we have the talent already on board to do this.

Here is the system that we are replicating.

It costs US\$85,000 used. We're going to do it for under \$150 tops as best as I can see.

UDN2559 Stripboard design, take 2

Monday, 13th March 2006 by Vik Olliver

The UDN2559-based stripboard stepper driver is taking shape. The first one works, and the stripboard diagram is being used to construct another one to prove that I can get that bit right. If people want to critique, feel free. Note that the 5V and GND wires are in the new configuration on this model. The circuit is on

<http://reprapdoc.voodoo.co.nz/bin/view/Main/StepperDriverWithUDN2559>

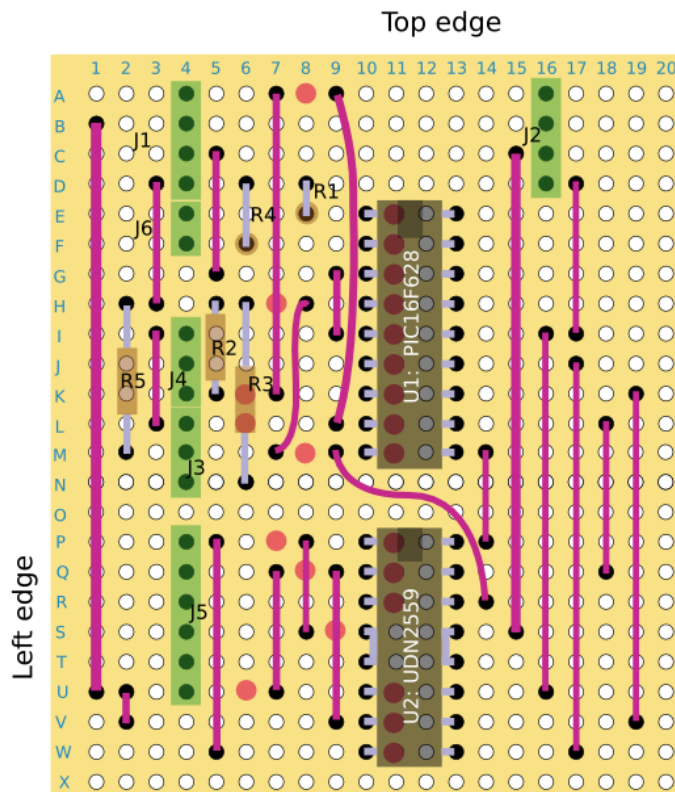

Circuit source (gschem) and layout source (SVG) available on request.

Vik :v)

Polygon software

Tuesday, 14th March 2006 by Adrian Bowyer

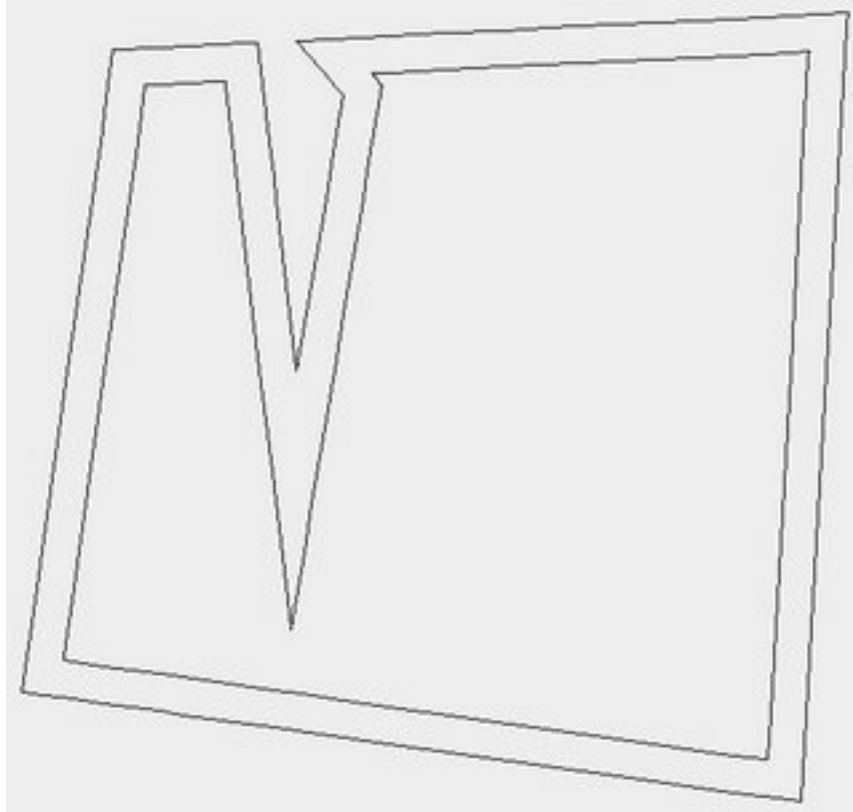

When you slice an STL file with a plane, the result is one (or more) polygons. These have to be filled with RP goo somehow to make a solid in layers. As we are going for FDM, this means offsetting the polygon by half the width of the stream, outlining it with goo, then offsetting again and cross-hatching to fill the interior.

I have been writing Java software to do this. I have decided to do a CSG implementation of polygons as unions, intersections, and differences of planar half spaces (i.e. you treat an infinite straight line as being solid on one side and air on the other so, for example, if you intersect three such you make a triangle).

The reason for this is that, compared to the more obvious solution of storing a linked list of line segments between vertex points, once you've got it working it makes polygons that are guaranteed never to self intersect, are easy to offset correctly, and can themselves be easily combined using boolean operations. The downside is that you have to turn the original slice into a CSG form from what is basically an unstructured bunch of line segments that may join up if you're lucky. Fortunately there's an algorithm for that - Tony Woo's alternating sum of volumes algorithm. Implementing that is my next task.

The picture above shows a test polygon, and the result of offsetting it. If you increase the offset, it all behaves nicely, and automatically avoids lines crossing each other:

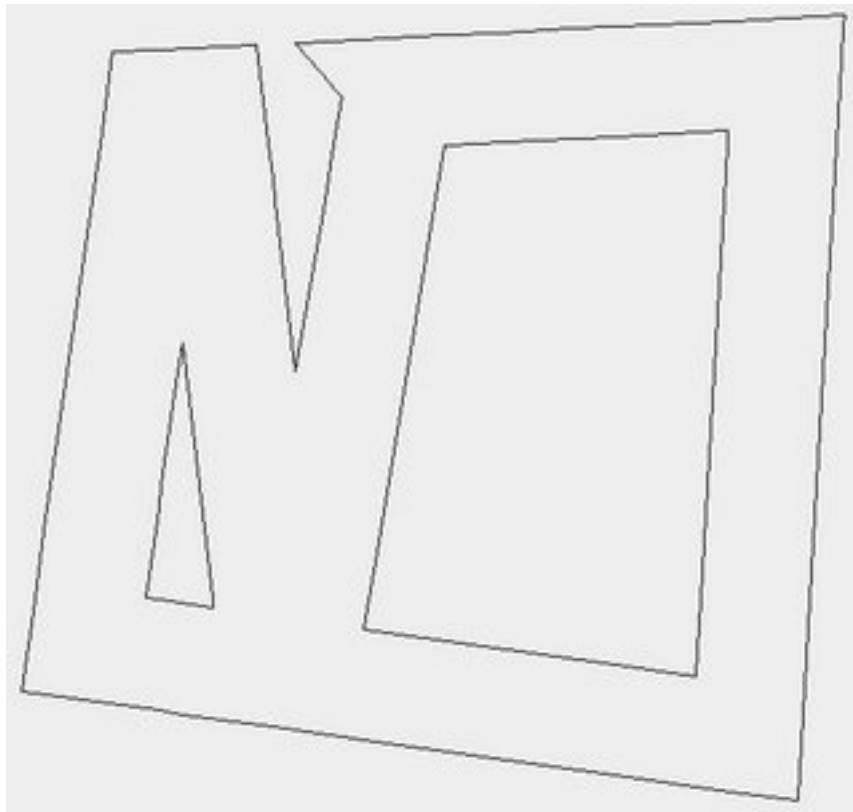

Cross-hatching for infill is fairly easy. Here's an inner and outer polygon, both offset, then the result cross-hatched:

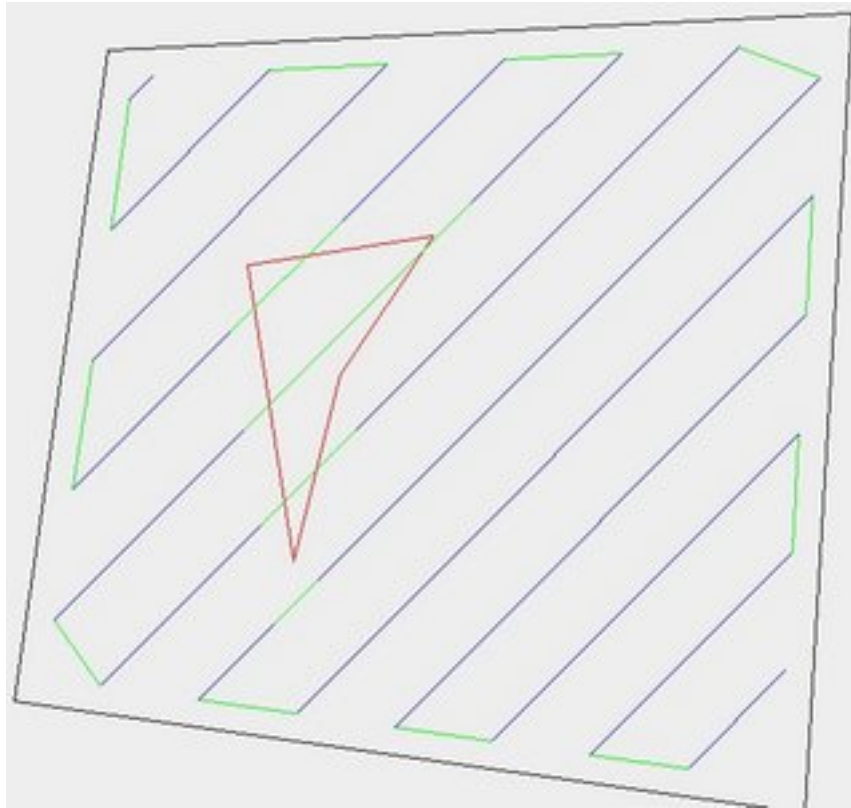

Though I haven't finished that yet - it detects the region in the middle to avoid (different colour), but doesn't link up neatly around it to minimize pen-off-the-paper moves.

How do we do a whole 3D object?

Well, Java3D will read STL files. We slice them from the top down in layers. Imagine that you're at layer N , and the next layer up where you were before is layer $N-1$. If U is union, $-$ is set difference, P_N is the polygon now (at layer N), and P_{N-1} is the one above, then:

1. Get slice P_N .
2. Fill P_N with build material.
3. Fill $P_{N-1} - P_N$ with support.
4. $P_N \leftarrow P_{N-1} \cup P_N$.
5. $N \leftarrow N + 1$.
6. If not off the bottom, go to 1.

That defines exactly what needs to happen right the way from the top to the bottom. You work it all out, then play it in reverse from the bottom to the top. This is all particularly simple if U and $-$ are trivial operations, which they are in my implementation. Offsetting is pretty simple too, so things like being able to build slight overhangs without support can easily be accommodated by replacing Step 4. with:

$$4. P_N \leftarrow O\{(P_{N-1} \cup P_N), -\text{shrink}\}$$

where $O\{\text{set}, \text{distance}\}$ is the offset function, and shrink is the width of the overhang that can be sustained.

Job done...

First Microchip PIC16F628 for Godzilla project programmed...

Tuesday, 14th March 2006 by Forrest Higgs

This ought to keep everyone laughing at my expense for a week. Have fun and welcome to it! :-D I built the JDM PIC chip programming board more than a month ago, but just got around to trying to program a 16F628 chip on it this weekend. This is an important thing to be able to do because the 16F628 is the core of all the controller boards for the Godzilla prototyping machine. Simon, Vik and Adrian have been moving towards a final design for all the boards for the past month and it is looking like I'll be able to start building them in a week or two.

Anyway, the first bit of drama was finding the proper software to drive the board and program the 16F628's. As usual it was right in front of my nose and Simon kindly showed me the link. He then told me the settings to use to get it to work.

I plugged the board into my PC, fired up IC-Prog and had a go... nothing. For the next several hours I played chimpanzee on a keyboard trying things to see if I could get it rolling... nothing. Simon began to suspect that my ancient skills with soldering iron and PC board had maybe slipped a bit. Given that it had been 25 years since I'd last personally built one it sounded reasonable but annoying all the same. I considered just buying a premade, cheap programmer board.

Simon finally ran me through the troubleshooting protocol on the wiki site. The voltage numbers that I got made absolutely no sense whatsoever. I was going blind with fatigue when I finally crawled under my desk and had another look at the back of my PC. 25 pin cannon female connector for Com1, 9 pin cannon male connector for Com2... I'd rigged mine to use the 25 pin connector, just like the old days.

Wait a minute. Where was the printer connector? In the old days we used a Centronics connector, but those had fallen by the wayside some years back and NOW we used a... 25 pin cannon connector... female. It was still confusing because when I checked mode I had 2 serial ports. If that 25 pin cannon female connector was a printer cable where the hell was the other serial coms port? I've been using USB ports for peripherals for some years now so this was all remembering how to read ancient Egyptian for me.

I finally decided that I didn't know where the other coms port was but that the one I had had to be a 9 pin male cannon connector. This morning I went down to Radio Shack and bought a 9 pin female connector. I hooked it up ran IC-prog with the settings Simon talked about yesterday. It wrote to the 16F628 and verified perfectly the first time out. I read it back into buffer 2 and compared buffer 1 and buffer 2 and it gave me a thumbs up.

Making Version 2

Tuesday, 14th March 2006 by Forrest Higgs

Brett has kindly agreed to knock out a few kits for version 2 of the filament extruder and made some very valuable contributions towards its design. He has access to metal scrap the quality of which I can only dream about.



Here are the first two extruder barrels that he's fabricated. They're made of a good quality stainless steel so we should be in better shape with the colouring of the filament if my guesses about how they're getting coloured is right.

First off, version 2 will have a 1" diameter extruder barrel. The reason for this was my serendepitous discovery of a high quality, extremely cheap barrel heater used by the plastics industry in conventional extruders.



Its a sleeve heater designed to fit over cylindrical bits of plastic extruders to keep molten polymer inside molten. This bad boy prices in at about US\$6-7 for a 300 watt heater. It can be bought for either 110 v or 230 v AC mains power. The cartridge heater it replaces costs closer to US\$10-15.

The only drawback to this kind of heater is that it makes the use of a bimetallic thermostat as we were able to do with version 1 impossible for the simple reason that there is no place on an extruder barrel covered by this heater to mount one. That is not a big problem in that the controller for the Mk II extruder that is being used on the RepRap itself already makes use of a thermistor temperature sensor for control. I am sending along a kit of pieces for version 2 to Simon who has kindly agreed to morph the Mk II extruder controller board design into one that can handle version 2.

The polymer pump will be made, according to Brett, from 1.25"x1.25" stainless steel bar stock. Overall, version 2 will weigh about half of what version 1 did. This is especially important in the extruder barrel in that it will have a much smaller thermal inertia than the version 1 did. The sleeve heater should also make for a much more evenly distributed thermal input to the polymer.

Results of a complete breakdown of the quarter-inch extruder...

Tuesday, 14th March 2006 by Forrest Higgs

After having removed the auger and cleaned it I left the extruder barrel heater on at 120 Celsius to cook out the rest of the polymer out of the barrel. Afterwards, I disassembled the system completely.

The first thing I noticed was that the half-inch PTFE thermal barrier between the polymer pump barrel and the extruder barrel showed signs of swelling. Whether this swelling is an artifact of the heat that has been applied to the extruder barrel or the pressure that has been developed in the upper reaches of the extruder pump, or both is not known.

What was more interesting was the observation that polymer had not only coated the hot end of the auger but also formed a nice tube between the auger and the inside the PTFE thermal barrier.

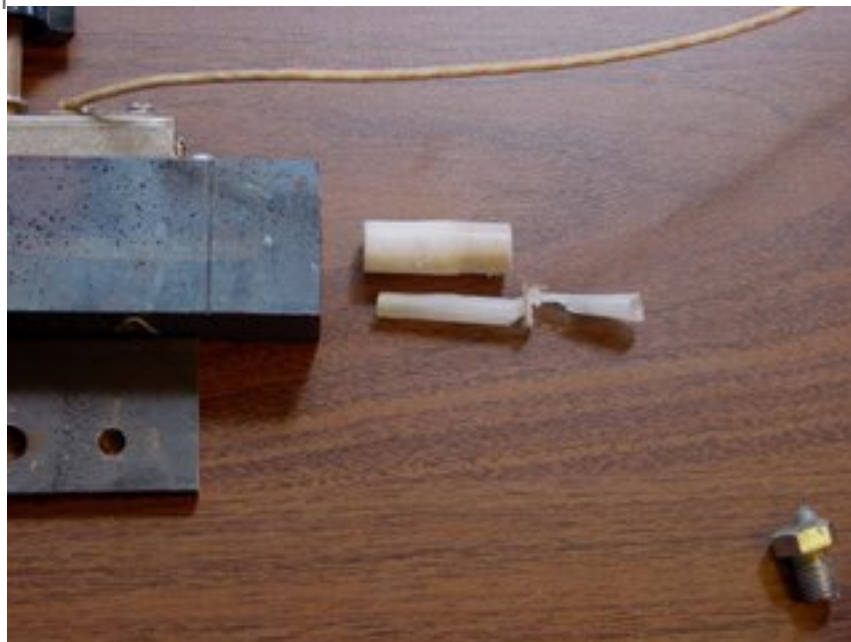

Not only had it done that, but it had also migrated another 24 mm up the polymer pump barrel even though molten polymer had not previously been observed on the auger that far back from the extruder barrel.

Given that the system had not been broken completely down for cleaning since it began to be operated it is not clear whether this polymer tube was formed all from the get-go or later on.

Two interesting observations came from looking at this CAPA tube. First, the swelling of

the PTFE barrier comes from the inside and is expressed in the tube wall thickness. Second, and even more interestingly, the tube is a clear, clean white all the way down to the end of where it exits from the PTFE barrier into the extruder barrel. Extruded CAPA, on the other hand, has been a light silver-grey. Further, there are no flakes in the tube whereas you will occasionally see a flake of dark matter in the filament.

This argues that the CAPA goes from white to silver-grey *in the extruder barrel*.

I'm drawing two initial conclusions.

- we are developing pressures in the extruder barrel sufficient to cause a bulging of the PTFE thermal barrier
- we are seeing either a purely thermal transformation of the CAPA colour or a thermally driven interaction between the CAPA and the mild steel walls of the extruder barrel that causes the colour change

More post extrusion filament treatment...

Tuesday, 14th March 2006 by Forrest Higgs

Solvay lists the melting point of CAPA at 58-60 Celsius. I created a water bath of that temperature on my stove and dumped in the filament produced with yesterday's experiment.

The filament instantly became soft and pliable. Straightening it was no problem at all, though it did break at one of the weak points where the extrusion rate had slowed down when it was being extruded.

One error in yesterday's observations was apparently in reporting that CAPA floats. Today it sank immediately, which is in keeping with it's listed density. I am wondering now whether the "floating" behaviour that it exhibited yesterday had to do with its almost neutral buoyancy coupled with the fact that it was still attached to the extruder tip.

Stewart platform, Rev 1.

Friday, 17th March 2006 by Brett

I've been pretty busy at work, but I have managed to make some progress on the Stewart platform. Aside from machining the stepper mounts, (2 complete, 4 in progress) I've been modeling up the assembled platform, to get a look at the geometry.

First, an over-view: The frame, (Not all shown) will consist of a space frame with a triangular base and top. Suspended from the top triangle by pipe hangers are blocks which allow lengths of 8m1 threaded rod to freely pivot. At each end of the threaded rod are yokes which suspend the stepper mounts. At the far end of each actuator is a yoke connecting to a pivot attached to the tooling plate.

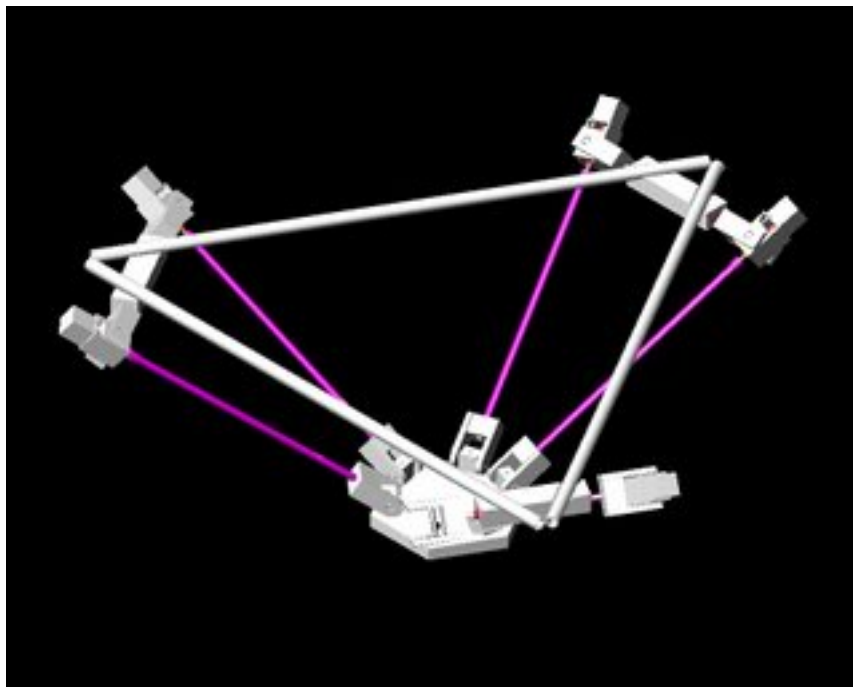

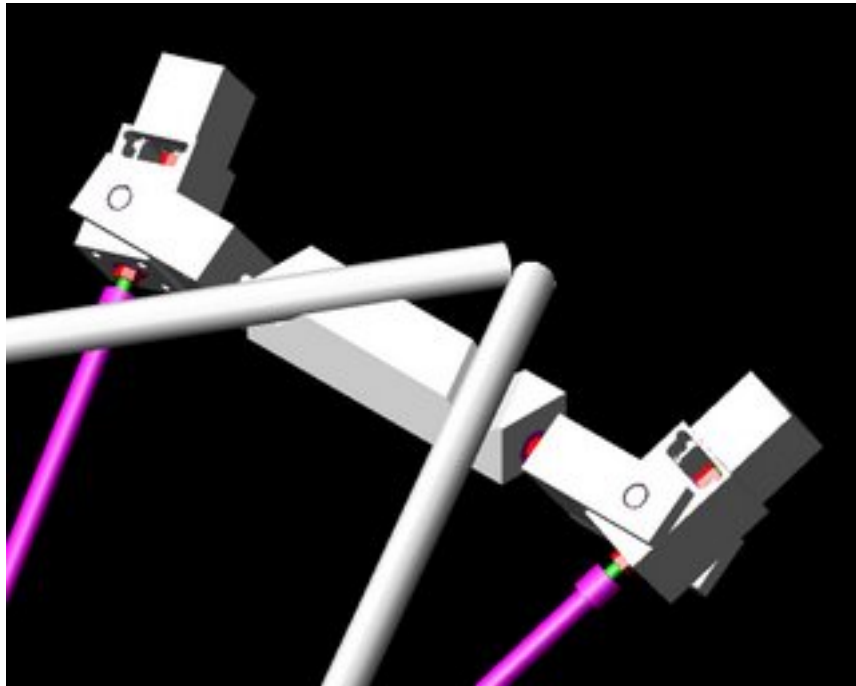
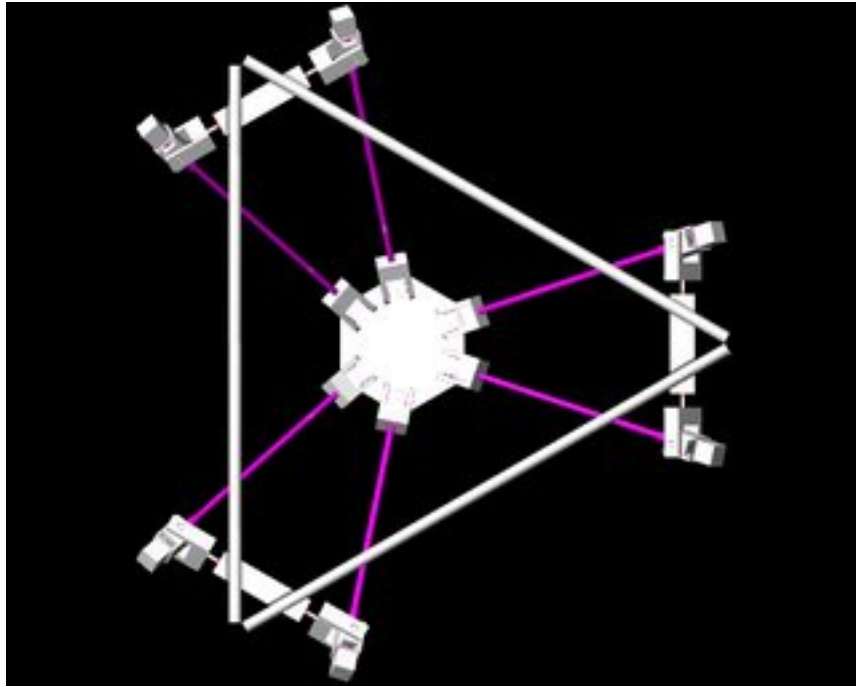

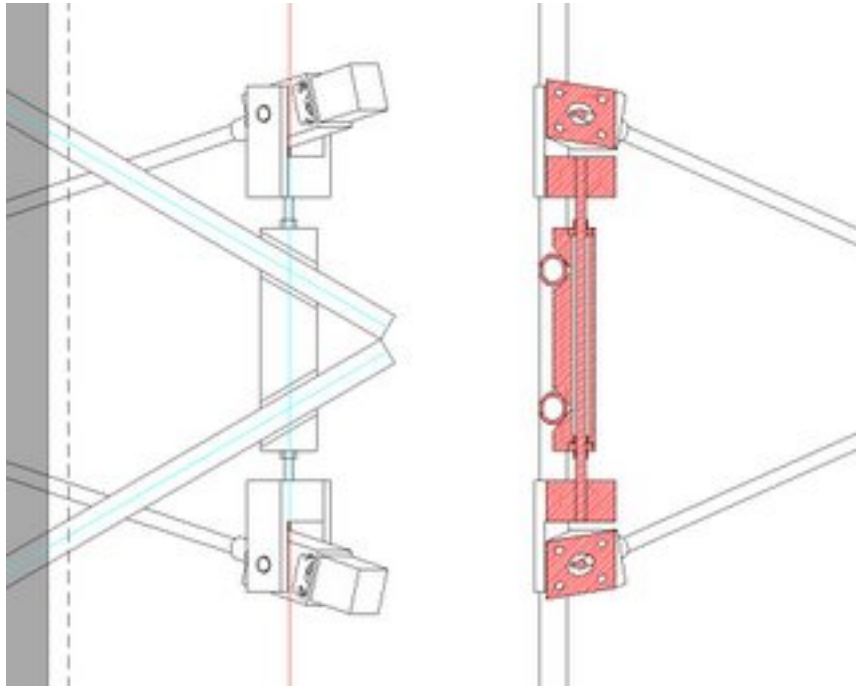
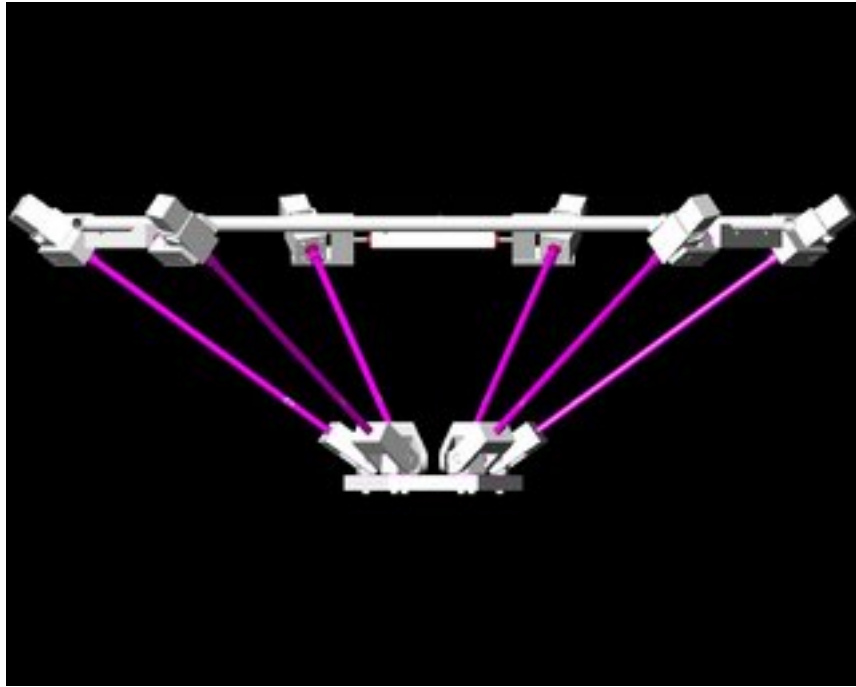

All the pivots are designed to use inline skate bearings, which are fitted around either 8m1 threaded rod, or 8mm shoulder screws.

The yoke designs are still a bit clunky, and I need to model up the extruder to confirm that it will fit, and determine what kind of tilt angles are feasible.

Continued filament extrusion experiments.

Saturday, 18th March 2006 by Forrest Higgs



This evening I made another extrusion test. This time I began with a thoroughly cleaned extruder assembly and used a quenching bath heated to about 55 degrees. The extruder barrel was heated to 120 degrees. CAPA 6406 was used.

As you can see in the picture the first few centimeters of extrusion was darkly coloured. Interestingly though after that the filament was a uniform white very much the same colour as the CAPA 6800 pellets.

Filament diameter varied between 2.9 and 3.2 mm. Approximately 450 mm of filament was extruded which weighed 3.6-3.8 grams in a matter of a few minutes.

Using the heated quenching bath changed the nature of the extrusion filament dramatically. This filament was flexible. As well, the warm water was much more forgiving of irregular extrusion rates. No serious weakpoints in the extruded filament were observed.

One change that wants making in the version 2 extruder is a different feed arrangement. Version one was designed to be operated in a horizontal position. This creates flow problems for the polymer powder into the feed chamber.

Afterwards, I cooked off the extruder barrel and removed the auger. The auger was covered with melt for the length of the PTFE thermal barrier. There were a few small bits of partially molten polymer powder in the feed barrel near the PTFE thermal barrier. Similarly, there was a bit of molten polymer powder at the end of the PTFE barrier on the extruder barrel side. These "bits"

were a few mm in length and width and perhaps half a mm thick.

Clearly, the CAPA tube that had formed in PTFE barrel had done so over several operating cycles.

Right now the length of operation of the extruder is dependent on the time that it takes the duct tape joint between the electric screwdriver and the auger to fail. It will be interesting to create a joint which will not break and then let the extruder pump clean itself to see if that makes cleaning the system easier.

New cable wiring and connectors

Sunday, 19th March 2006 by Simon McAuliffe

Not much progress on the electronics recently because I've been slowly converting designs and my existing boards to use the new cable wiring.

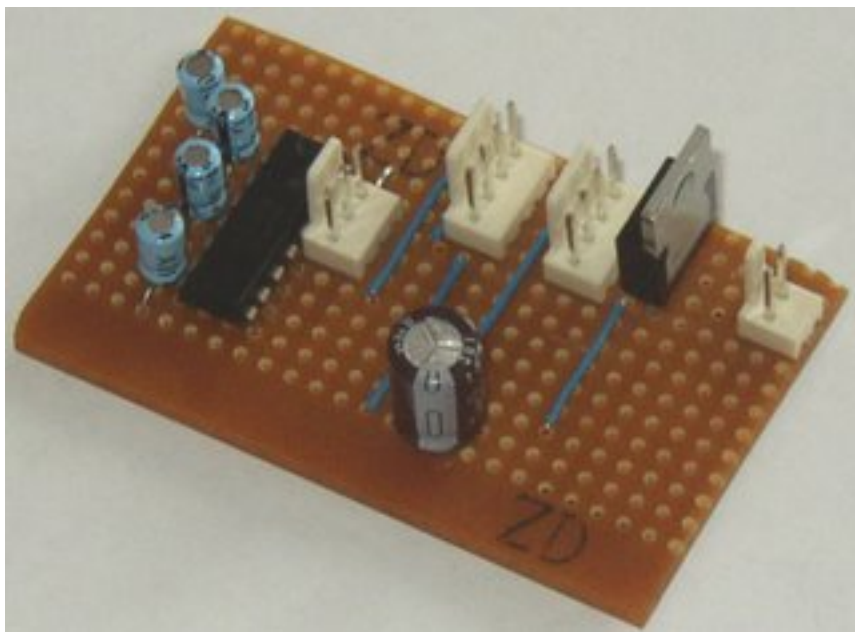

Pictured is the current design of the main interface board that I put together this morning. During the rebuilds I have also switched to a different type of connector. I think these should be fairly readily reprogrammable and they do a good job of preventing you from putting things in backwards. They're also moderately cheap.

Getting the filament out of the bath...

Tuesday, 21st March 2006 by Forrest Higgs

Brett said...

The alternative, of course, is to draw the tempered filament down through a tapered die, like drawing wire. If that die is kept cold, it will skin the filament over, and then you just have to take care not to draw it so fast that you overrun the extruder.

We've got to have a hands-off filament maker or we will drive ourselves crazy making filament to keep the reprints fed. We've pretty much solved the problem of extruding the filament on a small scale and we know that we can quench the filament in a water bath.

Then what? Right now we have filament that looks like squiggles. We know that we can heat the quenching bath and keep the filament pliable. Now, how do we get it out of the bath and onto a takeup reel.



How about if we put something like this just under the surface of the quenching bath water. The extruding filament is just ever so slightly heavier than water, so if we have a conveyer like this that is under water at the extruder tip and comes just out of the water at the other end of the bath and if we ran it at about the rate that the filament was coming out of the extruder tip with a little experimentation we just might be able to tease the filament onto a takeup reel.

Brett's notion of a tapered die can take the form of a pair of chute walls that progressively narrow the path that the filament can take. The warm water keeps the filament pliable and the gentle force applied by the conveyer straightens it.

Rather than wasting a lot of time designing this sort of system and making it with the Stratasys machine, better to buy one from these guys.

<http://www.pololu.com/products/misc/0415/>

They've got all the bits for doing this made from ABS, so I can find out if the concept works without

having to face the problem of how to make something from CAPA which will soften in the quenching bath.

Joins that don't break...

Tuesday, 21st March 2006 by Forrest Higgs

Well, my first attempt at making a joint between the electric drill and the auger bit that wouldn't break... didn't. It slipped wonderfully, though, the moment I started pumping polymer with it. :-(

I drove across town to Seaside to a large art supply shop to see if I could acquire some marble dust to use as filler. When I got there I discovered that both that shop and the much smaller art supply shop about less than two km from my flat are both owned by the same person. The smaller shop hard by my flat had the marble dust, of course. :-p

Quenching baths for CAPA

Tuesday, 21st March 2006 by Forrest Higgs

It appears that the bath temperature where CAPA remains pliable yet has enough tensile strength to hold together is somewhere in the range of 58-60 degrees Celsius. Get any higher than that and the filament comes apart. Get any lower and it is unworkable.

It would appear that a thermostat/heater system with a pretty narrow deadband is going to be required for the quenching bath. :-)

Making the quenching bath be the takeup reel...

Wednesday, 22nd March 2006 by Forrest Higgs

I think Svend and Vik have basically got the inspiration between them for quite an elegant solution to putting the filament on a takeup reel. Here's how it works.

You make your quenching bath out of circular pan, put it on a Lazy Susan and rotate it. Keep the water temperature in it at 58-60 degrees Celsius. Locate the extruder tip near the wall of the rotating bath.

The filament will be forced out towards the edge of the bath and eventually touch it. That will straighten it out and keep it pressed close to the rotating wall of the bath. As the filament lengthens, being slightly heavier than water, it will fall to the bottom of the bath right by the wall.

Viola! After a few hours you turn off the filament extruder and you have a coil of filament lying in the bottom of the bath.

I'll bet you that that works just fine. Orchard supply has just the right sized Lazy Susan that turns on a raceway of ball bearings for about US\$8 for the diameter that will be needed.

I just **LOVE** the bazaar model of technological problem solving! :-D

Retiring the electric screwdriver...

Thursday, 23rd March 2006 by Forrest Higgs

This morning I ran the extruder exercise again under better conditions

- the extruder system had been thoroughly cleaned
- the batteries in the electric screwdriver had been charged overnight
- the electric screwdriver was set for maximum torque
- a chronometer was available
- a more orderly way of keeping the polymer hopper filled using the funnel rather than a spoon had been tested
- the extruder barrel was set to 130 degrees Celsius
- the quenching bath was set to 60 degrees Celsius (it declined to 50 degrees over the course of the exercise)

I also tightly secured the air hose coupling with four screw clamps just for luck.

The extrusion exercise lasted 00:10:59. For the first 4-5 minutes I would estimate that over 75% of the extrusion took place. After that the electric screwdriver slowed down dramatically as the batteries discharged. There was not a linear dropoff in rotational speed. Effectively there were two rotational regimens, viz, full speed and very slow with a transition period of less than a minute. I tried to hand turn the auger when this happened and did not observe any meaningful increase in resistance to turning. The battery pack also heated up to the point where it was hot when a hand was applied to the body of the screwdriver.

After 00:11:59 the electric screwdriver stopped altogether. There was still no untoward resistance to hand rotation of the auger. The batteries discharged state seemed to explain the stoppage, not a change in conditions inside the extruder. This was not obvious in earlier tests of much shorter duration.

Initially in the exercise as the polymer pump filled the extruder barrel there was a quite substantial reverse thrust that tried to push the auger out of the pump. I couldn't estimate the amount of force required to keep the auger in the pump but can only say that it was substantial in that I had to work hard to return the auger to its proper position. After the extrusion started I no longer had to apply any force to the auger through the electric screwdriver to keep it where it belonged. This situation lasted perhaps half a minute.

A few observations about the filament in the quenching bath. The filament...

- stayed transparent indicating that it was molten
- stayed on top of the quenching bath via surface tension, when poked with a bamboo stick it sank
- tried to adhere to the pyrex glass bottom of the quenching bath when it contacted it

Most importantly, however, the filament stayed transparent at 50 degrees when I removed it and placed it on a teflon coated cookie sheet. It immediately turned translucent on contact with the cookie sheet. Clearly, the setting of the temperature of the quenching bath needs more thought and experimentation.

I teased the filament around the boundaries of the pyrex quenching bath with a bamboo stick and kept it in once piece even after I removed it from the bath. The semimolten state of the filament caused it to stretch in a few places when I handled it during the transfer, however.

This exercise yielded roughly 680 mm of filament exhibiting a diameter of 2.9-3.15 mm. Approximately 4.9 cm³ of polymer was extruded during the 00:10:59 of the exercise That is enough to supply a Mk II for approximately 01:45:00 of operation. Interestingly, there was a very slight discolouration of the filament for the first very few mm of extrusion after which the filament exhibited the waxy white colour of the CAPA 6800 granules.

One interesting observation was that the extrusion contained air bubbles at times when it left the extruder tip. These expanded and popped with a quiet little crackling noise The molten state of the filament at this point healed any distortion in the filament that these bubbles caused leaving a very nice, solid filament.

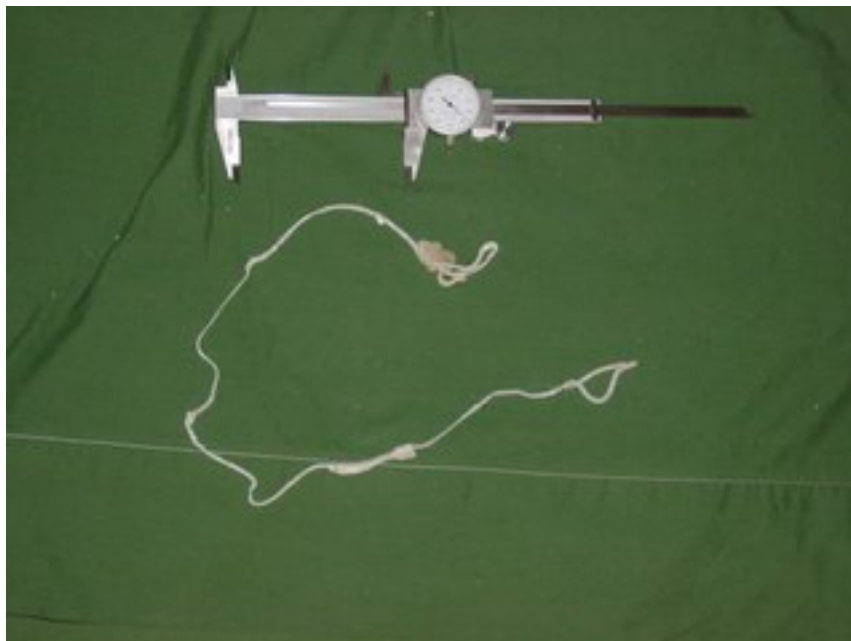

It has become quite obvious that the electric screwdriver is useful only for proving the concept of a filament extruder and that continued running of it at these loads and for these durations will eventually ruin it. For that reason I am discontinuing its use in filament extrusion experiments while it still functions as an effective electric screwdriver. I ordered in its place last night a much more powerful Siemens 12v gear motor rated at 3 amps which is used to operate electric windows. It has a maximum rotational speed of just under 60 rpm which is in the same range as the screwdriver and over 20 times the torque output of the electric screwdriver. The Siemens

gearmotor should give much better service for extended operation. It was less expensive than the electric screwdriver.

I am postponing further filament experimentation until the new gear motor arrives.

Some hours later I broke the extruder down and cleaned it. I encountered the usual polymer melt that extended through the PTFE thermal barrier and 23 mm into the polymer pump barrel. The photograph of the polymer melt clearly shows the transition from fully melted polymer to barely consolidated polymer powder.



It seems apparent now that the vast majority of the thermal energy causing these melts is migrating up the shaft of the auger bit from the heated extruder barrel chamber. Interestingly, the distance into the polymer pump that the melt extended during the current 11 minute extrusion exercise seems to be about the same that was observed with extrusion exercises lasting only a very few minutes. I am looking forward to doubling the extrusion time when the new gear motor arrives and seeing if what happens with the melt length under those conditions.

A workable coupling for the filament extruder

Thursday, 23rd March 2006 by Forrest Higgs

A visit to the local hardware store yielded a short length of 3/8-inch (9.5 mm) ID 200 psi (13.4 atm) test air hose.



That provided a perfect friction fit for the 10.4 mm bit shank and the extender for the electric drill. I didn't even have to use the hose clamps that I had bought to go with it. This joint didn't slip under any circumstances.

I set up to do a filament extrusion test with a 58-60 Celsius quenching bath. Unfortunately, I'd neglected to put a full charge on the electric drill, so it ran much slower than usual which meant that I had a very uneven extrusion rate. All the same, the filament production even under these adverse circumstances was quite good.

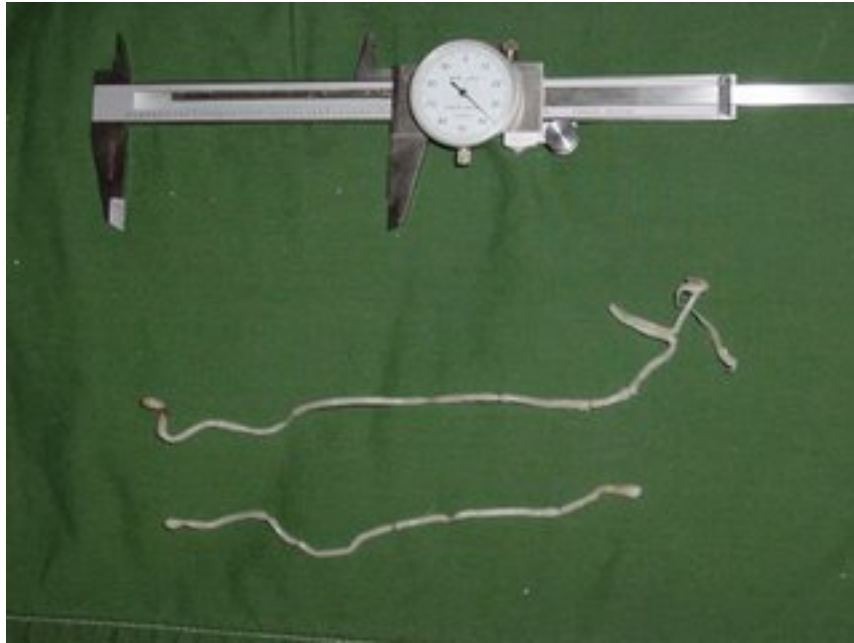

This time I teased the filament out into straight sections with a bamboo stick. In the pic the calipers are opened to 100 mm for scale.

I got an irregular extrusion rate that meant that diameter control wasn't so good this time. Tomorrow I will try it again with a full battery charge and see what happens. If that's good I'll start looking at some marble dust filler mixes to see what goes on with extruding filled polymer.

Networked Extruder Board in Alpha Release

Friday, 24th March 2006 by Vik Olliver

The latest take on an extruder controller board is now available here:

<http://reprapdoc.voodoo.co.nz/bin/view/Main/BuildingAStripboardExtruderController>

If anyone spots any bugs, please let me know.

Vik :v)

ARNIE finds her feet

Friday, 24th March 2006 by eD

Here's the first physical shot of ARNIE.

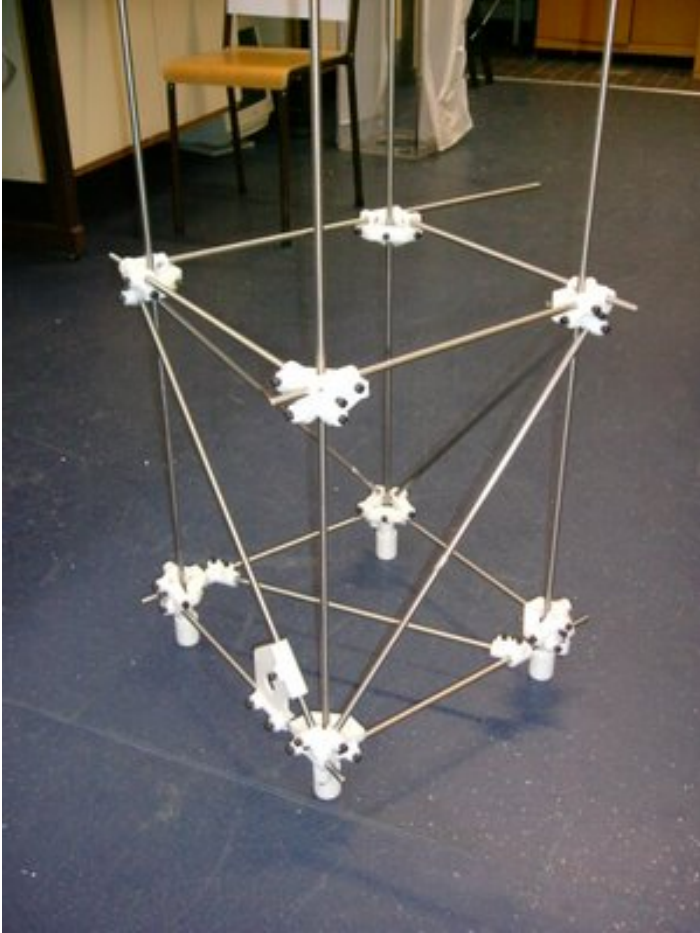

It'll be a good week or so before she'll be up and running. Each of the z-bed's 4 sections takes 25hrs to build on the Strat...

Godzilla comms board just about done...

Saturday, 25th March 2006 by Forrest Higgs

I've just about built up Godzilla's comms board. I'd be finished but I bought components for the board quite some time ago and since then Simon discovered that an extra 1 uF electrolytic capacitor was needed to make it work right.



That's all right though. Looking at the extruder controller that Simon and Vik have got rolling now I'm going to need a few extra ! uF electrolytic capacitors for that in any case, so it's off to Potter's in the morning. :-)

I decided to star 5v and 12 v power to each board instead of trying to put power lines in the token ring communications cable. That simplifies the board a bit in that I don't try to convert 12v power into 5v power on the board with a 7805. It also lets me use 2 pin screw terminals instead of the the larger ones on the layouts in the documentation. This board requires only 5v power which is supplied through the screw terminal on the nearest edge of the stripboard in the pic. The incoming and outgoing connections to the token ring are in the middle of the board in the approximate locations shown on the strip board layouts. I spread things out a bit so that I didn't have those electrolytic capacitors bumping into the legs of the MAX232. I also had to move a few jumpers over a few tracks to make room for a bit bigger than usual 100 uF capacitor. Strip board is very nice about letting you get away with that. :-)

First filament extrusion run with added filler...

Sunday, 26th March 2006 by Forrest Higgs

Just to show my son how the filament extruder worked I decided to try a mix of polymer and marble dust in a short extrusion exercise for the system. The mix was, by volume, three parts polymer to two parts marble dust. That works out to roughly 60% filler. This mix put a lot more torque requirement on the polymer pump to operate, so much, in fact, that the joint between the electric screwdriver and the auger bit failed.

New stripboard layout for bipolar controller tested

Monday, 27th March 2006 by Simon McAuliffe



Image not found.

Looks like I didn't make too many mistakes on the layout. Seems to work quite nicely with the NEMA 17.

I still have to stack another 754410 on the one there and add a heatsink to it.

Ridiculous... :-/

Tuesday, 28th March 2006 by Forrest Higgs

I feel like such a retard. I got the cookie sheet out and repeated the experiment. I got 450 mm of very nearly 3 mm filament laid out straight and turned 90 degrees to make the corner in the cookie sheet. Did that in about 5 seconds. Recharged the piston and did it again ten seconds later.

The filament is beautiful. The dirty barrel nastiness cleared out in the first 5 cm of filament and the rest was pretty clean. There was a bit of blistering on the surface of the filament, but nothing that would affect its usefulness. I extruded at about 95-100 degrees Celsius.



This method could turn CAPA into filament at roughly a kilogram per hour. That's just shy of a half-kilometer of filament every hour. We don't need nearly that sort of capacity to make a go of this.

I wonder if I can do this with CAPA granules. They're a dollar/kg cheaper than powder and a lot less messy.

Serendepity strikes again...

Tuesday, 28th March 2006 by Forrest Higgs

Hey! I'm not claiming to have "invented" any of this, okay? I've been through the archives and I see that Adrian and Vik, I think, did all this on a smaller scale a long, long time ago. Indeed, I originally set out to make a Gingery piston extruder which uses the same principle.

Anyhow, here goes. I had to drill out the extruder barrel to get the marble dust/CAPA mix clear of it this morning. It was quite a mess to say the least. This afternoon I thought about running that mix through the polymer pump again and sort of wilted at the thought. I thought about those push filament through with your hand experiments in the archive. I took the cleaned extruder barrel, insulated it with two scraps of poplar wood, filled it up with the marble dust/CAPA mix and kicked on the cartridge heater. In 2-3 minutes the IR thermometer said that it was nearing 100 degrees Celsius, so I inserted a .25-inch rod into the barrel and gave the charge a tentative push. I estimated that I applied about 10 lbs of thrust which put the cartridge barrel at about 14-15 atm. I emptied the barrel in about 5-10 seconds of steady pushing.

I got a 300 mm long filament out of that which was a uniform 3.175 mm in diameter. Because of the lower temperature and possibly the filler the filament was self-supporting. I caught the filament in a cup of cold water. Here it is. The colour is nasty because I didn't finish the drillout with an alcohol swabbing.



The filament was straight coming out but got bent and twisted in the small cup of water.

What I did here reminds me more than a little of Adrian's bicycle pump filament maker idea. The filament that resulted is quite flexible and more than a little like Weedeater cord in feel.

This mix is 40% calcium carbonate by volume and roughly 60% calcium carbonate by weight.

If this mix produced a usable filament in the Mk II it would bring the cost of extrusions down from US\$12.73/kg to US\$8.52/kg. I suspect that if we bought marble dust in 20 kg sacks like we will the CAPA that our mix price would drop to somewhere in the vicinity of US\$7.73/kg.

The quality of the filament and the ease and speed of it's manufacture has got me to thinking about the notion of a reciprocating piston extruder again. Brett brought up something like that in a discussion we had some weeks ago. Hmmmm...

LOL! :-)

Potential support material...

Wednesday, 29th March 2006 by Forrest Higgs

This morning I made up a CAPA/marble dust mix of 1 part CAPA to 2 parts marble dust. By weight that is an 81% filler mix. I was able to extrude it with little trouble.

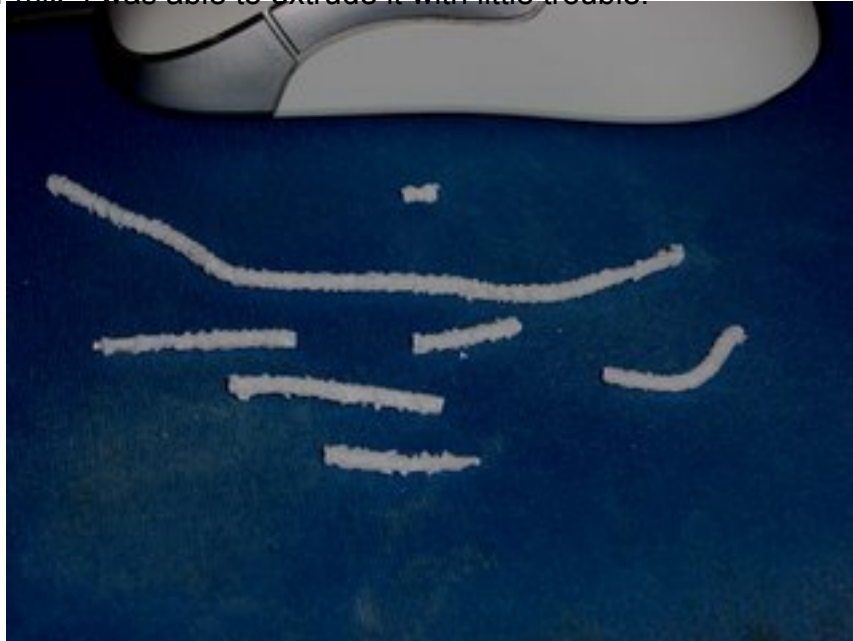

The resulting filament was spiky and rough to the touch. I am guessing but suspect that the spikes are pockets of marble dust. I would need a microscope and coloured CAPA to be certain.

After it cooled the filament could be broken with minimal bending. It was very fragile and as a support material would be perfect. It may be that we have to use this support material in rod form unless we want to use a little more CAPA in the mix. We can extrude it using retail marble dust for US\$4.30/kg and US\$2.50/kg for marble dust in 20 kg bags.

I suspect that the surface treatment of the filament would be better if the filler and polymer were more thoroughly mixed than I was able to do with a bamboo stick. It might be that we could get a filament that we could coil if we did that, too.

Just as a side issue, I had my first RepRap research accident with this experiment. I forgot to seat the cartridge heater in the extruder barrel before turning on the system. The cartridge heater was sitting on top of a piece of scrap poplar. I went back to my PC for a few moments to let the extruder barrel heat up and, when I detected the odor of toasted poplar, got up to make the extrusion. I found that the cartridge heater had charred its way through about 5 mm of poplar and had a cheery little flame started on it where it lay on the table. About 75% of the cartridge heater had reached orange, not red, hot.

I shut down the electricity figuring that I had ruined the cartridge heater. After it cooled, I seated it in the extruder barrel and turned it back on. Amazingly, it worked perfectly. I have a whole new appreciation for ISM heating elements' robustness.

First polypropylene extruded...

Thursday, 30th March 2006 by Forrest Higgs

I had some polypropylene cord lying around, so I decided to see if I could extrude it with the heated extruder barrel and piston that I've been using for the filled CAPA. It turns out that I can. I was able to force an extrusion at 155 degrees Celsius. I suspect that the temperature needed to be a bit higher and the rate of extrusion a bit smaller. As it was what I got looked rather like the result of stepping on a tube of toothpaste lying on the floor (yes, I have done this) with it's top off. I don't think that I will include a pic of this particular result. :-s

Interestingly, an extruder tip orifice that was yielding approximately 3 mm filament for CAPA is yielding 5 mm filament for polypropylene.

Another hopeful effect was that most of the contact points between different parts of the filament aggregation were thermally welded together. Not all were, though.

This evening I ran another exercise with polypropylene at 165 degrees Celsius and a slower, more controlled extrusion rate. Although the filament quality was still poor, it ran at a diameter of about 3.15 mm. It was also warm enough that it did not tend to tangle as it did with the first experiment. The melting point of polypropylene is listed in the literature at 170 Celsius. One usually expects the working temperature of the polymer to be considerably higher than its melting point.



Oddly, while more force was required to create a filament than was the case with filled CAPA polymer it was not an excessive amount of force.

I suspect that polypropylene is about the highest temperature polymer that it *might* be possible to use in a rewrap. My worry is that an extrusion thread will cool too quickly to weld onto previous

layers in a room temperature environment.

It would be fun and informative to see if a Mk II could produce the temperatures necessary to melt a polypropylene filament and whether we could prototype with this polymer.

One thing to remember about polypropylene is that it won't melt on a hot day or if you spill your tea on it. It also costs 35% of what CAPA does. That's why I keep looking at it. :-)

Slave board built

Sunday, 2nd April 2006 by Simon McAuliffe

This is what the stripboard bipolar controller slave board currently looks like. The larger of the two boards is the master controller. Each board drives one motor, and these can be chained together as needed for the number of motors required. This is used in cases where multiple motors must be driven for the same axis in exact synchronisation.



Image not found.

Also note the stacked/piggybacked 754410's on the master (click for close-up image). The slave doesn't have the extra 754410 yet because I've run out. I still have to add heatsinks to both too.

More details [on the wiki](#)

Godzilla comms board is operational...

Monday, 3rd April 2006 by Forrest Higgs

After a few false starts this morning I got the comms card for Godzilla working. It is echoing properly both with hyperterminal and the VB.NET serial comms test programme.

The board takes on 5v power directly from the power supply and does not have any 12v current moving on the board.

Connections with the rest of the system are via 2 pin screw terminals. No power is carried in the comms cable. The PC serial port connection is wired directly into the board.

Now I can start building up a stepper controller with confidence that I have something to connect it to. :-)

First try at a stepper controller for Godzilla...

Tuesday, 4th April 2006 by Forrest Higgs

LOL! Well, once again I begin to strongly suspect that there must have been fine jewelry makers in both Vik and Simon's ancestry while my own must have been lucky to hang onto a hammer with both hands. :-s

Last night I began trying to build Simon's beautiful, tiny stepper layout on a euroboard. I figured that it would be easy enough to just lay his slave board further down the euroboard instead of using that nice amp connector which I don't have in-hand. The remainder of the evening and early morning here was punctuated by a series of demerits in my expectations for how far along I expected to get. :-)

My first downgrade in expectations occurred when I had a close look at the pic of the master board where Simon had stacked two 754410's. I had always been a bit suspicious about whether stacking chips like that was a good idea. Looking closely at the quality of soldering of the two chips' pins together put a whole new light on the matter, however. Not to put too fine a point on it, Simon's usually beautiful soldering work looked nasty on that particular bit of the master board. It didn't take a great stretch of imagination for me to draw the conclusion that if Simon's usual impeccable soldering work suffered that badly on that kind of stacking that my own would be so bad as to make the task totally impossible. :-)

Okay, not a problem. So my first attempt at a stepper board would have two, unstacked 754410's instead of four 754410's stacked in two modules. Who knows, maybe Godzilla wouldn't require the torque that four would allow. :-D Mind, I'd already halved the torque by going for 12v and halved it again by having the 754410's. Not to worry, though. The exercise could be a concept proving one rather than an end product. I'd have learned a lot about stepper boards even if I didn't get a finished product the first time out. These are early days for reprints, after all. :-)

The next expectation to fall by the wayside was putting the slave board on the euroboard first time out. It wasn't impossible, mind, given my modest skills. It was just adding complication and expense to an exercise that was going to be hard enough for me to accomplish in the first place.

As I began to lay out that minor mare's nest of jumpers that looked so reasonable in Simon's pics I began to realise that I was in the middle of another JDM programmer board nightmare. The clearances and tolerances for those jumper paths were simply more than my poor motor control skills and fingers could cope with. I didn't want to junk the board though and get a bigger one for this exercise like I did with the JDM board. Simon's design looked considerably less difficult than the JDM in a lot of ways, so I soldiered on.

One thing that made things easier was dropping the self-imposed requirement that connecting

jumpers had to be flat with the board's surface. That made making the connections much, much easier and sped the work up dramatically.

Right now, the stepper board is done except for the wireout to the NEMA 17, seating the PIC16F628 and that capacitor between ground and the 5v power supply that isn't shown thus far on the schematics that keeps the electromagnetic noise from the steppers running from getting into the control circuitry.

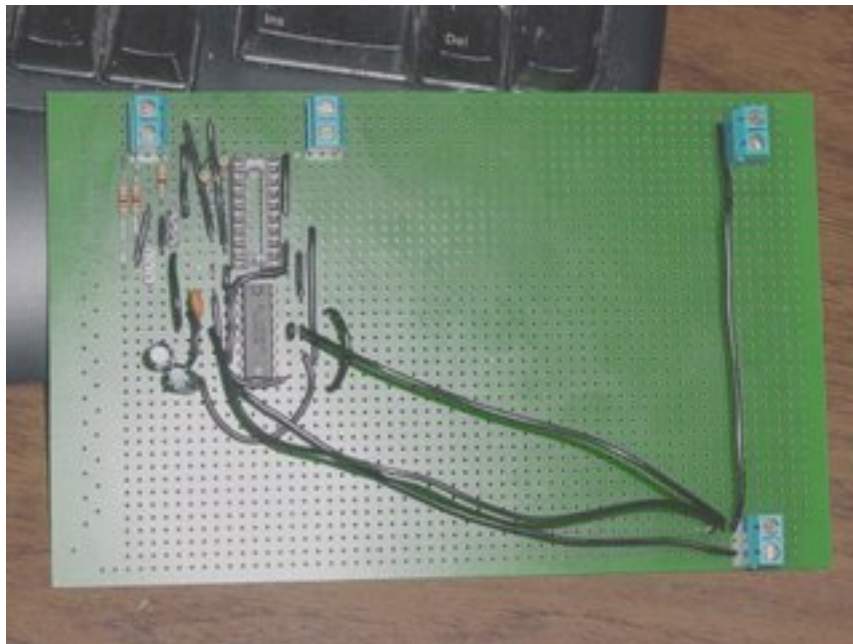

I'm staying with the two pin screw terminals approach that separates power from communications. The serial comms ports are the two terminals on the top, left hand edge of the board.

The 5v supply is at the top, right of the board with ground at the top and 5v at the bottom side of the terminal. The 12v supply is at the bottom, right of the board with ground at the top side of the terminal and 12v at the bottom.

I've run jumpers directly from the 12v supply to the ground and 12v power supply points on the 754410 rather than depending on the strips to carry that current. I also ran a jumper from the ground on the 12v supply to the ground on the 5v supply. I've still got to put a jumper to connect up the power and comms grounds.

With a little luck this board should allow me to get a NEMA 17 running without a lot of drama. Then I can work up to more complexity from there. :-)

STL files and polygons

Tuesday, 4th April 2006 by Adrian Bowyer

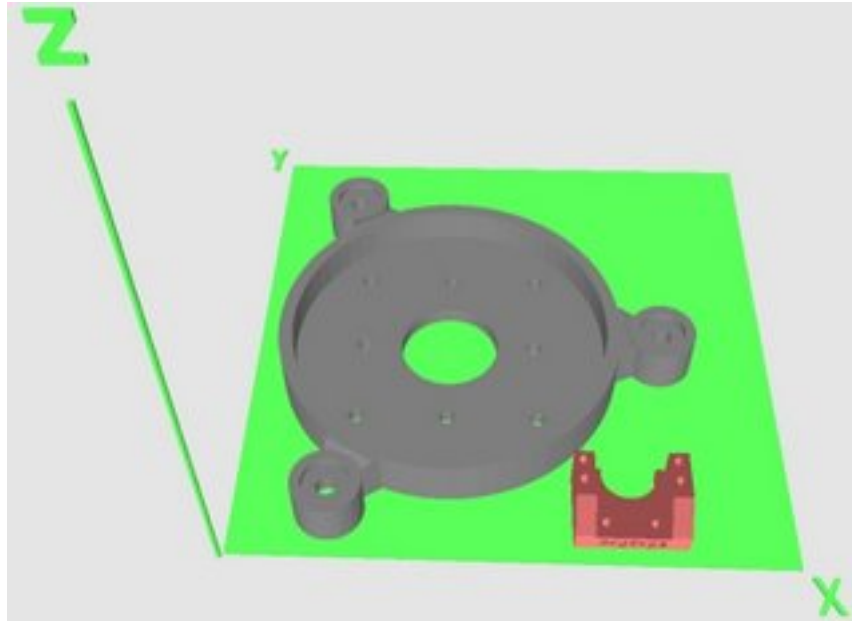

Thanks to [Daniel Selman's Java3d book](#) I have got a program working that will load STL files and allow one to zoom, pan and rotate them on the screen. It has a stylised view of the working volume of the RepRap machine (green), into which one can load objects to be made (Vik's spider - grey; and my extruder motor holder - pink). The working volume is represented by an STL file too, so we can make it look like anything we like (and animate bits of it if we really need to). The parts for manufacture are all grey at the start; the pink is just me testing if my code to pick them with the mouse works.

I now need to write the code that allows one to move the picked object about on the green square of the build-base to position it where you want it made, and to do collision detection to make sure objects don't touch.

I also have polygon infill working for laying down CAPA by the extrude head. One would outline a part slice with polymer extrudate, then offset that shape inwards by the width of the extrudate and hatch fill it like this (this is not one of the parts above):

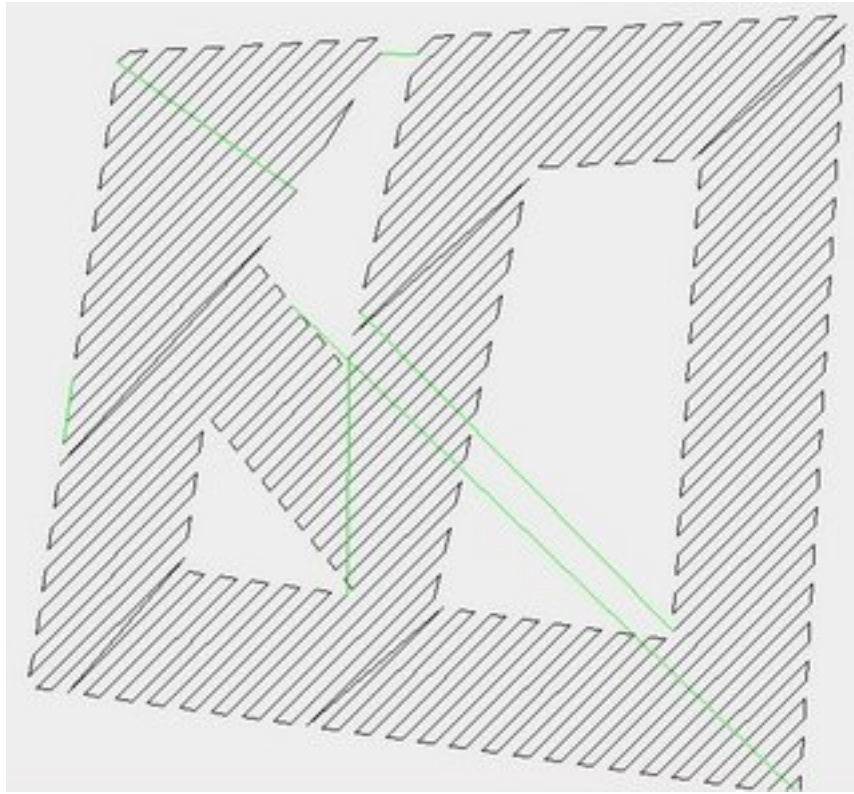

The black lines are fill; the green ones are jumps. The slightly odd diagonal lines between adjacent passes will go when I have the next stage working (they are caused by the algorithm's absolute refusal to put material where there should be air, even if it's within the tolerance of a surface).

I need to get set-regularization working for the polygons (lots of coincident surfaces get unioned when an object has vertical sides), then put the 3D stuff and the polygons together...

Still Life With Stepper Controller Board and Stepper Motor....

Saturday, 8th April 2006 by Forrest Higgs

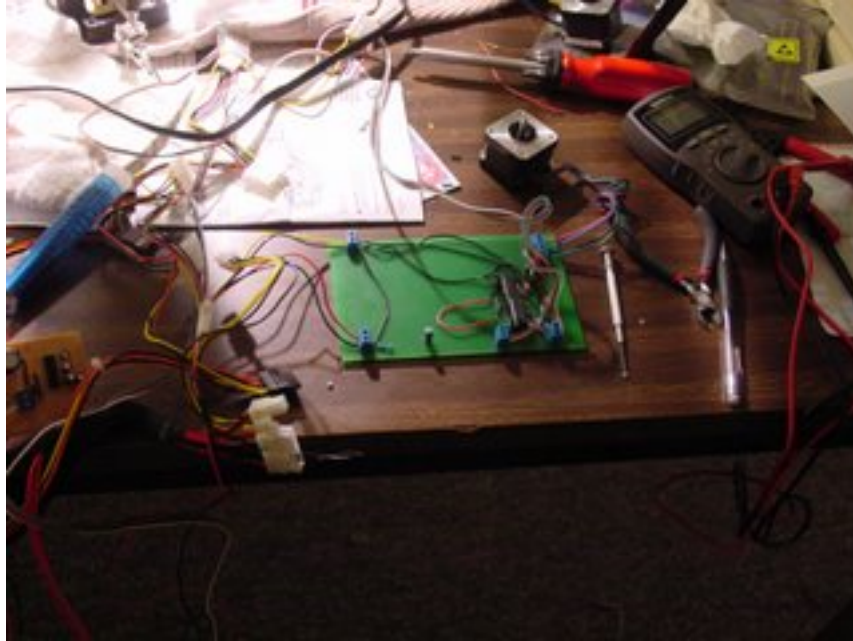

It works now...

After Simon published the debugging protocol in the wiki I decided that I had better regularise my handling of connections to the stepper motor. To that end I installed two screw terminals to handle the connections rather than the direct to motor soldering that I had done earlier.

I was a good boy and walked through Simon's test series for voltages before trying to run a stepper motor. Everything checked out perfectly with ~10.75v being sent to the stepper motor.

Just for luck I hooked up a different NEMA 17 than I had used earlier for the test. That stepper motor turned quite nicely. That SN754410 chip doesn't get half hot! You could cook breakfast on it! :-0

I tested the board for speed and direction and it seemed to respond perfectly.

After satisfying myself that the board worked properly, I swapped stepper motors for the old one. After doing that the whole system froze. It stayed frozen when I disconnected the stepper motor and restarted the exerciser programme. At that point I decided that hot swapping the stepper motors was a bad idea and that I must have fried the board doing that.

I disconnected the stepper board and hot wired the token ring on the comms board and still not

even that worked. Hyperterminal wouldn't even echo. It struck me that I couldn't have fried the comms board too so I crawled under my worktable and checked the serial connector and discovered that the pin 3 comms line had broken free.

I resoldered that and resolved to put a housing on the connector in the morning and then went back and checked out both the first and second stepper motors on the comms board after establishing that both comms board and the stepper board weren't misbehaving in any way.

Both ran nicely.

As hot as that SN754410 chip got I wonder about the sense of stacking them. It also strikes me that on a practical board they need to be spaced out away from the PIC16F628 and from each other and good heat sinks glued to them if we are going to run steppers driving a reprop for long periods of time.

Those are details, though. That's just tweaking, something that I am in a good position to do now that I have a working design. Many thanks go to Simon and Vik for the design and realisation of the bipolar stepper controller board and associated firmware. Well done, guys!

Customisable addresses etc

Saturday, 8th April 2006 by Simon McAuliffe

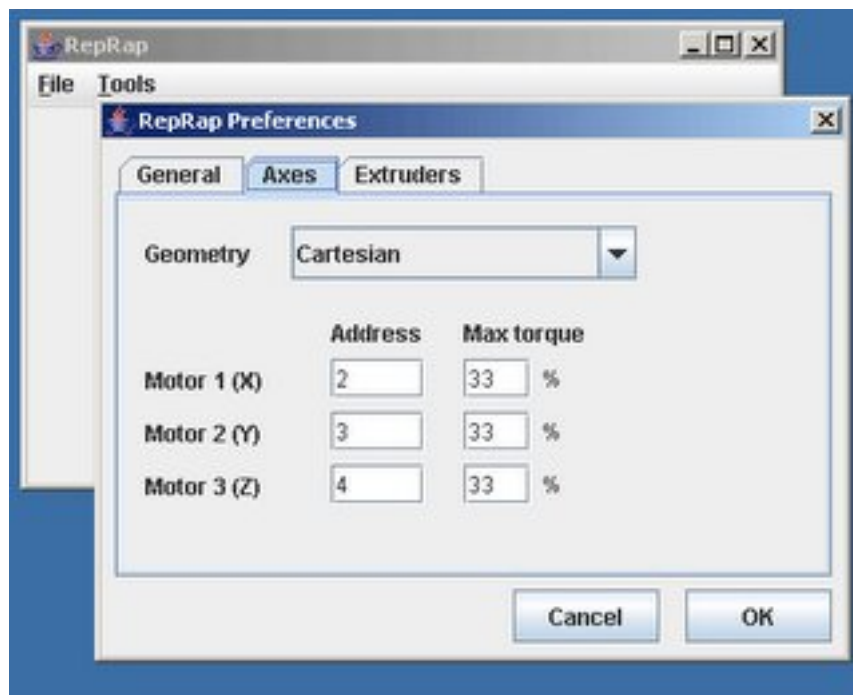

I have added a settings screen to the main RepRap application. This now lets you set addresses for each of the motors as well as the current limits. You can set the serial port in here too, so no need to edit properties files manually any more. It's kinda minimal but handy.

The next cool thing to do will be to integrate what Adrian is doing into the main app.

ARNIE Mk1 first build

Sunday, 9th April 2006 by eD

So this is what he looks like in the flesh!

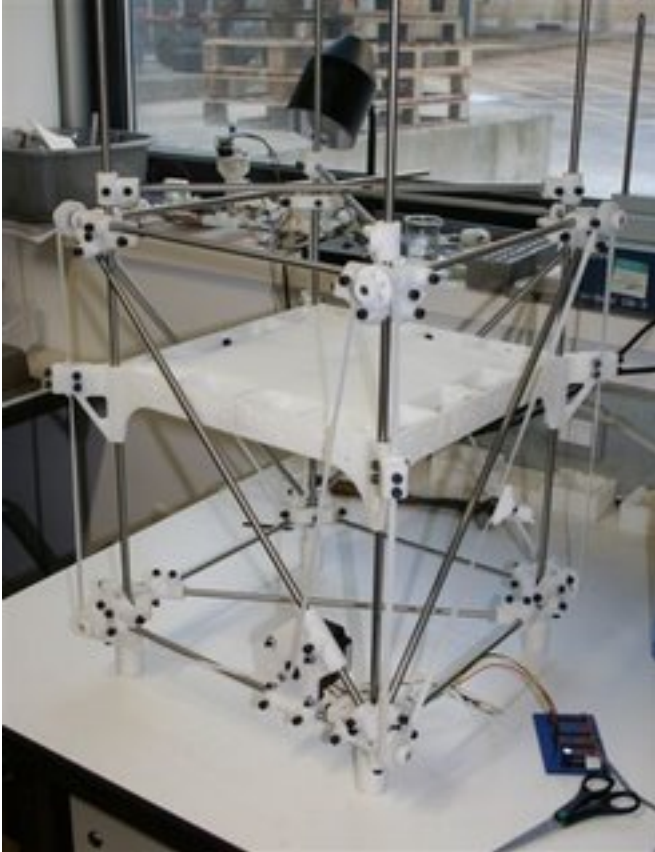

It's very satisfying to point out that everything white is RP. But annoying to note that he doesn't quite work yet. He'll go down beautifully. But not up. But that was the very first impatient test without bothering to align the bearings properly, so I'm keeping my well and truly fingers crossed for next week.

Stripboard extruder controller

Sunday, 9th April 2006 by Simon McAuliffe

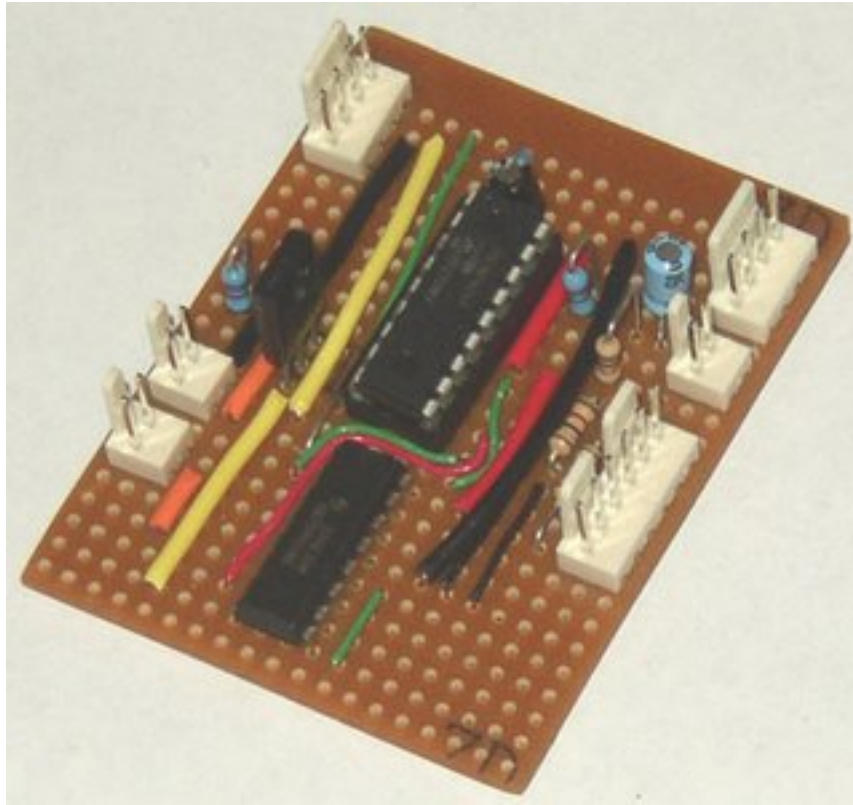

I thought I better build one of these since my previous versions have only been on breadboards. This is a slightly more compact layout than the one on the wiki (the variation is in CVS). It's probably better in general to stick to the larger design on the Wiki, but I'm fussy and don't like big boards.

All working nicely so far. Now that I have a real one I should do some more work on the Java drivers for it.

Stage now moving under Java control

Monday, 10th April 2006 by Vik Olliver

I've finally got my repaired PC to run javacomm and have got the stepper exerciser running. It just drives the stage module at the moment, though I plan to add the rest on tonight. This puts the hardware only a whisker away from being capable of producing a plotted circuit board, provided the hardware actually checks out.

The stepper driver being used is the ULN2803-based design, driving a unipolar stepper motor. I'll work on the updated instructions over Easter when I'm not allowed in the workshop...

The 754410-based extruder controller design is also communicating, and can control the motor and read values from the thermistor. A glitch in the driver code (possibly a compiler issue) is currently preventing the use of the heater controller, but as I have a working thermostat from the prototyping stage this is not a show-stopper.

Vik :v)

The Godzilla stepper controller board takes shape...

Friday, 14th April 2006 by Forrest Higgs

I got past a consulting deadline yesterday so after a good night's sleep I decided to kick back for a few hours and see if I could put together the "big board" stepper controller that I'd been thinking about. It's designed around a bus that runs across the centre of the board with the controller and comms connections in the upper right quadrant and the SN754410's in the other three quadrants.

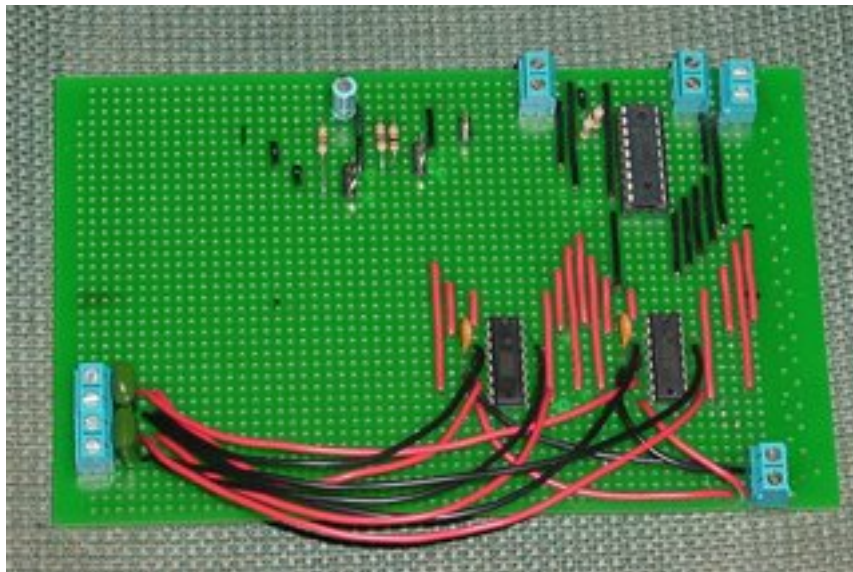

So far I've installed two of the Sn754410's to drive one of the NEMA 17's. I plan to debug the design before trying to install the other two.

RepRap Control Software

Sunday, 16th April 2006 by Adrian Bowyer

Simon and I are obviously thinking along the same lines, even though 12,000 km of molten rock and iron separate us...

I've just finished the first version of the RepRap front end that allows one to load and arrange STL files into the machine preparatory to building them. Here's a screenshot:

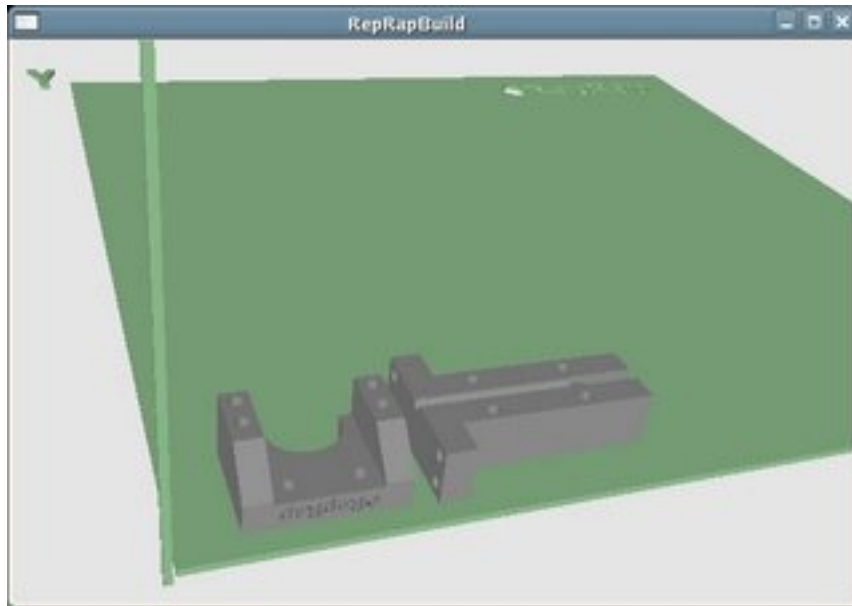

There are more details on the [RepRap wiki](#) here. The driver backend is being written, so when you ask the program to build the objects you've loaded it just gives an optimistic message at the moment. But I'd welcome comments on the look-and-feel.

Obviously Simon and I need to integrate his stuff described immediately below and this.

3D Progress Previewer

Sunday, 16th April 2006 by Simon McAuliffe

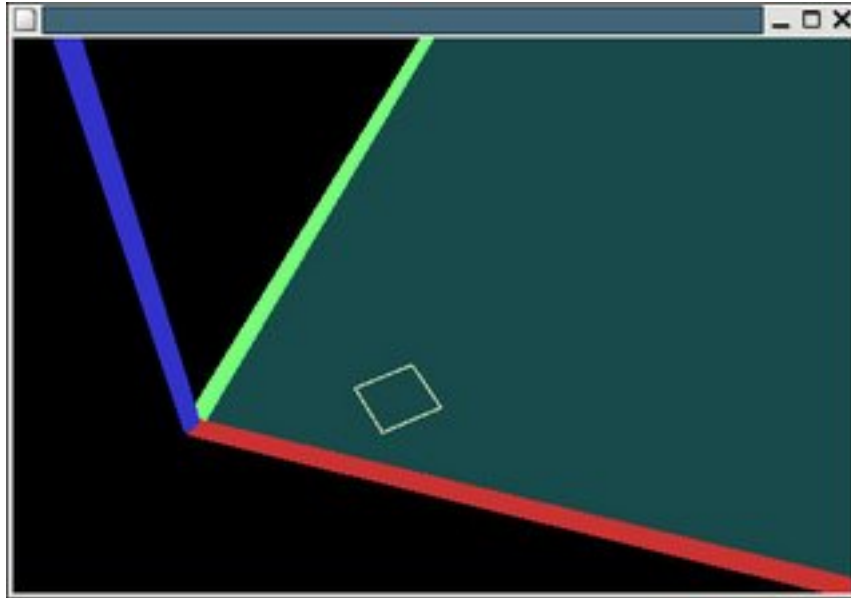

While sitting in front of bad TV tonight, I had a bit of a toy with Java 3D. It's not too awful, and I ended up building a 3D progress preview window.

This doesn't do anything that the component Adrian is working on does, it just shows you what is printing as it prints. You can rotate, zoom and pan around the object to see it is all going as expected. More usefully, if you edit the reprop.properties file and set the geometry to "nullcartesian" it creates a dummy reprop object. This means you can fully test things without a real reprop plugged in, and it's much faster. This should be really useful for debugging. Adrian, this might be quite useful for testing the stuff you're working on too.

It's very simple to use. Here's a complete application that produced the screenshot here. This is the same 7mm square as before, rotated 45 degrees.

```
package org.reprop;  
  
import org.reprop.gui.PreviewWindow;  
import org.reprop.machines.MachineFactory;  
  
public class SquareTest {  
  
    public static void main(String[] args) throws Exception {
```

```
Printer rerap = MachineFactory.create();

// Comment out the following three
// lines if you don't have java3d or don't want to preview
PreviewWindow preview = new PreviewWindow();
preview.setVisible(true);
reprap.setPreviewer(preview);

reprap.calibrate();
reprap.selectMaterial(0);
reprap.setSpeed(248);
reprap.setExtruderSpeed(180);

// Print a square, rotated 45 degrees
reprap.moveTo(20, 5, 0);
reprap.printTo(15, 10, 0);
reprap.printTo(20, 15, 0);
reprap.printTo(25, 10, 0);
reprap.printTo(20, 5, 0);

reprap.terminate();
}
}
```

RepRap application

Tuesday, 18th April 2006 by Simon McAuliffe

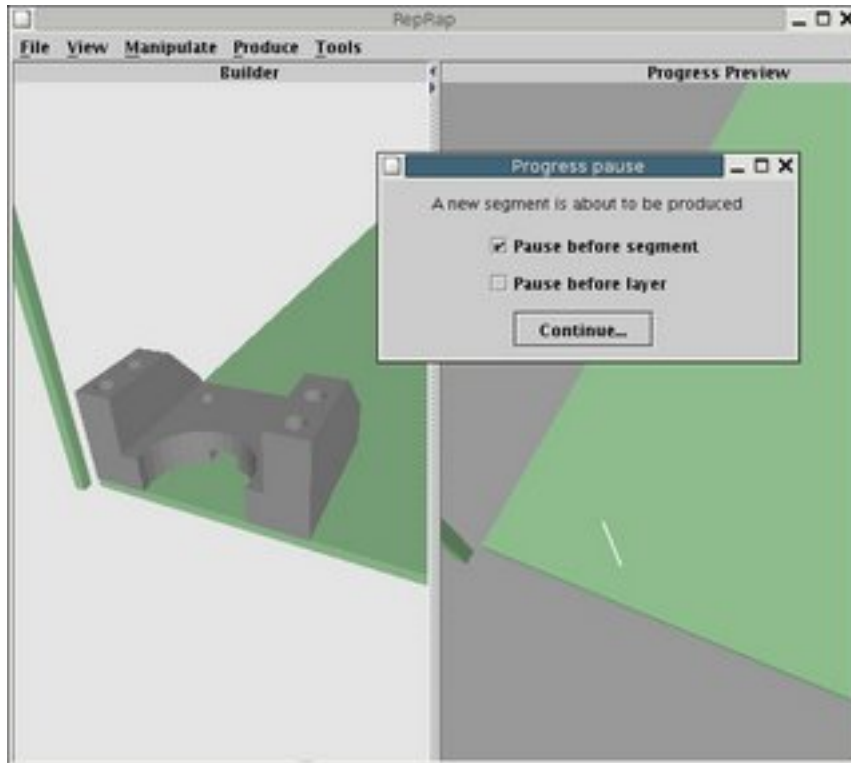

Adrian and I made some inroads towards merging bits of code.

This is the current RepRap application, showing both the construction view and the production progress window. The progress area optionally allows you pause the process so you can inspect what is being printed. Throughout this time, both panels can still be fully manipulated and inspected.

What's especially fun about this is that it is all talking to the hardware now too, so you can watch the motors whirling away, changing direction, etc. as the model builds up. If only I had a frame to put it all on :)

Without the hardware installed, you can select the null device in the preferences screen and still emulate the process.

There's still plenty to do of course. As you can see, what is being produced on that screen doesn't actually match the scene on the left, and that's some of the magic that Adrian is part way through.

It drew a square for real!

Sunday, 23rd April 2006 by Vik Olliver

My, how quickly I've fallen back into the swing of things after my holiday. By dangling a pen over paper on the Da Witch prototype's stage, the RepRap is now producing squares, octagons and whathaveyou quite happily and repeatably in 2D. The pen lines go over one another without deviating, so relative accuracy appears good even if absolute accuracy might need a little in the way of callibration. No photos - you know what squares look like :)

Da Witch currently consists of 3 screw-driven linear axis assemblies all made from FDM-fabricated parts: Long horizontal, vertical and a horizontal stage - no Meccano anymore. These are all driven by unipolar steppers, using a mix of 2803 and 2559 driver boards. Due to the modularity of design, this should work just as well with the bipolar motors and 754410 driver boards - Simon plans to put a stage or two together based on those over the next week or so.

I've used "poke" scripts so far as this gives a lot of debug output when prototyping, but I will now concentrate on getting the Java code going on my setup. Once the SDCC problem in the extruder firmware is sorted, we should be up to actually making something for real. Yeah!

Vik :v)

Extruder updates

Monday, 24th April 2006 by Simon McAuliffe

Oh, did I mention the extruder firmware problem is fixed? :) It was actually a wiring problem in my electronics, but I have discovered several other issues that I have fixed and committed.

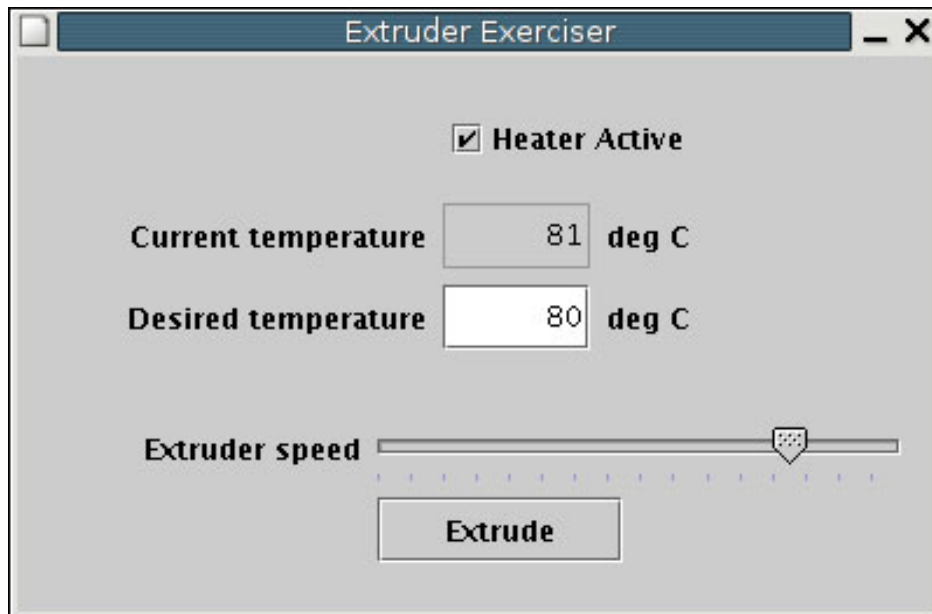

I have also committed to CVS some more work on the java drivers for the extruder. There is also a test application for extruders that you can access from the Tools menu of the RepRap application. It lets you specify a temperature and the extruder will automatically maintain that temperature. You can also drive the extruder motor.

The PIC firmware supports both "chop-chop" and dynamic heating. Chop-chop heating results in a temperature that wobbles around the target temperature while dynamic heating gives much more precise and stable heating. Currently the Java code only supports the chop-chop heating because it's a bit simpler. You need a little bit of a thermal model to make the dynamic heating work properly, so we can get to that later. The chop-chop heating doesn't seem too terrible anyway judging from my experiments with it today.

There are new preferences settings for specifying the two thermistor parameters that are needed to determine the thermistor temperature. I have also put a page on the Wiki that describes how to measure the parameters for a thermistor if they are unknown (as mine were) and how to calculate the other figure needed for the RepRap preferences (R at 0C). For more, see <http://reprapdoc.voodoo.co.nz/bin/view/Main/MeasuringThermistorBeta>

Godzilla y-axis tower moves...

Wednesday, 26th April 2006 by Forrest Higgs

A little while ago I took a break from training neural networks to fiddle with Godzilla. I seem to be having a good day in creating ad hoc ways to make things work. A scrap of poplar wood, a C-clamp and a piece of duct tape made a workable drive nut housing for the y-axis (vertical) tower being positioned by the z-axis.

At a controller set point of 240 the tower moves very smoothly at 0.6 mm/sec with the single 754410 controller board that Simon designed. It needs to be moving 7 times faster than that for the Mk II Extruder, but never mind for now... as Galileo said, "But it does move!" :-D

The z-axis in Godzilla has far and away the highest torque requirement in the design so it looks like the NEMA 17's are going to be adequate for running Godzilla. That's a major relief!

Godzilla z-axis turns properly...

Wednesday, 26th April 2006 by Forrest Higgs

I haven't had time in some days to work at debugging the bigger NEMA 17 controller board prototype due to pressure of billable hour work.

That said, my sister was dropping by this morning and hadn't seen a NEMA 17 actually running so I cranked up the single 754410 chip board and set it to running for her. No problems.

After she left, I left it on. After a while it developed a bit of a whine with a period of about a second. It was laying on my worktable and vibrating, no big deal. The NEMA was near the back end of the z-axis stage where the threaded drive rod protrudes so I idly just let the coupling that I'd made some time ago just thread itself onto the rod and begin to turn it. At a setting of 250 (just over 1 rps) it happily turned the rod while I held the motor in my hand... for a while until the bearings got out of alignment. I tightened the bearings onto the rod and noticed that the motor nestled nicely onto the baseboard of the housing for the rear of the z-axis and at a setting of 240 ran the drive rod happily.

What I had was what amounted to a floating motor mount, something that I've been trying to design in my head for the better part of a month. The drive rod alignment is determined by the lock nuts set on the bearings. I'd been trying to create a rigid stepper mounting system and, because of my crude fabrication capabilities with the hand tools I have wasn't able to get the tolerances close enough to make things work properly.

Turns out that I didn't need close tolerances. :-D

The NEMA has about 2 degrees float in the motor mounting. With the 24 threads/inch drive rods that I'm using that means that the motor float introduces about .005 mm of periodic inaccuracy into z-axis

I think that I can live with that. :-)

I tested the thrust that the NEMA put into the drive rod by hanging onto one of the nuts I'd threaded onto it. It appears that there should be enough thrust to move the vertical y-axis stage back and forth across the work table.

I think that if I shim the threaded drive rod into the bearings with some electrical tape I should be able to get rid of most of the 2 degree float. The holes in the 3/8-in bearings are slightly bigger than 3/8-inch.

I'll try to see if I can kluge up a housing on the y-axis stage to hold the z-axis thrust nut this

evening. Wish me luck.

Full translation on the z-axis...

Thursday, 27th April 2006 by Forrest Higgs

I ran one of the z-axes on Godzilla for it's full range of motion, approximately 660 mm. Not as smooth or fast as I'd like, but I think I can tweak that for better performance without a lot of trouble.

Now that I have it working after a fashion some of the weight loss ideas I had for the system a few months back when I was doing design charrettes came back to me.

First off, if we fixed the threaded rod and rotated the thrust collar (nut) we could lose both the bearings and the inertia of turning the whole rod. I suspect that that would greatly reduce the torque required to move the vertical y-axis tower.

Second, if we used a cheap metal ruler on one of the z-axis stages to provide lateral stability for the y-axis towers we could lose about 75-80% of the volume of polymer needed to produce Godzilla's z-axes.

Similarly, if we used a couple of cheap metal rulers held together with rebrapped clips and mountings we could provide for both lateral and vertical stability on the x-axis that is suspended between the two y-axis towers. That would drop about 75-80% of the volume of polymer needed in the x-axis.

If I went in that direction the replication time for Godzilla would drop by well over half.

More work with the z-axis

Sunday, 30th April 2006 by Forrest Higgs

Simon spent a bunch of time with me this afternoon getting his java stepper exerciser code working on Godzilla. It's a lot nicer than the old exerciser, loads more torque from the stepper and adjustable, too.

As mentioned in the documentation the slider for stepper speed is VERY nonlinear. From 0-240 you go up to about 1 rps. For every step above about 250 though, the stepper tries to get a LOT faster. It's kind of sad because the speeds we'd like to use run from 250-255, which means we don't have a lot of resolution. :-(

And here by popular request, boys and girls...

Friday, 12th May 2006 by Forrest Higgs

is your involute gear profile routine...

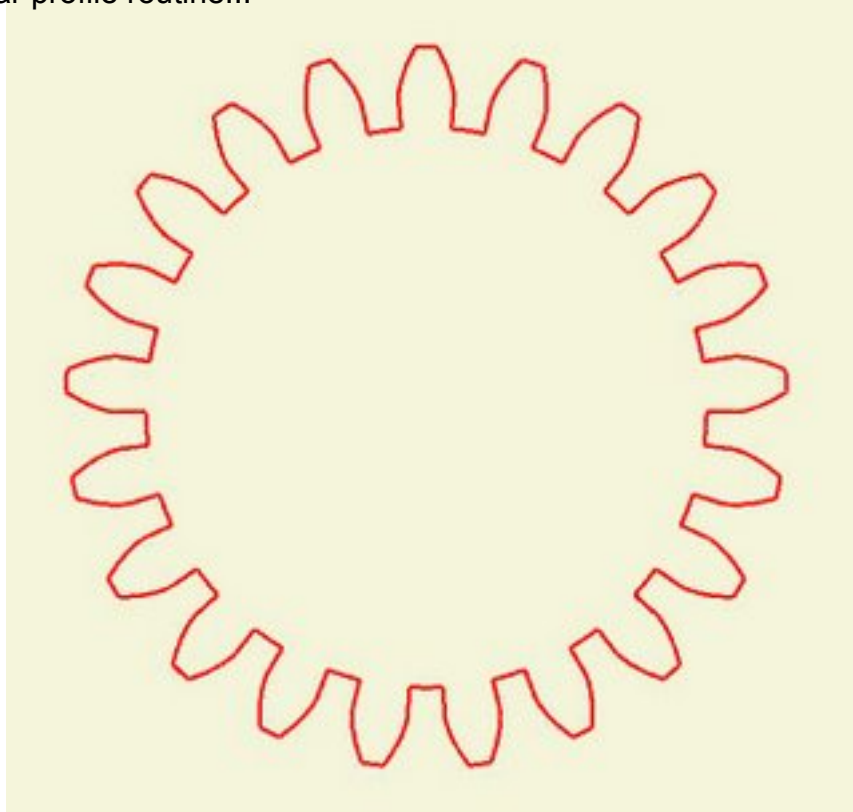

I had forgotten how finicky a business it is to create a rectangular to cylindrical coordinates conversion routine that uses the arctangent function that's good for all four quadrants of a 360 degree range. That took an interminable amount of time... all special cases. :-s

I didn't add fillets and roundings, mostly because for the size teeth we've been talking about, viz, 3 mm or so, I doubt that our reprints will even see that sized detail. I also used straight lines for the base between teeth and the tooth crowns for the same reason. If this proves to be a problem I'll expand the code. I'd rather not get caught up in guilding lilly exercises just now. I just want to make a drive train.

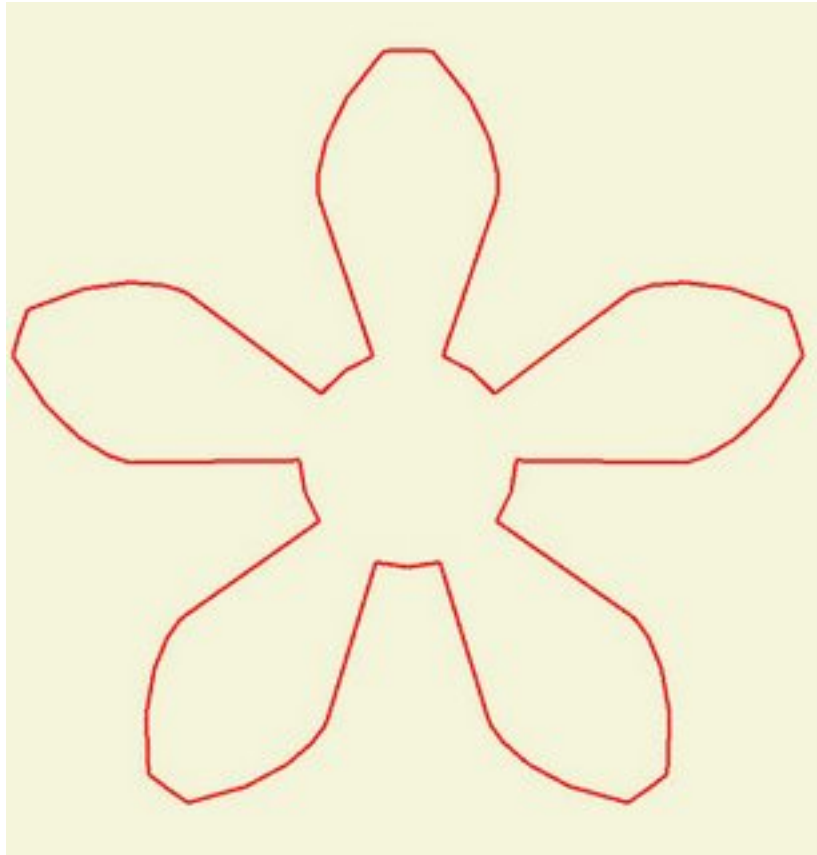

It's always fun to push design methods to extremes. This one from the University of Luleå that I've pirated for our purposes to design involute profile gears gives some really neat results at extremes as you can see with this 5 toothed gear. If we were really going to make gears at the extremes then fillets and rounds would be much more likely to be required. As it is, though... :-)

There's a contract final report to write up and turn in in the morning along with an invoice so I won't be getting back to this till tomorrow afternoon or evening. I'll be trying to sort out the design process so that we can make gears that mesh properly with less effort than is presently the case. If that works I'll clean up the code logic and try to translate this into Java this weekend. I've got Vik's excellently written cog script as a starting point, so I'm not expecting a lot of problem with that. Wish me luck, though, after all I didn't think that doing a simple cylindrical to rectangular coordinates conversion was going to be such a big deal beforehand, either. :-)

Time for a laugh, and a smile

Saturday, 13th May 2006 by Vik Olliver

I've had my first bash at the Produce test that Simon has written, using some actual hardware that has miraculously behaved long enough. This revealed a few interesting things, like my Y axis is half the scale of the X, my X axis is actually reversed, and that the best substrate so far seems to be a piece of paper.

So, how about a picture:



Yeah, I know. Not a lot like a hexagon and a square - except in post-LSD nightmares. I'll give you a couple of clues: The hexagon is bigger than the square, and they're the wrong way round because of my X axis inversion. Also too short because of my Y axis mis-scale. Also very mucked up because the infil is meant for a smaller nozzle. Also the first time anyone has done this...

Vik :v)

Something that looks like square and hexagon!

Sunday, 14th May 2006 by Vik Olliver

OK, now you decide. Can you tell which is the square and which is the hexagon?



There are 3 layers, roughly a whopping 0.5mm thick. The Z-axis was handled manually between layers, otherwise it was completely automated. The nozzle was the same huge 1.5mm worm-squirting monstrosity (about 0.5mm dia) as last time. There is video if anyone is interested.

The first edge of the square failed to extrude every time, which we'll have to deal with when we start calibrating things. But for a first-off attempt with next to no anti-backlash and zero calibration I'm pretty pleased. I think we're on to a winner here.

Brandy and hot bath time :)

Vik :v)

Busy weeked with little to show

Sunday, 14th May 2006 by Simon McAuliffe

I had a pretty busy weekend. I managed to:

- * Progress the virtual comms and testing infrastructure (see svn branch), which will soon allow me to complete the remainder of the comms infrastructure. This will eliminate those occasional pesky errors.
- * Updated my old graycode wheel perl script and put it into the reprop subversion repository. See reprop/misc/graycode in subversion.
- * Using new graycode script, produced a template for a bi-directional position sensor for a DC motor controller.
- * Tried out my previously imaginary process for turning PC artwork into plastic objects, pre-reprop. Potentially a useful process for "restrapping" with kitchen level technology.
- * Some work on reprop application to eliminate most of the hard coded magic values and make them customisable via the preferences screen.
- * Tested my old thermoplastic bushing idea for my old reprop design. Mixed success. It fits so perfectly that it doesn't turn very easily, but it certainly removes any play in the threaded rod. Needs more work...



This is what my 2-bit graycode bi-directional position sensor currently looks like. It's so simple it could just as easily have been created by hand, but using the script allows for very simple changes to diameter, spacings, etc. In fact, these are the parameters for the graycode script. It's fairly versatile:

- * Number of bits (arbitrary number)
- * Wheel dimension (mm)
- * Inner dimension (mm)
- * Strut size (mm)
- * Span (degrees). For angle sensors, it's often useful to use less than the full 360 degrees.

- * Stagger (~mm). Stagger between sensor positions. This allows bulkier sensors to be used and the graycode rings are offset. The application also produces a cutting/placement guide that should where the sensors should be placed, which is pretty essential when staggering.
- * Resolution (dpi)
- * Portion. Fraction of wheel to include (entire wheel is not necessary if used for angle measurement and using less than 360 degree span)
- * Repeats. The number of repeats of the graycode pattern around the wheel. This is the new feature needed to make a mechanically balanced wheel for a fast turning position encoder.

I started to add STL support a while back, but that's not even close to complete. The primary output is a bitmap ready for printing on a laser printer.

My conceptual process to turn these into actual plastic objects was:

1. Print out object onto tracing paper with a good laser printer (new toner). Inkjets don't work as the inks are UV transparent.
2. Take a piece of thin steel, and spray it with PCB photo-resist. Bake dry for impatient people like me.
3. Place tracing paper pattern on metal. Cover with thin sheet of transparent plastic (not glass which is UV opaque) to hold pattern close to surface. I used the plastic from a CD cover, whatever that is.
4. Blast with UV light
5. Use developer to bring out the pattern on the metal
6. Using electrolysis, "melt" away the unprotected part of the pattern, leaving a thin metal version of the pattern. Alternatively use copper sheet, and use ferric chloride to remove unwanted metal.
7. Press metal pattern into molding plasticine. Pressing it deeper makes a wider part.
8. Create plaster of paris mold from plasticine and let it dry.
9. Melt plastic into mold

My goal was to produce one of the gray code sensor wheels and Forrest's sample involute gear pattern.

I tested steps 1-5 but it seems my photo-resist is a bit too old now. In fact it's quite a few years beyond it's "best by" date, so it's time to order some more. The patterns were not holding well enough for me to carry out the remainder of the steps. I will try again when I get some more photo resist, but all the local suppliers seem to have stopped selling it. I'll try RS.

I tested step 6 using several different electrolytes. Plain salt (NaCl) was the fastest but has the downside that it produces some chlorine gas, so ventilation is a good idea. It doesn't need much salt though. I hand painted a pattern onto a piece of metal, and the pattern was cut out with good fidelity. It takes quite a few hours to cut, so you have to have some patience. It makes the more conventional ferric chloride approach more appealing if I find or make some plain copper sheet. I

have lots of ferric chloride, so I might try that next time. The electrolysis approach produces nice steel templates and just seemed cooler :)

I have previously tested steps 7 to 9 using PLA to produce some gears. It works quite nicely but destroys the plaster mold so it can only be used once. It also takes a bit of scraping to get excess plaster off the gear before it will work nicely.

So all steps tested, but not quite working yet.

The solution to yesterday's puzzle

Sunday, 14th May 2006 by Vik Olliver

So I figured the machine may be having difficulties and put a pen plotter back on. The plotter has 0.5mm play in it which I've not been bothered to fix, but this picture shows fairly clearly how Simon has helped me fix up the axes:

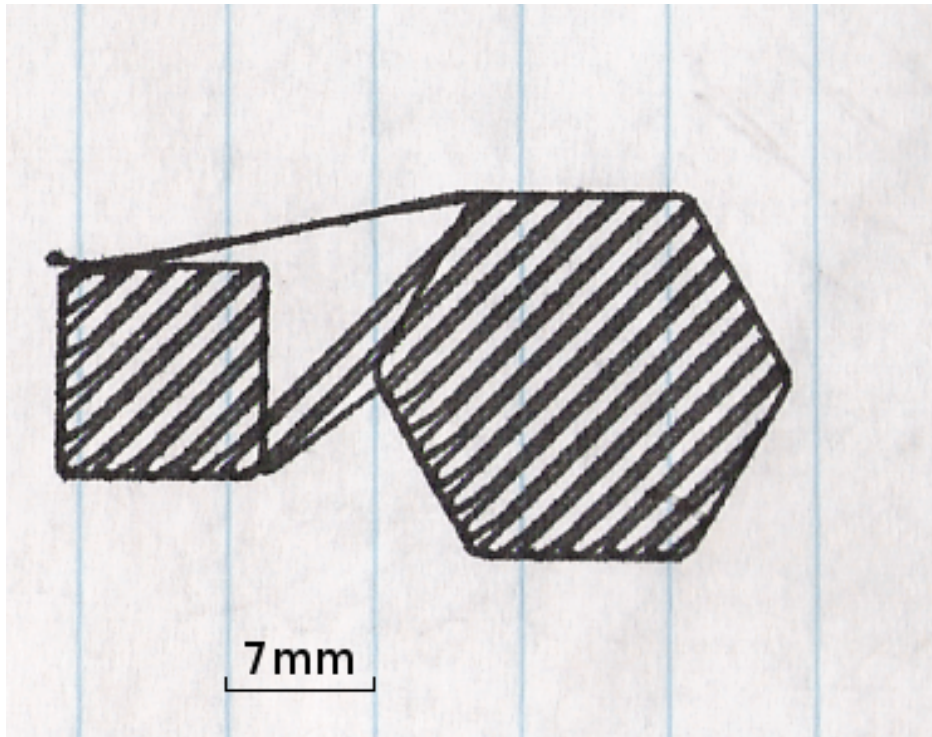

So that's what it should look like! :)

I had a break in one of my 12V power tracks (reinforce them all with solder, boys and girls) and a stepper moving too fast. The combination of those two produced yesterday's "Blobs From The Dark Lagoon". I think I still have my Y-axis reversed.

I guess all that's left to do now is roll some more CAPA and have another go at extruding. We'll see how far I get tonight.

Vik :v)

Limits on the gear script not as bad as thought...

Monday, 15th May 2006 by Forrest Higgs

Turns out I'd managed to corrupt Aol or Java or both while I was writing the script.

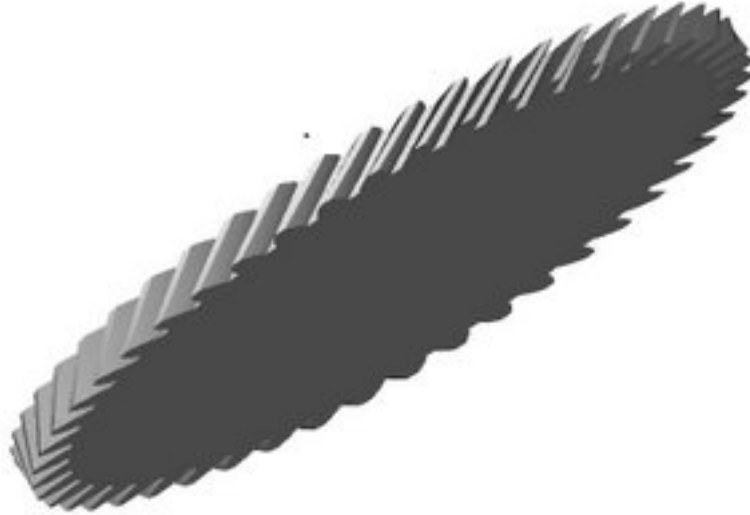

I reinstalled both and I can now generate at least 48 tooth gears and helical at that.

I then decided to see if I could double that tooth count, so I went to 96 teeth and dropped the pitch angle to 14.5 degrees so that we didn't get weirdness in the profile.

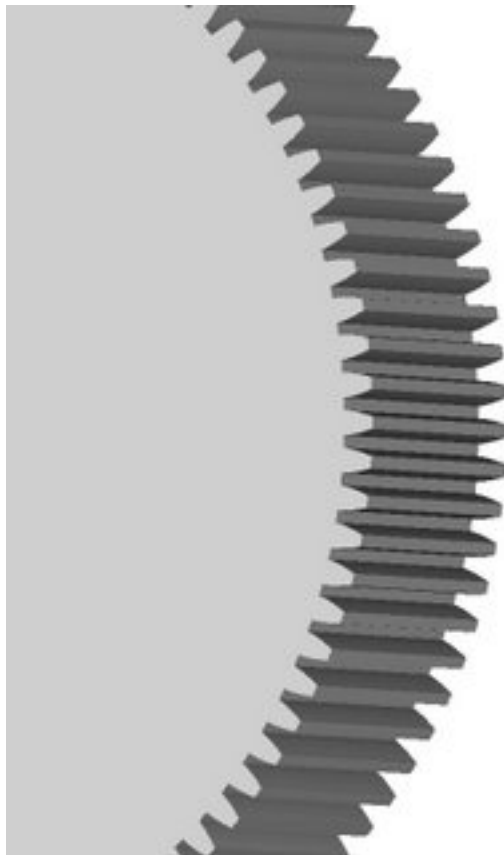

That worked fine, too. I pushed it again to 128 but at that point the triangular mesh feature wouldn't turn the profile into a surface for me.

At 96 teeth you're talking about a 180 mm diameter gear if we are to keep the teeth at 3 mm. That's pretty big.

It's slow, but it works. :-)

Thoughts on scaleable RepRaps...

Monday, 15th May 2006 by Forrest Higgs

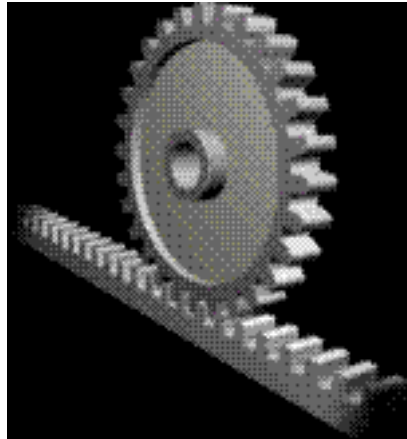

Now that we can make involute profile gears, why don't we make racks to go with them?

If you split the rack lengthwise and made it in sections of maybe 200 mm it would be relatively easy to design a sliding dovetail connection so that two lengths could be assembled to make one rack twice as wide. Stagger these sections and you could make a rack as long as you desired from 200 mm sections.

Put holes in the sections that were a little wider than the bolt that went through them. Reprint an alignment template jig so that you could hold the two halves together while you secured them with nuts, bolts and lock washers and you are good to go.

Lay a printed linear encoder strip beside your rack and you have a track that a positioning stage can use.

A bunch of things have been bothering me lately. We've got good control boards for steppers and we've got good steppers with magnificent angular resolution. Unfortunately, stepper torque drops like a stone when you try to run them quickly. We stick these onto threaded rod drives like we see our CNC hobbyist friends using. These guys are running their systems very slowly because they are doing things like cutting patterns in a piece of wood with a router. When you are doing that sort of thing speed is not what you want, so steppers work magnificently.

We're not taking away material, though. We're laying it down. Our productivity depends on how fast we can extrude material. The Mk II extruder currently operates at 4 mm/sec. At a 50% duty cycle it will put down 1 kg of polymer/month. We need to be doing five times that to have a viable system. The current Mk II technology can probably be pushed into doing that by putting more energy into the extruder head and amping up the feed.

Our current positioning stages are more of a problem, however. We can do about 1 rps with our

steppers. Using threaded rod positioning systems that means we can move about 1 mm/sec. If we try to go a lot faster than that our torque goes away. We need to be doing twenty times that.

The problem isn't with our control theory or with the steppers. Those are fine. The problem is the use of threaded rods for positioning. Threaded rods are fine for the vertical axis. Speed isn't an issue there. For the horizontal axes, however, they don't work all that well.

Why not rack and pinion?

Most of the CNC equipment that I've seen uses rack and pinion. If we were to use our existing steppers to drive rack and pinion positioning we could get the speed we need without a lot of drama and without trying to make our control boards do things they were never intended to do.

We're not trying to carve anything so our positioning systems can be light. Ed's string machine had a lot going for it in terms of using the method for keeping things aligned while applying force asymmetrically. I think where the trouble began is when he tried to apply motive force to the cables. In Godzilla it would be relatively easy to use drafting board cable and pulley technology to reduce the number of steppers needed and the complexity of the control system.

Now that I can design gears I'm probably just seeing everything as problems with gear problems.
:-p

Meshing gears... Simon's question...

Monday, 15th May 2006 by Forrest Higgs

Can we produce gears of different sizes that still mesh correctly with each other?

I think so. This routine figures the tooth placement from the pitch radius which, if I understand it correctly, is the place where the teeth of meshing gears interact.

What you do is decide on a pitch radius, say 130 mm and 13 teeth. Then you if you wanted a 13:6 gear ratio you'd go for 60 mm and 6 teeth.

I did that and then placed the two gear centers 60 mm + 130 mm away from each other. As you can see they mesh very nicely.

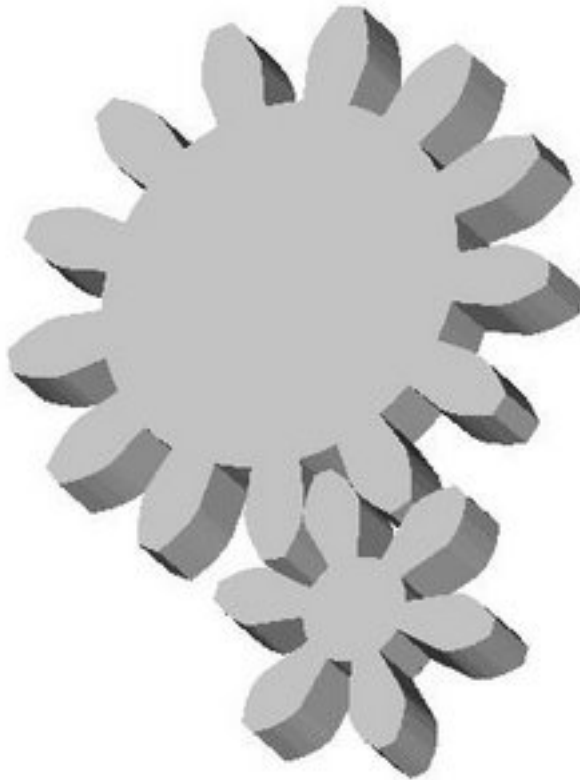

Okay, Simon! Make us some gears! :-D

Here's a gear pair with a 24:11 ratio. It took me about a minute to design it on Art of Illusion.

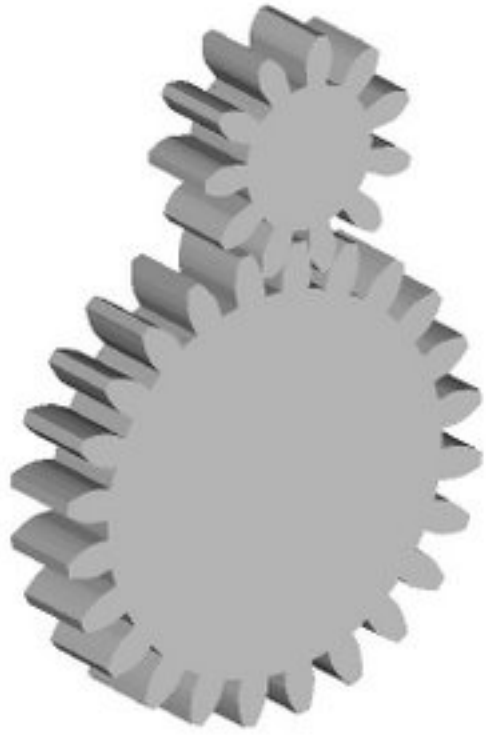

Heh, heh, heh... :-D
Monday, 15th May 2006 by Forrest Higgs



We have an involute gear script!

Monday, 15th May 2006 by Forrest Higgs

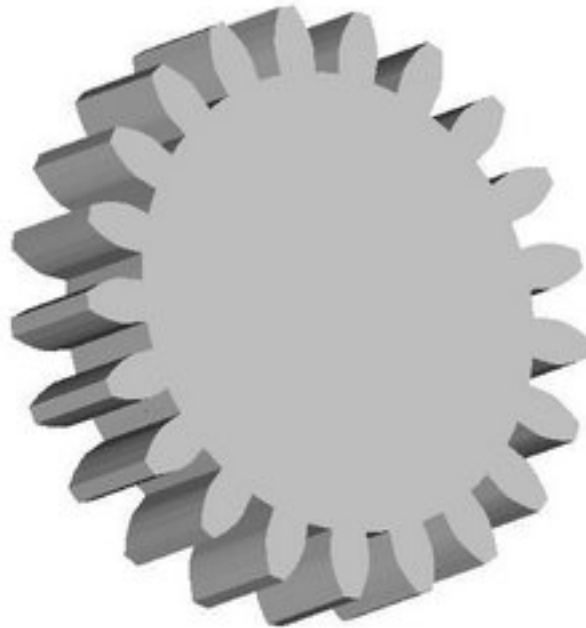

Just got past the last peculiarity of the Beanshells scripting language and the gear profile displays. It would have never been possible without Vik's cog script as a starting point and his advice at critical moments. I'll be passing copies of the script around to the team as soon as I do a little code cleaning on it.

Gear reduction...

Tuesday, 16th May 2006 by Forrest Higgs

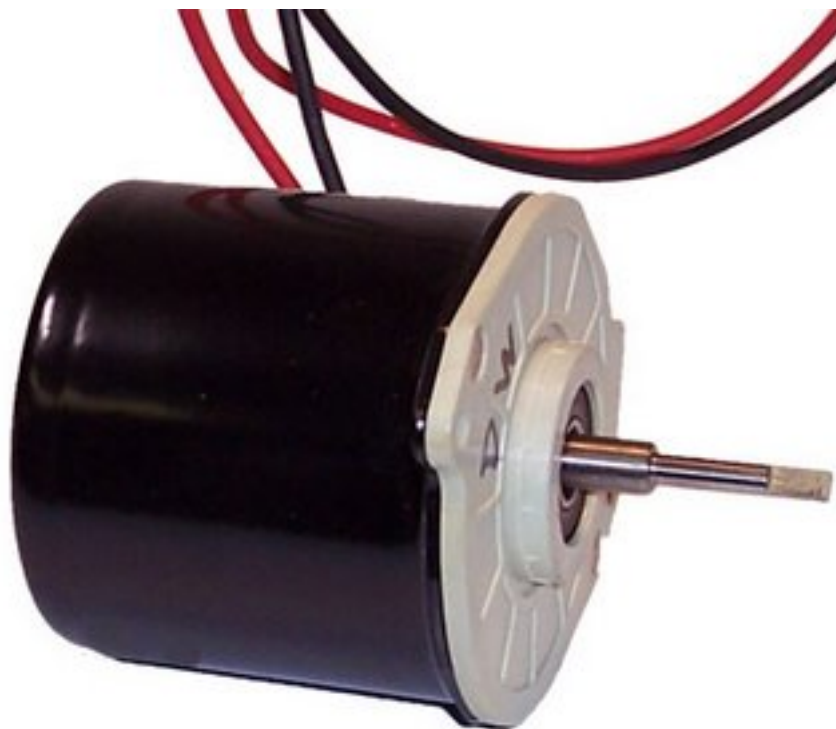
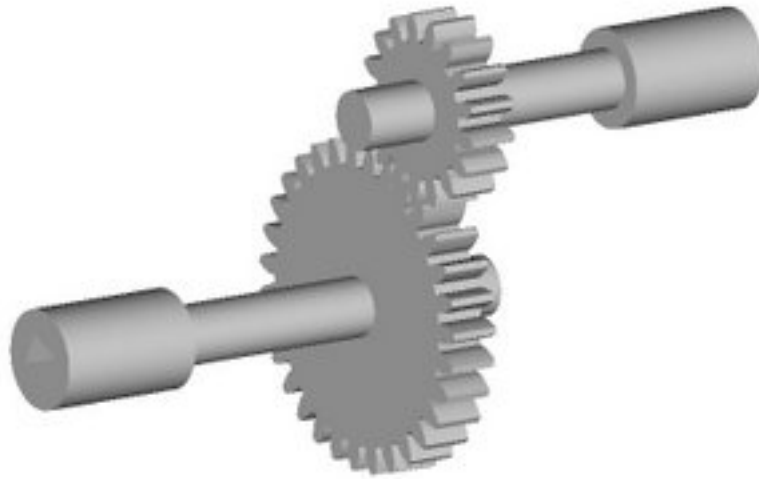

After thinking about it for a while, I bought five of these to see if I can go at it more efficiently from high rpm to low. The MECI people had a 20% off sale on this month so I got 'em for US\$4.76/unit.

That 1.8:1 reduction should make for a lot less hours on the Stratasys. :-)

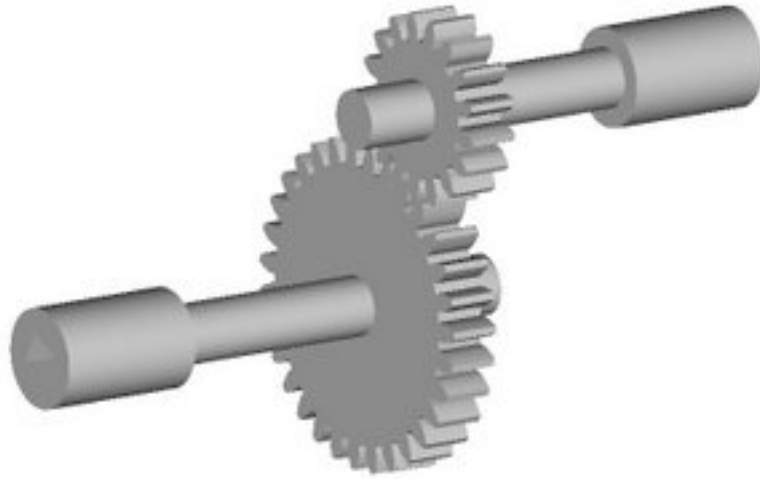

A 31:17 toothed gear train for it looks quite reasonable.

And some gears not so good

Tuesday, 16th May 2006 by Vik Olliver

With an enormous "Kerrrapppp!" I stripped the gearbox on my extruder. When assembling it, I managed to push the drive shaft into the gearbox a little too far without noticing. The last gear was then only half aligned with the previous gear, and when I powered it up it ripped half the teeth off. Bugger, as we say in New Zealand.

So, next attempt will involve reformatting a Black & Decker 6V electric screwdriver - my rechargeable DSE screwdriver is far too nice to sacrifice :) Simon reckons it'll do well if the PWM output on the extruder is set to 50% but holding it in place is going to be interesting.

Still, lesson for Forrest on gears - make 'em wide and strong as the ratio increases!

Vik :v)

A gearbox for Godzilla...

Tuesday, 16th May 2006 by Forrest Higgs

Some weeks ago it became obvious that Vik and Simon were going to get Vik's RepRap going at version 0.1. More importantly, it also became obvious that there was enough internal friction in the Godzilla RepRap as designed to make use of the NEMA 17's to run it at anything resembling a decent speed was pretty far down the track. Indeed, NEMA steppers driving threaded drive rods for horizontal positioning began to appear quite a dicey proposition. That's what I call a learning experience. :-)

Plainly, if I was going to keep the Godzilla design concept I had to have much more torque available at much higher rotational speeds. Some time ago I had acquired a pair of Siemens gearmotors designed to operate automobile electric windows. Those work on 12v power and have loads of torque.

Yesterday, I drove the Godzilla z-axis with one of them at 12v and today I ran it at 5v. There is no lack of torque. At 12v the Siemens gearmotor gets 56 rpm. That drives the z-axis at just under 1 mm/sec. The Mark II Extruder is designed for 4 mm/sec and I'd like to think that it can be pushed to 20 mm/sec without a major change in design philosophy. The design problem, then, is to leverage the Siemens gearmotor into getting 4 mm/sec and 20 mm/sec if at all possible out of the Siemens.

The obvious way to get that to happen is with a gearbox. Last week, at Simon's prompting, I wrote a script to design proper (involute profile) gears. That done, this week I've set about to design a proper gearbox for the Siemens.

My first design decision was to use a gear train rather than a simple pair of gears. This was more for space considerations than anything. It also conserves material in that going from 56 rpm to just over 1,300 rpm in one stage requires a rather enormous gear and puts some tremendous stress on the gear driving the threaded drive rod for the positioning stage.

I wanted to keep a constant gear ratio throughout the train to reduce complexity. Eventually, I arrived at a ratio of about 2.8:1. Assuming that the Siemens without a gear box can drive the z-axis stage at about 1 mm/sec, the resultant velocities at each stage of the gear train look like this...

Stage 0 - 1 mm/sec (56 rpm)

Stage 1 - 2.83 mm/sec (160 rpm)

Stage 2 - 7.8 mm/sec (440 rpm) {range needed for the Mk II Extruder}

Stage 3 - 22 mm/sec (1,230 rpm) {range needed for the expected terminal performance of the Mk II}

With that in mind after I got the gear design script running I started making some choices about tooth counts for the gear pair. Interestingly, using Adrian's rule of thumb that gear teeth need to be about 3 mm wide at a minimum it is very easy to use the script with that in mind. For example, if you need 24 teeth in a gear making the pitch radius 24 mm gets you a tooth width of just over 3 mm. Pi is a wonderful thing. :-D

Anyhow, keeping Vik's advice about tooth counts in his tutorial in mind I arrived at a tentative gear pair with 31 teeth in the drive gear and 11 in the receiver. With that in mind I began a design charrette to see how the bits could go together. I decided to make a first shot at two stages so that I could run it at the Mk II's capacity with the option to add another a bit later. Here's what I got on the first cut...

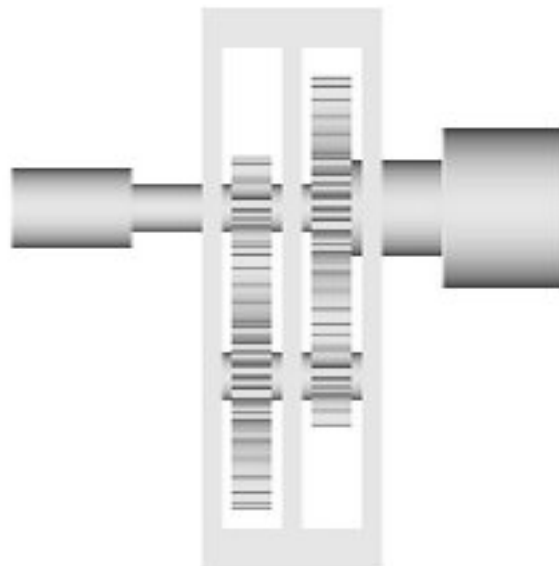

You can see the coupling for the Siemens gear motor on the right and the coupling for the threaded drive rod on the left.

To give you an idea of scale the coupling collar on the right is 40 mm in diameter.

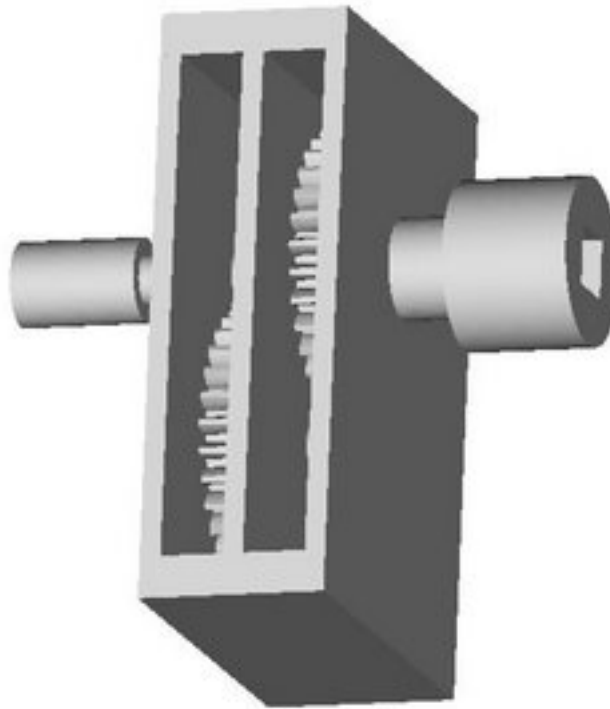

Tilting the model slightly to the left you can see the coupling collar receives a square drive shaft from the Siemens which measures 14 mm on the diagonal. That works out conveniently to a 9/16ths inch square rod. :-p

Tilting the gearbox slightly to the right you can see a bit more.

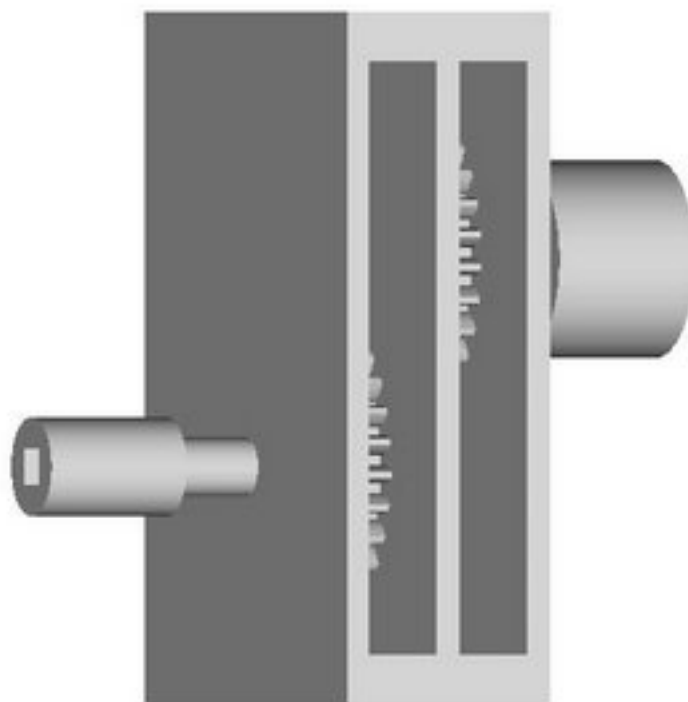

I've got to write a script to make a hexagonal profile since the collar connecting to the threaded drive rod needs to work with a long, hexagonal connecting nut. I used a square for now.

My initial feeling was to make the whole thing on the Stratasys. I did some tentative quantity surveys, however, and decided that Adrian wouldn't be glad of that given the volumes required and the cost of filament. Here's a look inside the first stage of the gearbox with the top and connecting collar removed.

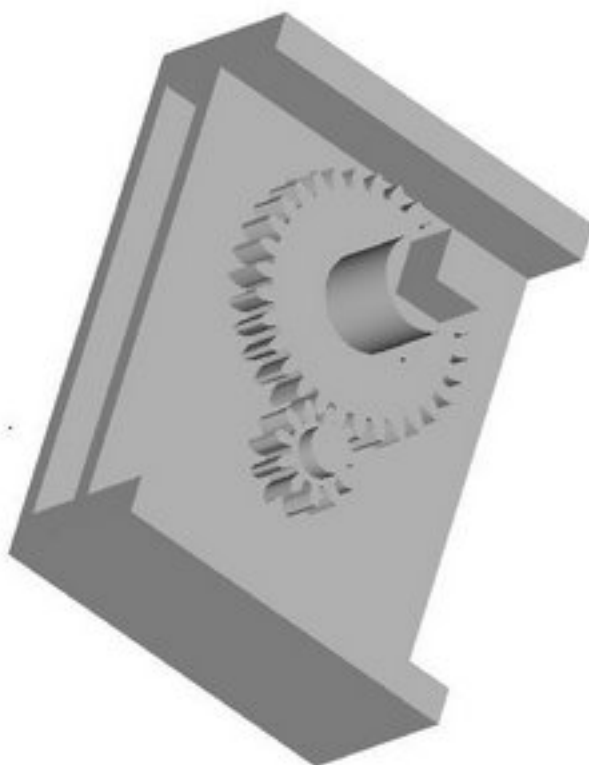

There is a lot of deliberate commonality in the parts for ease of manufacture. Here's a look at the gear train with the housing removed.

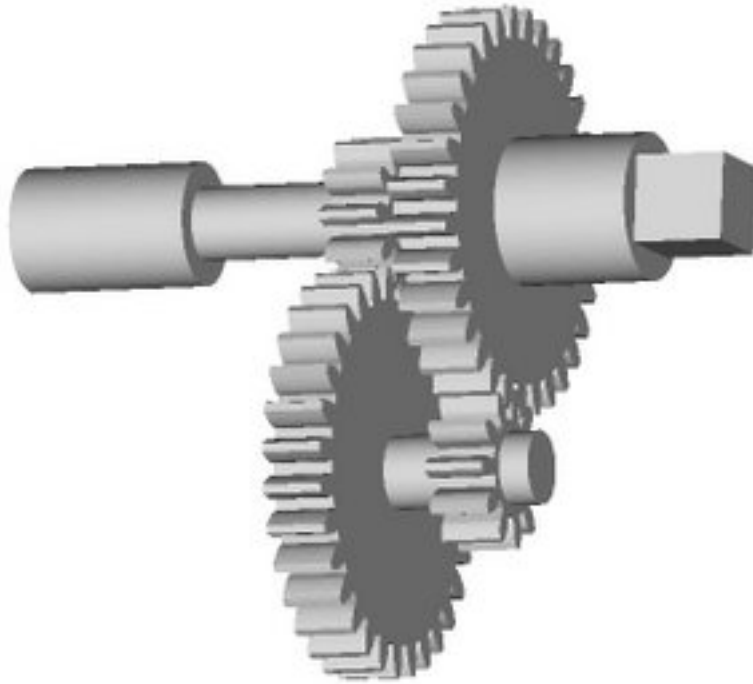

That two stage train gets you 7.8 mm/sec on the positioning stage. Add another stage to that using the same gears and you get 22 mm/sec.

After I got the first cut of the volumetrics of the design done it seemed quite reasonable that I could use standard sheet HDPE to make the housing if I was careful. I was reinspired by seeing one of Sebastien's references where a fellow built a whole CNC machine using plastic sheet.

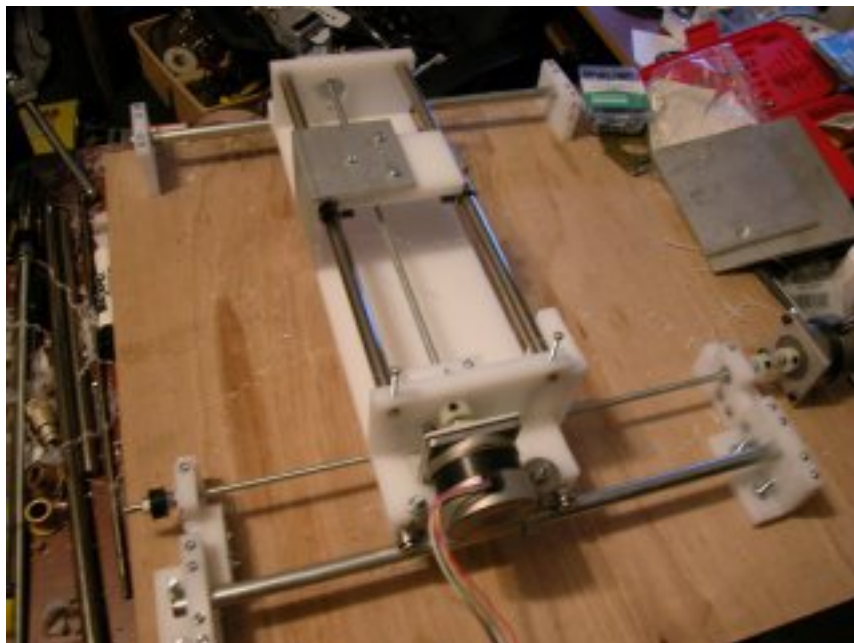

<http://biobug.org/cnc/klunk/>

Mind, it would be better, I think, if the whole thing was done out of the same material on the Stratasys given the wayward nature of my drill press. :-s Still, there are other ways to control costs and booking time on the Stratasys if that's a limiting factor. :-)

Looking at the idea in a whole different way I'm sorely tempted to just get a heavy duty DC motor that runs at about 2-3,000 rpm and just step it down by half.

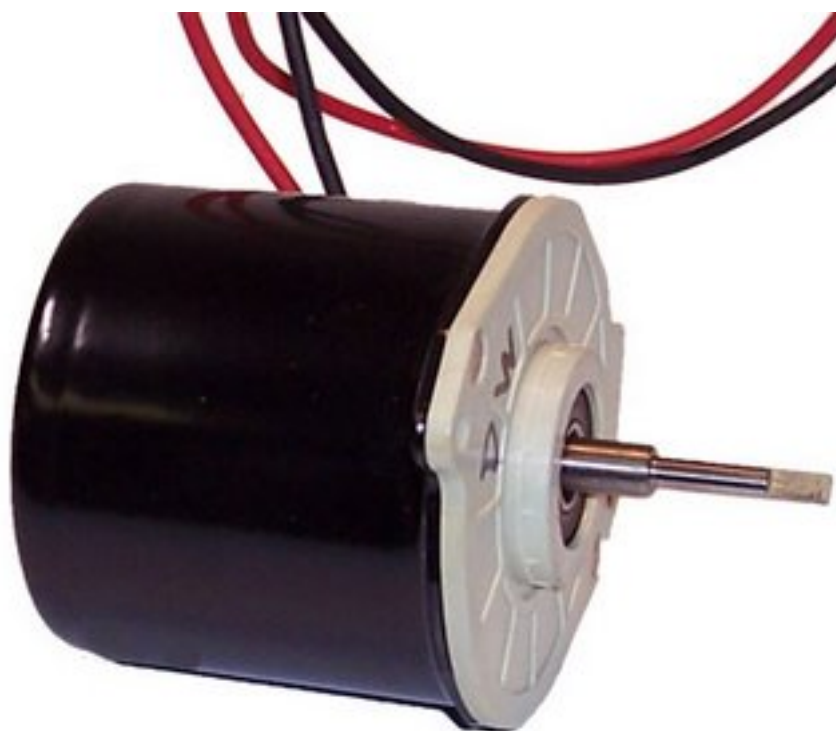

This one from MECI...

http://www.meci.com/product_info.php/products_id/4200577

...draws 2.25 amps and produces 2370 rpm. A simple 1.8:1 gear reduction would produce 20 mm/sec positioning speeds. It costs U\$5.95.

An even cheaper and more powerful one by all accounts from MECI...



... goes for a ridiculous US\$3.95 in one-off quantities.

I'm spoiled for choice here. I feel like the proverbial donkey between two piles of clover hay. :-s

Refill of the syringe

Tuesday, 16th May 2006 by james low

One final thing, removal and refill of the support material from the piping. A very simple method.

The plumbing pipe is fixed into a carriage, and held in place with two plastic rectangular traps (which go into the two holes seen in the side of the body). The whole mechanism is allowed to swing away from the body, enabling the plunger to be removed from the piping and the piping contents (i.e. support material in the form of Polyfiller) to be replaced or refilled quickly.

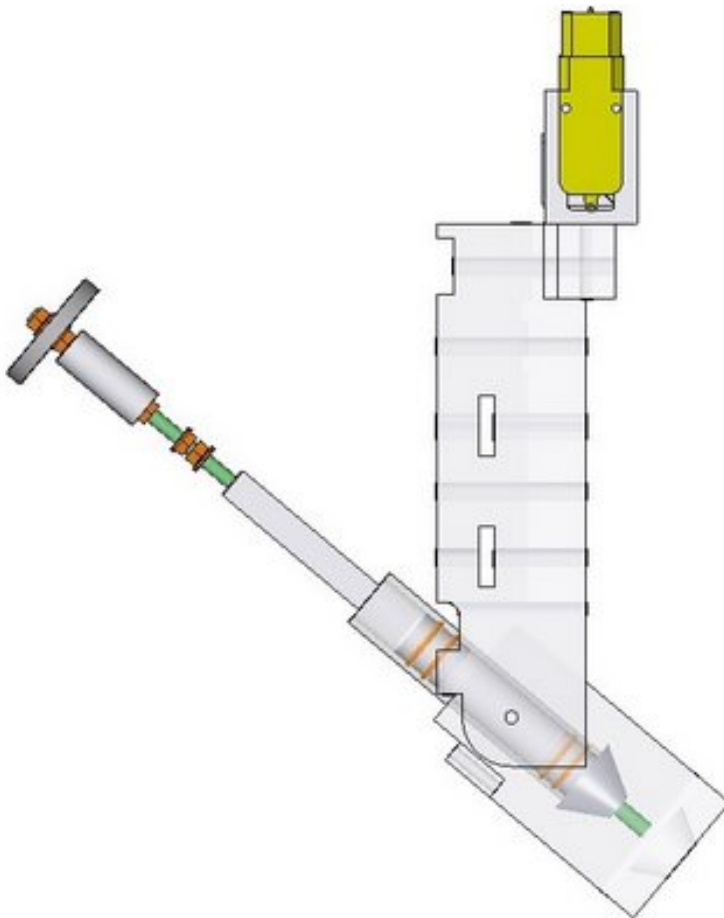

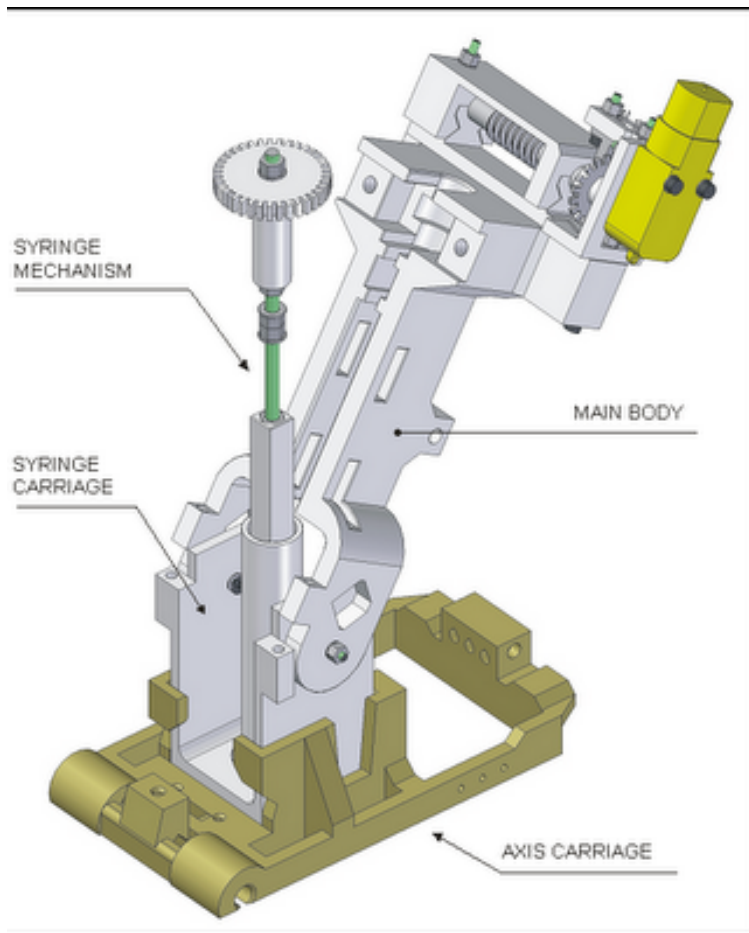
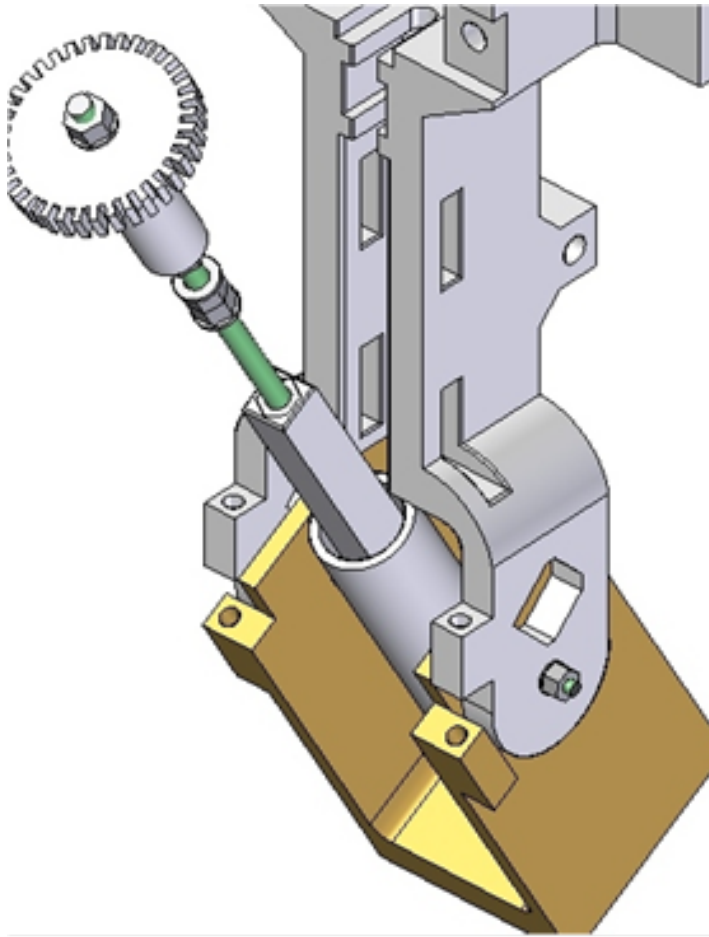

Then the mechanism is placed back into the carriage, which is locked up and the two traps slid back in place. All done in under a minute.

Support material extruder

Tuesday, 16th May 2006 by james low

Polyfiller is deposited from a fully automated, motorised syringe. A threaded bar is rotated using a worm and wheel, which in turn moves an embedded nut within the syringe plunger up and down the pipe (standard 22mm plumbing pipe), forcing the Polyfiller through the nozzle. The mechanism worked successfully, although the size of the unit could be reduced.

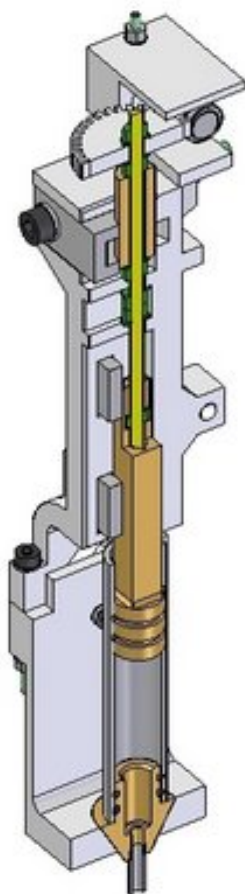

All the parts (except the nuts, bolts, threaded bar, nozzle and worm and wheel) were manufactured using the Stratasys Dimension RP machine.

The motorised syringe was integrated onto Ed's axis and it allowed straight line deposits to be made.

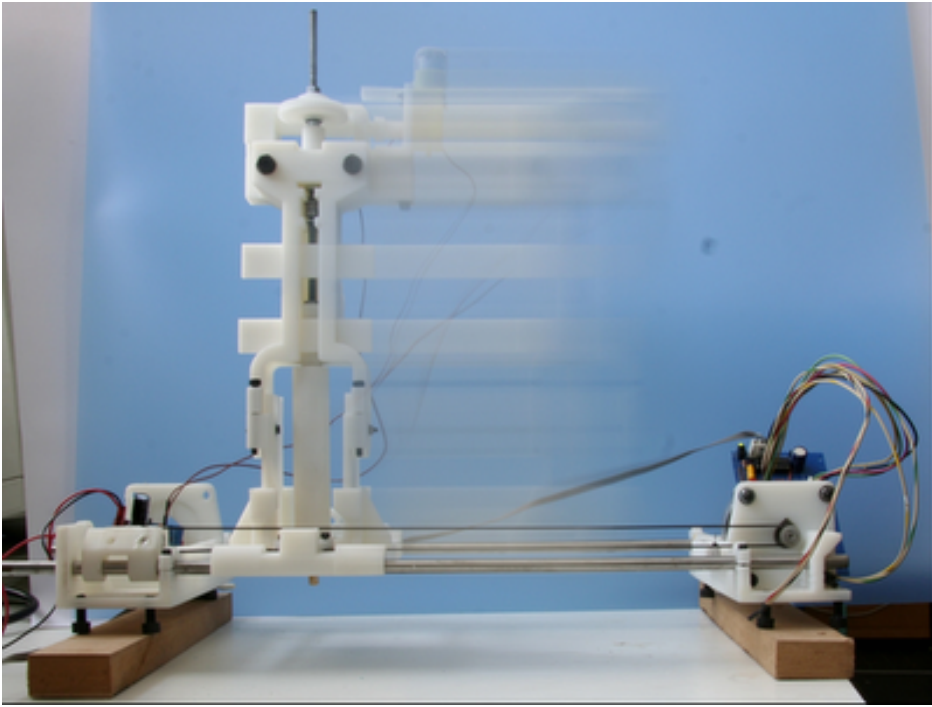

The current deposition rate is $4.49\text{mm}^3/\text{s}$ with the 50:1 gear ratio (12V power), however the deposition rate can be significantly increased (or decreased). The plumbing pipe is 100mm in length and stores 18ml of Polyfiller.

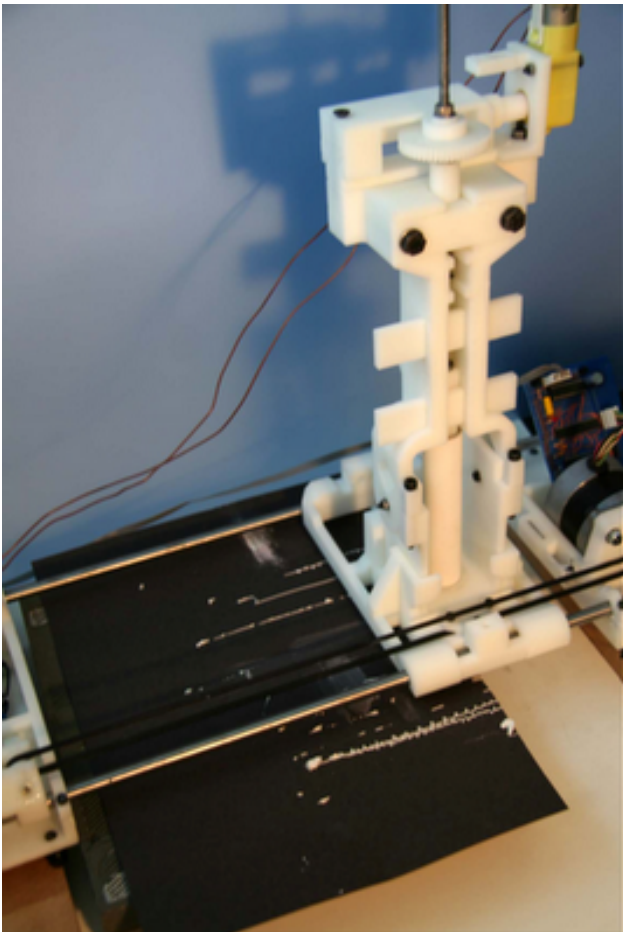



Desposit of Polyfiller using the motorised syringe.

Some work is needed on controlling the start and finish of deposits, but this is just a matter of starting the syringe before the axis and timing the deposition and movement correctly, something easily done with a few further tests.

It is also possible to utilise copper plumbing pipe should heating of the pipe contents be required.

Support material conclusions

Tuesday, 16th May 2006 by james low

Hi, so my (James Low's) final year project under the supervision of Adrian involved investigating and proposing an alternative, low-cost support structure material for the RepRap FDM process and the means of its automated deposition. So here are my findings.

Having had icing sugar proposed to me as an idea I quickly found that it was unable to be deposited at 0.5mm resolution and that it took a long time to set (over 1hour).

However, Polyfiller was the perfect substance. I was able to deposit Polycell Fine Surface Polyfiller from a 0.5mm nozzle, creating a perfectly consistent line, which set hard within 2 minutes.

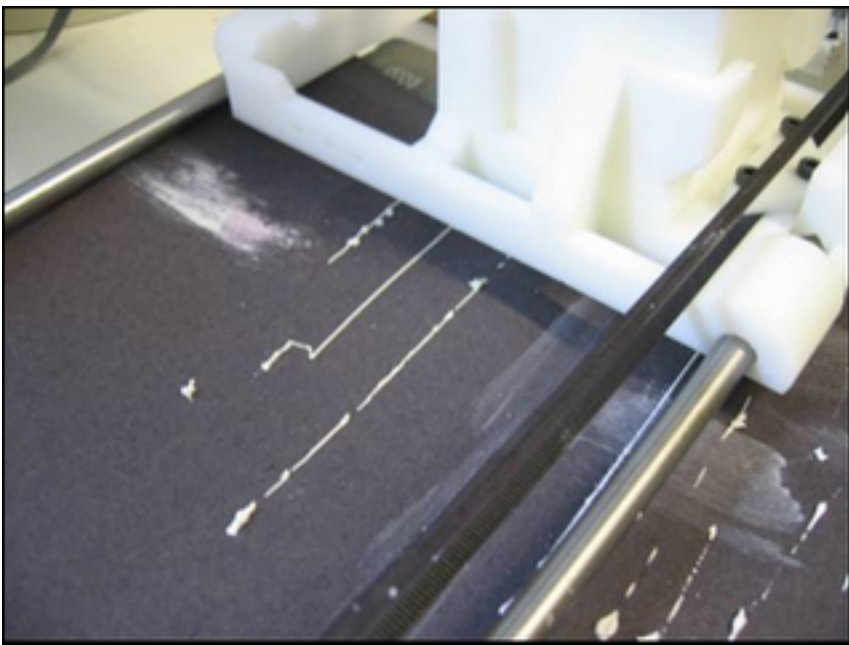

An initial problem was that Polyfiller, once set, would not fully remove from the surface of an ABS part(although it would remove from the syringe nozzle if placed in warm, soapy water within an hour or so of exposure). But Adrian's use of vegetable oil as a releasing agent on the ABS cude (Blogged in April 2005) resulted in using it (veg oil) to see if it would aid Polyfiller's removal from ABS parts, which it did perfectly.

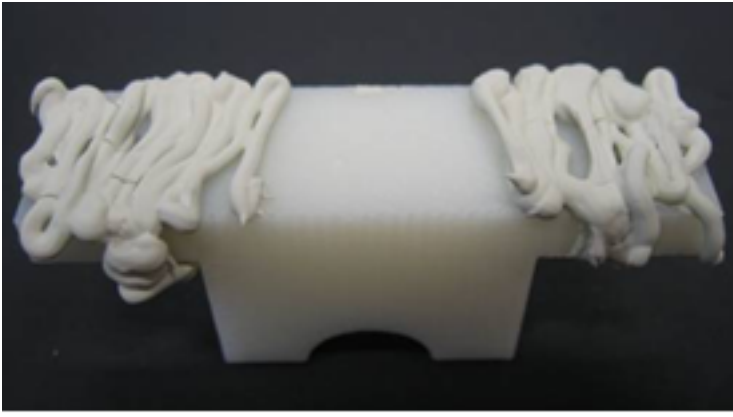

ABS part (previously coated in veg oil) covered in Polyfiller.

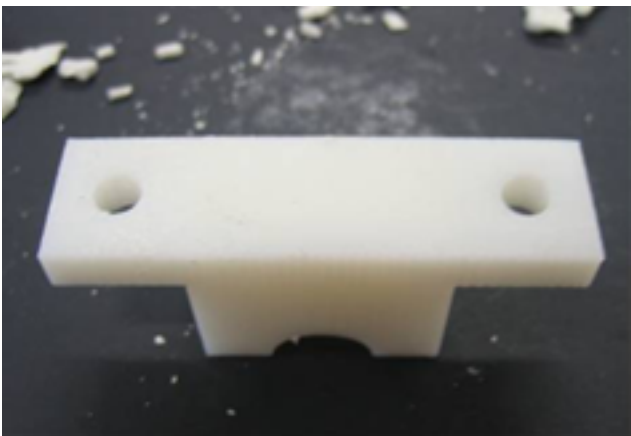

The same part after the Polyfiller had been removed.

The vegetable oil was deposited as a thin layer using a brush, and it was also possible to separate Polyfiller layers from themselves. It could be best to deposit the oil from a felt tip pen, replacing the ink with oil, which could then be simply deposited as a thin layer in the FDM process.



Ignore the cracked layer (it was cracked before the layers were separated).

The pictures and information regarding the deposition mechanism for the Polyfiller will be added soon (next few hours).

Godzilla vs the Siemens gearmotor...

Tuesday, 16th May 2006 by Forrest Higgs

I sometimes wonder where innovation would have got in the past forty years without duct tape. I did a quick lashup of the Siemens gearmotor (designed for automobile electric windows) to the horizontal z-axis on Godzilla and fed it 12v dc.

The Siemens gearmotor cranks 57,600 gm-cm of design torque vs the NEMA 17's 3,240. While I was having to constantly adjust the z-axis positioning stage with the NEMA stepper to get it to work at all, it was all that I could do to keep the thrust rod from unscrewing itself from the positioning stage with the Siemens motor running using about the same amount of current.

The "load" of the positioning stage, such as it is, made no difference to the design spec'ed 55 rpm for the motor at 12v. That motor speed gives me, 0.87 rps on the z-axis positioning stage, about what we're currently getting with the NEMA 17.

It seems kind of silly to gear the Siemens motor down to 55 rpm and then gear it back up to maybe 12-1400 rpm so that I can push that threaded drive rod at 15-20 cm/sec, but hey... these motors are cheap, efficient and tough. :-)

Magnetic Shaft Encoders

Wednesday, 17th May 2006 by Adrian Bowyer

My attempts to make a reliable optical shaft encoder blogged back in January 2006 didn't work well (see the [wiki page](#)).

Vik has been rabbiting on about the magnetic rotary encoder chips from [Austria Microsystems](#) for ages, and so I finally got round to trying them out.

Guess what? They are beaut!

I rapid prototyped a holder for a small piece of stripboard to go on the back of one of the geared motors that I used for the [Mark II Extruder](#), soldered one to the board, and put the lot together:

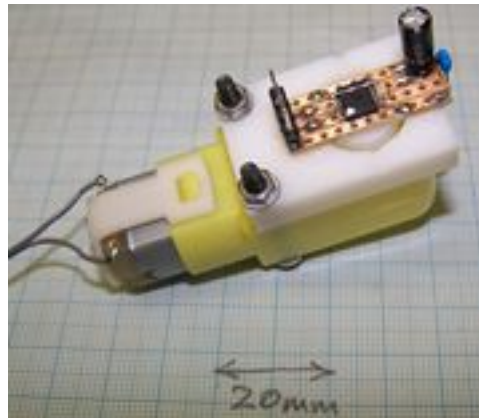

A small magnet is mounted on the motor's shaft, and Hall-effect probes in the chip encode the rotating magnetic field. Here's the scope trace:

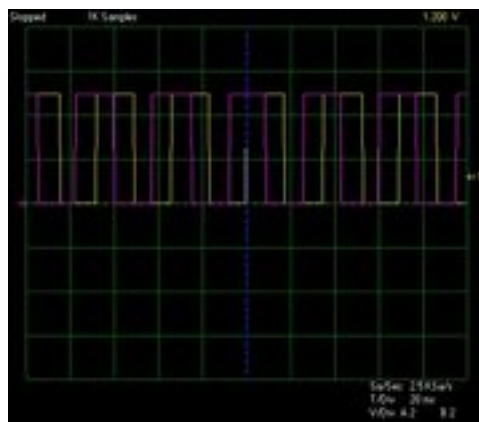

There are two outputs which give quadrature (i.e. the phase tells you if the thing is going clockwise or anticlockwise).

I used the chip that gives 256 steps per revolution (the AS5035), but they go up to 4096. The signal is clean reliable and easy to feed into a PIC. And the circuit is simplicity itself (though it needs to be soldered by ants, as the chip is SMT).

For more details, see the [Wiki here](#).

Finally a big thanks to [2001 Electronic Components Ltd](#), who gave me four of the chips and their associated magnets free. Buy stuff from them.

Steve Degroof asks a really good question...

Wednesday, 17th May 2006 by Forrest Higgs

Steve asked: If you can do a helical gear, does that mean you could also do a helical shaft?

Example: a 6" long, 1/2" diameter rod with 8 teeth spiraling up its length.

You asked a very good question. Turns out that we really can't even do a helical gear with the extrude feature as it stands. What we were generating only looked like helical gears. They weren't the real article since the helical twist wasn't helical, but only a straight line going in the same general direction.

I ran your spec just to see if it worked and this is what we got.

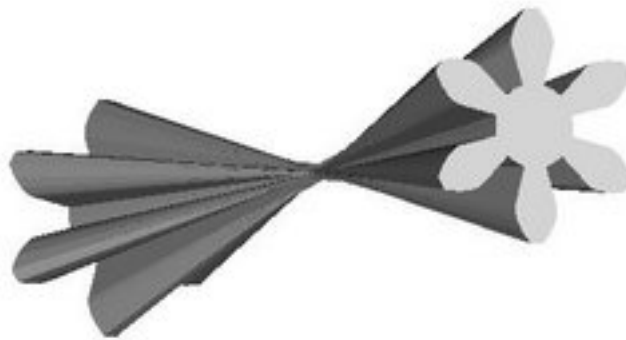

I gave the 6 toothed gear a 180 degree twist. As you can see the lines are straight, not helical.

Great catch, Steve. Anybody want to rewrite the twist option on the extrude code?

Flagulation

Thursday, 18th May 2006 by eD

Having finished the post mortem of ARNIE 1 I conclude:

"The design for ARNIE Mk 1 was flawed using a tension transmission for its z-axis movement: uneven tension behaviour caused jamming at the z-bed/vertical bearing surface which prevented the z-bed from working properly. This was exacerbated by an unstable structure, under-engineered and poorly build-orientated components, a critical modelling mistake which caused damage to critical corner supports and over-constraint of the z-bed's movement."

I'm off to get drunk, and possibly wipe my face with my degree certificate.

Helical gears back on again

Thursday, 18th May 2006 by Vik Olliver

It turns out that if you increase the number of segments in an ArtOfIllusion extrusion dialogue, the helical effect comes back into play when you're extruding Forrest's involute gear profiles. Here's a shot of one in action:



Image not found.

So, no changes needed by the Aol guys after all - and we should be able to RepRap liquorice sticks :)

Vik :v)

LOL! Oh dear, here goes... plaas programs the **PIC16F628**

Friday, 19th May 2006 by Forrest Higgs

Well, I got myself a nice little breadboard last night and a handfull of LED's, one of which I blew out before I figured out the serial resistance thingy. This weekend I'm going to see if I can establish serial comms with a 16F628 using the RepRap serial comms board. :-)

Simon & Vik's Bumper Fun Weekend Issue

Sunday, 21st May 2006 by Vik Olliver

Simon has been beavering away in his lair, producing a number of interesting bits of code. He's added a "homing" function, to get all the axes to find their minimum location using the sensors. He's also written a better algorithm for setting the heater temperature to reduce overshoot. It's a bit enthusiastic, but we're working on it.

I found a suspect inter-board cable and replaced it. That seemed to improve things a little. It appears that USB serial ports are still causing us trouble. I'll need another serial lead to attach the RepRap onto the PC with for the moment.

The electric screwdriver is now mounted and squirting happily. There is even an anti-backlash diode, which is needed now I'm using a TIP120 transistor to drive the extruder motor rather than a 754410. We discovered those don't have enough oomph. I also discovered they need an anti-backlash diode. Oh, and all the PC boards have sprouted smoothing capacitors.

The upshot: I can now print 2 layers repeatably. Why only two? Run out of 3mm filament again, haven't I? I've found plastic chopping boards are good for rolling it out between.

A fruitful weekend, and just as well as I'm off to Wellington next week for a couple of busy days. I can fit in a beer at the airport at 9pm Wednesday, Simon. My shout!

Vik :v)

Good news on the Java front

Monday, 22nd May 2006 by Vik Olliver



Image not found.

Smile! There has been some criticism of the decision to use Java, as it is not yet Open Source. Well, Sun have recently decided that they'll change the licencing for the Java Development Kit (JDK) so that it can be distributed with Linux, rather than having to be downloaded and installed separately. Here's [the story](#). In short, it'll soon be part of Ubuntu, Gentoo and Debian.

Vik :v)

The frankenscrewdriver

Tuesday, 23rd May 2006 by Vik Olliver

My brother-in-law did not realise when he gave me an electric screwdriver this Xmas that he was in fact providing a handy geared motor for driving the RepRap's extruder with. The Black & Decker electric screwdriver takes 4XAA batteries normally, but I'm running it off an extruder board using a TIP120 transistor instead of the 754410 H-Bridge. The whole thing is held very firmly by a couple of bolts and a wad of Polymorph/CAPA. The aerial (top, left of centre) has a little wire loop on it, which can be telescoped up and down to hold the 3mm Polymorph/CAPA rod out of the way during operation:



The clamp holds down the switch so I can turn the thing on and off by just regulating the current - and recover the screwdriver if brother-in-law feels miffed :)

Vik :v)

Echoing...

Thursday, 25th May 2006 by Forrest Higgs

I finally got my little UART programme to echo. :-D

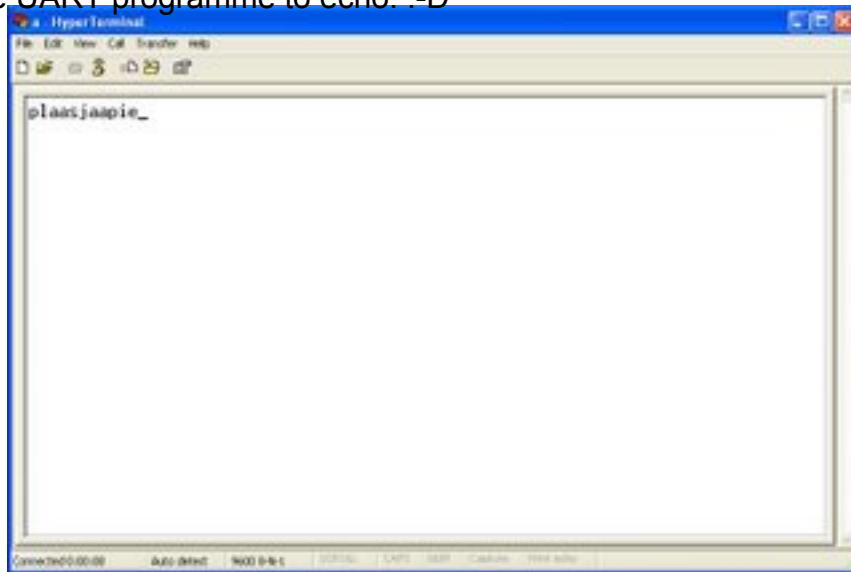

It's not wonderful, but it's a start and it's running at 9600 baud.

Shortly thereafter I massaged the VB.NET code for my serial comms programme.

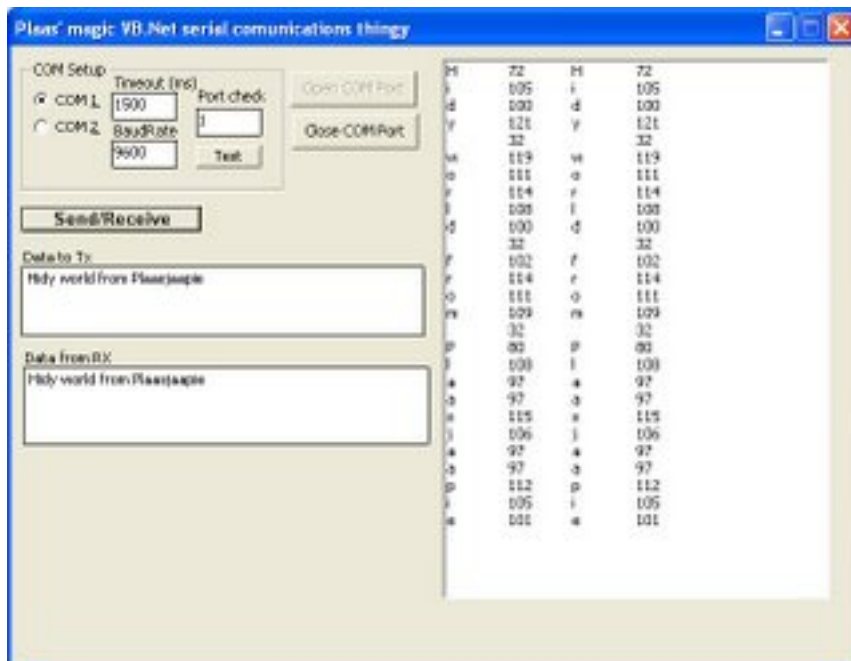

That enables me to interpret what goes out and what comes back and do things like throughput tests and the like and keep track of how reliable the comms link is. :-)

For my last act tonight I cranked the baud rate up to 19.2 to see if I had any problems. There weren't. :-)

Once I solid up the comms routines I will go on to implimenting the passthrough protocol for the token ring communications that Simon put together so that I can use my board on the same token ring with the rest of the boards. :-)

Digital servo

Friday, 26th May 2006 by Adrian Bowyer

I've finished and tested the servomotor with digital feedback using the magnetic rotary encoder. Here's a pic:

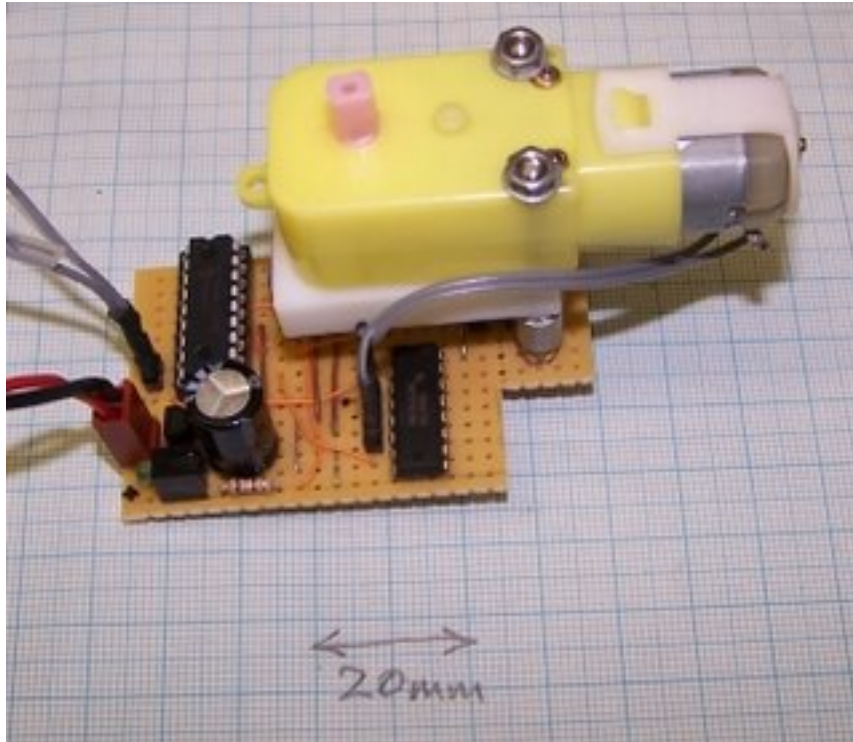

You can find how to build it on the RepRap wiki [here](#).

Its bad point is:

- It overshoots and oscillates about the final set position when set to move at high speeds. Though this settles quickly.

Its good points are:

- It's cheap,
- It gives high torque for low (100mA) current, and
- It's accurate (256 steps per revolution).

I don't think it's quite ready yet to take the position of a stepper motor, but it may well be possible to make it good enough just by improving the control algorithm in the PIC - that is, with no

hardware modifications.

It is certainly a good way of driving general devices with rotary feedback, and (I have yet to try this) it should allow rotation speeds to be precisely set and not to change with load.

Integrating the Frankenmotors into Godzilla...

Saturday, 27th May 2006 by Forrest Higgs

I mounted one of the new motors onto the Godzilla z-axis (horizontal). I had to widen the mounting hole, which I did with a wood rasp. Instead of bolting it down I used some of the ever-useful C-clamps to secure it to the bulkhead.

Speed tests

At 12v friction within the z-axis structure of Godzilla reduced a theoretical 40 mm/sec down to 30.5 mm/sec.

At 5.4 volts we timed the movement of the y-axis tower moving at 11.4 mm/sec.

Extrapolating from those two measurement points it would appear that it will require somewhere in the range of 1.5 to 1.9 volts input to achieve 4 mm/sec. I'm guessing the it will be a bit more than that, maybe 2-2.25 volts. I know that 12v friction accounts for 23% of the motor load. At 5.4v it accounts for 36%. One can reasonably assume that for 4 mm/sec the friction proportion of the motor load will be even higher.

Before anybody jumps to any false conclusions lamgoing to mimic voltages using pulse width modulation (PWM).

Vibration

Being able to run the z-axis at 30 mm/sec gave me some nice insights into the strengths and weaknesses of the design. At this velocity having the threaded power rod solidly attached to the bearings was essential. I used duct tape. Lock washers would be needed for a more permanent arrangement. Nuts tended to try to walk off of the threaded rod if they weren't solidly fixed and would do so very quickly. They also tended to take the bearings with them which caused all sorts of drama.

At 11 mm/sec the operation of the z-axis was much more manageable. Interestingly, the y-axis tower vibrated a bit but only to the touch, not visibly. I suspect that I can reduce that by applying a thin layer of felt to the support feet of the tower as I had originally planned.

Observations

At first blush it appears that Godzilla will beas designeda good test platform for extending the Mk II extruder performance up to 10 and perhaps as much as 15 mm/sec. My feeling is that the design will require a rebuild to achieve 20 mm/sec. Most of the problem of going much beyond about 15

mm/sec I think will happen in the x-axis bridge between the two y-axis towers. The Frankenmotors, because of their high torque, exhibit a considerable jolt on startup. For the z-axis motors this isn't an issue since they are solidly secured to the work table. Given the way I've designed the connection between the z-axis rails and the y-axis tower and the fact that the y-axis motors are not used while the extruder is in operation I suspect that a bit more felting will sort out the jolt of motor startup.

The x-axis, however, will be a problem. Startup jolt will tend to try to rotate the assembly in the yz plane. The y-axis tower's feet will tend to try to absorb this. At higher speeds, however, it could be a problem.

We discussed avoiding startup and stopping nonlinearities by not trying to extrude during these operations. There are going to be some very interesting control and firmware challenges in achieving these sort of translation speeds.

I am really looking forward to slapping a shaft encoder on one of these z-axis assemblies and building a control board for it. Getting two of the z-axis assemblies to work in concert should be even more exciting. It should be fun! :-D

Frankenmotors arrive...

Saturday, 27th May 2006 by Forrest Higgs

Well, the MECI 12v DC motors arrived but the magnetic shaft encoders didn't, which means that they won't be here till Tuesday. No big deal.

The first impression of them is that they are HUGE!

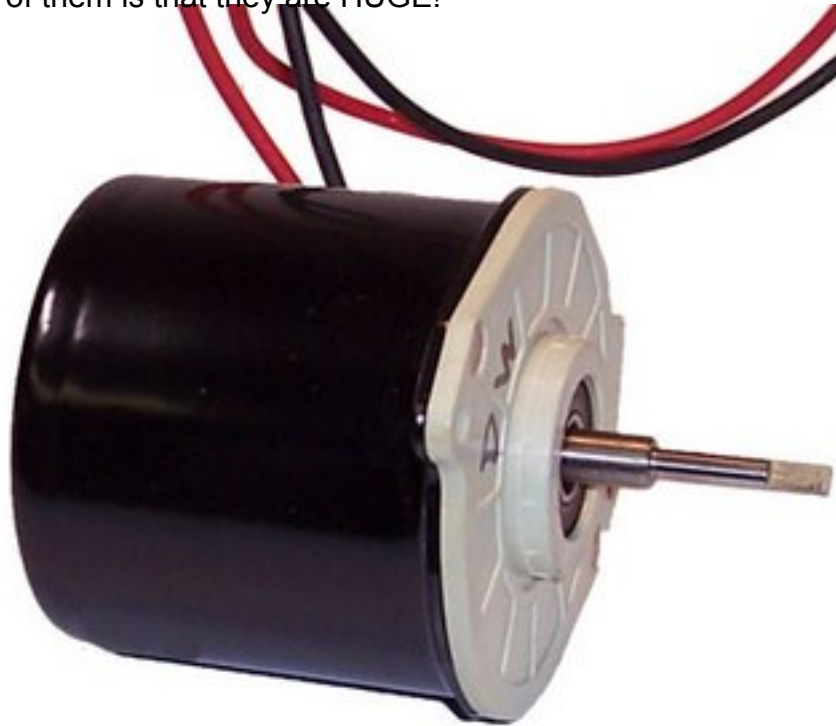

One of these would make 5-6 NEMA17's.

I fed 12v to one of them and it made a serious attempt to jump off of the work table. At 5v and roughly 1000 rpm (16 mm/sec) it is still putting out loads of torque.

I connected a 1.57v AA battery to the motor and it turns at a rate that looks to be about 300 rpm (5 mm/sec).

From there I went on to check amperage at the 3 voltage levels. Here is approximately what I got...

- 12v - 2.3 amps
- 5.5v - 2.1 amps (after motor warmed up)
- 1.57v - 1.7 amps (AA Battery)

All three amperage measurements were for the motor in an unloaded state. I doubt that the AA

battery was capable of delivering much more amperage than it did. The important bit, however, was that the motor turned smoothly at that voltage and delivered a considerable torque.

Given the fact that this motor is a brushed DC motor measuring the resistance of the armature was a bit tricky. It appears to be about 0.7 ohms, however.

Tomorrow I plan to bolt one of these to the z-axis and cobble some sort of coupling to the threaded drive rod together. :-)

0.5mm Mk 2 extruder trials/tribulations

Sunday, 28th May 2006 by Vik Olliver

Getting the 0.8mm nozzle on the current 3D axis/extruder setup showed that we're basically on the right track, but the trail deposited by the 0.8mm nozzle was far too big. Also, the rather flat profile of the 0.8mm nozzle tended to drag plastic trails around the surface of the workpiece.

So I made a 0.5mm nozzle with a more conical profile. This extrudes a 0.8mm filament, which with care and attention might make a trail narrower than 1mm. Maybe even not too far away from the Stratasys' 0.6mm minimum reliable extrusion width. Interchangeable nozzles continue to be a great idea.

But lo, the pressure generated inside the extrusion mechanism is higher with the smaller nozzle, even when the motor speed is decreased to allow for the reduced throughput. This means that the feed mechanism is now much less tolerant of dodgy feedstock, and I have had a great number of jams with my last batch of somewhat lumpy feedstock.

After a few attempts and unjammings, the entire heater barrel assembly was extruded from the PTFE rod. It just popped out. Now, I'll freely admit that the original tapping of the PTFE wasn't the world's best, but all the same I wasn't happy. Fortunately I had a section of 16mm diameter PTFE and a clamp modified to hold same. As this wouldn't fit in the Afghan lathe, I drilled it manually - hence the 3mm off-centre hole at the far end.

Instead of tapping 15mm of M6 thread to hold the heater barrel, I tapped 20mm. Not only that, but I used a pilot hole of 4.5mm rather than the normal 5mm hole used for M6 tapping. I took the heater barrel off the old concrete extruder because it had a longer bit of thread sticking out the back of it and re-assembled.

After a few more jams, the new thermostat algorithm started playing up, and the extruder heater would inexplicably just turn off. I've asked Simon if we can re-implement the old "bang-bang" algorithm, which seemed to be more reliable and resulted in far fewer pauses for the element to re-attain working temperature.

I never managed to complete a single layer of the test articles using the new nozzle, but I'll try again later in the week once the bang-bang thermostat is re-instated. The output that was produced looked good as far as it went, and once I get the layer's thickness sorted out it should produce some tidy results. Might make some neater feedstock too.

Vik :v)

Speculations on RepRap 2.0

Sunday, 28th May 2006 by Forrest Higgs

Discovering plateaus of very smooth performance (reported in our sourceforge forum) of the threaded rod drive axes last night got me to thinking about what a next generation RepRap might look like.

I hadn't expected to get a Godzilla axis running at 38 mm/sec under any circumstances, never mind smoothly enough to think about extruding at that speed. Actually, using our dodge of extruding on a diagonal we would get $38 \times 2^{.5}$ or about 54 mm/sec. I spent a little time this morning wondering what a RepRap operating at those extrusion speeds would look like.

First off, a long time ago I figured that the Mk II would extrude 2.83 cubic centimeters of polymer/hr operating at 4 mm/sec. I most likely underestimated the extrusion rate in that I assumed, those being very early days, that the polymer thread would not expand after having left the 0.5 mm extruder orifice. Subsequent experience has shown that the thread expands as much as a third. That would mean that in reality the Mk II was extruding something like 3.8 cm³/hr.

What would a RepRap capable of putting polymer down at a rate of 54 mm/sec perform like?

At a 100% duty cycle (unrealistic), it would put down 50 grammes of polymer/hour...

...or 1.2 kg/day

...36.5 kg/month

...438 kg/year

In home use such a RepRap would likely see an 8 hour duty cycle daily, which would mean 12 kg/month or 146 kg/year.

That is still a lot of polymer seeing that it costs about US\$12/kg.

When I first built Godzilla I did a volumetric quantity survey of the structure. A one-for-one poplar to polymer replacement meant that it would take about 7 kg of polymer to replace its structure.

Godzilla could replicate itself in 17 days or make 21 copies of itself in a year.

That would be pretty much unstoppable as a diffusing technology.

Just for fun I tried to scale up the Mk II to something that would be able to put out polymer at this

rate to see what the design envelope looked like.

Using 3 mm filament the feed mechanism would have to run at a rate of .15 mm/sec or 9 mm/minute. Given that the M3 studding rod we are using as a drive to feed filament into the extruder barrel has a 0.5 pitch we are looking at a rotational rate of something like 18 rpm out of our little G4 gearmotor. That doesn't look to me like something that it couldn't do as it since it is rated at 70 rpm.

Where the Mk II would have to be upgraded, however, is in the nichrome wiring for the extruder barrel. Right now you're using about 300 mm of .2 mm diameter nichrome to provide about six watts to the barrel. You'd need 13.5 times that, or about 80 watts, to run at 54 mm/sec. That's 4 metres of nichrome. You might want to think about one of those ISM sleeve heaters, except that you'd have to redesign the extruder barrel since the minimum diameter on one of those is about 20 mm.

Frankenmotor meets Godzilla...

Monday, 29th May 2006 by Forrest Higgs

My son came home for the holiday so I had his digital camera to record a bit of what I've been talking about. I'd have had the old Sony digital camera that I usually use except that my sister and former partner in my consultancy went off horse shopping to Wyoming and took it with her. :-)

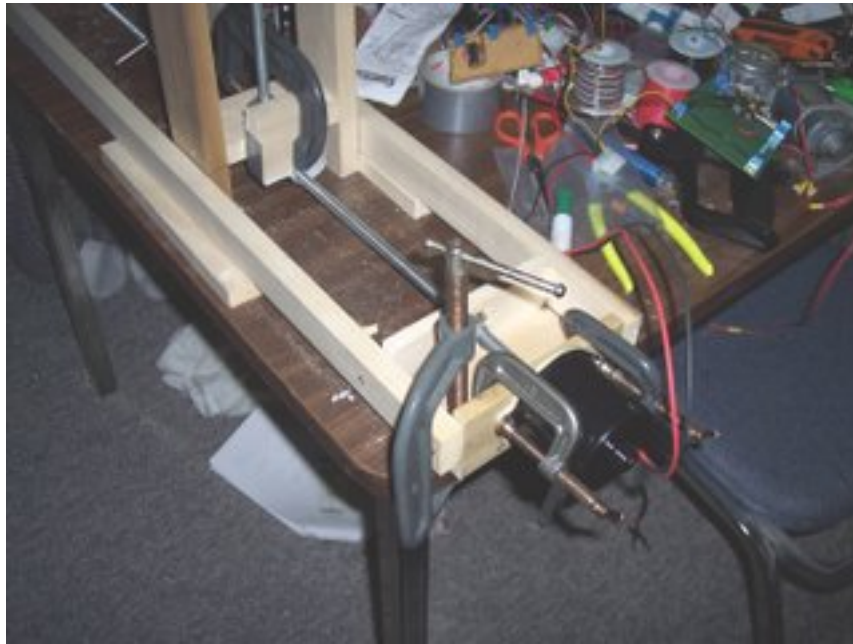

As you can see the Frankenmotor sets into the Z-axis mounting bulkhead with no problems whatsoever.

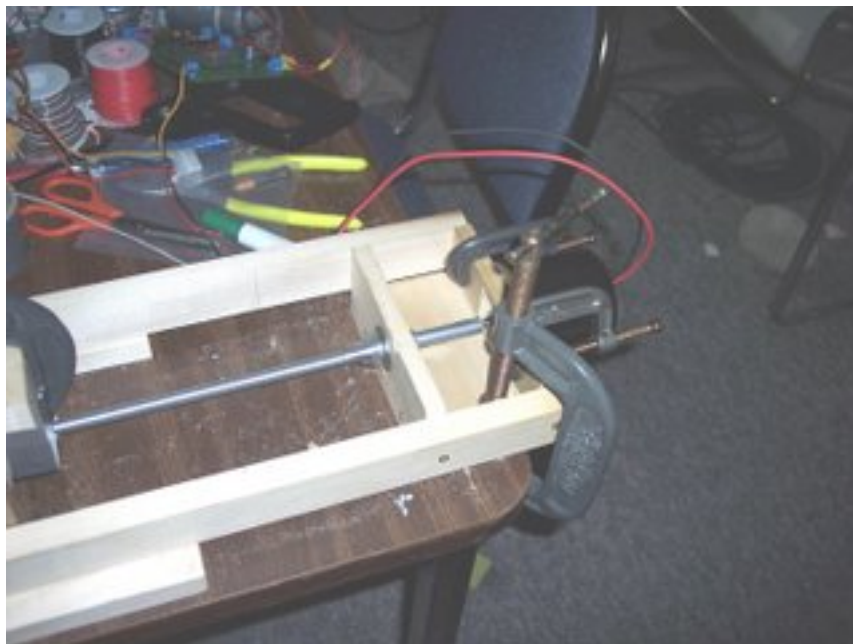

In the second pic you can see my duct tape coupling connecting the motor to the threaded drive rod. Interestingly, I've been running the y-axis tower back and forth for two days now and the

coupling is just as good as when I wrapped the joint.

Here is a link to a Quicktime movie of the z-axis doing its 38 mm/sec act.

[http://www.sanma12.com/RepRap/z-axis movie.mov](http://www.sanma12.com/RepRap/z-axis%20movie.mov)

Please take note that the axis in operation is not a hundredth as loud as it sounds like on the movie. My son's camera microphone is adjusted to pick up conversation and rather quiet conversation from a considerable distance at that. The axis in operation comes out sounding like a jackhammer operated by a deranged chimpanzee.

The Plan...

Wednesday, 31st May 2006 by Forrest Higgs

I bought the parts to do the cable motion transfer system for Godzilla. Here are some quick sketches of how it will work.

Y-AXIS (vertical)

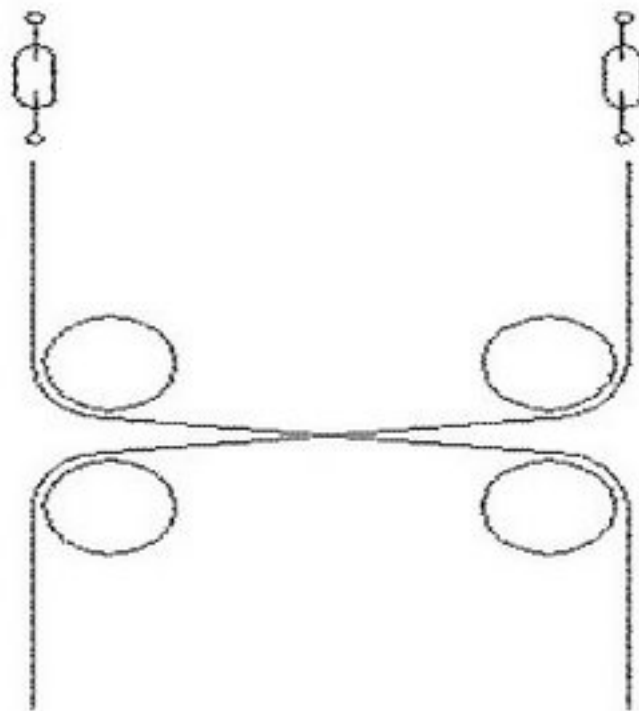

The y-axis (vertical) cabling is a very standard parallel bar pulley and cable arrangement that you used to see on drafting tables.

The parallel bar in this case is the x-axis (horizontal). This arrangement will be done on both sides of the x-axis beam, front and back.

The vertical cable paths will lie on the same line as the y-axis threaded drive shaft that will move the x-axis beam up and down.

Z-AXIS (horizontal)

The z-axis layout is slightly more complicated, but not greatly.

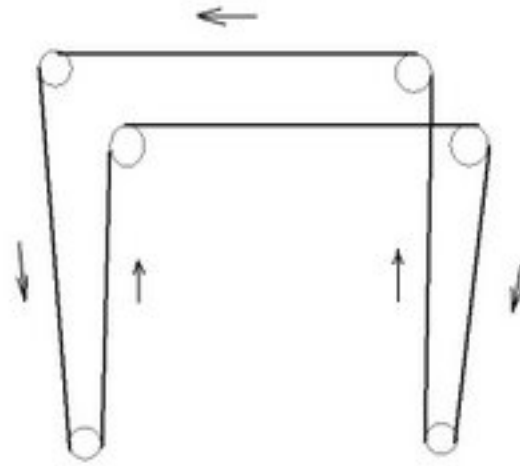

Cable moves from the left z-axis assembly to the right across the top (back) of Godzilla. I've not shown a turnbuckle and spring in this one that I'll be including. The two inner cable tracks with the upward pointing arrows will be attached to the centre-line of the y-axis towers.

Motive power is supplied by the Frankenmotors driving threaded rods on the left hand side of both sketches. It should work. I've got the parts and should know in a few hours, though I may be a bit short of cable and have to do the y-axis towers in the morning, :-)

Plaas catches the cable and pulley disease...

Wednesday, 31st May 2006 by Forrest Higgs

I'm blaming it on Ed. That's my story and I'm sticking to it.

The z-axis is working fine and I'm working on getting the x-axis cranking. I was at the hardware store and saw all the nice little nylon pulleys for curtains....

...then I got to thinking that I'd only bought just enough of the Frankenmotors for Godzilla and I really needed some spares. Being of Scots-Irish ancestry I got to thinking that a cheap way to get spare motors is to not need so many in the design...

...and since the Frankenmotors have enough torque to run 5-6 axes each, never mind one. That, of course, hooked up nicely with the idea that if you only have one motor per axis you don't have to solve the problem of making two motors run in tandem...

...and away I went. Half an hour with my whiteboard and markers and I have a plan.

I LOVE this project! :-D

Quick work with the 0.8mm nozzle

Sunday, 4th June 2006 by Vik Olliver

I'm getting quite handy at making detachable nozzles, and this 0.8mm one is I think the least imperfect yet.

The almost 45 degree taper ensures that it doesn't stick much to the substrate, and thus smear everything. Inside, I reamed out right up to the point with one of those reamer bits for a Dremmel tool that look like a little lemon squeezer. The point poked through the hole. Consequently, the flow rate is very high, and it hasn't jammed up the drive mechanism yet. I'm actually running it at less power than the 0.5mm nozzle:



Image not found.

I've left the crosshatch pattern slightly wide, so I can measure the widths of the deposition. For the record, the lines are 1.1mm wide, and each of the two layers are roughly 0.55mm thick - the huge blobs are where the machine pauses to reheat the nozzle and all the plastic runs out. The crosshatch generator believes the lines to be 1.3mm wide. If I slow the motor down much more the lines will get thinner but I think it'll stall. We'll see.

I used about 0.6 metres of CAPA/Polymorph feedstock today! Best make more.

Vik :v)

Making the 0.5mm nozzle work

Sunday, 4th June 2006 by Vik Olliver

Prior to each test run I have to go through this ritual of finding out which connection is faulty due to intrusion by felines. After flattening the prongs on a few connectors to make them harder to pull out, I got the whole thing going again this morning, with a 3.5mm hole in the middle of the new PTFE block to cope with badly-mangled feedstock (the threaded extrusion mechanism was distorting it somewhat). Still, I've managed to lay down a closely-filled test article with the 0.5mm nozzle, using the aforementioned strengthened 16mm PTFE insulation block to hold the heater. This one is not going to pop out:



Image not found.

But a number of undesirable changes were needed to make this work. The extrusion speed had to be dropped to around 25% of maximum, with the stage speed needing to be dropped slightly as well (215 out of 255). Attempts to extrude at higher speeds resulted in the 3mm Polymorph/CAPA feedstock getting wrapped around the threaded rod in the Mk2 extruder as shown below. I have modified the design of the poly-holder to prevent this from happening, and Adrian is running one off on the Stratasys.



Image not found.

The extruder mechanism also becomes exceptionally sensitive to feedstock quality under high load. Motor speed becomes uneven at variations of 0.2mm (note the uneven edges of the hexagon above), and joins have to be perfect. I achieve good joins by forcing the melted ends of feedstock into opposite sides of a 3mm hole in a block of PTFE.

A better build of the extruder's threaded rod might help, as will a suggested future addition of a

speed controller for the extruder. What would help is if someone could extrude some 3mm feedstock for us. Anyone got a spare plastic injection machine that'll do it ? :)

Simon has changed the code to allow different deposition speeds when depositing on an angle, and also to move down one layer **before** repositioning the head for the next layer. This should reduce some of the smearing. We also need to move the head to one side while re-heating the extruder, and to deposit a test line before each extrusion to ensure the nozzle is fully-charged.

Any leaks around the removable nozzle are soon exposed at these pressures. I have not yet needed to use PTFE tape to take up the slack, though a silicone 'O' ring or washer cut from tube might be useful. I might drop back to using a 0.8mm nozzle for the next round of tests. 'Course, I'll have to build one first...

Vik :v)

Basically PIC...

Monday, 5th June 2006 by Forrest Higgs

The Oshon Software PIC Simulator IDE system appears to be an effective, affordable way to work with the PIC16F628A.

I'd previously built up several test boards for the PIC and was trying to crack the serial comms/UART problem

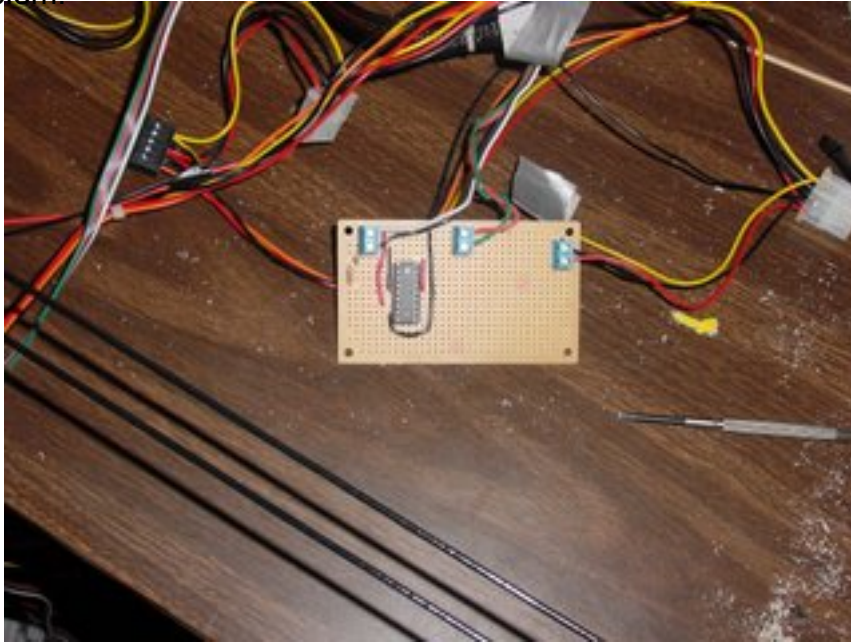

The BoostBasic compiler I tried sorta/kinda worked but Assembler worked a lot better but still had some troubling sorts of behaviours.

It took me 5 minutes to retarget some UART code written in Oshon PIC Basic from the PIC16F877 to the PIC 16F628A, compile it, burn it onto the PIC and get it running first with Hyperterminal and then with the little VB.NET serial comms programme that I'd adapted to talk through the RepRap comms board to my PIC test board.

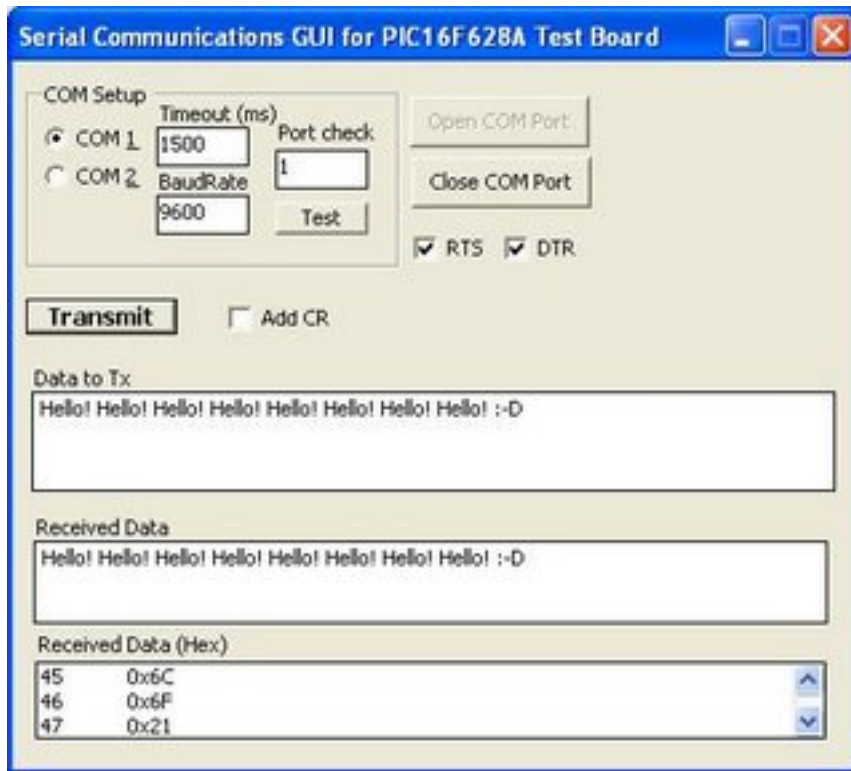

An hour later I rewrote the UART sample code to do a proper job of echoing. That took another big 5 minutes to go from writing to testing the reprogrammed PIC.

My next project will be to build up a little PIC test board with a SN754410 and program it to do speed control with a PWM routine that can be controlled through my serial comms programme. Oshon has a very nice little software emulator for PIC chips that takes your hex file, lets you execute it in software and keep track of what all the ports and registers are doing. I ran it with my UART programme and was able to keep track of the serial IO that I put into the chip and watched it come back out, all before I tried to burn it onto a chip.

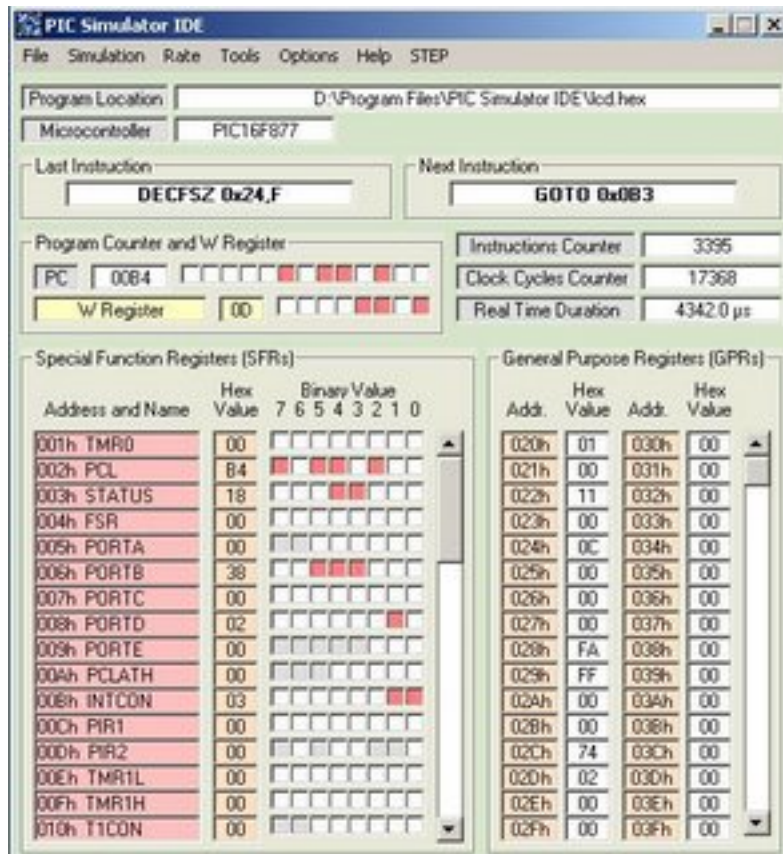

I'm hoping to have time in the next week to get used to running that well enough to make sure that what I think is happening with PWM is really happening. :-)

After that it's integrating the AustriaMicrosystems shaft encoder chip and after that integrating the Hamamatsu optical detector chips for limits control.

Then comes the hard part. I've either got to find a much higher amperage equivalent of the SN754410 or I've got to build one up from components. I have several good schematics for that sort of thing, but the circuits I have will have to be added to for directional control. Hopefully, Freescale has some driver chips that do all that. Their catalog descriptions look hopeful. :-)

G4 Motor Control Card

Wednesday, 7th June 2006 by Forrest Higgs

The Oshon Basic compiler made establishing serial comms with the PIC16F628A UART pretty much child's play. Adrian's schematic for controlling a G4/rotary encoder ensemble was pretty clear, so I decided that my next baby step would be to see if I could just control a G4 from my PC via serial comms via our standard PIC. I trimmed down Adrian's schematic to the bare essentials and built up a test board

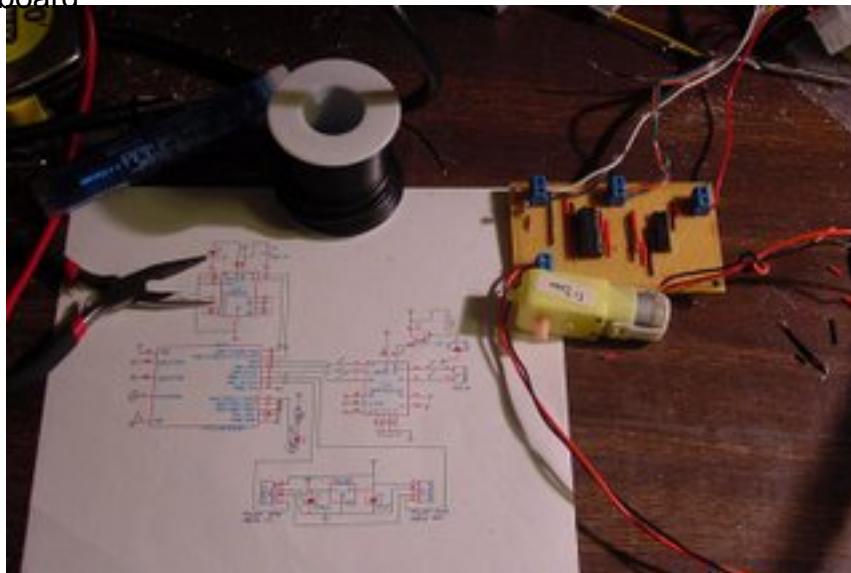

I was then able to leverage the UART programme that I knew already worked to test the board and got it going on the third try after breaking a strip that I'd missed with my Dremel tool and soldering a dry joint that I'd also missed.

It's one thing to just echo characters back to your PC and quite another to send the PIC some information and have it recognise what it is and to know when it has it all and then to tell you that it has it.

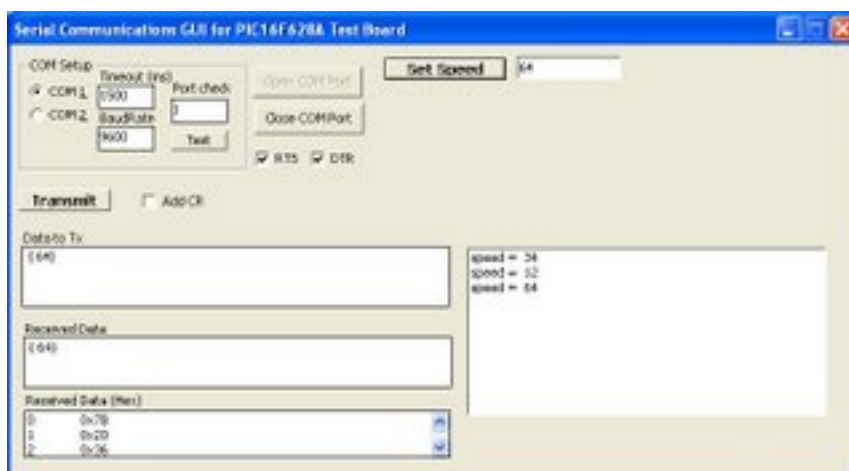

That took a bit of hacking at the VB.NET serial comms programme and well as the PIC

programme, but with the Oshon PIC Simulator it went fairly smoothly. Now that I have the PIC getting motor speed information from the PC the next step is to port Adrian's PWM routine into the PIC programme and see if I can crank the motor. :-)

PWMing along...

Thursday, 8th June 2006 by Forrest Higgs

Got the little yellow G4 gear motor going on the test board. I wore out two PIC16F628A chips learning how which is cheap at the price. :-)

Here's the little test programme in BASIC that does the job...

```
TRISB = %11000111
```

```
PORTB.5 = 1
```

```
PWMon 1, 9
```

```
PWMduty 1, 200
```

That's it. The TRISB and PORTB settings I got out of Adrian's servo.c code. Works like a champ.

Things started moving really fast after I figured out how to connect the virtual oscilloscope to the virtual PIC16F628A chip. I've also got a virtual signal generator which should let the retarded Plaas integrate the rotary encoder chip and limits switches when I get my nerve up to try that. :-s

Here's a pic of the IDE in action.



YES!!!!!!

And the second string does exhibition during timeout...

Saturday, 10th June 2006 by Forrest Higgs

I was down to two working PIC chips and didn't want to waste the weekend, so I went back to working on the cabling for Godzilla.

The biggest job was getting a Frankenmotor installed in the x-axis ensemble. I had to excavate a considerable cavity in both side supports with a chisel to get it to fit. The real pig of a job, however, was getting the motor shaft aligned with the threaded drive shaft.



I got it done, but it took most of the morning, very fiddly stuff.

Adrian wanted to see the two y-axis towers with the x-axis ensemble on board. Here it is.

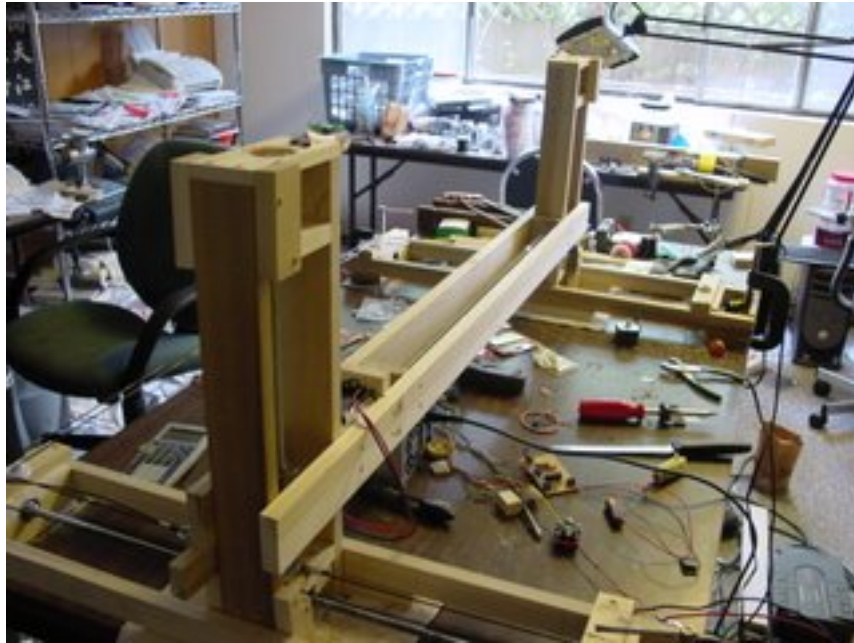

For good measure here are two short video clips of it running as an ensemble.

[Drive side video clip](#)

[Far side video clip](#)

I was playing music this morning during the tests which sounded considerably better than the deranged chimpanzee on the jack hammer noise of the motors by themselves. That loud snapping in the first clip is me switching the toggle switch. It gives you some idea of how sensitive the camera microphone is.

If you like the music it was done by a jam session consisting of part of a musical group called Spjlimenninir i Hoydlum (lit. Players/Musicians in Hoydlum) in the Faroe Islands plus Angelika Nielsen, Jakup Ltzen and another very young woman violinist whose name I do not know.

I was listening to a series of their performances at some sort of folk festival at Gta. You can find the clips at a favourite little folk music website of mine which originates out of Scandinavia.

If you go there and click on the Faroe Islands buttons you can listen to Spjlimenninir. Angelika Nielsen, the big blonde violinist on the clips, also has a solo piece on the same links page. She's a dead ringer for my ex-wife (though she's maybe 15-25 years younger than my ex is now) whose family hailed from that same neck of the woods (Shetlands and Orkneys) maybe 180 years ago. It must have been a tiny little gene pool. Mind, I suspect I would still have my ex-wife if she had been that musically talented. I love that kind of music. :-D

You know, though, I wonder at times whether listening to that sort of music keeps the shadows at bay or simply beckons them closer like a warm campfire on a cold evening. :-)

Video of Da Witch in action

Saturday, 10th June 2006 by Vik Olliver

There have been a few requests for some video, so here's a 2.7MB straight MPEG, about 24s showing the deposition process in action on the Da Witch prototype. This is a still taken from the video and the object being deposited:



Image not found.



Image not found.

The hexagon is being deposited with a 0.8mm nozzle running at 140C driven by the latest GUI. The mess on the left of the new glass deposition surface is where the nozzle moves to dribble when it reheats. The glass is held snugly on the stage by cunningly-shaped self-adhesive foam strips.

Here's a shot in close-up of the plastic still hot and transparent, exuding from the nozzle in the second layer of a cross-hatch pattern:

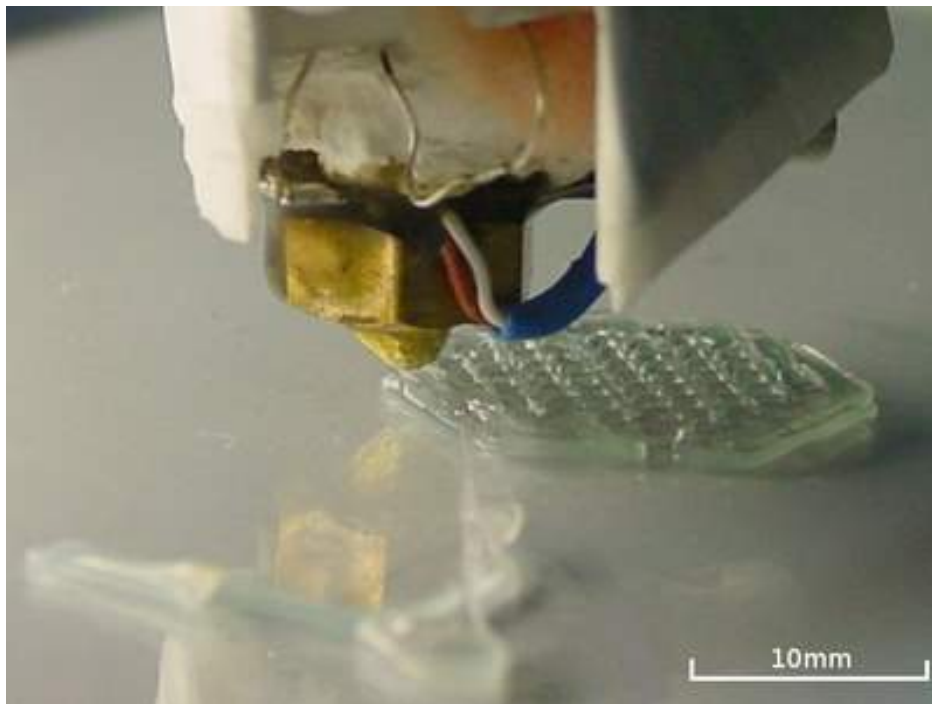

So far the most complete layers we've deposited is 4, but this has been done a few times now and is no longer an unusual or particularly tricky event. Now it is repeatable, experimentation to find the best nozzle can begin changing one factor at a time. That's science :)

Vik :v)

Frankenmotors running all three axes on Godzilla...

Sunday, 11th June 2006 by Forrest Higgs

I got the little x-axis platform that will carry the Mk II extruder built this morning.

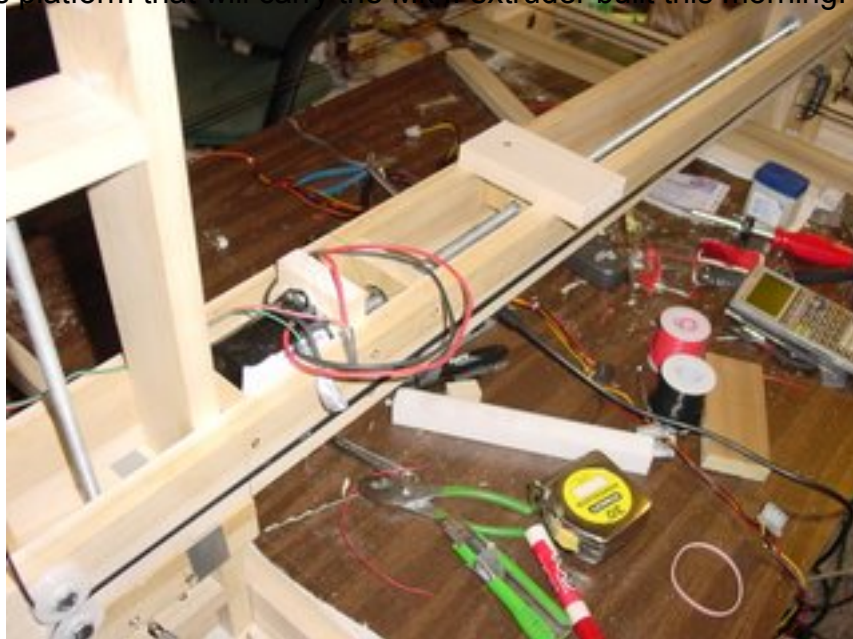

The x-axis is translating at about 28 mm/sec right now. I expect that that velocity will pick up substantially as the drive collar coupling nut and the threaded drive rod wear in a bit.

With the z-axis translating at 32 mm/sec and the x-axis moving at 28 Godzilla has a maximum extrusion speed of about 42-43 mm/sec right now. That's using 12v.

I ran the test over again using 5.45v and got the z-axis moving reliably at 10 mm/sec and the x-axis moving at 7 mm/sec. Hah! I may be able to start working at improving the MK II even before I get the axes' speed controller boards finished. :-D

Here are a couple of videos of the z and x axis running at the same time.

Short clip

Longer, more uncoordinated clip

Slicing and Dicing

Sunday, 11th June 2006 by Adrian Bowyer

The code to take horizontal slices through STL files is coming along.



The picture shows the RepRap GUI with an STL file loaded (this is clearly a silly orientation in which to build this block-like object, but it lets me slice the logo...). Inset is the cross-section generated near the top of the block when the "Produce" button is pressed (the purple rectangles can be ignored - they're for debugging).

At the moment the information is an unstructured list of line segments. Now to add some structure so the extruder can follow it...

Godzilla y-axis meets the Frankenmotor...

Sunday, 11th June 2006 by Forrest Higgs

I was going to get up in the morning and hook up the Frankenmotor to the y-axis tower. About 2130, however, I decided what the hell the night is young.

There was quite a bit of drama. The coupling nut that I am using as the basis of my thrust collar was rather tight on the drive shaft and tended to seize up. I ran it by itself for a while till the jagged chunks wore off and then greased the threaded drive rod and exercised the coupling nut by itself some more.

Then it turned out that the wooden collar that I'd built was too tight as well. I replaced one of the brass screws, something I'll never use again since the darned things tend to strip their heads on my Phillips head screwdriver (What DO Brits call a cross profile screwdriver, anyway? I used to know. For the Swedes it was a kryssskruvmejsel which was straightforward enough.) . Americans tend to name tools after the first company that made a particular tool.... Skill Saw, Phillips head screwdriver, Crescent wrench (adjustable spanner), and etc.

Here's a videoclip of the Godzilla y-axis plus Frankenmotor in action.

The y-axis motion was a little jumpy, though that smoothed out the more I ran it. Note the brass flathead screw that I've balanced upright on its head on the x-axis Frankenmotor mounting block in the video clip. We've got some vibration for right now in the Y-axis translation, but not much as you can see because the screw is happy to remain upright. :-)

Godzilla y-axis towers strung up!

Sunday, 11th June 2006 by Forrest Higgs

The y-axis (vertical) towers are now operating on one motor thanks to Ed and his excursion into cabling. :-)



All it is is a huge 3D parallel bar of the sort you used to find attached to rooms full of drafting tables in any engineering or architecture school on the planet.



The parallel bar always had a little plastic cover over it so that you wouldn't get your fingers or tie tangled in the cable crossing in the middle.



It's idiotically simple. Just my style! :-D

Just like a parallel bar you can raise or lower the whole x-axis bridge with a two fingers. When I rig the other side of the x-axis bridge I suspect that you will be able to use one finger. You can see

that white bar of PTFE that I have supporting it over on the drive (left) side of Godzilla. There's not enough friction in the rig to keep in in place. No big deal.

You gave up too soon on cabling, Ed! It works great, you just have to keep it simple. :-)

I installed the cabling and pulleys on the back side and I can indeed now lift it with one finger.



Of course, I can also straight arm 50 lb bags of horse cubes with left hand, too, so maybe that doesn't mean a whole lot. I learned that little trick 5-6 years ago when I broke my right forearm in 8 pieces and all the same had to look after a hungry appaloosa who didn't want to hear about sick and looking after his own breakfast and sanitary arrangements. Fortunately, the hardware that they screwed all the bits too was pretty much non-ferrous and doesn't set off airport metal alarms.

In any case, the x-axis bridge is balanced much more evenly now. The additional cabling put a little more resistance in the system so that when I let go of it it descends slowly by itself. I expect that once I hook up the thrust collar on the threaded drive rod it will stay put at whatever level I decide to park it at.



Motors in the morning and maybe a design charrette on that piston driven filament extruder that Vik has developed a hankering for till the new PICs and parts come in. :-)

First Complete Object & Tower of Ooze

Tuesday, 13th June 2006 by Vik Olliver

Using card stuck to glass as a deposition base in Da Witch, I managed to persuade the RepRap to output a full 5mm thick sample hexagon - solid yet, without gaps - with no manual intervention whatsoever. It's a bit rough but I'm pretty pleased about it, and here's the photo to prove it:

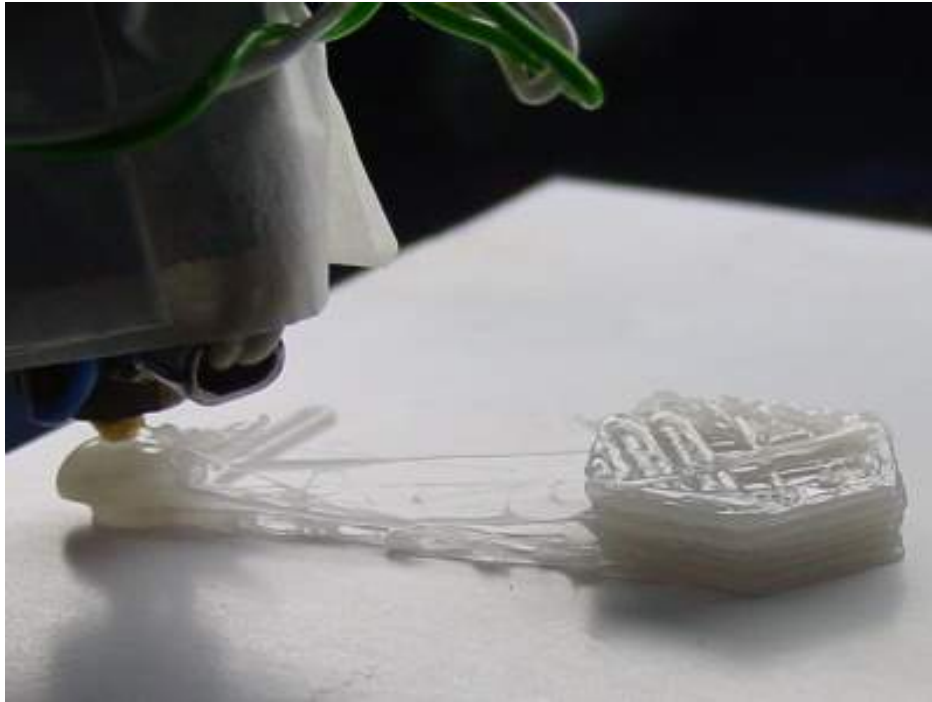

The stuff on the left is the "Tower of Ooze" that is created as the nozzle, conveniently moved over this spot for the purpose, dribbles as it warms up. The tower sticks well to the card, solving the problem of using glass whereby the Tower of Ooze elopes with the hot print head and runs off across the deposition surface. Adhering to the card also stops the workpiece curling up like an old sandwich.

Vik :v)

Thinking about making filament again...

Wednesday, 14th June 2006 by Forrest Higgs

Okay, I have a couple of days till the PIC's arrive and Vik brought up the point of there being a developing need for filament production, so I've been thinking about it enough the I want to throw out what may be an approach for you all.

As you know, I was very excited about and did a lot of work on an auger extruder for filament. I got unexcited instantly when I found out how much better filament a simple piston design did the job.

The auger design I did requires powdered polymer unless you go up to the sort of auger diameters that Adrian used. As well, the auger design that I did wanted being broken down and cleaned practically every time you used it if you wanted good results. It also had problems with bridging of polymer powder jamming the feed hopper and any number of other maladies. It was basically German design, attractive but complicated and requiring rather careful use when what we need is Russian design, primitive, ugly and utterly reliable.

What I was using looked very much like a standard ASTM standard test rig for determining polymer melt index.

MELT INDEX (OR MELT FLOW INDEX)

A very simple form of a capillary viscometer is the melt indexer that operates with a prescribed weight, pushing a polymer melt through a die of prescribed dimensions (according to an ASTM standard).

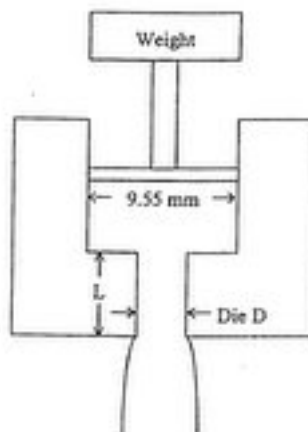

I got the illustration from a lab manual used up at McMaster University. You can see the full document here.

<http://chemeng.mcmaster.ca/courses/che412/labmodules/polymer.pdf>

It's a nice concept except that it's a one shot device and looks to be a pig to use on a production basis if the user's manual is any guide.

Adrian was talking about using a pressure cooker some time ago and I had thought along the same lines as well. Taking the bare essentials from that idea, what would happen if we just tossed our scrap CAPA in a pot and heated it. Don't get lost in the details of how to heat the pot just yet, just assume that we can do it without scorching.... use a double boiler or something. :-)

Okay, so we've got this heated pot of scrap polymer. After a while the bits melt into a big puddle, the polymer slumps down (very slowly given its viscosity) . Now suppose we've drilled a hole in the side of the pot way down at the bottom well under the level of the molten polymer.

Then we start plumbing up a two stroke pump using Adrian's favourite plumbing parts. :-)

Here's roughly what the intake stroke looks like...

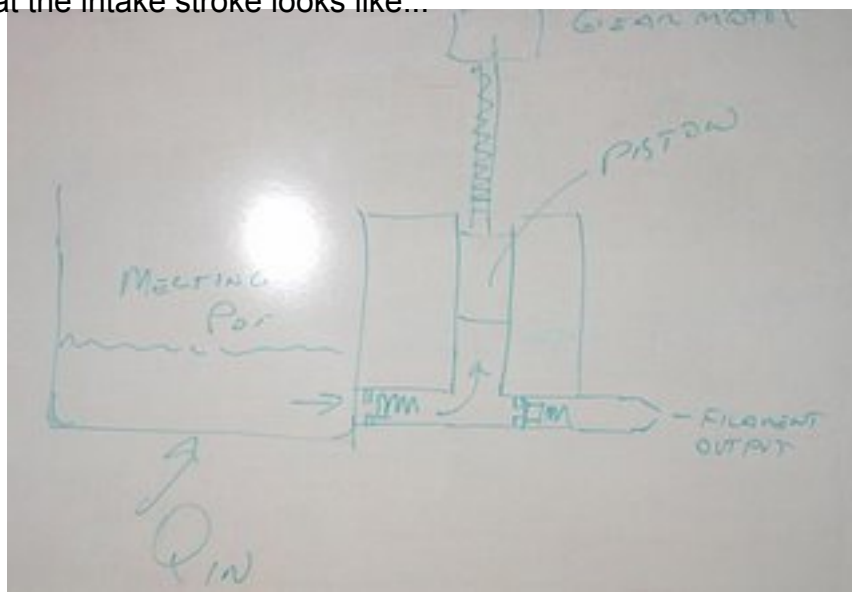

Pardon the illustration. I drew it on my white board and photographed it. That's not a great presentation method, but I'm in a hurry.

Your pot's on the left and the piston of your pump is driven by a gear motor that runs a threaded rod arrangement. I didn't get too specific on how that all fits together. At this point what is relevant is that we have what amounts to a linear motor that can deliver a LOT of thrust.

You can see two spring loaded back pressure valves. On the intake stroke the valve to the pot opens up letting the polymer melt be drawn in as the piston is pulled upwards in the cylinder.

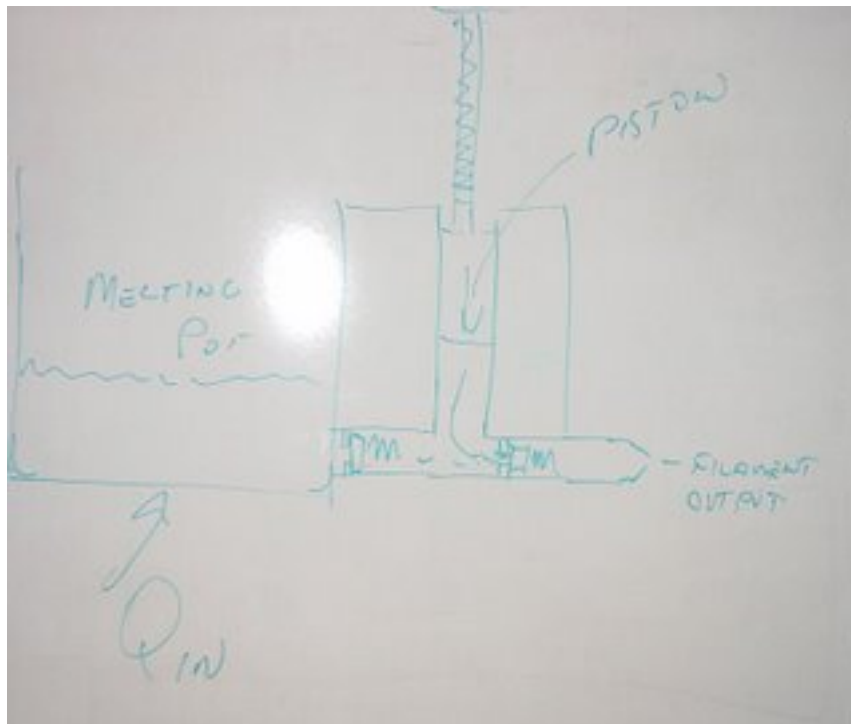

Once your cylinder is full you reverse the rotation of the gear motor which closes the back pressure valve into the pot and opens the valve to the extruder tip.

That's basically it.

What's nice is that this system can operate VERY slowly to take into account the high viscosity of the polymer melt. It can also extrude specific amounts of polymer with a high degree of accuracy. Knowing the mass flow rate of polymer out of the extruder on a real-time basis lets us control a conveyer that takes the extruded polymer away.

That's my first cut at a filament extruder.

- It can deal with either scrap polymer or virgin resin.
 - It is highly controllable and information rich thereby
 - It can largely be made of plumbing parts if we wish
- Feedback?

Fine tuning Godzilla...

Wednesday, 14th June 2006 by Forrest Higgs

As parts have worn in Godzilla is translating more and more smoothly. The big plus is that the Frankenmotors draw much less current now, I'm suspecting less than 4 amps on the basis that the motor housings no longer warm more than a very few degrees over air temperature.

I had a clatter and some bumpy movement in the powered y-axis tower. Today I broke it down and discovered that the coupling nut in the thrust collar was a bit loose in its housing and slipping occasionally, which was what was causing the clatter. Wrapping the coupling nut in a bit of duct tape smoothed that right out.

The translation of the extruder platform on the x-axis has smoothed out but oddly still doesn't go any faster than it did before.

Duct tape has proved more than adequate to connect the Frankenmotors and the threaded drive shafts.

It took a while to get the balance between cable tension in the force transfer system between the two z-axis modules and added load on the Frankenmotor driving the stage. When I first set the z-axis stage cabling up I was getting about 0.7 mm of wag between the powered and cable-driven halves of the stage. I wasn't particularly worried about that in that the wag was very predictable and could have been numerically accounted for in a calibration routine. Today, however, now that the z-axis has worn in I was able to safely increase the cable tension until the wag between modules was too small to measure with my calipers. Having no detectable wag makes life considerably easier.

First crude attempts at calibration...

Thursday, 15th June 2006 by Forrest Higgs

I've been worried that the unpowered side of the z-axis platform might be lagging behind the powered side, creating a wag. I tried measuring this yesterday by marking one the near edge of both y-axis towers on their guide bar and do it when the z-axis moves out and marking it again when it came back. The wag should have been half of the difference between the gap on the unpowered side minus the gap on the powered side.

That exercise seemed to show about a 1.2 mm wag. I tightened the z-axis cables after that and the wag seemed to have gone away.

This evening I decided to take a more direct approach, so I just taped down several sheets of typing paper and taped a mechanical pencil to the x-axis platform. I then drew a line from the powered side to the unpowered side when the z-axis platform had been moving out and again when I moved it back, capturing both sides of the wag. I then used my calipers to measure the distance between the lines at either end to calculate the wag.

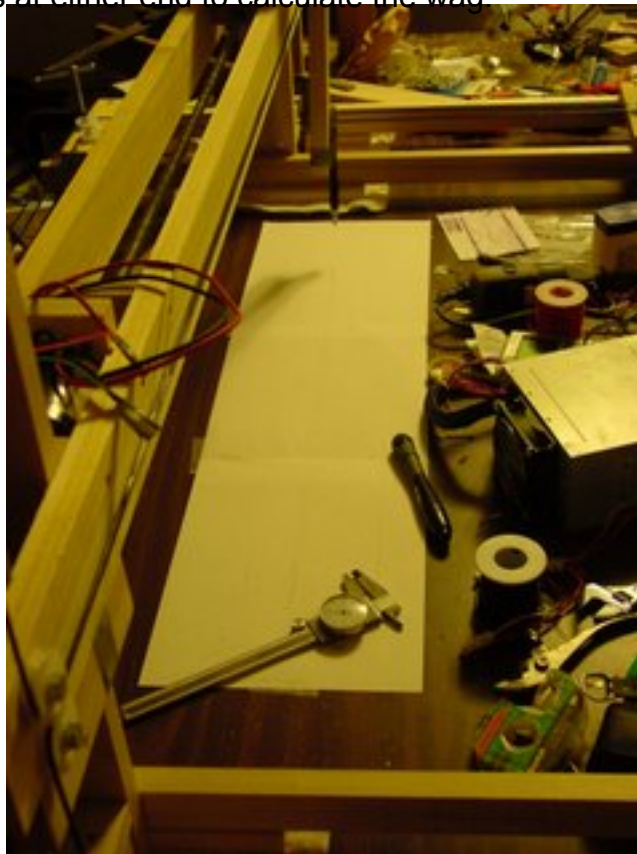

The wag seemed to be less than the 0.5 mm width of the pencil line, which is to say, unmeasurable.

I had the idea today that if I put limits switches on both sides of the z-axis platform that ought,

along with information from the rotary encoder, to be enough data to develop correction coefficients for the z-axis.

I also disassembled the z-axis to see how much play was in the coupling nut. Interestingly, there is very little if any play along the axis of of the threaded rod. The nut can, however, be rattled in position on the threaded rod slightly. It's not an antibacklash fitting, but it's not bad.

One thing that I did spot is that I have a bit of vibration in the x-axis platform. The mechanical pencil faithfully recorded it like my very own little seismograph. The amplitude of the vibration was about 0.64 mm.

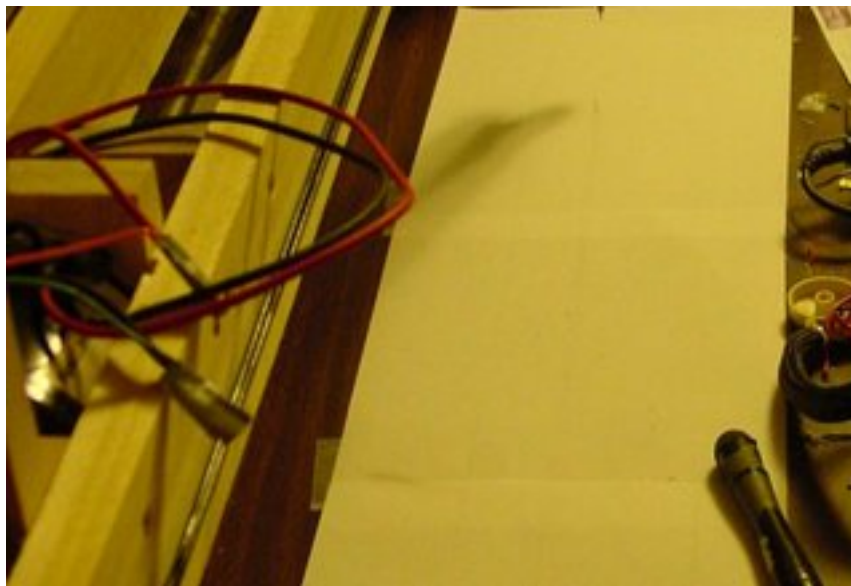

I am going to have to smooth out the action of the x-axis platform a bit. That shouldn't be too difficult.

I ran a similar test with the z-axis looking for vibration. There was no visible vibration in the z-axis translation.

UPDATE ON X-AXIS VIBRATION: A little block of PTFE taped onto the vertical pencil mounting block serving as a guide on the x-axis side bar got rid of about 90% of the vibration at the mechanical pencil point. It will be very easy to sort out.

Vik doing Reprap when he should be resting his back...

Friday, 16th June 2006 by Vik Olliver



Image not found.

This is a test hexagon done with Adrians new CSG code. Ash (who is typing this) and Vik used a 0.8mm nozzle at 140C to print this 20mm x 5mm hexagon. There is an interesting and consistent defect which the keen student may wish to analyse.



Image not found.

We believe this is caused by the nozzle trailing its contents out as it hovers around the workpiece while its not meant to be printing. It takes a while to fill the nozzle and the gap between the nozzle and the workpiece. During this time the head currently moves. Perhaps it shouldn't.

Ash
(with Vik hovering over his shoulder)

Heresy?

Saturday, 17th June 2006 by Forrest Higgs

If you scrape away all the idealism what we seem to be doing here is as simple as making a CNC positioning system that mounts a polymer extrusion tool instead of a more conventional tool head.

We have a brilliant design for a room temperature polymer extruder. It wants to use filament which is not a terrifically difficult technical problem to solve. The rest of the stuff that we're doing is, when you get right down to it, nothing more than the same problems that the rest of the hobby CNC community are addressing every day in a million different ways.

Cool! :-D

How did I get here? A few days ago one of the people who occasionally comments on what we do on this blog noted that what he sees CDC machines doing most often is making parts for for other CNC machines. That thought has been rooting around in my mind like a kanker ever since.

Shortly after that in responding to a comment on one of my blog postings I did a recap of a quick quantity survey on the poplar that had been used in Godzilla. What jumped out at me is that if I had a proper workshop I could have made it out of rough poplar that cost maybe US\$30 rather than the milled, expensive pieces costing maybe US\$100-150 that I bought that suited my hand saw and mitre box.

What didn't hit me until this morning is that if I mount my Dremel tool with a cutting head on it on Godzilla instead of a Mk II extruder...I have a proper workshop...

Letting the other shoe drop the natural question arises that if you can replicate the structure of Godzilla out of U\$30 of poplar why should you want to insist on doing it instead with maybe US\$75 worth of caprolactone?

I think the melts I did in my toaster oven started me thinking in this direction. It is a simple matter to melt HDPE into quite a respectable ingot (this is even easier to do with caprolactone) whereas making the same HDPE into filament that will run in something like a Mk II is a lot more trouble. Why not mill the ingot into what you want and save the swarf instead of making everything into filament and trying to extrude everything.

Similarly, Simon, if I recall correctly, was talking about setting up a furnace capable of melting aluminum. Those aren't hard to make. Why not use aluminum in a RepRap? You can make a cupola furnace that will melt steel into ingots for not a lot more. Why not use steel in a RepRap?

After all, we do already anyway, don't we?

If you think of a RepRap as a CNC machine that has a bunch of tool heads, an extruder being only one of many, the whole concept gets a lot more flexible and interesting to me. :-)

Testing assumptions about polymer melts...

Saturday, 17th June 2006 by Forrest Higgs

The first assumption that I tested vis a vis the proposed filament method was whether I could melt polymer bits in a pot



The short answer is that you can, if you put the pot in an oven where it gets heated evenly. The leftmost sample is caprolactone whilst the right is HDPE. The HDPE sample was brownish because the bits used in the melt were cut with a rusty saw. It makes for a nice marbled appearance. The caprolactone was heated for 30 minutes at 130 degrees Celsius while the HDPE was also heated for 30 minutes but at 160 degrees.

The corelle ware cup at the top right was the crucible for the melts. Corelle ware has the advantage that plastics do not adhere to it.

While I was at Santa Barbara yesterday and today I asked myself whether if you simply powered a capillary viscometer instead of putting a weighted piston on top of the polymer melt if you couldn't efficiently make filament.

The numbers seem to work. A polymer melt can easily be done in a cylinder with internal dimensions of 50 mm diameter x 100 mm height. That much melt, converted to filament, would let the Mk II operate for about 70 hours at 4 mm/sec.

I am going to go look at plumbing and piping parts this weekend and cobble something together. :-
)

Peristaltic Polyfilla

Monday, 19th June 2006 by Adrian Bowyer

Zach suggested using a peristaltic pump for room-temperature RepRap extruders. This is nice because it should be very easy to make one using rapid prototyping. But I thought that a problem might be that the flow would be too pulsed.

Time for an experiment:



I stole an old peristaltic pump (temporarily) from colleagues in Biology & Biochemistry, filled a syringe with the same Polyfilla that James used for his experiments, and set it running. Here's a (slightly out-of-focus) close-up:



The direction of rotation was as the red arrow indicates, and you can see a void behind the roller ringed in red. The suction created caused some of the liquid in the Polyfilla to vapourise. Unsurprisingly, the stream out was very intermittent.

Then I put a pressure on the syringe (in a real design, this could easily be done with a weight):



The result was a smooth flow with no interruptions. The soft tube did tend to drift round the pump in the direction of rotation, but in a real design it should be easy to anchor.

So. Off to design an RP peristaltic pump...

More work on the Mk IIa...

Wednesday, 21st June 2006 by Forrest Higgs

I had a few moments and made up the threaded drive shaft for the Mk II out of 1/4-24 threaded rod.



First try at filament...

Wednesday, 21st June 2006 by Forrest Higgs

I got up early and made the little poplar piston after a bit of sawing, rasping and then fine shaping with my Dremel hand tool. I had a piece of scrap poplar left over from a particularly clumsy attempt to make a Frankenmotor mount that worked as a seat for the extruder barrel.

Here goes...

Here's a view of the very complex 2.77mm extrusion orifice....



...and the super sophisticated method for avoiding dribble during the heating cycle.



...and how I'm going to keep it upright in the toaster oven



Now we prep to charge the extruder... very tricky



A tablespoon was used for charging the extruder barrel...



Here you can see the famous toaster oven with the extruder inside and the IR thermometer laying on it's door.



And away we go...



It took only a few moments for the caprolactone to hit 60 degrees and go virtually transparent.



An hour later I locked the extruder barrel in my vise and inserted the poplar piston.



As I expected I had to apply a considerable amount of pressure to get an extrusion going. I got about a metre of good filament out before the extruder barrel extruded to a point where there was more pressure required than I could apply to the piston.

I let the filament hang free and it stretched a bit as a result. If I corrected for the stretch I suspect that I got about 750 mm of 3 mm filament. The quality and shape was excellent. It was the same colour as the granules, had a round cross-section and coiled quite easily.

One bubble about 50 mm into the extrusion exercise was serious enough to cause a structural break in the filament. Other bubbles were so small that they popped and the filament healed. This same phenomena was observed in experiments with the auger extruder done some months ago.



I did a second extrusion and quenched it in water. I got another metre yield with a lot less gravity stretching. Diameter varied between 2.75 and 3.05 mm.

My son was watching the extrusion and noticed something of good interest. He noted that bubbles were happening when I let off pressure on the piston for a moment and the extruder drew air into the cylinder through the extruder orifice.

Shopping...

Wednesday, 21st June 2006 by Forrest Higgs

The new PIC programmer is on order and should be here by Thursday or Friday. Randy at Glitchbuster is just over the state line in Nevada right by Lake Tahoe.

In the meantime I put all the Mk II parts in a ziplock and headed down to the hardware supply store.

The M3 bolts aren't readily available in the lengths that Adrian specified, nor is M5 studding.

I was able to match M3 bolts pretty closely with American machine bolts size 10-40 and while 1/4-inch American studding is a bit bigger than M5 (a bit of widening of the cavity will be required) the pitch of the threads is virtually identical ($20/\text{inch} = 0.79$ metric pitch while M5 has 0.8 pitch).

Here's the Americanised Mk II bolted together

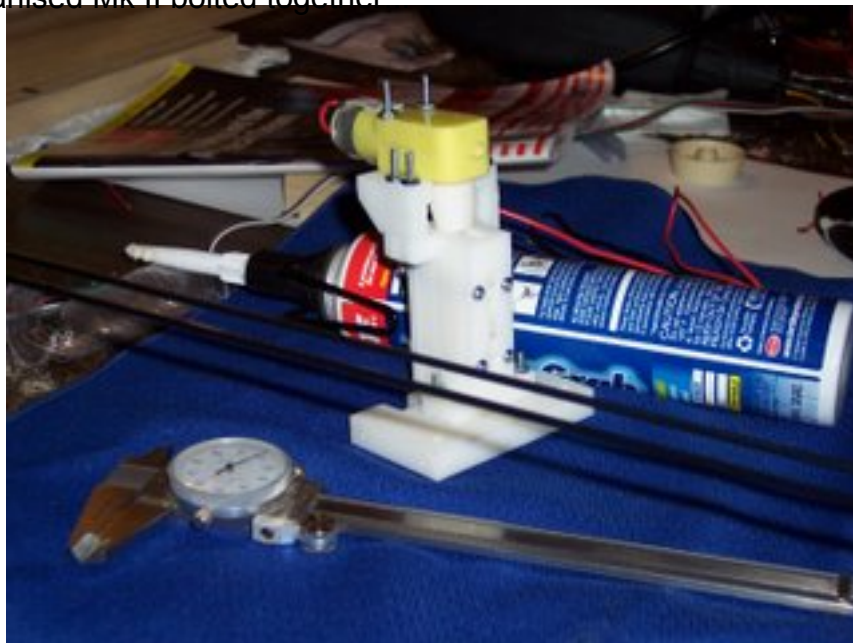

I decided to simply size up my piston extruder concept. I hit the plumbing section of the hardware store and discovered that steel pipe is welded seam and the seams are NASTY, so I went for brass.

I tapped the cap with the same 7/64-inch drill bit that produced 3.15 mm diameter filament in earlier experiments. Interestingly, the cap thickness is no more than 2 mm.

I will be buying a few 16F877A's for running the Mk II so that I don't have to be so clever in

measuring things like thermistors and Hall-effect chips



I'm planning on making a piston out of the ubiquitous poplar and also make a poplar bracing rack for it in the toaster oven with a bamboo plug for the extrusion orifice. This one is a 22 mm diameter x 52 mm. It holds 19.3 cm³ of polymer which is enough for 2.7 metres of filament which will keep the Mk II going for a bit over 2 hours and 30 minutes at 4 mm/sec.

Basically, you fill it with polymer pellets, pop it in the toaster oven and when it's ready take it out and extrude filament.

This one I plan to run by hand again and, if I get promising results, attach to the Siemens gearmotor to it using the thrust design that Brett put together some months ago.

MELabs USB PIC programmer board arrived...

Friday, 23rd June 2006 by Forrest Higgs

YEA! The new programmer board arrived! :-D



Better yet, all of those dead PIC16F628A chips weren't dead after all, so now I have LOTS of PIC chips! I've been reprogramming them with good hex files and testing them. :-)

It was definitely something wrong either within the JDM board or the two PC's I tried to run it on didn't provide enough voltage to properly program PICs. I suspect that it was that last.

From what I've been able to read the USB port has a more reliable source of current that can be tapped for programming than the RS232 port does.

As well, the new board uses a USB port which means I don't have to crawl around under my desk hooking up RS232 connectors any more.

Now I can see if I can get the motor controller routine and the serial comms routine working together on the motor controller board. It will also be fun to try to get the AS5035 magnetic encoder chip going, too. :-D

Happy Birthday to ME! :-D

Got direction and speed going for the little yellow G4 motor...

Sunday, 25th June 2006 by Forrest Higgs

I'm beginning to get the knack of writing hex code in Oshonsoft Basic. My code is still probably a LOT more awkward than it could be, but I'm getting the job done. :-D

Taking a cue from Simon's bipolar stepper programme I put a slider bar in my VB.NET serial comms programme to control speed and radio buttons to control direction.

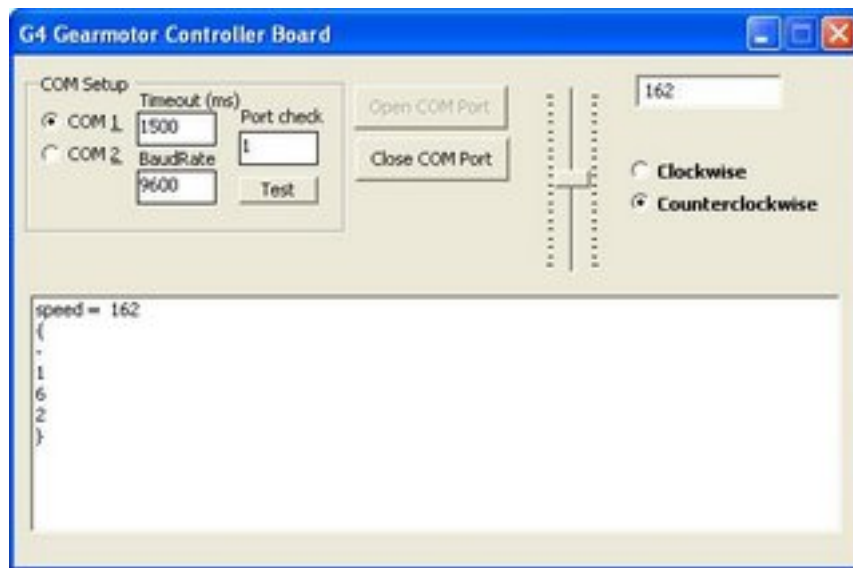

The API for doing the job is extremely simpleminded and intended only for this bit of testing. What gets squirted out on the serial loop looks like...

```
{(direction, +/-)(speed, 0-255)}
```

A typical command to tell the control board to rotate the G4 counterclockwise at a PWM setting of 200 would look like...

```
{-200}
```

The BASIC code to set direction and speed can be got from my personal server for anybody who's interested in looking at my retarded firmware programming style. :-)

If you want the VB.NET code let me know in the comments on this blog entry and I'll zip up a copy, put it on my server and post a link. I personally think that it's way too early for anybody to try emulating what I'm doing. It might not even be a good idea. :-s

0.5mm Layers and Cooling

Tuesday, 27th June 2006 by Vik Olliver

I'm back on light duty after a lower back injury, and firing up the experiments. In the picture below, you'll see two 16mm test hexagonal prisms, now being extruded from layers a mere 0.5mm thick. The one on the left was done contiguously, the one on the right was sprayed with freezer spray to completely solidify it between layers:



Image not found.

Unfortunately, the cooled one detached from the base and tried to impale itself on the nozzle, so I had to halt the experiment. However, you can clearly see that the distortions are drastically reduced when the lower layers are cooled, and fusion is still good. Hopefully, this will lay to rest any concerns that we might have to do the deposition in a heated environment.

I see Simon has already added a reserved output pin to the PIC for driving a fan in the Wiki. Over the weekend I plan to test deposition on sandpaper, and to try and roughen the glass surface with hair spray. I've tried crosshatching the glass with a diamond scribe, but that didn't seem to help as per above.

Vik :v)

Setting up for shaft encoding tests

Tuesday, 27th June 2006 by Forrest Higgs

I finally got my nerves steady enough to do the fiddly soldering for the Austriamicrosystems magnetic shaft encoder. I used thin copper filament that I liberated from some #20 multifilament copper wire for the connections.

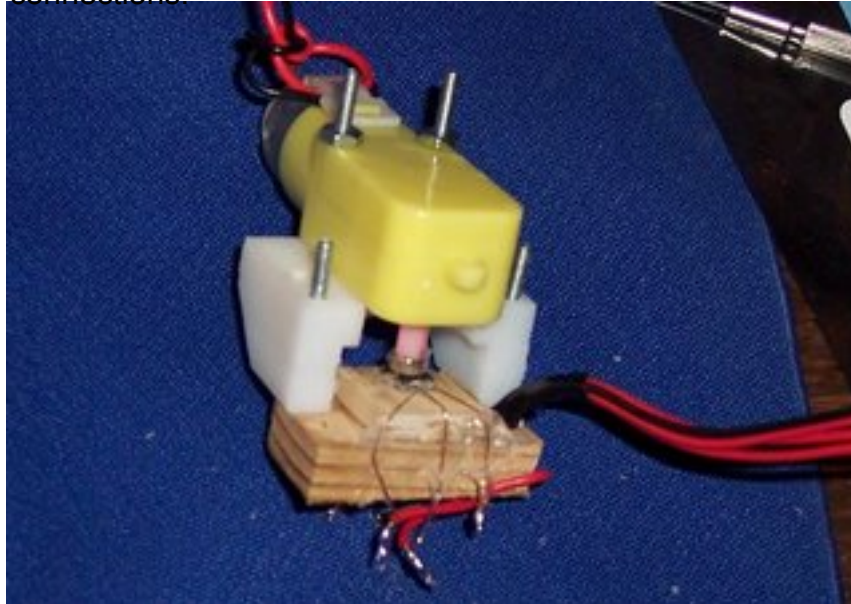

I'm hoping that before the end of the year I'll be able to whip out polymer parts with Godzilla like Adrian does with the departmental Stratasys. For now, though, I'm repstrapping everything, so I used some scraps of Japanese plywood cut from a throwaway wood tray that I got with a log of naruto (Japanese fish cake).

Silicone caulking secured the chip and both insulated the filaments and gave them a firm footing on the bulkhead so that I could solder leads back to the controller board. I also used the same tube of silicone caulking to seat the magnet on the drive shaft. That caulking is nice stuff in that it allows you to attach things to each other without marring their surfaces. When I want that encoder chip back all I have to do is peel the silicone off of it. :-)

I've got a consulting deadline to meet before I can get back to doing the programming for this. It will probably be the weekend before I'll have a chance to get at it. Hopefully, I'll be able to test some programming for those Hamamatsu chips for limits detectors as well then.

Randy got busy doing something so I still haven't heard back on when my L298N dual darlington will be shipped or whether he's going to put the 16F877A's in the same shipment. I hope Radio Shack still has some heat sinks and that they'll go with the L298N's. The darned heat sinks cost as much as the chips. :-)

ARNIE gets studding, and goes up...

Thursday, 29th June 2006 by eD

So the string idea got binned. And now ARNIE (mk 2) falls in line with Vik and Forrest's creations... the z-bed is now powered with a studding transmission!

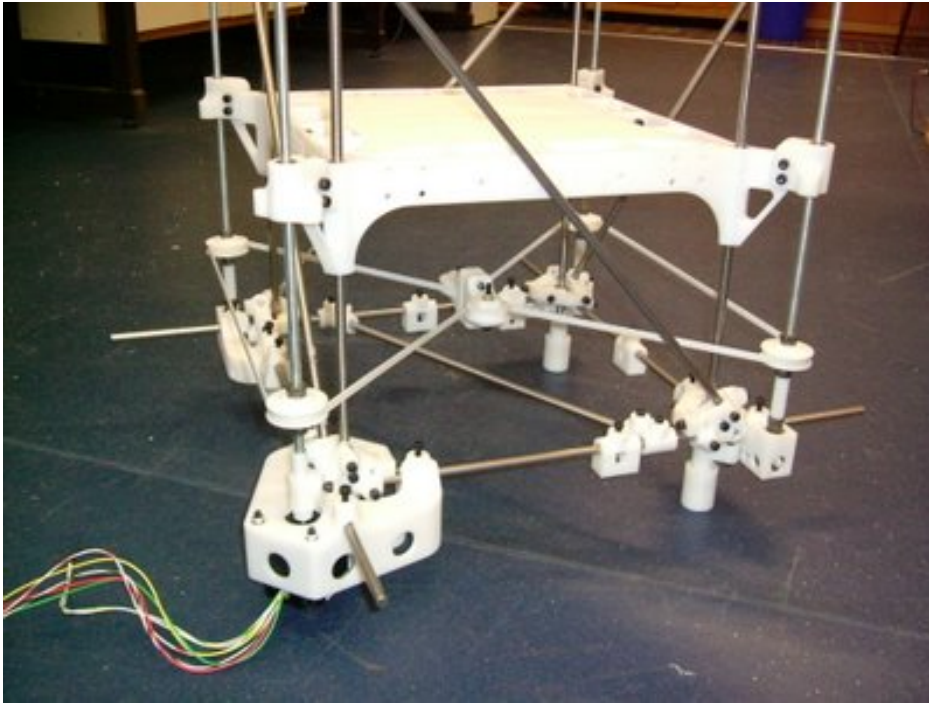

It's a retro fit to mk 1, and so hideously bulky, but very repeatable and reliable. It's a good proof of principle for this arrangement before we move on to Mk 3 which now will certainly use studding for the verticle tranmission.

String's still in the wings for ARNIE's x&y because of its potential speed (compared to screw threads). Hopefully that'll put the rapid into RP.

Fan-boys and hairspray

Sunday, 2nd July 2006 by Vik Olliver

I've hooked up a 6 inch 12V cooling fan over the workpiece, manually operated for the moment. Cools everything down in about 15 seconds - including the extruder, causing many reheat pauses and making deposition proceed at a glacial rate. I tried giving it 8 seconds of cooling, but that's not good enough. The objects come out all distorted still. It has to be cooled solid. Looks like some ducting is needed to avoid cooling the extruder too much, and maybe a smaller fan would be better.

In an attempt to make things stick to the glass substrate, I sprayed the glass with a thin layer of "extra firm" hairspray purchased specially for the occasion. To the touch, it feels much less slippery. In operation, the plastic deposits fine onto it.

The problem comes with the new cooling. This causes the plastic to shrink slightly, and I suspect that this is causing the break in adhesion on any relatively rigid surface be it glass or hairspray lacquer.

Too little adhesion, and things curl up. Too much adhesion and you'll never get the blooming thing of. So, I have obtained a range of different sandpapers, and over the coming week (once I've fiddled with the fan and ducting a bit) will attempt a series of cooled depositions on the various grits.

Vik :v)

We got shaft encoder pulses on the PIC!

Monday, 3rd July 2006 by Forrest Higgs

It took a fried PIC and a bunch of soldering, but I am reading encoder pulses off of the Austria Microsystems AS5035 chip that is tracking the rotation of the little yellow G4 gearmotor via a magnet glued to the end of the drive shaft.

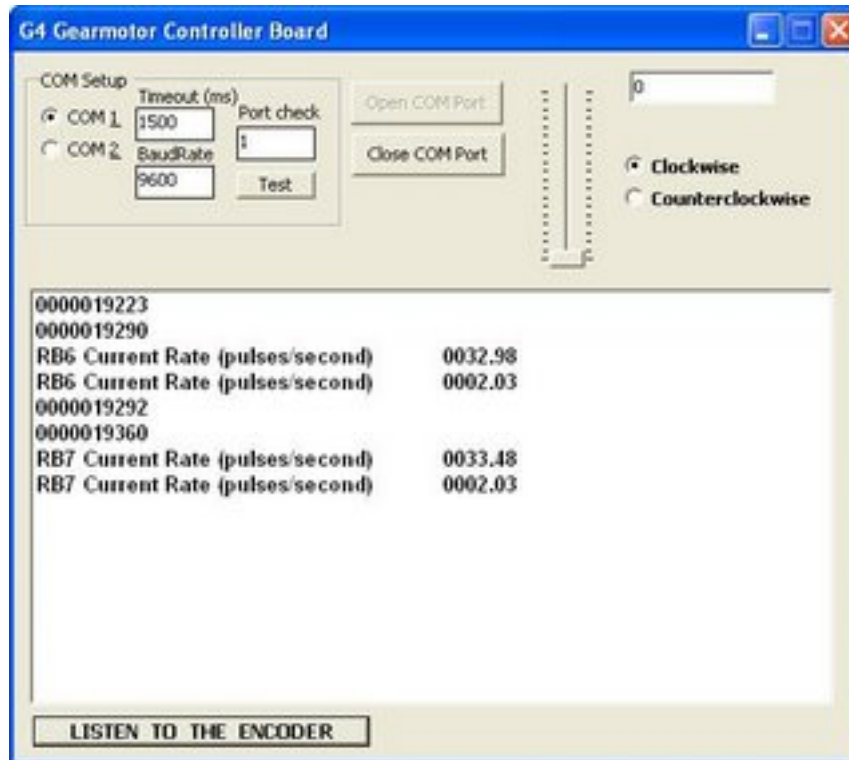

I got interrupt-driven sampling of the output off of the encoder chip going after a session with a much simpler test board revealed that what I was doing wrong with making interrupts work had nothing to do with my PIC programming but rather my soldering.

That last problem that cost me so much time was not remembering that I leave "unused" pins on the PIC socket dry on the stripboard. I'd built the board when I was trying to use PWM to control the rotational speed of the G4. When I soldered the dry joints on the new connections from the encoder chip things started working fine.

Once I did that the PIC simulator's results began to look like what the control board was giving me.

I've got both pin RB6 and pin RB7 passing pulse counts to my PC. Next is to get the direction and after that to go after Adrian's idea of feeding a speed and destination to the board and having the board do it. :-)

ARNIE z-run performance

Tuesday, 4th July 2006 by eD

ARNIE's studding transmission upgrade was tested on Friday. The stepper motor was directed to rotate 1000 steps and back again 10 times with a delay of 100 cycles per step. A calliper was used to measure the position of the z-bed at the start and end of each run. The figure below shows the results for this test.

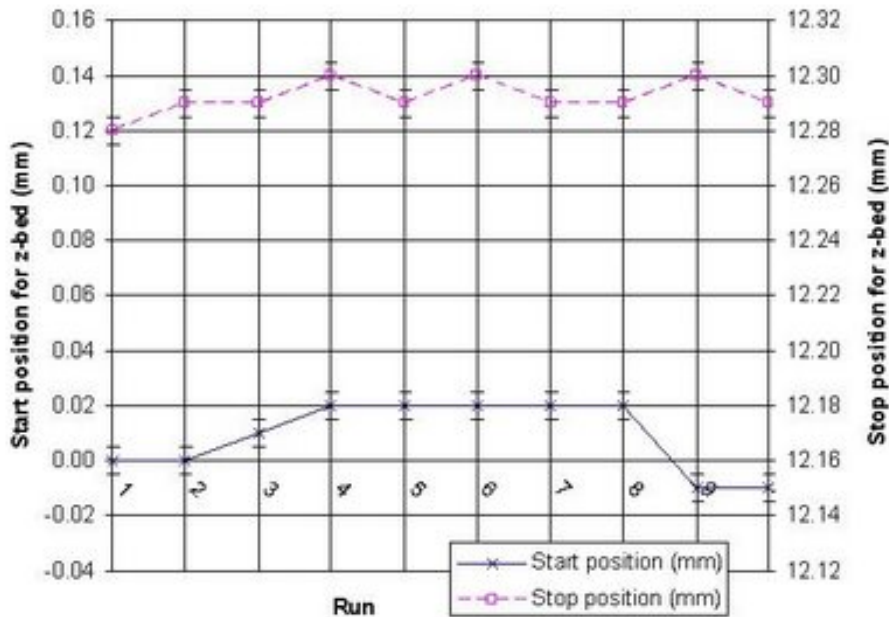

It shows a variation of ± 0.04 mm and ± 0.03 mm variation for both start and end positions respectively using the studding transmission for the z-bed. Not bad, 'specially since we're aiming for an initial accuracy of 0.1 mm. Happy days.

Done with shaft encoding...

Wednesday, 5th July 2006 by Forrest Higgs

I got the firmware for the little yellow G4 and the AS5035 shaft encoder doing what I wanted last night. We've got direction and speed control via PWM and feedback on both via the AS5035 chip. The shaft encoder chip is everything that Vik and Adrian said it was.

I have some L298N H-bridge chips on order, but my supplier seems to have gone on Summer holiday, so I'm stuck there unless I want to reorder from Mouser or Digipen. Using what I know to run the Frankenmotor seems to be the next logical step, except that the L298N's that I need for that are not in hand yet.

If Randy stays gone for a few more days I'll see if I can get interrupt-driven serial comms going and maybe try out those Hamamatsu chips for limits detection.

One thing that's become rather obvious is that I want to do more firmware programming than there is memory in the 16F628A. I'm currently up to 1.4K out of 2K available. I've ordered some 16F877A's which have 8K and cost roughly twice what the 16F628A does. The only drawback to those is that you absolutely have to use an external clock chip with the 877A and those run cost as much as a 16F628A. Anyhow, that lets me to use 20 MHz which gives me 5 times the processing power.

I'll be swapping over to the 18F chip family pretty quickly, though. Those come with up to 64K memory and on-board 8 MHz crystals at about US\$4-5/unit. They also have lots of port pins and A/D channels to boot. They also give me USB capability.

True Grit

Wednesday, 5th July 2006 by Vik Olliver

Encouraged by the great performance of Ed's Z axis, I've fired up an experiment he's been asking for. I've done an extrusion on 240 grit sandpaper (some ask about the scale; the hexagon is 16mm (0.63") in diameter):



Image not found.

Note the relatively well-formed sides, extruded as 0.5mm thick layers. Between each layer, the fan was manually run while the outline was being printed. This seemed to cool things off enough, though there's no ducting to protect the heater yet. As expected, the polymer stuck to the sandpaper like, well, glue sticking to sandpaper really. Of course, the sandpaper is stuck to the glass sheet with glue to keep it flat. The Tower Of Ooze (right) came off OK, but the hexagon was stuck solid. So I end up trying to pull things off a sheet of thin, cheap glass and you know what'll happen if I persist in doing that... Fortunately the paper tore before the glass broke.

I'll do one or two more experiments with the sandpaper - might as well use it while it's stuck there - before washing the glue/sandpaper off and trying a different size grit.

Vik :v)

Peristaltic pump go after all!

Saturday, 8th July 2006 by Adrian Bowyer

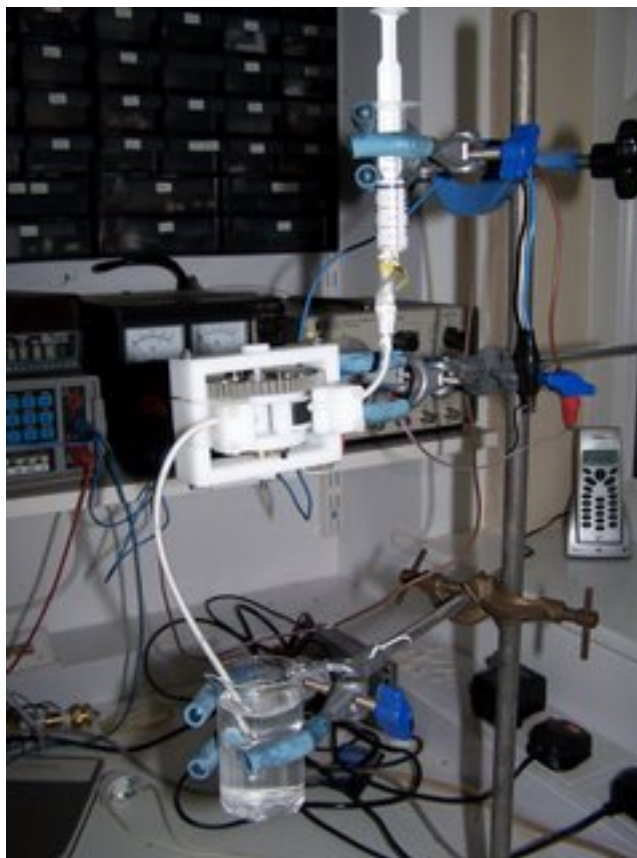

Gave up too soon (see blog right below)...

Jonored's neat idea (see the comments on that blog entry) prompted another experiment. Instead of having the extruder nozzle right after the pump, I put a length of the flexible tubing after it. That acts as a pressure reservoir, and evens out the flow beautifully. (The beaker of water is just so I can park the nozzle in it, turn everything off, and go for coffee without it clogging; on a RepRap machine it would probably be a piece of damp felt in the write head's parking place.)

Now, of course, turning the pump on and off doesn't turn the flow on and off - there is a huge time delay that would be impossible to allow for in software. But I already have a really simple solenoid valve design that works by pinching a soft tube like the one in the peristaltic pump. All I need to do is to install that just before the nozzle and use that to control the flow.

The soft tube swells perceptibly under the pressure. This, of course, gives a really simple way to switch the peristaltic pump on and off - just use the swelling to trip a microswitch. No computer needed...

I'm extruding "Fine Surface Polycell Polyfilla" which seems to have near-perfect characteristics for

this (including being really cheap and being available at every DIY shop). Many thanks to my Final Year student James Low for all his work on that, which is really paying dividends. The syringe at the top of the picture is the reservoir of Polyfilla. An obvious design change is to junk this and just to run the peristaltic tube to the screw-on cap of the Polyfilla tube (which is like a giant tootpaste tube).

Here is a shot of the bits of the pump.



The gears are two that I happened to have lying around. But now that Vik and Forrest have sorted out how to RP gears (see [here](#)) they should be easy to replace. The nozzle is made from brass in just the same way as the bigger one on the [Polymorph Extruder](#). Apart from those the only non-RP parts are the motor, a couple of brass bushes, and some lengths of threaded M3 bar.

It has the ability to take one or two tubes. Two tubes could be used, for example, to carry an epoxy and its catalyst. They would be mixed in the nozzle. If two different diameters of tube are used it's easy to change the volume ratio of the mix.

The nozzle could be disposable - the first thing the RepRap machine would do at the start of a build would be to make one or two new nozzles for next time...

Peristaltic pump no go

Saturday, 8th July 2006 by Adrian Bowyer

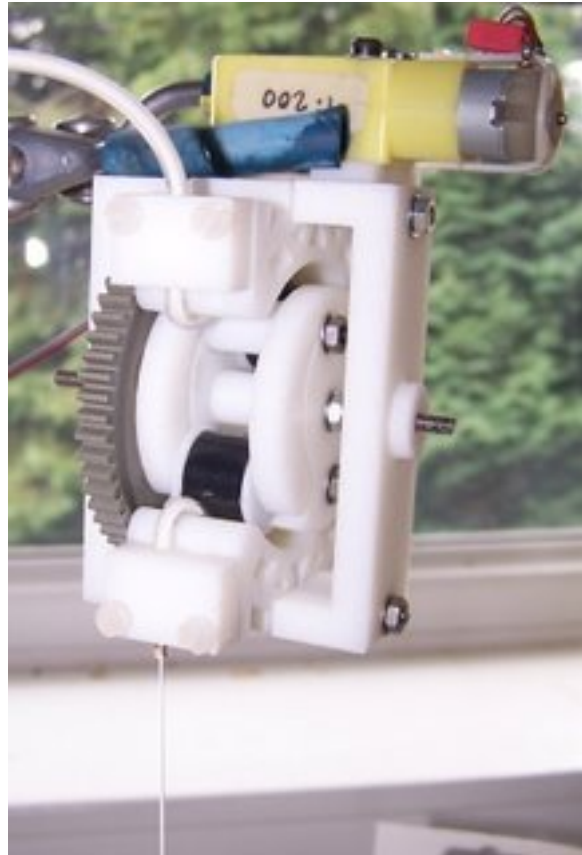

The peristaltic feeder pump for cold pastes (like Polyfilla) has a fundamental problem. Here it is working, and you can see that it produces a clean stream of paste (about 0.5 mm in diameter) at the bottom of the picture.

But the tube that forms the pump has to be flexible. This means that, when a pinch wheel goes out of contact with it, pressure is released and the back pressure from the nozzle causes the paste to rush back up the tube (which expands a little to accommodate it). So the device produces an intermittent stream - it's off half the time, and on half the time. The problem could be reduced by having more pinch wheels (my design uses two), but can never be eliminated as far as I can see. A bit of a pity, because the pump is compact and easy to make.

Back to James's driven syringe (which works...).

Printing a real part

Sunday, 9th July 2006 by Vik Olliver

So I had to cap Ed's Z-axis, Adrian's peristaltic prototyped polyfilla pumper, and Forrest's working opto interrupt. It was tough. May I present my first attempt at printing a bona fide RepRap component, the 6mm stage linkage (known as a "gripley" locally, in honour of Terry Pratchett):



Image not found.

For those who suffer more delusions of grandeur than I, the top one was made by a Stratasys from ABS and I did the skeletal one from Polymorph (must've rolled a metre of it so far today). The bottom part was extruded using the Da Witch prototype. The extrusion was made using a 0.8mm nozzle at 80C, fan-cooled by manual intermittent fan operation. The deposition was halted at 3mm, and the wall thickness is a very constant 1.0mm - at long bleedin' last!

The deposition surface was a cheap Vietnamese wooden chopping board (NZ\$3, The Warehouse), from which I had sanded off the varnish. I knew all that sandpaper would come in handy :) The old varnish, whatever it was, stuck to the polymer like glue. This might be useful, and I might get some cheap spray-on varnishes to experiment with as a light spraying on glass may provide enough adhesion. The adhesion to the base wasn't what I'd call excellent, but it was a freshly-sanded surface and some dust may have been present. We'll see how it goes; it'd rather steer clear of wood due to its tendency to warp.

Please excuse the tatty and somewhat sparse infill, but this is only the second complex object ever to have been printed and the filling algorithm needs a bit of tweaking. Nevertheless, I'm really happy with this lot. It shows we're definitely on the right track.

I suspect we may be able to make depositions like these using a ducted fan for continuous cooling. There is still lots of experimenting ahead. But time to sit back with a Cointreau & vodka, and relax for the evening I think.

Vik :v)

Well THAT was easy!

Sunday, 9th July 2006 by Forrest Higgs

No problem with the Hamamatsu photoreflexor chip. Put it on interrupt on RB6 and it ran on the third time I tried it.

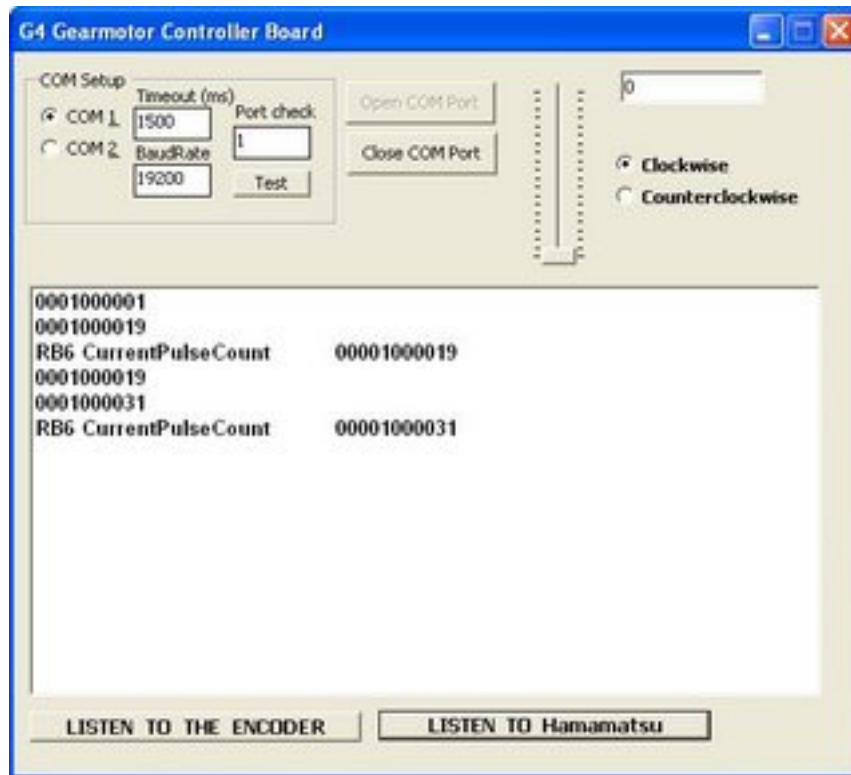

It appears that you have to be a little way away from the chip before it sees its reflected light signal. Once I understood that it was no problem getting it to pulse.

Hmmm, I'd planned on that taking longer than it did. I guess I'd better get on with trying to do interrupt-driven serial coms now.

Chips arrive!

Monday, 10th July 2006 by Forrest Higgs

The order from Randy with the L298N chips arrived this morning. I wasn't expecting them till Tuesday or Wednesday. Turns out that post from Reno is a lot faster than I expected.

It appears that Randy is going to work out nicely as a supply source. He's effectively reduced the shipping and handling overhead of buying a lot of parts from about 40-60% of the purchase cost to something like 10-15%. His prices are, as well, within a short shout of what I can buy things for from Mouser and Digipen. That lets me buy small lots of parts with a lot better financial efficiency.

I had worried because the pins of the stand-up L298N were offset by 0.05 inch instead of the standard 0.1 inch. The legs are put into two separate rows with alternating pins with one row kneed out away from the chip by maybe half an inch. It's a snap to bias that row just a hair so that they use the same pin hole row on the strip board that the other row does. That's not a wonderful solution but I expect that it will make setting them up on strip board not nearly the chore that I expected that it would be heretofore.

I also got the 40 pin 16F877A chips. They are HUGE! My dinky little stripboards won't accomodate them. Too narrow.

I guess that now I get to see if they work for the Frankenmotors.

Interrupt-driven serial comms no real challenge

Monday, 10th July 2006 by Forrest Higgs

When I finally sat down and started writing code it took about five minutes to write a test program for interrupt-driven serial comms for the 16F628A and test it on the simulator. It took another five minutes to program an actual chip, stick it in the test board and make sure that it could do a "hello world" echo. That was a lot faster development cycle than I expected last Friday.

That's the last piece in the puzzle for producing a control board for the Frankenmotors. Further progress now depends on receiving the relevant chips and actually putting one together and testing it. According to Randy that should be tomorrow or Wednesday at the latest.

I think I've now got quite a decent development suite for firmware. I program in BASIC with an integrated development environment and PIC chip simulator from Oshonsoft. Oshonsoft is run by a physics professor who lives in a little village outside of Belgrade. He charges US\$67 for an individual license. That's about 25% of the price of most other entry-level commercial, high-level language compilers. It works well.

One bit of supporting evidence that the Oshonsoft BASIC compiler is worthwhile came in at the pic_sim_ide users group at Yahoo a few days ago. Somebody has taken the trouble to write a crack that gets software pirates past its license requirement. From my experience having a crack for your app appear in the peer-to-peer filesharing world is as good as a certificate of merit. :-)

After a lot of stress and strain with my home-built JDM programmer, which I estimate cost me about US\$20 in parts and maybe US\$5,000 in distress at the end, I finally settled on a MELabs USB programmer. Their USB programmer bundled with a 40 pin ZIF socket and software cost about US\$115. It's a very "smart" PIC programmer built around a PIC18F chip. Smart is what I need. It's very forgiving of my clumsiness and foibles. For example, I get a nice error message if I get the PIC chip in backwards. I once also accidentally put a SN754410 chip in the thing and it politely told me that it definitely wasn't a PIC chip. I need that sort of backup.

While I understand completely the desire and need for using open source software and technology for RepRap in the longer run, I think that if you want to get a lot of eyes and hands on firmware development this is a fairly decent route to take.

As I said some time ago I expect that for every potential developer out there who is useful in the C language there are probably several hundred who can tinker in BASIC who might find firmware development for as focussed a piece of technology as RepRap a lot of fun. :-)

Making interchangeable nozzles.

Sunday, 16th July 2006 by Vik Olliver

I'm making a variant of the Mk2 extruder nozzle that can be easily swapped out for unclogging, different extrusion diameters and so forth. Details can be found [here](#), and this is a photo of one fitted to a heater barrel:



The heater barrel itself is wrapped in pelican wire - insulated nichrome. I'm using 16mm PTFE rod so I can get higher pressures. The 10mm rod didn't grip the barrel tightly enough when I cranked up the pressure for really small holes, even when I'd put a hose clamp around it.

Vik :v)

The RepRap mints a polo

Monday, 17th July 2006 by Vik Olliver

Adrian has improved the infill code to the point where it can now fill in the gaps in an annular object - a short, fat tube. The shape is commonly referred to in the UK as being like a Rowntree's Polo Mint ("The Mint With The Hole"), which are now sadly owned by that ethically dubious company, Nestle.

Meanwhile, back off the soap box, I've grabbed a photo of the printed polo with all the little bits of sprue snipped off. Note that about 10 o'clock there is the dreaded dimple caused by the nozzle not having any polymer left in it after it has been moving around. Really must fix that some month soon:



We have even layers, like an onion or possibly parfait. These go round corners and still manage to line up quite nicely if I say so myself. The infill can be tightened up, but I like to see where it's going. The object was cooled for 10s by a fan between layers.

The polo was meant to be 20mm in diameter. 3 random measurements give 19.5, 19.7 and 19.6mm. The centre hole was meant to be 10mm diameter and that gives (avoiding the dimple) 8.3, 9.6 and 9.1 - there's a lot of sprue so it's hard to take accurate measurements inside.

Warning: RepRap'd artificial sweets are a choking hazzard. Keep out of reach of young children and intoxicated students.

Controlling speed, direction and position of a brushed DC motor...

Tuesday, 18th July 2006 by Forrest Higgs

I finally cracked using timer 2 on the PIC16F628A chip in interrupt mode. That means that I will be able not only to keep track of where a positioning stage is but also the direction in which it moves and rate at which it moves.



While I was originally going to calculate the rate via the supervisory comms software in the PC, cracking the problem of using timer 2 in interrupt mode lets me do all that in the PIC chip and also to do it at a much, much finer resolution than would have been possible in the PC.

It's a good thing that the diodes for the Frankenmotors are due in in the morning because with the G4 gearmotor one has to use quite long sampling periods to get a good idea of the rotational rate. I suspect that the AS5040 encoder with 4096 resolution is going to be very handy in that regard with very slow gear motors like the G4.

It is going to be interesting to see if the PIC16F628A has enough memory to allow for sophisticated approaches to DC motor control. I'm not terribly worried about that though because I have the PIC16F877A as a back up with 4 times the memory. :-)

Feedback control of brushed DC motor speed

Wednesday, 19th July 2006 by Forrest Higgs

Okay, I've done part of what Adrian wanted. You tell my control board how fast you want the G4 motor to go, the units are encoder pulses per unit of time, and it takes you there and keeps you there. It keeps you within a pulse per unit of time of where you want to be.

There's a tradeoff with the G4, which runs at < 70 rpm. If you keep your unit of time low you get faster motor response, but you also get fewer pulses per unit of time and therefore less control resolution. Make the unit of time too long and you will get whatever drift in motor speed that can happen within that unit of time. You will also be slower to correct when you overshoot.

The magnitude of these problems should be tremendously smaller with the Frankenmotors since they operate at anywhere from 250 -2270 rpm.

One nice feature of the control algorithm is that if you are operating at the low end of the motor's range it will take you down to wherever the lowest speed that the motor will run rather than letting you stall.

The Great Pyramid of Pholymer

Thursday, 20th July 2006 by Vik Olliver

I tried doing a true triangular-based pyramid but the software's not quite up to it. Instead, this one has (believe it or not) a slightly flattened tip:



Image not found.

Yeeesss.... It looks like the deposition routine is dumping too much polymer in the tip of the pyramid, causing the whole thing to collapse over sideways in a sort of mini-landslide. It did a very promising start though.

The pimple, slap-bang in the middle of the photographed face (where else on an adolescent?) is caused by the head wandering off to get warm in the middle of depositing the side.

Vik :v)

A new wrinkle on CAPA filament production...

Thursday, 20th July 2006 by Forrest Higgs

I went back over the filament production issue again and may have just hit upon a new wrinkle. I looked again at the ASTM standard capillary viscometer that is used to measure the melt index of polymers.

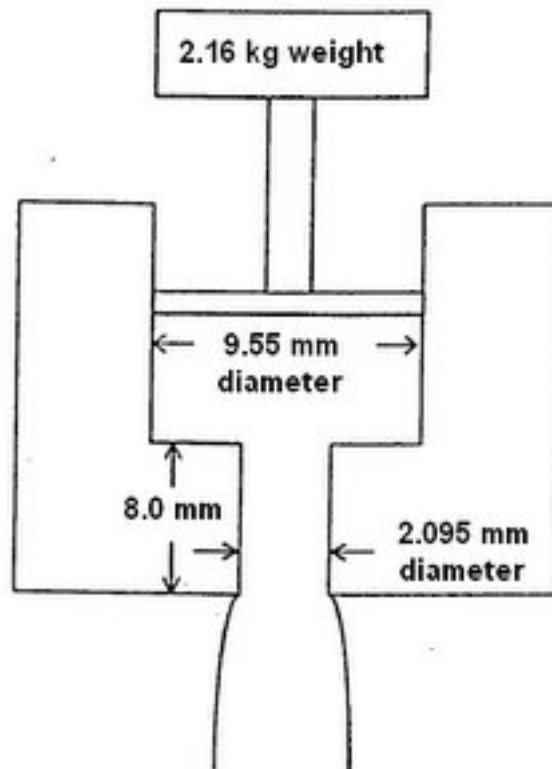

Previously, I had made something like this out of plumbing parts. While my system worked after a fashion there was a problem in fabricating a piston that would force the polymer out of the die. As well, there was a problem in scaling the device up in a way that would let us process a meaningful charge of polymer (~1 kg).

I think that I may have hit on a bit of a breakthrough in that regard by revisiting the diagram of the capillary viscometer and then getting the melt index of CAPA 6800.

http://www.solvaycaprolactones.com/docroot/capro/static_files/attachments/capa_6800.pdf

At 160 degrees Celsius CAPA 6800 caprolactone's melt index is 3 grammes/10 minutes. What that means is that this device, heated to 160 degrees will extrude 18 grammes per hour or 0.4 kg/day of filament which is roughly 2.4-2.5 mm in diameter.

When you think about it that's awfully close to the size filament that we need and the daily production is within shouting distance of what a fully functional Godzilla scale RepRap could use.

Making the die a bit wider so that we could make 3 mm filament would actually make the device work faster, so that's not a problem. As well you could reduce the depth of the die channel which would also speed things up.

So what are the problems?

The big problem is the size of the melt chamber. A chamber diameter of 9.55 mm (3/8ths inch) is too small. The melt chamber is sized to hold no more than 15 cm³ of polymer. If we keep the diameter as is and increase the height of the melt chamber we can keep the force required the same. With such a small diameter, though, the practical limits of this approach are reached very quickly. If we increase the diameter as we must, however, the force applied to the piston in the melt chamber increases as the square of the diameter. The practical limits of that, for a device that we wouldn't mind having around are also reached very quickly.

Lets take a look at that force for a moment. We are applying 2160 grammes (I know the units are ideosyncratic, but bear with me for a moment) of force to 71.6 mm² of piston area. That means that we have about 30 grammes/mm². Since 1 atmosphere of pressure is about 10 grammes/mm² we are applying about 3 atm of pressure to the top of the melt to get that highly desirable flow rate.

A pressure of 3 atmospheres in US units is about 44 psi. Being an American who has spent much of his life in SI only countries I carry alotof conversion figures in my head. Last weekend I took Zach down to the Kragen auto parts shop and snooped around while he bought several things that he needed to repair his VW Kombi. I was quite taken with a US\$199 generator set rated at 1200 watts continuous. I also looked at a similarly cheap shop compressor and noted that it operated at two pressure ranges, viz, 45 psi and 90 psi, or 3 and 6 atmospheres.

Click!

We're using plumbing parts, right? A pressure of 3-6 atmospheres for plumbing parts should be a walk in the park.

Let's look again at my little filament experiment from a few weeks back.



What's to stop us from screwing another brass cap on top of this assembly and tapping a very standard compressor connector to it and then hooking it up to a standard shop compressor to provide the pressure that I was applying manually with great difficulty.

The short answer is... nothing.

Once you fire up the extruder barrel enough to plug the bottom of the barrel you can apply pressure. A 200 mm length of 100 mm pipe would easily hold 1 kg of CAPA 6800 granules.

About the only objection is that a standard shop compressor is massive overkill. We require very little actual air volume, only the pressure.

With that in mind I went shopping and quickly found this...



This is a tiny compressor that you plug into your car's cigarette lighter. It costs US\$8.24 and very conveniently runs on 12 volt power.

<http://www.nationalonlinesales.com/index.asp?PageAction=VIEWPROD&ProdID=193>

It should provide more than enough air volume to do the job.

Heating the barrel is probably more than we can reasonably expect from a 12 v system, though. Happily, our friends at IMS have a solution.



Their mica insulated band barrel heaters are widely used in the plastics extrusion industry. IMS will sell a 100 mm diameter x 100 high unit rated at 750 watts, far more than you need, to you for about US\$30.

This should be fun. :-D

Frankenboard meets the Frankenmotor...

Saturday, 22nd July 2006 by Forrest Higgs

I got the rest of the wiring for the Frankenboard checked out. A loose soldered joint in the H-bridge cost me another PIC, but otherwise there were no problems.

The G4 motor tested out on the parallel wired 4-5 amp board without any problems. Speed, direction and the lot.

I ran it for some time at a PWM setting of 226 (0 -255). A few hints for people wanting to use the L298N chip. It's a great chip but you have to treat it with respect

- don't touch the chip while it is running or for some time thereafter, especially if you are testing the board after having built it up and have the possibility of a loose electrical joint in the H-bridge. It gets quite hot, even with a heat sink attached.
- ground the sense pins if you want it to work
- pay especial attention to the orientation of the shottky diodes when you install them. I've got what looks like a fair second degree burn on my index finger for getting that one wrong.

I am beginning to see why you'd want to optically isolate the L298N chip from the PIC. If something is not quite right in your build of the board you can wind up with some impressive voltages hitting your PIC. I've lost three figuring that out.

After proving the board on the G4 I shifted it to an unmounted Frankenmotor and then to the mounted Frankenmotor that drives the z-positioning stage (horizontal). I was able to operate the z-stage as is (which means lots of friction) in a translation speed range of 10-30 mm/sec. There didn't seem to be any problems with overheating of either the motor or the H-bridge chip.

The Frankenboard was also tested against the high torque Siemens gearmotor. It is likely that this gearmotor, rather than the Frankenmotor currently installed, will be used to power the y-axis (vertical) on Godzilla. While slow, the Siemens Gearmotor has a very smooth movement and is nearly impossible to stall.

One little added benefit that I discovered is that the magnet that activates the AS5035 shaft encoder chip sticks to the end of the threaded drive rod and centres itself perfectly without glue or any other kind of bother. Every little bit helps. :-)

What we might make with a reprop...

Monday, 24th July 2006 by Forrest Higgs

I'm expanding a post that Alex made to my last blog entry because it gives an idea of what one can get up to with a 3D prototyper. The famed Lockheed "Skunk Works" that produced such aircraft as the U2, the SR-71 Blackbird, the F-117 stealth fighter and a variety of other air and spacecraft whose details have never been made public has now created a new UAV called the "Polecat".



According to the New Scientist...

About 90 per cent of Polecat is made of composite materials with much of that material made by rapid prototyping.

Why? It's cheaper than conventional construction methods for very much the same reasons that we've been talking about...

This use of rapid prototyping is certainly a revolutionary approach to making an aircraft," says Bill Sweetman, aerospace and technology editor of *Jane's International Defence Review*. "The classic way is to set up a production line with very heavy-duty fixed metal tools that hold everything in the right place." That is too expensive an approach for the low production runs that reconnaissance UAVs are likely to need, he says.

The Polecat was recently shown off at the Farnborough Air Show.

I think that we're in very good company here. :-D

RepRappers of the World Unite!

Tuesday, 25th July 2006 by Adrian Bowyer

A number of people who are not members of the core development team have started building their own RepRaps - Welcome to them!

I have set up a blog as part of the RepRap project for any of them who want to record their discoveries, hints, calls for help, pictures of triumphs and so on at <http://reprappers.blogspot.com/>.

If you would like to contribute to that blog just e-mail me at A.Bowyer@bath.ac.uk giving a few details of your RepRap project.

Mk2a RepRap Polymer Extruder Head

Tuesday, 25th July 2006 by Vik Olliver

I've just finished assembling the current generation of polymer extruder heads, which I have taken the extreme liberty of referring to as Mk 2a. I thought a picture might be in order:

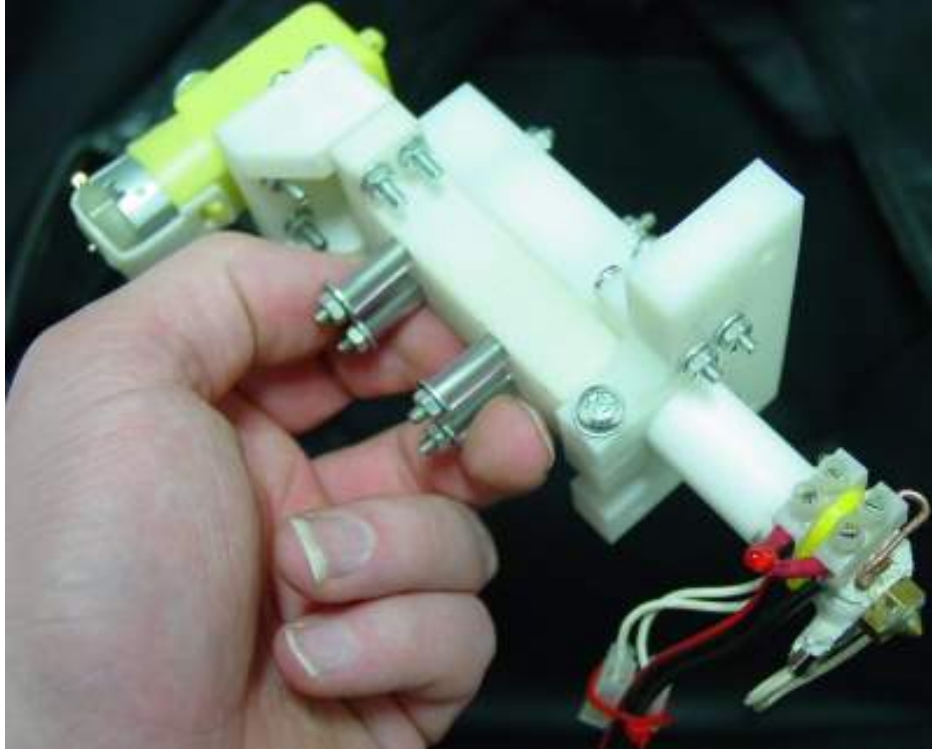

Some of the materials are different; the bits attached to the motor are made from SLS nylon, for example. Also I've used Philips head screws instead of cap screws throughout. There are a few other changes from the original design:

- o The springs have been replaced with silicone tubing.
- o The central channel that guides the filament now has little walls.
- o The PTFE rod is now 16mm diameter.
- o The nozzle is interchangeable.
- o The filament is insulated nichrome, though this isn't working well.
- o The coil is insulated and kept stable with fibreglass/plaster.
- o The thermistor is on a tag, pierced by the barrel.

Does it work? Dunno yet. I have a Mk2a extruder controller board to build first!

Vik :v)

Frankenboard and Frankenmotor with IR

Thermometer...

Wednesday, 26th July 2006 by Forrest Higgs

I finally got the camera back after many adventures and post for your delight a pic of the working PWM Frankenboard and Frankenmotor. I haven't installed the shaft encoder and limits detector at this point.

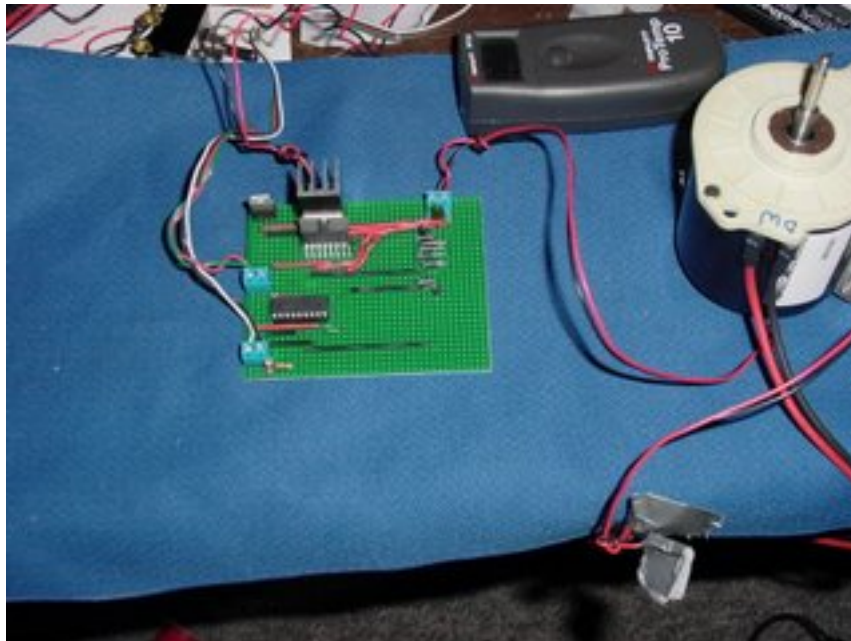

I burned in the board for 20-24 hours before the comms card packed up on Monday night. At the PWM frequency that I'm using the motor will very rarely get out of sync with the pulse train and just stop for no particular reason. That has happened about twice that I've observed. Feedback from the shaft encoder can be used to restart the motor or shut down the PWM signal safely.

That heat sink is really necessary.

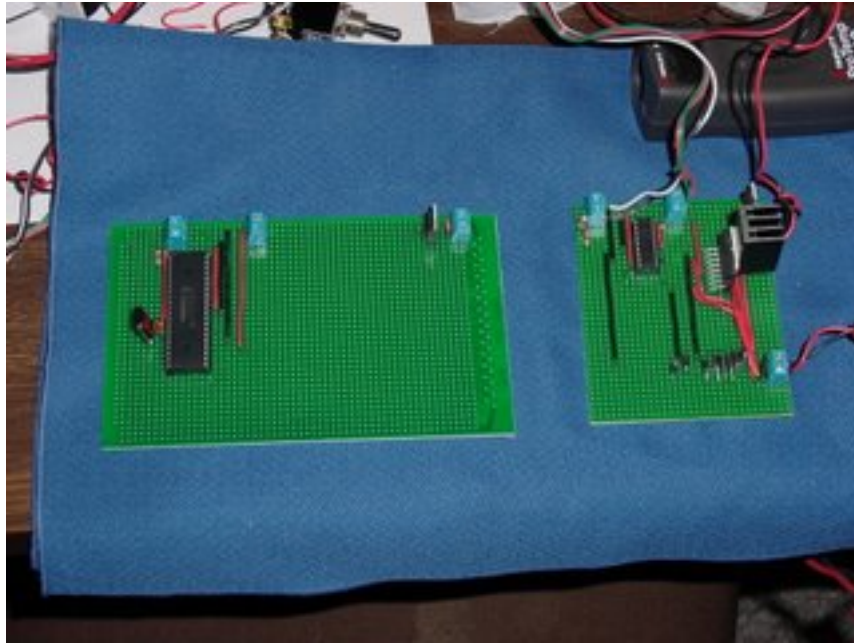

Here's a quick pic of the 16F877A board built out for serial comms. The relative size of the two cpu's is quite astounding. I haven't decided yet whether I want to build this one out as an extruder board or attempt to see if I can drive both the x and z axes (horizontal) with the bigger 16F877A chip.

Sign For a RepRap

Saturday, 29th July 2006 by Vik Olliver

We've had a wee bit of discussion on an idea which we can't really take any further due to lack of all sorts of important stuff like time and resources. But it deserves to be blogged nonetheless. Perhaps someone will even take it to The Reprappers Blogspot, where people who are actually doing some building live :)

The general concept is to use a CNC router to cut sheet acrylic or polyethylene to form the basic essentials of a RepRap prototype for keen hobbyist developers. This is a little controversial, because it isn't a pure-bred RepRap and it isn't a made-from-scratch masterpiece. It sits somewhere in the middle, shuffling its feet uncomfortably. There are two main areas in which this idea has some merit:

1. There is a thriving CNC router community who know a thing or two about designing axes and stuff. They often have the technology and curiosity necessary to want to play with RepRaps.
2. It turns out these things are readily accessible at reasonable prices to all and sundry, including those to whom CNC is one of the Dark Arts. The local signmakers are a secret clan of machine shops.

Signmakers, you see, take vector drawings and use computerised routers to cut shapes out of sheets of acrylic. These sheets can be up to 10mm (3/8") or so thick, though a reasonable thickness for one-pass cutting is more like 6mm. Holes of 3mm and greater can be cut with the general routing bit. Acrylic and polyethylene are reasonably inexpensive, so materials for the thing could be <\$50 for all parts. But...

One of the reasons RepRapping is so appealing is you only pay for what you use. With CNC routing you pay for all the material, and then you pay extra for the "cutting lines" needed to hew your part out. So someone would need to convert the basic "Da Witch" parts, or their functional equivalents thereof (we've a few sensible changes in mind already), to a 2D vector image (AI, DXF, SVG etc.) using a minimal amount of cutting. Instead of being full of lightening holes to save plastic, for example, the gears would be solid. Other designs are undoubtedly better, but we do know Da Witch actually works.

Given this plan, anyone in a conveniently civilized spot with sufficient cash can then stroll into a signmakers, say "print me one of these on so-many millimetre/inch acrylic, my good fellow, and be snappy about it," and come out with a funny look and snap-off sheet of flat-pack RepRap bits.

It's a thought.

Vik :v)

Repstraperous

Sunday, 30th July 2006 by Simon McAuliffe

I guess I can no longer call my contraption RepStrap because that word has taken a life of its own. So I'm renaming it after a character in a childrens book I remember reading when I was young, which was "Repstraperous".

I've posted some pics and progress on <http://repstrap.blogspot.com/>

I'm mentioning it here too, because I know nobody actually looks at that blog :)

Amusingly, it was last July (2005) that I soldered together the first bits of copper pipe. I was somewhat sidetracked by other parts of the project, but I think it's time to get something going for myself too. It's hard to believe a year has already passed. A year is long enough...

But today it finally does something. No Z axis yet, so the next thing to do is build a L298N driver for that.

Comms working again...

Sunday, 30th July 2006 by Forrest Higgs

I got my parts consignment at noon today and after discovering that the blown 100 uF capacitor wasn't the only problem that the comms card had I decided to build a new one. The new one is at the top of the pic and the old one is under it.

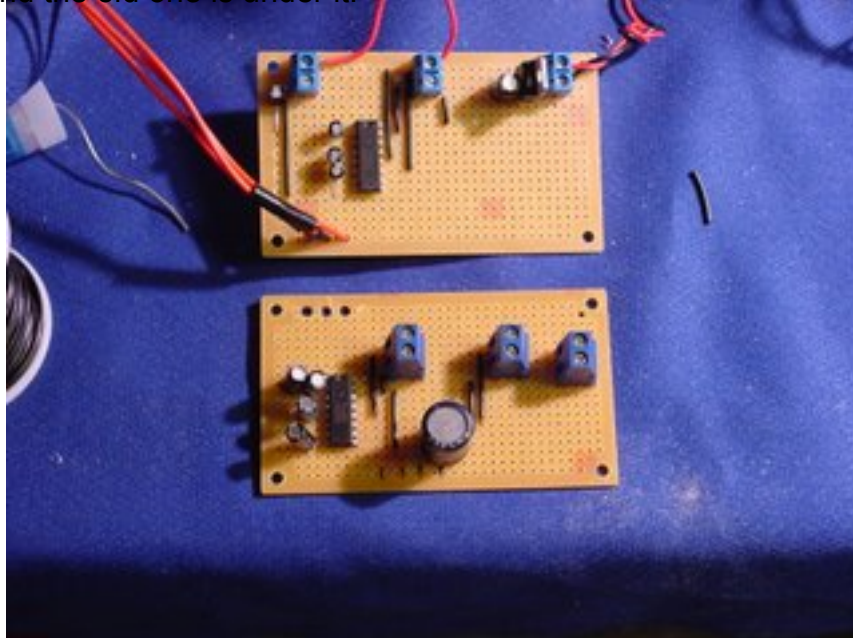

As you can see the new card is considerably neater in layout than the old one. Probably the biggest difference was that Randy at Glitchbuster stocks some really short dinky little electrolytic capacitors that take up a lot less room on the board and don't get in the way nearly so much.

I've also stopped trying to use the 5.35v power off of my power supply and have taken to just using regulators to cut 12v down to 5v exactly. I've made that and the serial comms terminals placement on all my boards the same, viz, along the top edge with the 12v supply on the right hand side of the board and the serials comm terminals on the left.

Anyway, I used Simon's diagnostics when I was assembling the board. I then ran a standard serial loop test on it and it fired right up and worked without so much as a hiccup. :-)

I hooked up the Frankenboard and fired up the Frankenmotor with no problems, too. :-D

First tries at slicing and dicing...

Monday, 31st July 2006 by Forrest Higgs

I woke up this morning with a dread of spending the day doing soldering and PIC programming so I veered off in another direction entirely. I've admired Adrian's STL conversion software and wondered if I could do something similar, if possibly not quite so photogenic. As a first task I set out to slice up an STL file. I cranked out something quickly in Aol.

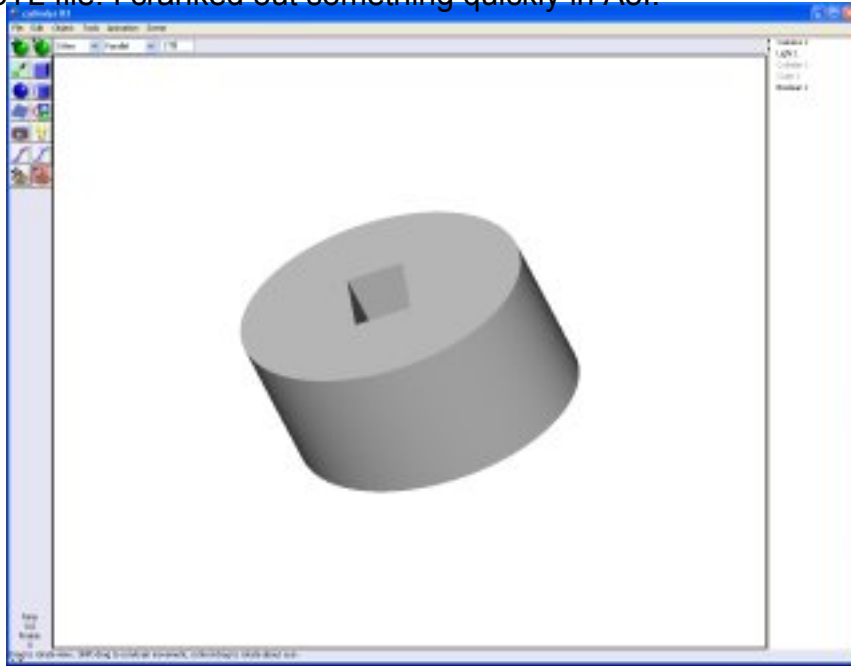

Afterwards, I exported the "design" as an STL file. Here you can see what the shaded solid in Aol looks like as a wire frame representation of its STL file.

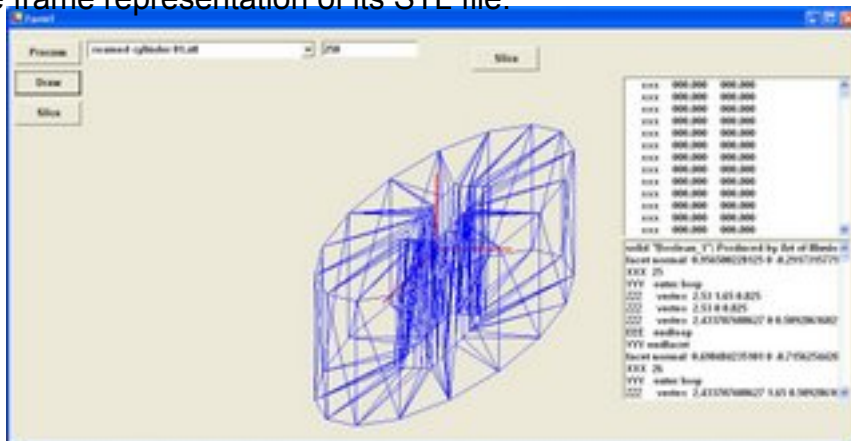

Then you can see what happens when you make multiple passes through the STL representation of the solid form with a cutting plane.

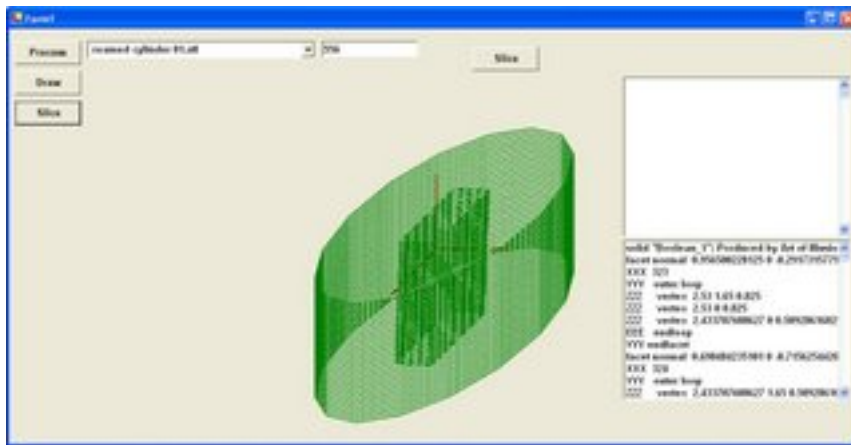

From there we start mapping paths for the Mk II to extrude the solid.

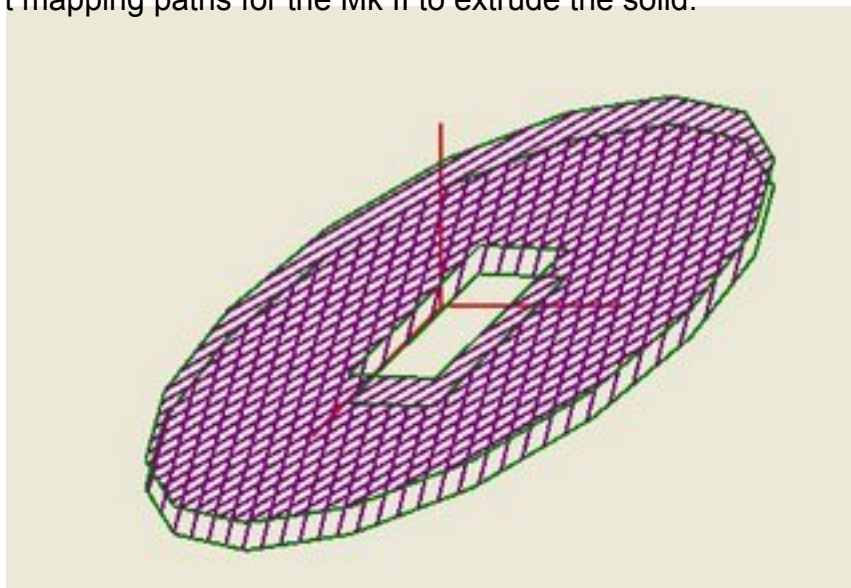

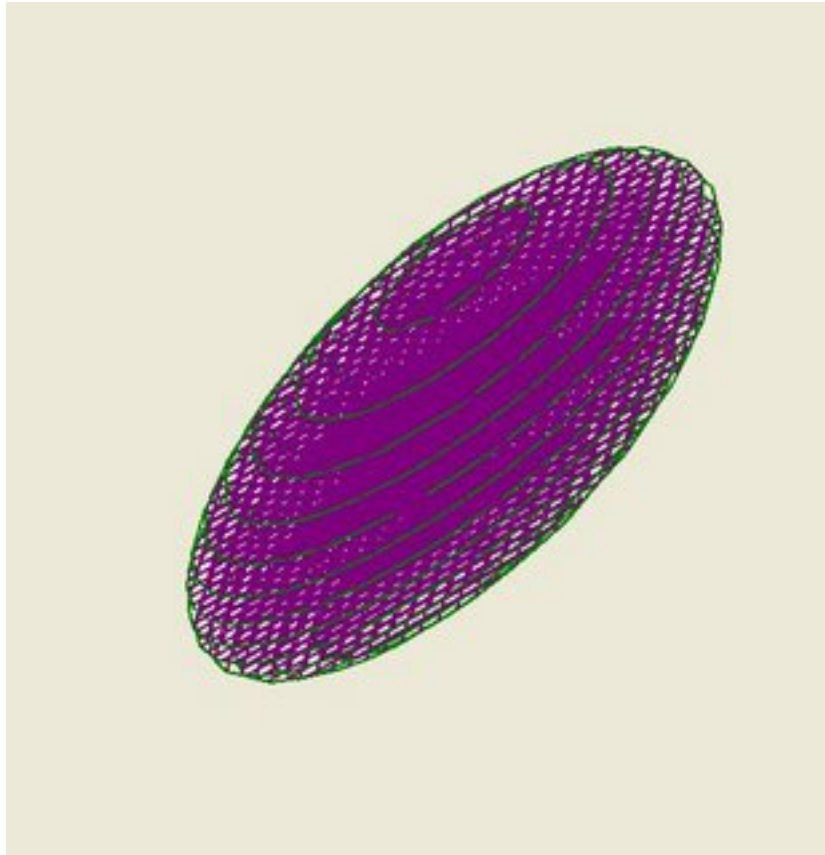

The next step will be to map the boundary paths for the layers.

The code looks fairly robust so far. Mind, I haven't attempt to correct for pixel geometry yet.

More slicing and dicing...

Thursday, 3rd August 2006 by Forrest Higgs

I got the perimeter line segments into inner and outer loops and consolidated line segment fragments lying on the same line (an artifact of using STL files). Now I've begun creating the inset paths for the Mk II to follow to make the outer perimeter of the object.

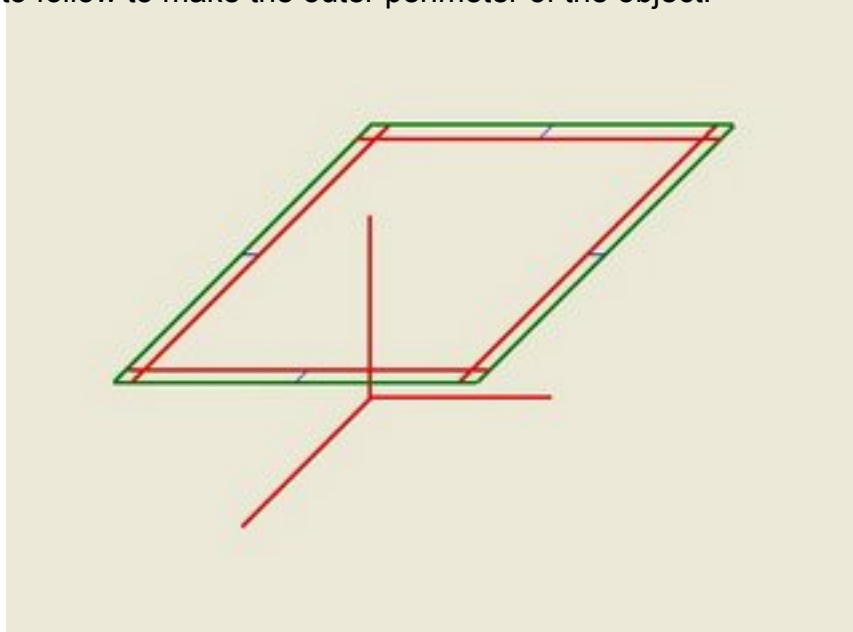

You can see the overlap of the inset perimeter lines. I have to clip off those excesses.

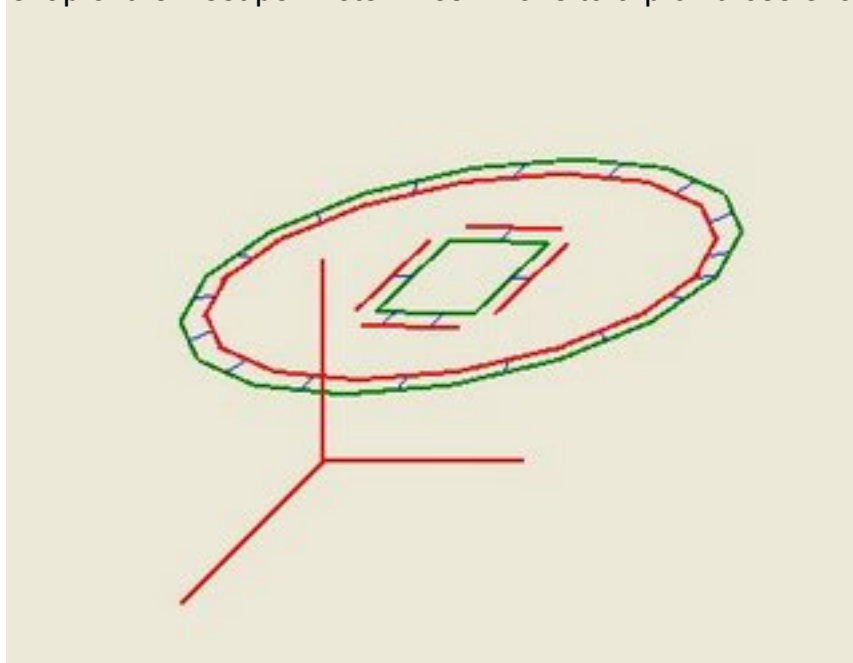

Similarly, here you can see that the perimeter of an inner loop, in this case a square hole in an elliptical cylinder don't quite reach and will have to be extended.

After that trimming and adding I will have to create yet another inset set of perimeter loops which will reflect the inside boundary of the perimeter extrusion put down by the Mk II. That will server as an outer boundary perimeter for doing the cross-hatch paths for the Mk II to fill the layer once the outer perimeter extrusion has been put down. There will be a little more trickiness with that as well, I expect.

I'm getting there, though. :-)

Time to try another approach...

Saturday, 5th August 2006 by Forrest Higgs

That little glitch in the slicing and dicing software turned out to be a very big glitch, a conceptual glitch, in fact. Turns out that the insetting method that I was using to create the perimeter path for the Mk II has a real hassle. You can see it here.

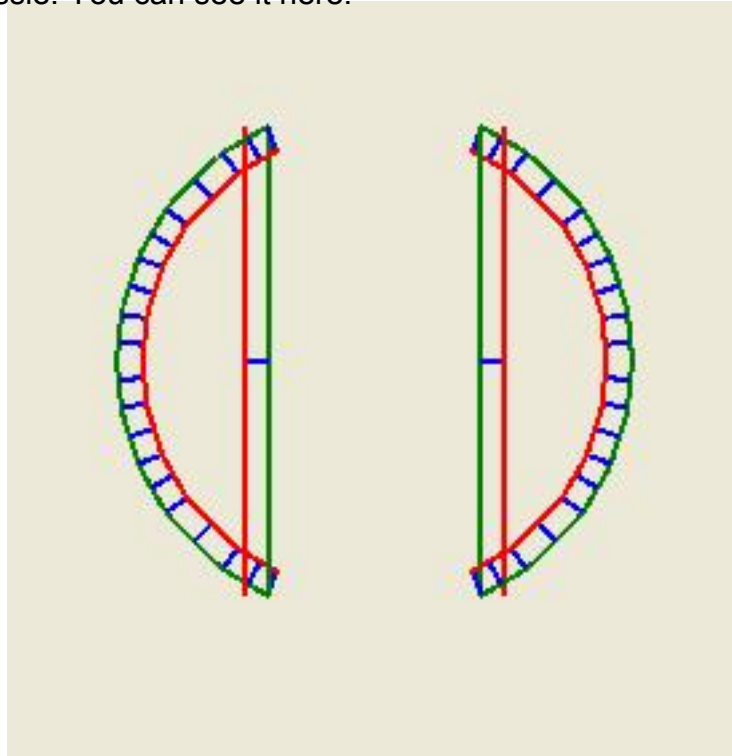

The green line segments represent a slice across the bead and the red lines represents the attempt to inset them. It turns out that if you have a straight line meeting a curved line at an acute angle you can get some real problems with overlaps where the overlap can mean that several curved line segments can protrude beyond your straight line. That makes my little clip or extend routine more than a bit problematic.

Right off hand I can't see a way to fix that which doesn't involve me checking every inset line to see if it intersects with another inset line. That's just about an n^2 calculation problem which is a terrible thing to have in your code.

I'm half-tempted to go on and steal Adrian's grid approach and salvage the rest of my routines to work with that. I'm going to think about this for a few more hours before I do that, though. Maybe I'll think of something sneaky. :-)

Quick and dirty support structures...

Saturday, 5th August 2006 by Forrest Higgs

I was gritting my teeth and preparing to write a lot of coding to build support structures around objects to be fabricated. That seemed like it could be as big a job as actually writing the extrusion control programme and I wasn't looking forward to doing it.

Then I think it was yvan roy who said something about using Pov-Ray to do the job which made me remember something that I thought about a long time ago, that is, that it would be neat to leverage the boolean solids operator in Aol to do the slicing and dicing. That would have entailed a major rewrite of Aol, though, a prospect that nobody on the team was excited about doing, much less maintaining after the fact.

Yvan's comment twiggged me to thinking about that again and I realised that we ought to be designing the support structure for objects in Aol at the same time we design the object. That doesn't require any rewriting at all.

Suppose, for example, you designed a bead like this and it needed to be oriented like this when you were rewrapping it.



All you'd have to do is envelop it and the cylindrical void in the bead with a rectangular solid like this...

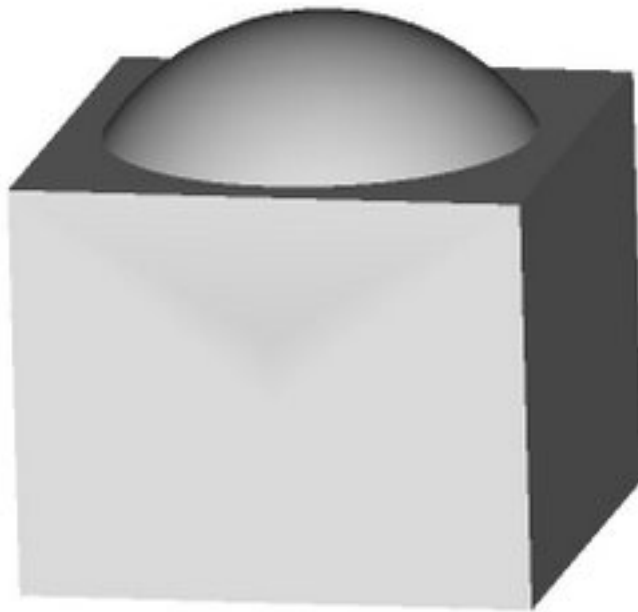

...and then do a boolean operation on the two to remove the bits of the rectangular solid that the bead occupied like this.

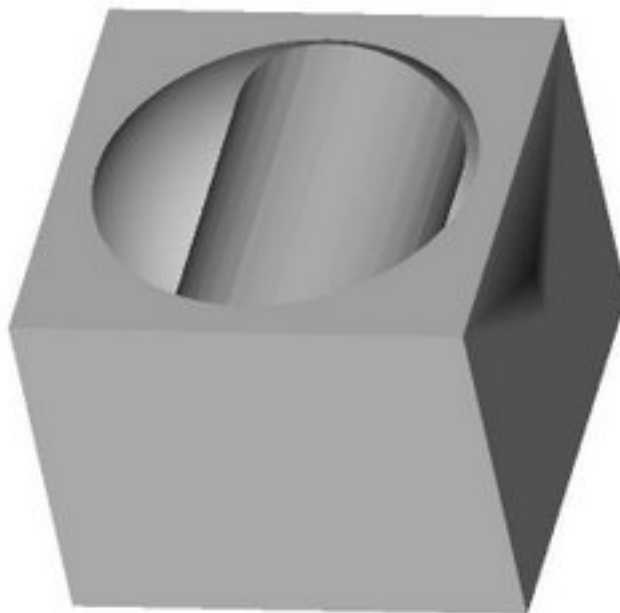

This is a snap to do in Aol.

Then you use your handy dandy slicing and dicing software to slice and compute extrusion paths for the support structure...



...and then the bead...



{I still have a little code glitch with how the inner perimeters are drawn but you can see how it works anyway.}

...then tag the slice files for the support structure as requiring the polyfil, or whatever, extrusion head and the bead as requiring the CAPA extrusion head.

Merging the two files into one which has the support part and the object part for each layer of the extrusion project should be child's play.

Mind, this may have been something that has already been thought of and Adrian may have had something of the sort in mind all along, but, if it hasn't and/or if he didn't there it is. :-)

A good start at slicing and dicing...

Saturday, 5th August 2006 by Forrest Higgs

The VB.NET programme now does slicing, dicing and creating paths for the Mk II extruder to follow.

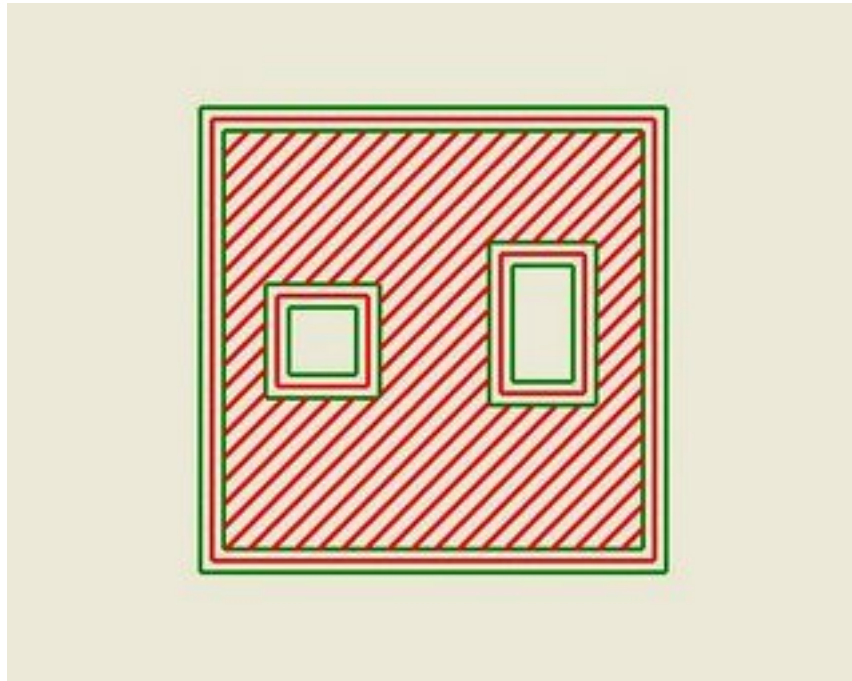

Here is a slice from a rectangle with two rectangular holes in it. The red lines represent the paths for the Mk II extruder.

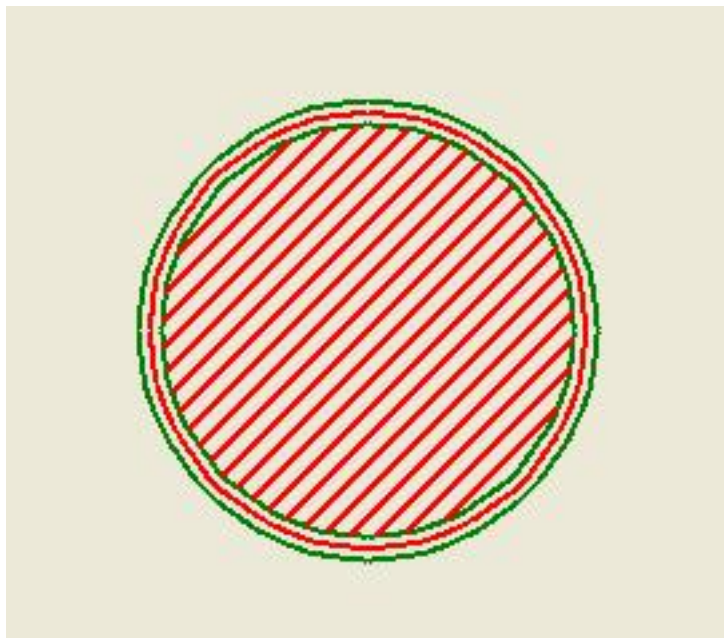

Similarly, here is a slice across a sphere for comparison. The green lines represent the outer boundaries of the perimeter extrusions. I've got to plowshare the infill paths to minimise the time the positioning stages require to do the extrusion.

The code at this point isn't very sophisticated, but it is a starting point and appears to be robust for the purposes at hand.

Now I have to decide whether I want to do something else for a change or tackle the problem of doing support structures. I'm thinking that there is a sneaky way of skinning that particular cat. :-)

First try at grids...

Sunday, 6th August 2006 by Forrest Higgs

Laying out the grids and finding out what part of the grid lay inside the STL files was no problem. I used a quasi-boolean approach with a little smoothing added to find the perimeter boundaries.

The light blue grid nodes represent diagonals from the points that test outside of the STL boundaries.

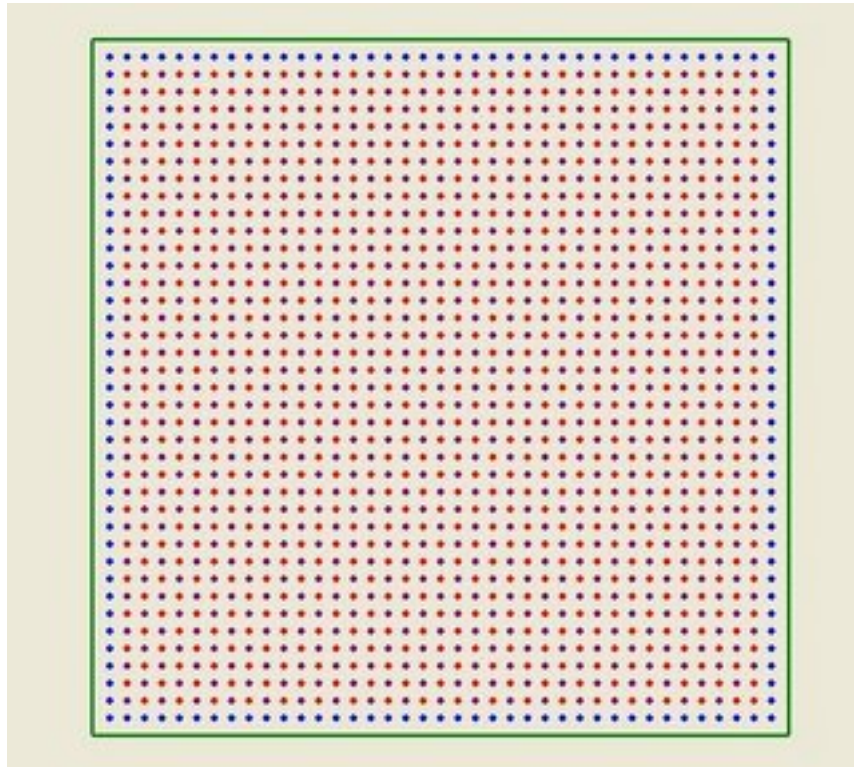

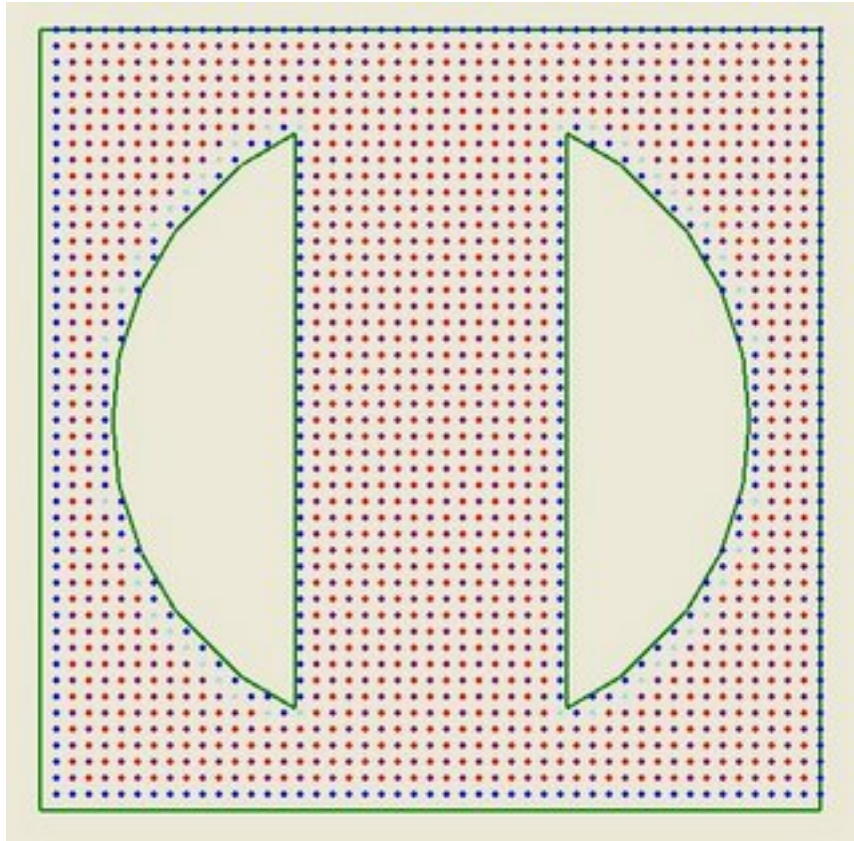

Here you can see the infil diagonals set in purple.

Grids rock!

Tuesday, 8th August 2006 by Forrest Higgs

Finally got my head around how to solve the border problem. Grids rock!

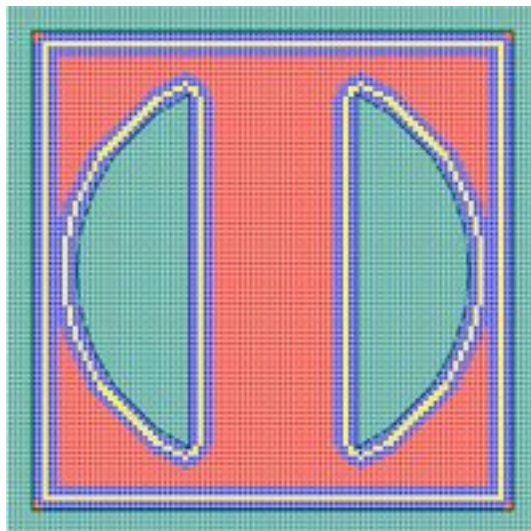

Not only do they track the perimeters properly, but they also show you the path for the centre of the MK II extruder head, won't let you overlap and shows you the corners and blind pockets that the Mk II isn't going to be able to get into.

In this pic the background is cyan, the perimeter is blue with the extruder path done in yellow. The red bits comprise the rest of the slice of the object. I haven't done an infill routine yet.

You can see how the Mk II can't quite get into the corners of the slice.

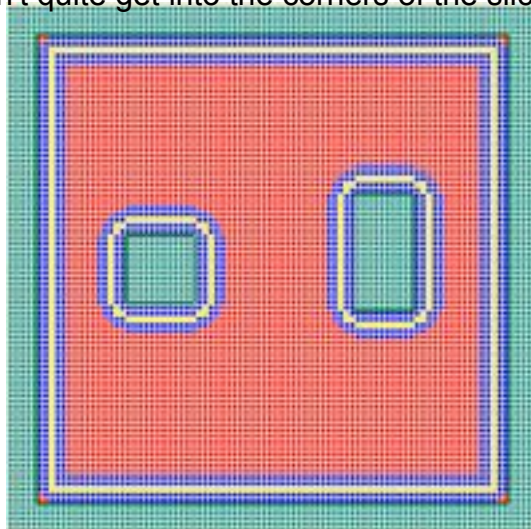

Here is a slice of a rectangular box with two holes in it. Looks pretty good for a start. :-D

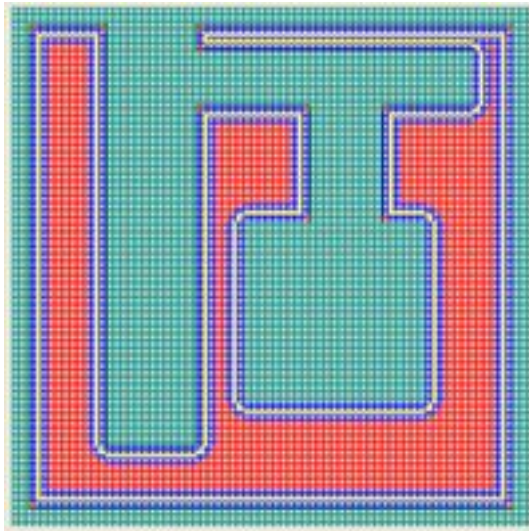

Here is a really, really non-convex slice especially for Adrian. :-D

After looking at Adrian's non-convex polygon, which took a long time to do, I felt sufficiently confident in the approach to migrate some more of the coding from the old slice and dice programme that I wrote a few days ago into the grid. This improved the execution speed of the routine by about 1.5-2 magnitudes

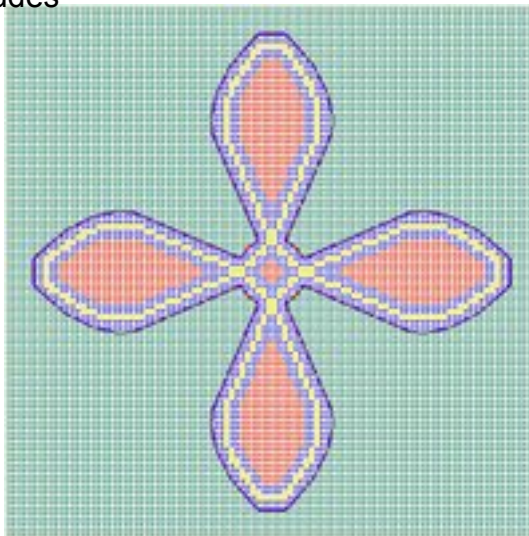

. There are a few other tricks that I can use if need be to kick that speed up another 1.5-2 magnitudes. I'm not going to do it unless execution speed really gets to be an issue again. Because PC's always get lots faster if you wait about 18 months I tend to value code reliability and simplicity a lot more than I do efficiency.

Finally, here is a perimeter trace for a 4-toothed involute profile gear. For this kind of shape I am beginning to wonder if our one-size-fits-all notion of using diagonal, 90 degree offset infills is really a good idea for all the sorts of things we'd like to make. If you look at the inner spot of infill required for this gear it would seem that a quick doubling of the perimeter depth would be more appropriate, ditto with the infills in the teeth. This requires some more thought, I suspect.

I am particularly excited about the prospect for leveraging this method with some heuristics that give the user some useful graphics feedback about whether the RepRap machine can actually make the part the user is designing. I suspect this is going to be a very big issue for the sorts of RepRap users who are using their machines to create new devices rather than simply making salad bowls and napkin rings.

Serious tests...

Wednesday, 9th August 2006 by Forrest Higgs

I went ahead and ramped up the analysis speed of the routine another two magnitudes so that I could try to slice and trace perimeters for some serious STL files in reasonable, not geological, time frames. I used the involute profile gear script for Aol to generate a 13-toothed gear with a pitch diameter of about 20 mm. The STL file contained 30,486 triangles. I set the grid at 0.1 mm and let it rip. The perimeter is about 0.4 mm across. I probably should make it a bit bigger, but you get the idea.

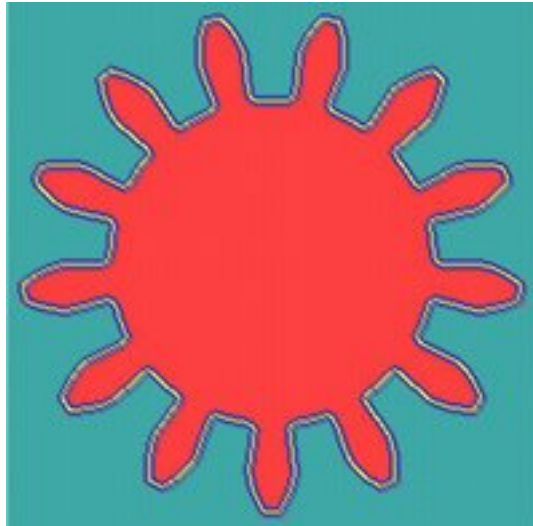

Not bad, huh? :-D It looks a little rough till you realise that this is really quite a small gear, only about 48 mm in diameter... just under two inches.

Next I'm going to do top down slicing and calculate the support structures. Using Adrian's approach it should be a snap. :-)

Then I'll be revisiting the infill question. :-s

Infilling...

Friday, 11th August 2006 by Forrest Higgs

After thinking about all of the drama involved in a cross-hatching scheme I got to wondering what would happen if I just used the perimeter tracing routine over and over to do the infill. Here is what happened.

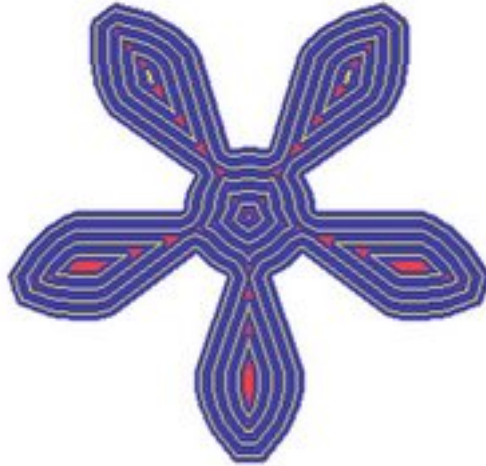

I first tried the gears since I thought that they would be the most challenging.

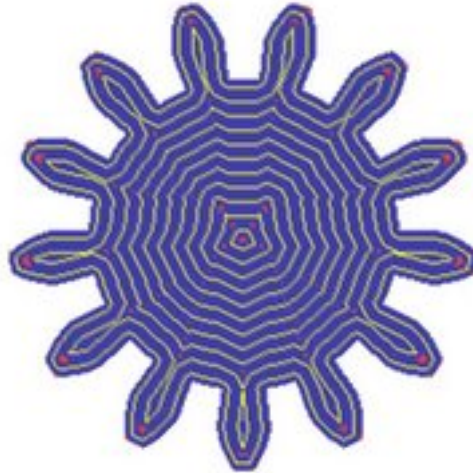

Remarkably, there was very little in the way of voids left in the extrusions.

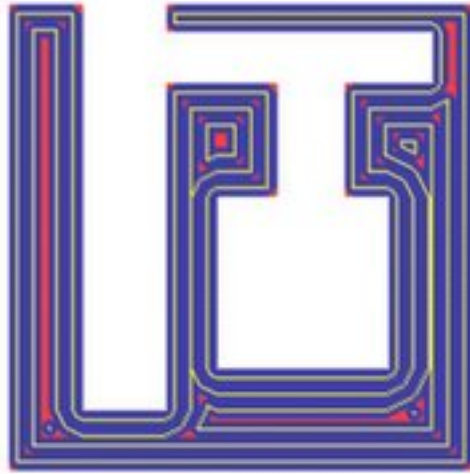

The first serious problem I had with voids occurred with the non-convex example that I did for Adrian.

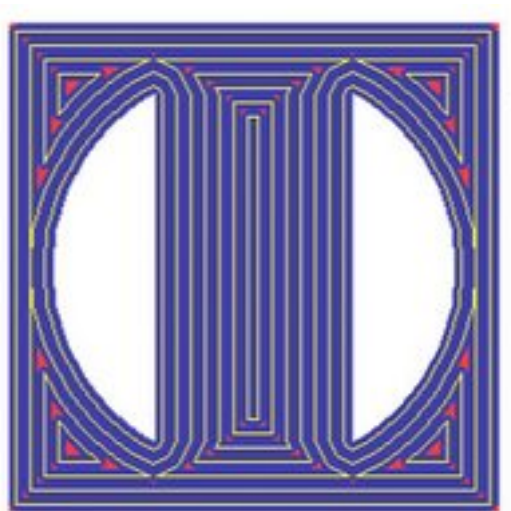

This last slice from the bead support structure I just threw in because I liked the pattern it made. I was an architect for a long time, so sue me. :-P

I am wondering now if it would be possible to fill the more egregious voids by simply making passes over them with the Mk II with the extrusion rate throttled down for the translation speed and sort of squeeze polymer into the voids using the already extruded walls as molds.

Diagonal Infilling...

Saturday, 12th August 2006 by Forrest Higgs

After Adrian's warning about the dangers of overlaying the same pattern slice after slice, I went back and developed an alternating diagonal infill routine. One of the issues that I had to confront was what to do when the perimeter routine couldn't deal with a feature of a slice that was narrower than a perimeter extrusion track. That required a little routine that determined which parts of the slice were outside of the perimeter after the perimeter had been developed.

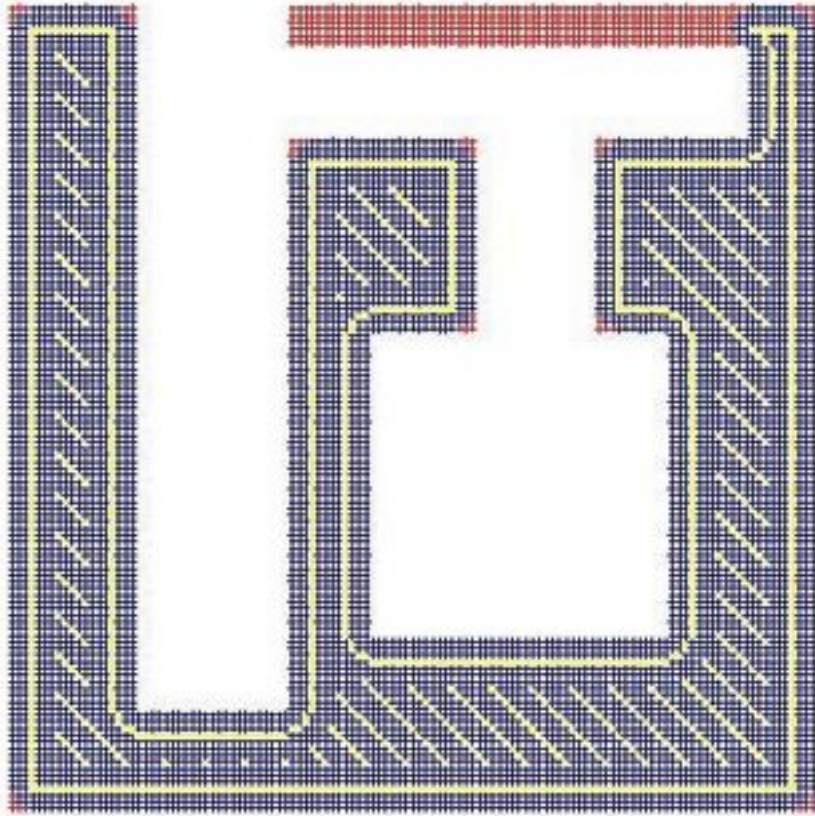

You can see the results here. That red bit at the top is a feature that is narrower than a single trace of the Mk II. You can also see some red bits on the corners that represent parts of the slice that are too fine for the Mk II extrusion to reach.

Yesterday, Adrian suggested that I should be a bit more forthcoming with my developments both in documenting them and making them available while they are in the development phase. His point is very well taken in that I consider what I do almost perpetually "in development".

On the other hand, I am well aware of the fact that I am a very untidy person and am hesitant to let that untidiness flood into places like RepRap's subversion system. I'm going to try something that might be the best of both worlds. To that end I've opened up a directory on my own server...

-
<http://www.sanma12.com/reprap>

...as a repository for my extensive, messy, non-standard "developments", such as they are. For those of you working in a Wintel, Visual Studio.NET development environment my current code can be acquired at...

[http://www.sanma12.com/reprap/software/VB.NET PC-Side Control System/Grid 09 upload 120806.zip](http://www.sanma12.com/reprap/software/VB.NET%20PC-Side%20Control%20System/Grid%2009%20upload%20120806.zip)

For the more orthodox RepRappers who are using Linux and Java, still feel free to grab my code and give it a look if you suspect that there may be something useful to what you want to do. VB.NET isn't very hard to read if you know where to look in the half-dozen files that a Visual Studio project generates.

In this case all of the actual BASIC code can be found inForm1.vb. Just open that file up in some sort of text editor and search for#End Region. The actual code follows that statement which is at the end of a bunch of statements that tell Visual Studio how to set up the form with buttons, labels and the like. The code proceeds from#End Regionto the end of the file in plain ASCII text.

Going a bit further, the routine has three procedures that are taken in the following order...

Private Sub Button1_Click(ByVal sender As System.Object, ByVal e As System.EventArgs)
Handles Button1.Click

- reads in the STL file
- generates the slice

Private Sub Button8_Click(ByVal sender As System.Object, ByVal e As System.EventArgs)
Handles Button8.Click

- sets up the grid and determines what part of the grid lies within the grid
- develops the perimeter extrusion track
- determines what part of the slice lies within the perimeter

Private Sub Button2_Click(ByVal sender As System.Object, ByVal e As System.EventArgs)
Handles Button2.Click

- does the infill

Those three buttons call several other little utility routines which can also be easily found in theForm1.vbfile using your standard text search facility.

When I actually get something that is more or less complete, I'm talking about subsystems, you can be sure that it will be documented and placed in the Wiki and/or the subversion files.

Next gen RepRap in progress

Saturday, 12th August 2006 by Vik Olliver

Da Witch has now given way to a new model, currently without designation, that has been constructed in a frame of thick-walled copper piping. I've used a mixture of copper saddles and hose clamps, but it could be done with hose clamps throughout:



Image not found.

The frame is bedded in with Polymorph to two bits of 3x2 , currently held to the bench with G-clamps. The head and X-axis are held into the copper frame by hand-moulded Polymorph and hose clamps. Ordinary cable clips hold the wiring into place.

This is the model likely to be exhibited at Paraflows '06 in Vienna, travel arrangements permitting.

Vik :v)

Hatching a thicker plot

Sunday, 13th August 2006 by Adrian Bowyer

Forrest has been working on bitmap-based infill algorithms for depositing the build material in layers; these have the advantage of being very robust, but they are a bit memory hungry.

Meanwhile, I have been improving the infill routines for the Java CSG representation.

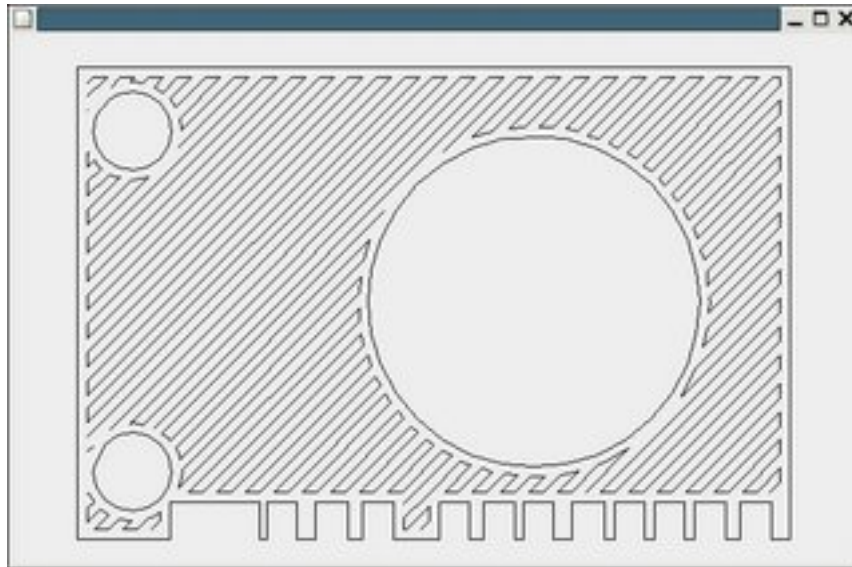

Above is a test piece. The outer rectangle and the circles are the delineation of the shape that the machine lays down first. It then follows the hatch lines to infill between those boundaries. The hatch needs to be offset by the stream width inside the boundary (and the outer boundary needs to be offset inwards by half that width from the true boundary). The hatch follows a series of "pen down" movements that are all connected to minimise the amount of "pen up" movement.

Well. I say minimise. It's actually a fast heuristic. A true minimisation would be a travelling-salesman solution, which would probably be a bit slower...

Rack and Pinion...

Sunday, 13th August 2006 by Forrest Higgs

I converted Kiplinger's maths to code and tested them. His pinion gear routine seems to be nothing more than an involute profile gear like we already have. Mind, the Swedish approach seems more robust than Kiplinger's. His routine for generating rack gear strips is trivial and appears to be very robust. I've got that going in a VB.NET test programme and will sort out the problems, such as they are, in it before shifting it over to a Java script that will work in Art of Illusion. Most of the "problems" are making sure that the routine generates a proper loop of line segments and resolving a terms difference between the input data for the Swedish involute profile gear programme and the rack programme. I don't think that is going to be any big deal.

Here is a sample rack I generated with the VB.NET code prototype routine.



It is a 14.5 degree pitch angle rack.



Just for variety here is a 20 degree angle rack. Pitch angles of 14.5 and 20 degrees are pretty much the industry standard for this kind of gear technology.

Second prototype gets some guts

Sunday, 13th August 2006 by Vik Olliver

I've got the electronics mounted up and the motors installed. This is much more of a working environment than a prototyping environment, so all the boards have been hived off into a little plastic box. It has a lid, and maybe one day that'll fit on. Meanwhiles, I fear the spaghetti will proliferate a bit. Thought you might want to see this morning's progress:

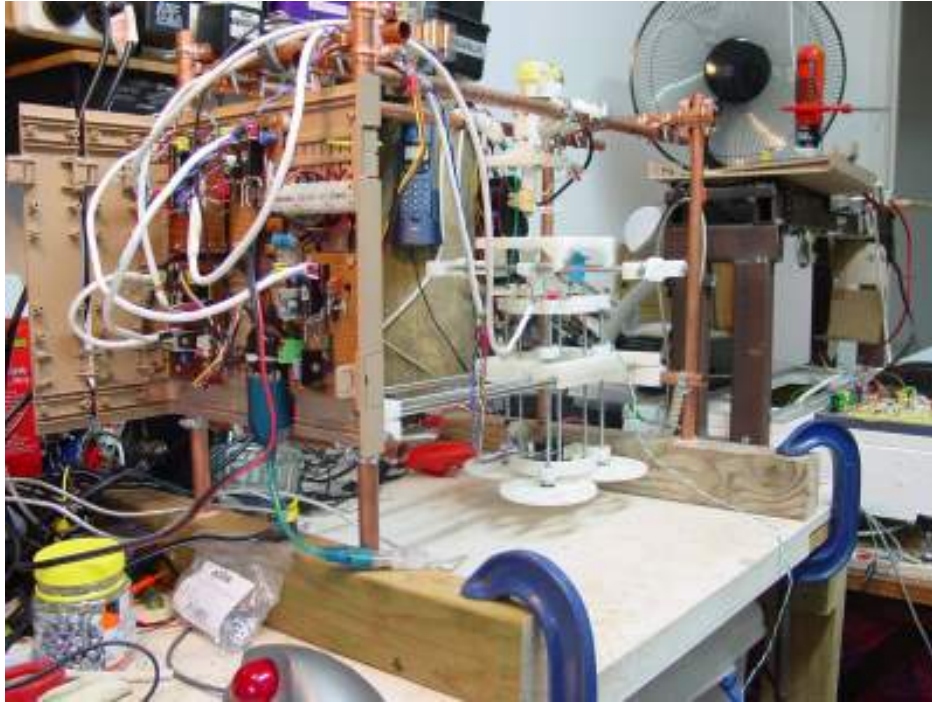

Yes, I know we planned to mount the little boards on the parts that they control. However, I need equipment that will survive the airline baggage handling system so something a little more robust is needed.

There have been questions about how the Polymorph and No. 8 wire are used to hold on the Mk 2a head, so here's a detail view with the background shaded out to clarify things. The long machine screws have a nut on them underneath the Polymorph, which is in turn cored with single strands of No. 8 galvanised fencing wire:

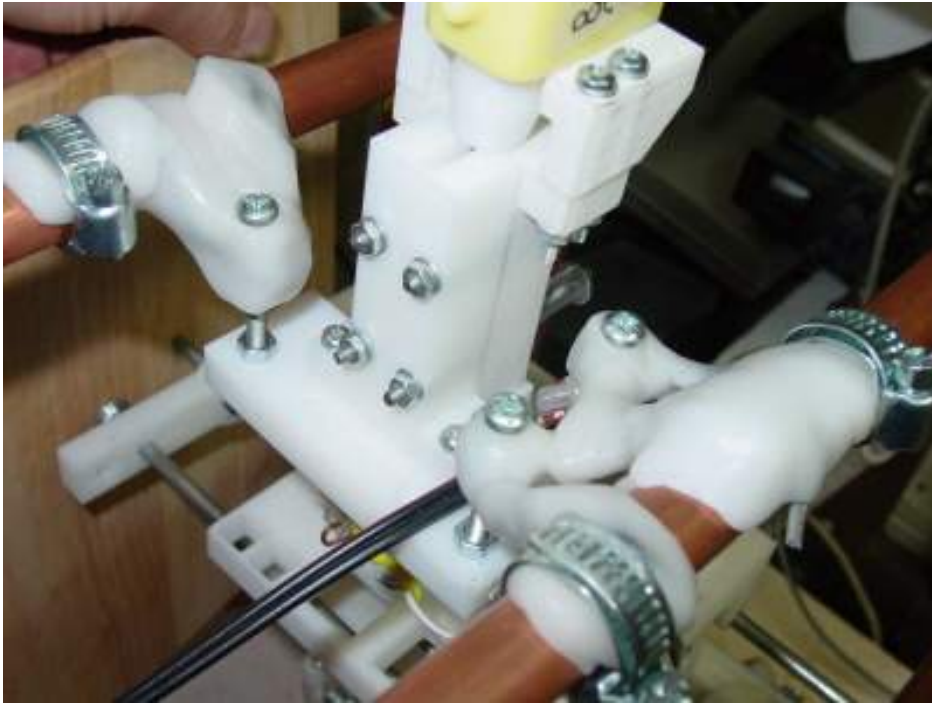

A wire end can be seen sticking out lower right. The saddles provide a handy anchor for hose clamps, and are contoured with a lip to help keep the clamp in place. The black heater power cable snakes through the view.

Vik :v)

Under pressure

Monday, 14th August 2006 by Adrian Bowyer

On Saturday, July 08, 2006 I blogged a start at a design for a peristaltic pump for driving pastes and the like through RepRap deposition heads. One of the adjuncts that this needs is a pressure sensor so the microcontroller can tell when to turn the pump on and off.

Here's a thing:



The little grey square on the left is a quantum tunnelling compound pill, which you can find out more about [here](#), and buy [here](#) (product id: N18BU). But all you really need to know is that its resistance drops when you squash it, and it costs £0.50.

If you place it on some stripboard as above, then put a soft silicone tube over it, then clamp them together you get this arrangement:



The tube is blocked at the left, and the hypo will (in a moment) apply pressure. As you screw the clamp jaws together the resistance goes down - in the picture it's 3.36K.

Now depress the plunger:



The resistance drops gratifyingly smoothly to 590 ohms. Better yet, if you pull on the plunger to create a partial vacuum, the resistance rises above 3.36 K...

It should be very simple to design a little RP screw clamp to hold a small piece of stripboard, the QTC pill, and the soft tube. It might be better to use gold flash on the stripboard contacts, to avoid oxide contamination problems over time. The device could be placed in any pressure line, or attached to a blind tube as above.

Rethinking everything...

Monday, 14th August 2006 by Forrest Higgs

Posts by Sebastien and Simon got me to thinking this morning about RepRap. Sebastian's post led me to recalculate a number I did way back last November and Simon's post made me mad, something I've always found to be a good spur to creative thought. Thanks go to you both. :-)

Sebastien's post was to Vik asking him what the extrusion rate of Da Witch was. Vik guessed at 1 cc/min. I responded doing an envelope calculation which indicated that Vik's calculation was just short of a magnitude off. From the message...

Figuring a 0.8 mm extrusion thread and running at the 4 mm/sec that Mk II was designed for you're getting about $2 \text{ mm}^2/\text{sec}$. or 7.24 cc/hr which gives you a modest, but not unreasonable 5.2 kg/month on a constant duty cycle.

Way back last November I made a calculation of extrusion rates when Adrian first published the Mk II extruder. The number I came up with then was 2.83 cc/hr or roughly 2 kg of polymer/month if operated full-time.

It was always obvious to me that 2 kg/month of polymer extrusion for 24x7 operation was just not practical. This morning I realised, however, that my calculation did not allow for the non-Newtonian swelling of the extruded polymer thread. I was figuring that the thread that came out of the Mk II was the same diameter as the orifice. WRONG! Vik has seen that a 0.5 mm orifice yields a 0.8 mm polymer thread.

Now extruding 5.2 kg/month of polymer is a whole different ball game.

That got me to thinking about Godzilla, which I have targeted 20-40 mm/sec extrusion rates. I've learned a lot designing and building Godzilla and at this point I am sure that I can get it to work, probably at about 20 mm/sec. That would extrude something like 26 kg of polymer a month.

There are some practical problems with Godzilla, though.

It's big. It's got a 700x700x350 mm work volume. It's footprint is about 1.5 square meters. It's also loud. Frankenmotors don't scream, but they are full-throated. Two of them running at once will make about as much noise as an electric blender. If you were married you couldn't keep Godzilla in the house with your wife unless she was as committed to 3D prototyping as you are. That's probably an unreasonable filter for guys wanting to marry to put on potential mates. It just wouldn't work. I'm crazy, live by myself, divorced and have a bit of hearing loss from my misspent youth, so Godzilla doesn't bother me. Most people would be bothered, though. As a practical matter Godzilla would have to live in somebody's workshop and it wouldn't be a machine that you'd want to leave

running overnight or over the weekend. As a practical matter you're not going to be able to run it for more than about 8 hours/day.

That means that you're only going to be extruding about 8.7 kg of CAPA a month with it, that's only 2/3rd's more than Vik's machine. Now it can make lots bigger things than Da Witch, but realistically, how often are you likely to be making huge things with your RepRap?

That's a bitter pill for me, but there it is all the same.

Now let's get to Simon's message that made me mad, but in a creative way. He indicated that servos aren't on for now, that it has to be steppers. Well, I've probably got more hours working with turning brushed DC motors into servos than anybody on the team and I couldn't disagree more. Now Frankenmotors need some work and a lot of thinking to be used properly. The little yellow plastic G4 gearmotor servo is a very different story. Here's why.

You can get steppers surplus for about US\$5-10/unit. The moment that RepRap takes off, however, surplus steppers are going to evaporate and people will be paying list price for them, which is about US\$50-75/unit. That means that if you are shooting for a US\$400 RepRap the steppers are going to cost you 40-60% of that. Parts for stepper boards are also going to cost you another US\$15 or so in parts when all is said and done. That means that you're talking about 50-70% of your RepRap budget going for just motors and control boards before you even try to build the positioning stages and extruder. That's just not on.

Now I can buy a yellow plastic G4 gear motor retail for between US\$5-6/unit.

<http://www.pololu.com/products/solbot/0181/>

Add a shaft encoder to that and you've got US\$10. That's 20% of the real cost of a stepper. As well, the much lower power draw means that the chips you have to buy to drive the motor are cheaper. Finally, most of the mass and cost of the G4 and it's siblings is in the plastic gear box. The motor itself can be had for maybe US\$1.50/unit retail. The rest you can rewrap if you want.

What all this means is that the cost of your motors and control boards for gearmotor servos for a Vik-sized RepRap is going to be maybe US\$60, and a bit less if you make your own gear boxes.

Now let's do a thought experiment. Let's take Reiyuki's pretty conventional (in CNC terms) gantry design for a wooden RepStrap.

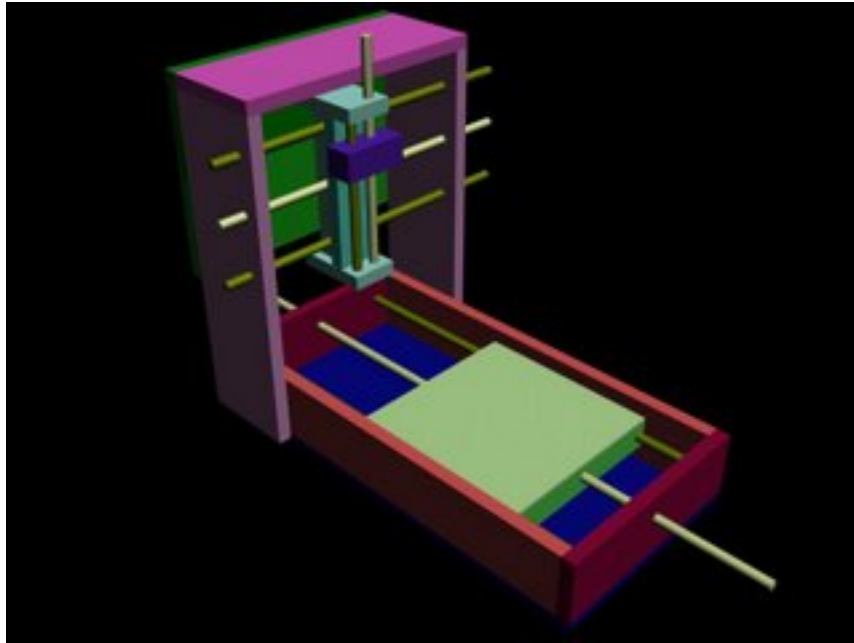

He thoughtfully provides us with a materials quantity survey.

24x48" of 1/8"

48" of 1x2

16" of 1x3

74" of 1x4

78" of 1x6

Doing the numbers you get roughly 17250 cm³ of materials volume. In wood that gives you about 10 kg of material. In CAPA it would be more like 17.5 kg.

If you redesigned Reiyuki's system for CAPA from the get go you can bring that number down to about 3.5 kg. Pushing it harder you could probably shave another kg off of that, but why bother?

What it all means is that a Reiyuki RepStrap could make a full polymer copy of itself in 20 days.

What it also means is that you could make one for under US\$200, everything included... if you went the G4 gearmotor servo route. Double that if you use steppers.

A Reiyuki RepStrap has a 300x600 mm footprint. That's not much worse than most ink-jet printers. Put hoods over those G4's and you will have something that is probably considerably quieter than your ink-jet. Run the whole shebang on 12v power and you're not going to worry about letting it run nights and weekends. Reiyuki's design, when you look at it, isn't all that different than Vik's, which we know works. It uses threaded rods and we don't stress them to the extent Godzilla does. Same general configuration. It scales, too.

If we take my own proclivity for dynamic extruder heads we can probably either reduce the footprint or increase the capacity for a set footprint. I tend to think that G4's running positioning platforms using RepRapped rack and pinions (yes, I've just about got the script running) could make a lighter system still with fewer hard metal parts to buy.

You're can naturally make spare parts for a design like this when you aren't actually using the system for something else. There will be a natural tendency to make spares and keep maybe two systems going for reliability. Two systems not all that much bigger than Vik's have a hell of a lot of extrusion capacity, viz, about 11 kg/month.

The present paradigm has your PC running the RepRap. Put a bigger PIC18F chip in the controller and your PC could handle several RepRaps.

Having spares around is going to give you a natural tendency to help other people get theirs going, too.

Rack those pinions...

Tuesday, 15th August 2006 by Forrest Higgs

Got it!

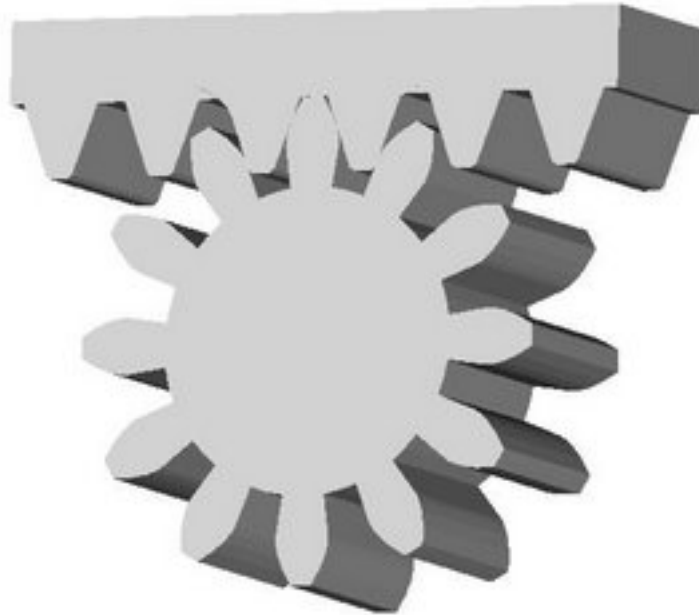

The Lule¥ involute gear script gears and the Kiplinger racks script match up perfectly. I ran the y-zero line for the rack through the pressure radius so that it would be easy to line up gears and racks to check to see if they mated properly.

To check you just make your rack and when doing so specify the number of teeth you want in the pinion. Also make sure that you use the same pressure radius. Once you have your rack done you then make your involute profile gear.

One thing to remember is that if you want to match up your pinion gear with your rack to always specify an even number of teeth in the rack. The reason for this is that the Involute Profile Gear script always places a gear tooth pointing straight up so you need a gap in the rack teeth to seat it without a lot of drama. Once you've done that just select your gear profile and click "object layout". Drop the gear profile in the Y-direction by a value equal to your pressure radius and you will be able to see in an instant whether or not you have a match. It's a dead easy way to avoid design errors.

Half a dozen more scripts like this and Aol will be a proper engineering design CAD system. :-D

I was thinking about short-term, unintended consequences of RepRap this morning. If I remember

correctly one of the big problems in engineering education is getting students hands-on time with machine tools so that they can get some experience about where CAD design leaves off and real mechanisms begin. Machine shops and their staff are extremely expensive in my experience and students rarely if ever rate shop time just to tinker with designs.

It seems to me that RepRap would make it possible to put a good prototyping system in any mechanical engineering student's dorm room. The notion of what a RepRap would do towards improving a mechanical engineering student's experience with actually designing mechanisms completely boggles my mind. A student working with a RepRap could easily leave university with more hands-on design experience than a graduate engineer currently picks up in several years in the field. That's noteworthy to say the least. It would make engineering education both better and cheaper. In commonwealth countries it would mean lots more better trained engineers, never mind in the UK.

That alone, Adrian, should get you at least a knighthood and if the world were a fair place a peerage. A professorship would also seem the least that could happen. I don't know if you've ever entertained those sorts of ambitions, but there it is.

You can get both the Rack and the matching Involute Profile Gear scripts at...

[http://www.sanma12.com/reprap/software/Aol Scripts/](http://www.sanma12.com/reprap/software/Aol_Scripts/)

For you Aol newbies you put these in the "Tools" folder that you find in your "Scripts" folder for Art of Illusion (Aol).

You have to restart Aol before you will be able to see them in the "Scripts" entry in the "Tools" pull-down menu.

One thing Professor Adamson at Lunds Technical University taught me was that the fastest way to see if you had bugs in computer code was to test extreme examples. Here is one.



Looks good. :-)

One thing I have noticed is that you need to keep an eye on the Aol extruder facility when you are extruding your rack. Occasionally it will put a little two dimensional web across part of the bottom of one of your rack teeth. You can generally see it as a wrinkle in the sides of the rack when you view it in Aol. I don't know why that is, but you should look out for it. I've found that increasing or decreasing the number of teeth in the rack makes it go away... for now...

Please remember that while the Involute Profile Gear script has been knocked around a bit, the Rack script is a very early beta release. Please let me know if you find any problems with it.
Thanks! :-)

A hole in my theory

Wednesday, 16th August 2006 by Simon McAuliffe

I missed the obvious in my RepStrap...

The axes wobble a bit due to the plastic sleeving used to connect the motor shaft to the studding. The sleeving slowly moves off-center from the weight of the load. Then when the motor turns it causes a wobble.

I suddenly realised the obvious. Most steppers have a little hole down the shaft. A pin inserted into the hole and then into a matching hole on the studding would keep them nicely centered and the plastic sleeving would then do a great job. The pin would be held in place by the sleeving too, so it's a very simple solution to the problem.



First part printed by Zaphod

Thursday, 17th August 2006 by Vik Olliver

Two announcements in one, really. The new machine has been christened "Zaphod" on the grounds that it is going to have two heads. But with just one head installed it has printed out a linkage part, the first printed by a RepRap. Here it is just after printing, a process that took 35 minutes and used about 1.7cc of polymer:

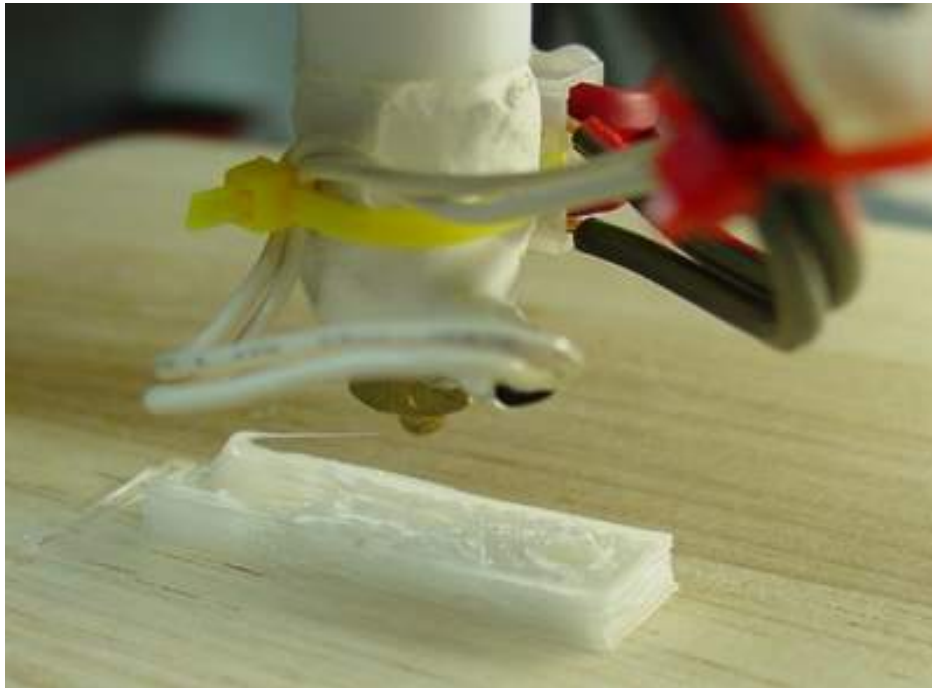

Here it is prised off the deposition surface and next to a scale. I left sprue & cobwebbing in place for this photo, but that mostly vanishes when you wave it over a blowtorch:

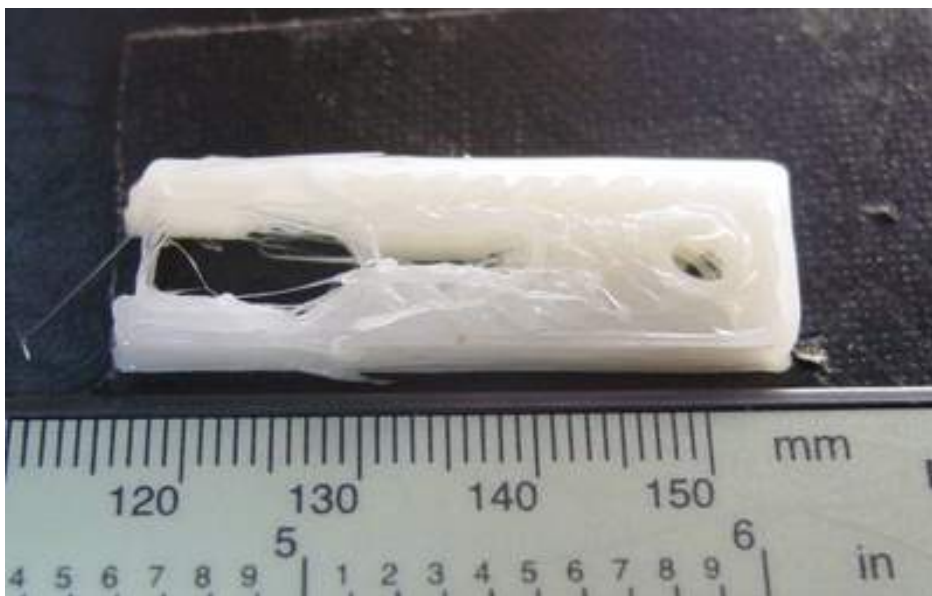

Now, all those people who said it couldn't be done can start contemplating tasty recipies for their words.

Vik :v)

RepRap To Go

Monday, 28th August 2006 by Vik Olliver

The Zaphod prototype has now acquired its second head, and the entire machine is now portable. At least, I can carry it out onto the deck without putting my back out.

The RepRap 3D software and ArtOfIllusion are now running nicely on the Linux laptop - should work just fine on a Windows laptop too, I just don't have one.

All this means the RepRap is now ready to go to Vienna on the 8th September for Paraflows '06 and for its TV debut on Taugshow on the 16th September. Zaphod is very excited about meeting the public and being on TV.

Vik :v)

Biting the KiCad bullet...

Friday, 1st September 2006 by Forrest Higgs

I finally decided to take a little time off and learn KiCad so that I can document some of the boards that I'm building. I went back and read over Adrian's 5 March entry in the Developer's blog. From that and looking at the schematics I have the suspicion that I might be the only one to be actively using it to document things.

Here is the paper trail on it...

Simon (11 January):

Vik made a great discovery of a package called Kicad.

It's a complete integrated schematics -> PCB system and it looks pretty good. It's fully GPLd and multi-platform. I was just playing with it before and it's pretty simple to use. I built a schematic and took it right through to the PCB stage quite quickly. It can also produce SVG of schematics, and mirrored postscript of copper tracks for quick and dirty UV optical etching.

Adrian (5 March)

I'm about to blog my experiences with 1) kicad and 2) laserprinting

and Adrian blogged that same day that...

...took me about an hour once I got up to speed. Kicad's automatic PCB layout tools are almost useless, but its systems to assist manual layout are very good - they are clear, and don't allow you to make mistakes. Here's the PCB for the above circuit:

Vik (27 June)

We're looking at kicad, gschem and eagle.

From what I've seen so far KiCad looks to be open source or while Eagle is a commercial package that has a limited use free edition. I'm not fond of "limited" free editions, so I'm going with KiCad.

So far, so good. The first thing that becomes apparent is that some of the chips that we're fond of aren't in their library. They have an editing feature in KiCad, but as Adrian suggested in his blog entry, it's about as easy to just cut and paste in the library files, since they are in ASCII. One thing Adrian didn't mention probably because it didn't happen to him, if you edit the library files using a

text editor be aware that the code in KiCad that reads those files isn't idiotproof, so if you make a typo while editing and then try to start up the schematic programme, it will explode. Don't let that alarm you, just go back and check your library editing. You probably just have a typo.

One thing to keep an eye on. There are a number of library files in the library folder that aren't activated in the eschema (schematic... this is French software, but don't let that put you off) Before you go to a lot of trouble to put in a new chip schematic check those libraries. I was about to bite the bullet and put in the 16F877A when I found a very useful copy of it in an inactive library. I just cut and pasted that into the Microchip library and I was good to go.

Anyhow, I couldn't find our H-bridge chips so I'm doing schematics for them as practice. Here is the 754410...

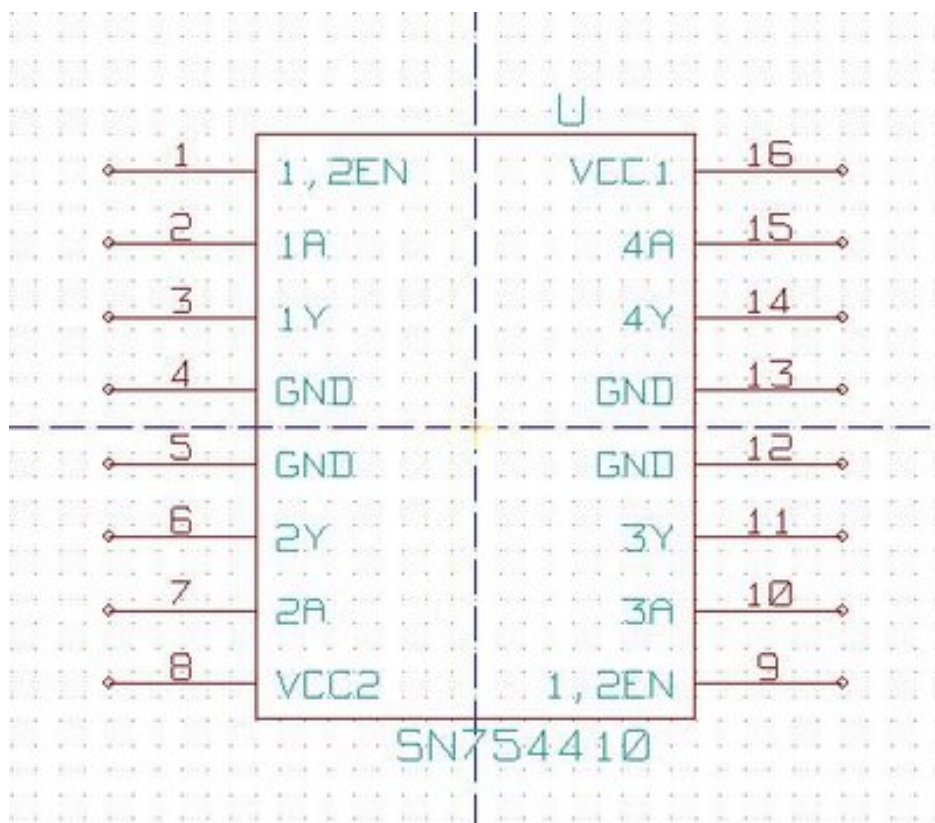

I am also going to do the L298N H-bridge, the AS5035 shaft encoder chip and that Hamamatsu limits detector chip that I can't remember the number for right off hand. If anybody is going to use those give me a yell and I'll send you the altered libraries. I'll put them in my resources folder as soon as my server is operational again, which will be next weekend, I think.

Common components for KiCad

Saturday, 2nd September 2006 by Forrest Higgs

I went ahead and created components for the usual sorts of things that we use around here.

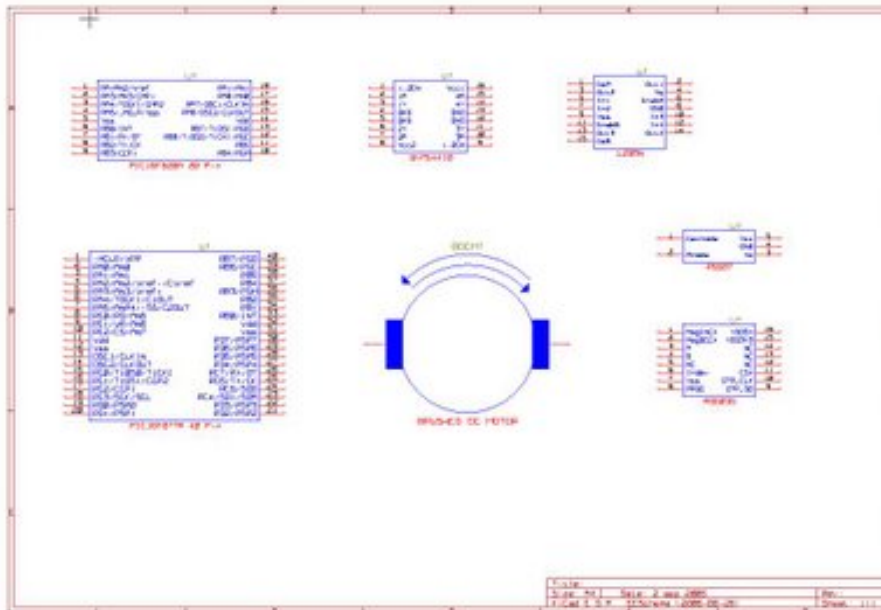

Most of the components we ordinarily use are already in KiCad's libraries. These include the 16F628A and the 16F877A. I just hate the serendipitous manner in which they distribute pins on their IC's though, so I went ahead and did them like they are on the data sheets.

We're going to have newbies trying to build these boards and it's confusing enough trying to see what connects to what without some boffin playing 52 card pickup with the pin numbers on the poor okies.

Anyhow, if anybody needs the new library, let me know and I'll email it to you. My server is still down. :-)

BTW, I've already seen the typo with the 16F628A. I called it a 20 pin chip when it is actually an 18. I fixed it but don't want to generate a new sample sheet this evening.

The mystery deepens

Sunday, 3rd September 2006 by Forrest Higgs

I got the Solarbotics gearmotors in today. I laid the little yellow gearmotor that Adrian sent me months ago alongside the GM3 that I bought and I can say this.



If these weren't made for the same manufacturer they were made by the same factory, somewhere in Guandong province in the Peoples' Republic, I suspect.

The mounting holes on the case are identical as is everything else right down to the distortions to the outside of the case that come as a result of reinforcing struts inside cooling in the injection molding dies.

The gear ratios are different, I suspect, because of a change in the nature of the windings. The motor cases are identical.

There is no need to change the Mk II STL file for the mounting block for the gearmotor.

I bought the GM3 with its 38 rpm peak rotational rate largely because I didn't need all that much rotational speed on the Mk II polymer pump motor and I wanted to put a shaft encoder on it. Dan at Solarbotics said that he would be more than happy to plunk the GM9 gears into the GM3 gearbox if we needed that higher rotational speed.

The mounting holes on the GM8's with its different gear box and motor orientation are in a different place. This shouldn't be a problem, though.

Ah ha! There is a difference. While the drive shaft is a double flat on the Solarbotics just like the one Adrian has it is enough bigger that it is too robust to fit in the motor coupling that he made for the Mk II.

Use of Castable Bearings in RepRap

Monday, 4th September 2006 by Nick



Apologies for the delay in posting this....

A few weeks ago I attempted to produce some bearings using Field's metal and RP moulds. The aim was to prove that it was possible for a RepRap machine to produce its own bearings, as Field's metal melts at approximately 70 degrees celcius.....

I tried 2 methods

1. Casting the metal in a mould with the 8mm steel bar in situ, using silicone grease as a spacer.



2. Casting the metal in a mould with a plug that could be hammered through once the metal had solidified.

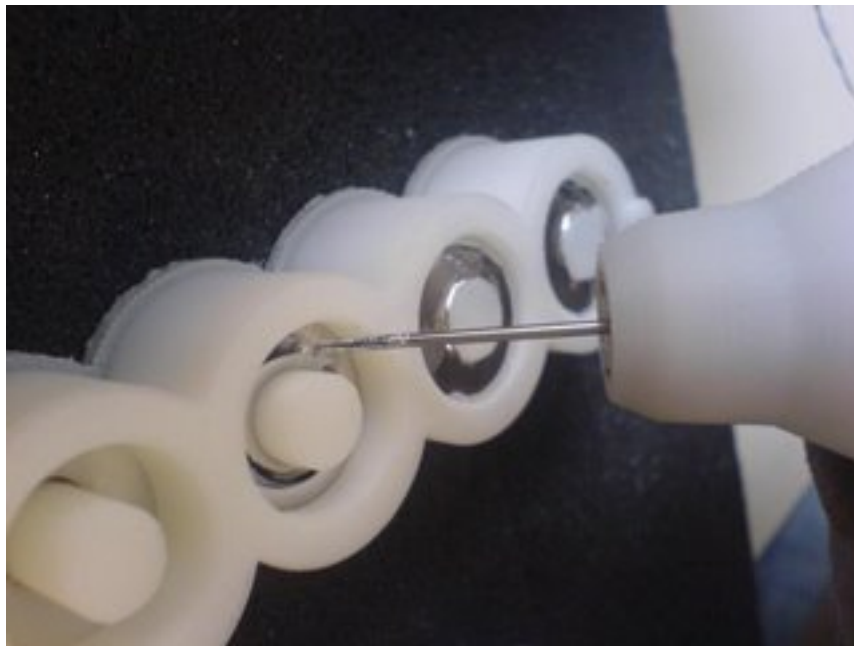

Method 1 failed as a bearing (but would be good as a locating/fixing mechanism - ie calibrate machine, then set all joints in metal)

Method 2 produced some nice bearings..... (Only tested by hand so far)

The Moulds

Method 1 - 3 hole mould and cap used to locate the rod and seal the base.

Method 2 - 6 hole mould with varying plug diameters, the support material needs to be left on to hold the plug in place.

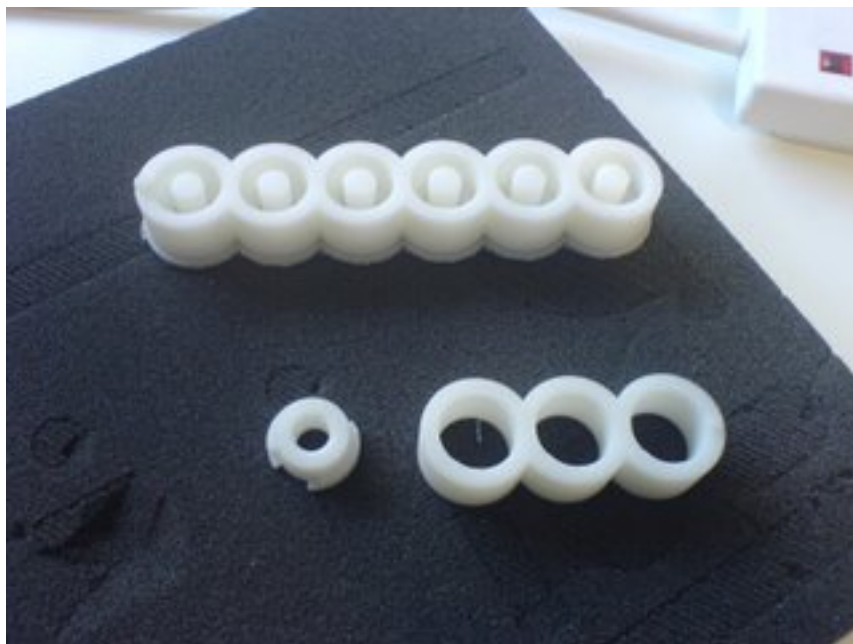

Moulds 1 & 2 and concentricity cap, and the finished bearings (before knocking through plugs)

The best results were achieved with a centre plug diameter of 8.2mm (to fit an 8mm bar)

Will be performing some basic tests on them this week

Full report available if anyone is interested

RepRap on display in Vienna

Sunday, 10th September 2006 by Vik Olliver

Greetings from Vienna, or as they say in these parts "Servus!"

Zaphod has survived the trip, and despite having flown Auckland-Sydney-Bangkok-Dubai-Vienna sustained remarkably little damage (a few disconnected wires, a detached circuitboard and a broken fan housing). The Vik however was totally knackered, and took about 3 hours to reassemble the pieces.

Aha! Found the apostrophe on this QWERTZ keyboard (or kezboard as I keep doing).

We've had a wonderful reception by the Paraflows '06 organisers, and the Metalab - particularly Philipp who is kindly putting me up for the duration. I am sorry I was not awake enough to go out on the evening festivities with Angela and her loyal crew. Hopefully we will have other opportunities.

The press have been throughly primed, and even Google News in Austria has picked up a link :)
Here

But now, time for breakfast in Vienna.

Vik :v)

RepRap Makes a Name for Itself

Wednesday, 13th September 2006 by Vik Olliver

After a late night session and early morning session supporting Metalab and apparently a few of the local breweries, the RepRap has finally made a name for itself:



It looks like we'll have to take greater care not to route the nozzle over gaps in the artifacts so as to avoid all the "hair". But at least we know that the mechanism is actually capable of producing reasonable volumes of output without breaking down, and I can confirm that I can hand-roll 3mm filament faster than the RepRap can use it!

More from the opening of the Metalab exhibition here:

http://esel.at/gallery2/v/dokumentation/paraflows/paraflows_opening/paraflows__opening_metalab

Vik :v)

Quick update from Vienna

Thursday, 14th September 2006 by Vik Olliver

Things are going astoundingly well here, except for networking issues which prevent me from uploading pictures. But it is probably worth mentioning that last night I completed the first full part for the RepRap and I'll be fitting it this morning. It's the largest thing printed so far containing - if I recall correctly - 4.4cc of polymer and taking 1hr 10 mins to print out. The improved print speed is due to the lack of excessive head cooling during the workpiece cooling cycles. If you look at the Youtube clip (see comments to previous entry) you'll see that I've chopped up a clear plastic bottle to create a windshield.

Rolling 3mm polymorph by hand has been part of my life all week, and it's good to hear the news from the builder's blog that it might be possible to get pre-made filament.

For those in Vienna, check the Metalab.at site for details on tonight's "How to build your RepRap" session and come along to this morning's brunch if you can. Tomorrow, we shoot the Taugshow interview, which given Johannes Grenzfurthner's reputation (see his Wikipedia entry) should be very interesting - for me at least!

Vik :v)

First Working Part Printed & Fitted

Saturday, 23rd September 2006 by Vik Olliver

This part was printed at 10:10pm Austrian time on the 13th September 2006, and was fitted the following morning (I got carried away celebrating the moment, OK?). For the record, it involved 15390.4 mm of travel, 11240.9 mm of extruding, has a volume of 4.777 cm³ and took 6690.9s to print (about 1 hr 50 mins). Oh yeah, it works.

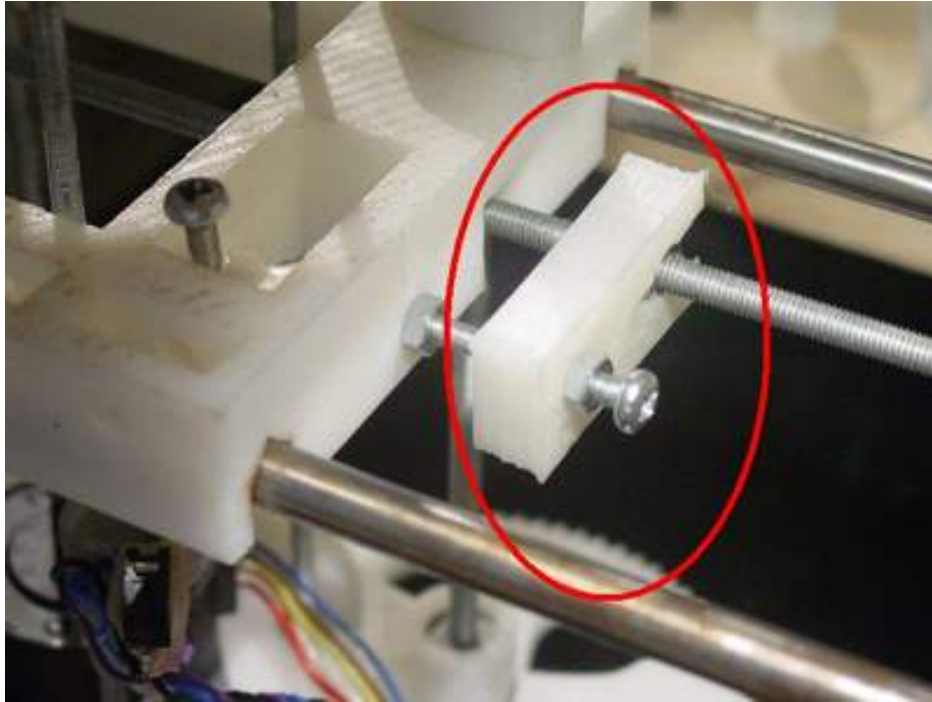

Vik :v)

RepRap Interview on Austrian TV

Friday, 29th September 2006 by Vik Olliver



Last weekend's "Taugshow #6" featuring an interview section on the RepRap by yours truly aired on Austria's Okto TV channel and is now online here:

<http://www.monochrom.at/taugshow/taugshow6.htm>

It's 300-odd MiB. For those skipping through it, I'm the longhair in the orange T-shirt in the latter half, as seen here on the right.

Vik :v)

Involute profile gear tooth script pathology.

Sunday, 8th October 2006 by Forrest Higgs

Now I can see what's happening. After reviewing the Luleå Tekniska Universitet example and going back and working with the script that we are currently using I'm pretty sure I know what is causing the script pathology.

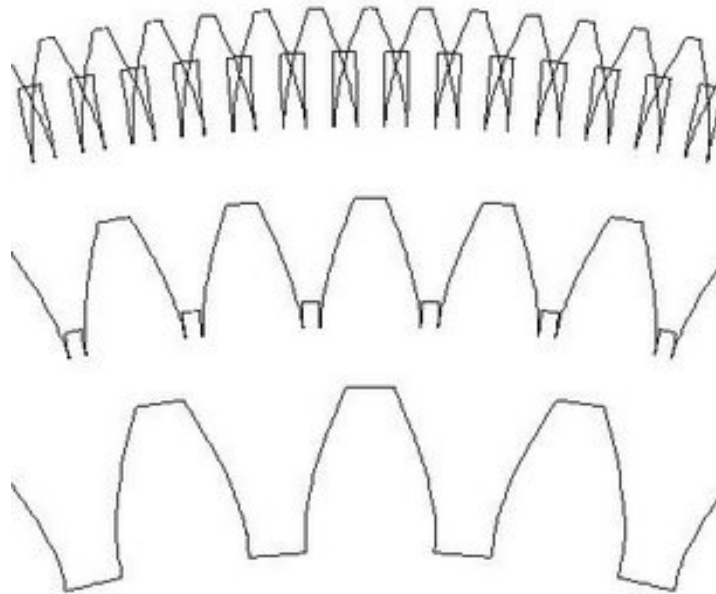

If you look at this screen grab pulled from Aol you can see pretty clearly what's happening.

I've run the script for three gears; 40 teeth with a radius of 1.5, 75 teeth with a radius of 1.75 and 200 teeth with a radius of 2.

The 40 toothed example works right. You can see the line that describes the bottom of the tooth which connects to a radial line that runs up to where the involute profile curve begins. That line at the bottom of the tooth should be an arc, but never mind that for now. In the script code it is called RI. The radius where the involute profile begins is called RB.

If you will look at the 75 toothed example (the next one up) you see that what has happened is that the value for RB has become less than the value for RI.

That is what is causing the pathology.

If you then look at the 200 toothed gear at the top you can see that RB has been driven down to a point where the two involute profile curves are actually overlapping. The gap between the teeth is actually higher than the crossing point.

It appears that what I need to do is make sure that the involute profile curve can never extend below the boundary defined by the radius R_I .

I'll try to fix that now.

Here's the fascinating part, though. I was looking at that 200 toothed gear at a high magnification and realised that it is approximating a rack!

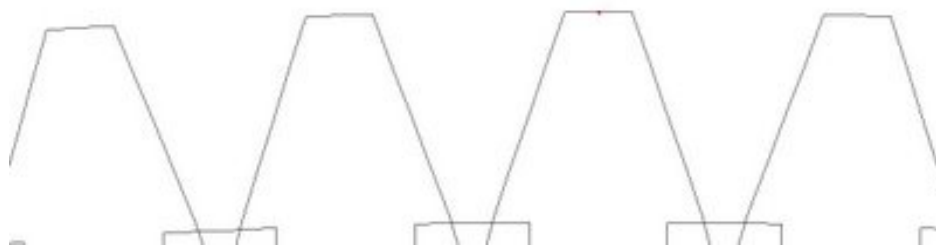

A rack can be considered to be nothing more than another involute profile gear with a extremely large radius and number of teeth. That may well let me use the same script for both rack and pinion!

Woo Hoo! :-D

More work on the involute profile gear script for Aol

Sunday, 8th October 2006 by Forrest Higgs

This morning I was cleaning loose papers from under my PC table and discovered the printout of the original example code for generating the gear profiles from Luleå Tekniska Universitet. I had neglected to download a copy and simply printed out the PDF file. After I'd got the Aol script going the printout slid off the back of my PC table into the drift of similar papers that collects back there. I'd been unable to get recover the link to the document via google since then.

Anyway, once I had the printout I googled a sentence out of the document and got the document back. You can link to it [here](#). I also grabbed a copy and dumped it into the documents folder of the RepRap folder on my own server so that we will still have a copy of it if, for some reason, Luleå takes that document down. You can link to that copy [here](#).

Some of you might want to keep copies of this rather vital document so that the RepRap project still has it regardless of server and disk crashes.

BTW, the example code begins on page 444 of that Swedish document (page 20 in the PDF).

There is also a copy of Cory Doctorow's short story "Printcrime" in there. :-D

I am going to spend some time going over the involute profile gear script for Aol again this morning to see if we actually have a coding problem in the original Swedish programme or perhaps a misinterpretation of what they meant when I translated their logic over to VB.NET and thence to Java.

Upgraded Aol Involute Profile Gear script...

Tuesday, 10th October 2006 by Forrest Higgs

Okay campers, I got it done and tested for a first cut. My opinion of Java does not improve with acquaintance. I don't see how you guys can stand to work with that Sun "compiler". I won't say more than that.

Anyhow, you can get a copy of the new script which is called "Experimental Involute Profile Gear" to differentiate it from the older script that I wrote some months back. You can get a copy [here](#).

I made a few screen grabs of some gear pairs that I did with the new script. I did Vik's 79 toothed gear and mated it with an 11 toothed gear.

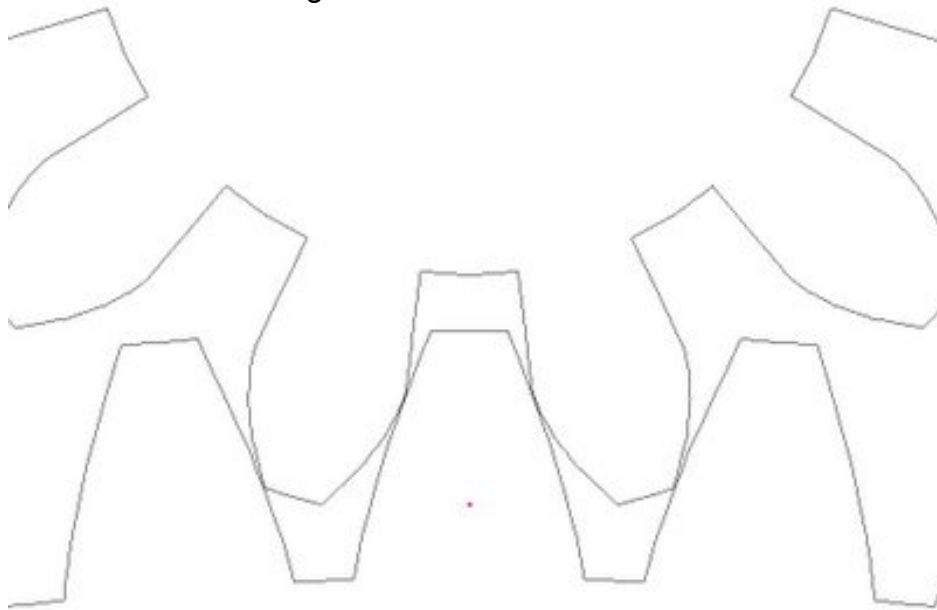

The pressure angle used was 20 degrees.

After I'd done that I decided to really test the robustness of the routine by pressing the envelope.

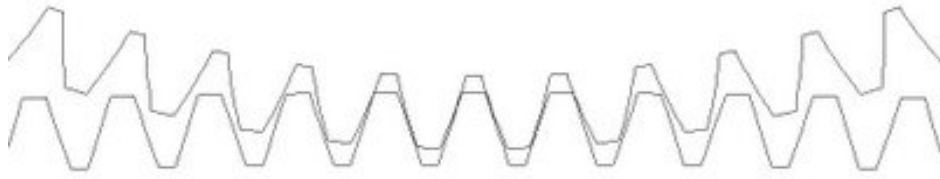

Here is a 99:1200 ratio gear pair also done with a 20 degree pressure angle.

I then checked to see that I could triangle mesh the profiles and extrude them. There doesn't appear to be any problem. Here's Vik's example again.

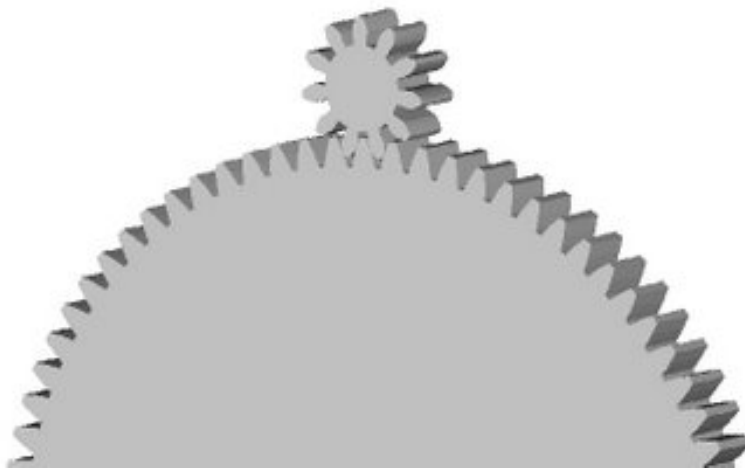

Don't run this script with pressure angles larger than 25 degrees, please. I don't want to have to debug any more `##@##` Java again for a few weeks, thank you so very much. :-/

Finally, here is an example of what I am talking about when I speak of using the same code for both rack and pinion design.

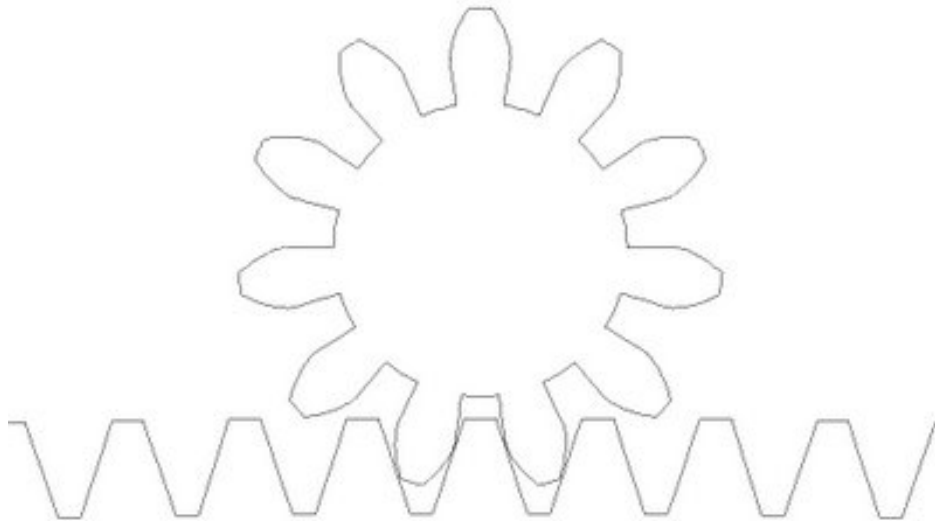

Here you have a 11:1201 ratio gear pair. The 1201 toothed gear for quite reasonable distances is very much a rack for the 11 toothed pinion gear.

Upgrading the Aol Involute Profile Gear Script...

Tuesday, 10th October 2006 by Forrest Higgs

It appears that a decent fix for the too many teeth pathology in the involute profile gear script is to simply chop off anything that the script tries to draw that falls below the inner radius. I've written and tested the code for that in VB.NET 2005 and the results look good.

I've tested it up to a gear with a radius of 1000 and 360,000 teeth. The teeth are triangular with the top of the triangle chopped off at that resolution, but hey, what did you expect? :-). It very much looks like I can generate a rack with this coding by using a very large radius and then doing only a partial, very shallow arc.

Right now I'm translating the code into Java so that Aol will eat it. That task is about as much fun as getting an onlay at the dentist's on a rainy afternoon.

I'll publish some screen grabs from Aol and pass around the script as soon as I get it running.

The code appears to be robust as long as you don't specify a pressure angle higher than about 25 degrees. That shouldn't be a problem.

Bug fix on the Experimental Involute Profile Gear script...

Sunday, 15th October 2006 by Forrest Higgs

Vik was testing the Experimental Involute Profile Gear script this weekend and discovered that I'd left an active print statement in the code. I've commented it out in the uploaded script that you can get [here](#).

CAPA filament arrives...

Monday, 16th October 2006 by Forrest Higgs

The CAPA filament that Image Plastics made up for us arrived a little while ago.



As you can see it looks beautiful.

I measured its diameter in about 5-6 places and on the downside it's running 2.8 mm +/- 0.009 which works out to 0.11 inches. A diameter of 3 mm works out to 0.11811 inches.

The consistency of the filament is what Jim said it would be but the filament itself is 0.2 mm too thin. I'm guessing that somebody's vernier is set in inches and somebody set the filament winder wrong. I'm going to talk to Jim about this in the morning and see if that's all the problem is.

Vik tells me that the Mk II will happily eat filament ranging from 2.7-3.0 mm so this batch isn't wasted. Perhaps we can put an initialisation datum of the effective filament diameter in to the Mk II controller programme so that we can keep track of mass flow very accurately.

Rethinking the Mk II heater nozzle...

Tuesday, 17th October 2006 by Forrest Higgs

We know the Mk II works. It has been the major breakthrough that makes the rest of RepRap possible.

I'm currently making a serious effort to get a Mk II going. As usual I can't ever seem to leave well-enough alone, though. :-(

The heater nozzle assembly of the Mk II has always been the most fraught for me.

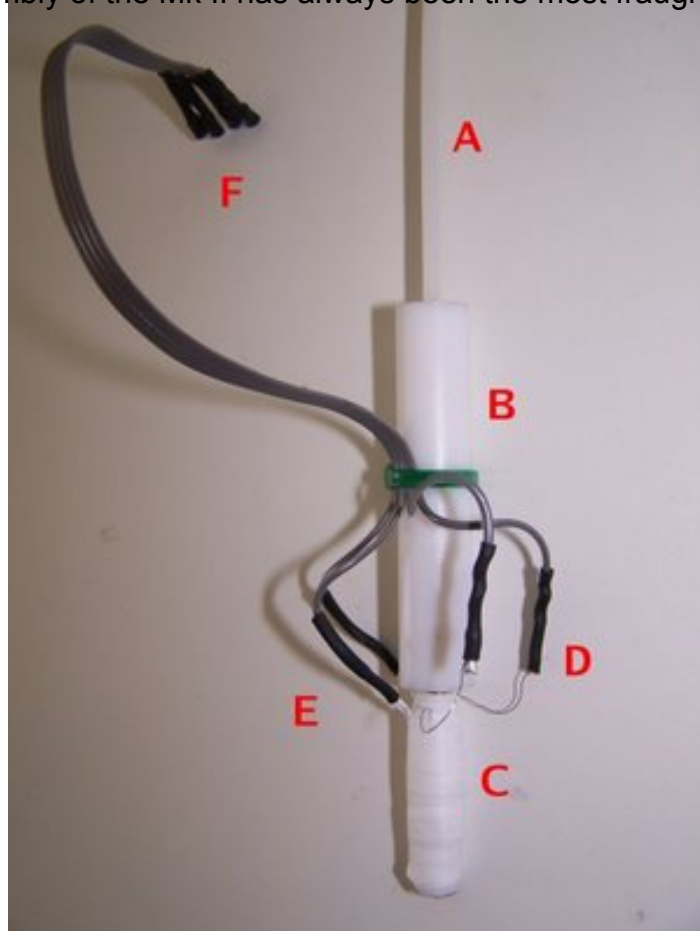

It has always struck me that for something that is supposed to be made in the wilds of Africa that part of the assembly seems remarkably sophisticated.

First off, you really need a lathe to make the brass heater nozzle.

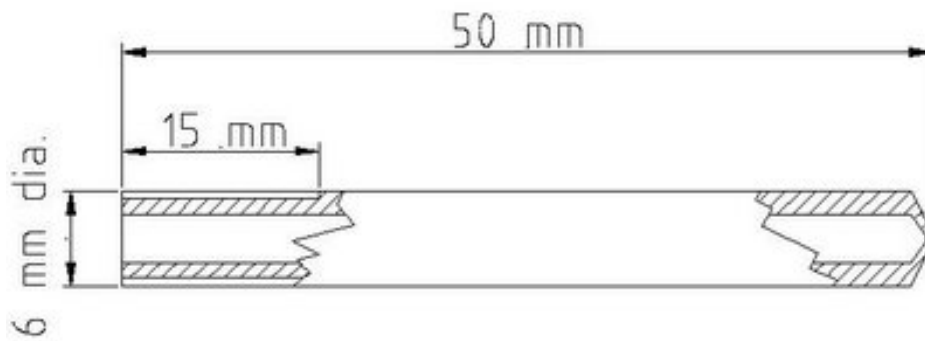

You might as well need a lathe to run a straight hole through several inches of PTFE rod.

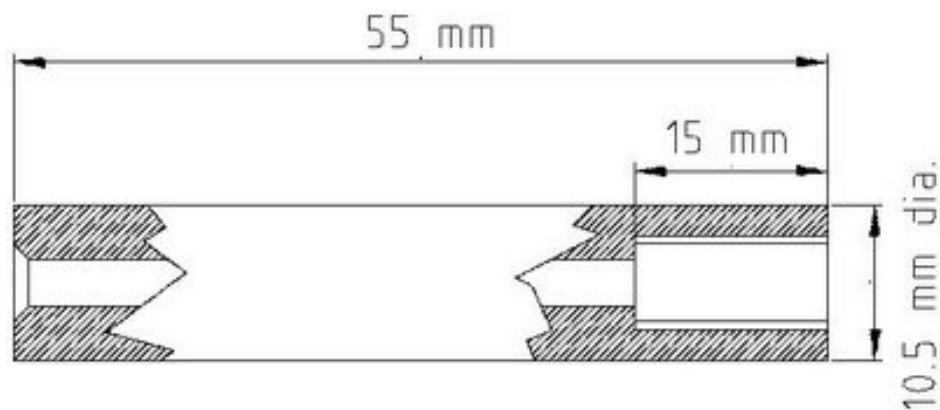

I've tried it a number of times both freehand and with a drill press with a cross slide vise. I finally had to drill a hole in a block of wood and slide the PTFE rod into that to even hope to get the job done properly. It's a real pain for a retard like me.

One thing that bothers me about that heater nozzle, aside from the fact that it's a bugger to make, is that it has a lot of material in it and as a result has a considerable time constant.

As designed by Adrian the thing has just over a cubic centimetre of brass in it. Depending on the brass you use that's about 8.5 grammes.

In order to make it easier to unjam Vik has added a nut onto the end of it.



That's handy but it adds more mass onto the nozzle and thus increases the time constant.

That seems to have become the standard heater nozzle design for right now. Here's a neat one done by TylerM.



Okay, so we have a way to do it. Problem with the one we have is that it seems to be a fairly finicky thing to make. You also need to screw it into that PTFE rod.

In practice Vik has discovered that he has to periodically park the extruder and also needs to keep a fan on it to make it work right.

I got to wondering if you couldn't somehow make one somewhat more easily. This evening I took a shot at doing a mockup of one that I could make in the wilds of Africa if I needed to.

I've been eyeing some 5/32" hard copper tube in the hardware for some weeks. A foot of it costs US\$0.75. This afternoon I took my micrometer and a piece of the CAPA filament that Jim sent along to see if would fit.

Sure enough the CAPA filament fit wonderfully into the hard copper tube. The inside diameter is spot on at 3.05 mm. Unlike the ones we are making now, however, the wall thickness of this premade tube is only 0.47 mm instead of 1.5 mm in the original lathe-made heater nozzle.

The whole diameter of this 3 mm ID tube is only about 3.94 mm. An equivalent length of this stuff weighs only 2.54 grammes as opposed to just at 8.5 for the original design. That's about 70% lighter than the original design and the good Lord only knows how much lighter than the one that has a nut on the end.

I had some 25x25 mm PTFE block lying around from some earlier work with the auger bit extruder I designed months ago. I had bought it to give strength to the 1/2 inch rod that I used to separate the auger pump from the heater barrel. I'd discovered that when you pressurize PTFE when it's hot it bulges.

It struck me that that 25x25 mm cross section bar would be a heck of a lot easier to seat in a cross-slide vice on a drill press. As well, you could bolt it to the bottom of the Mk II's polymer pump instead of using that friction grip that Vik had noted tended to slip when you overpressured.

So, here's what I did. I didn't want to screw or friction fit the copper tube into the PTFE. I made a flaring mandrel out of a piece of scrap steel by drilling a 5/32 inch hole in it then countersinking a 1/4 inch hole into it to make a flaring die.



Once I'd made that I cut a 55 mm piece of the tube.

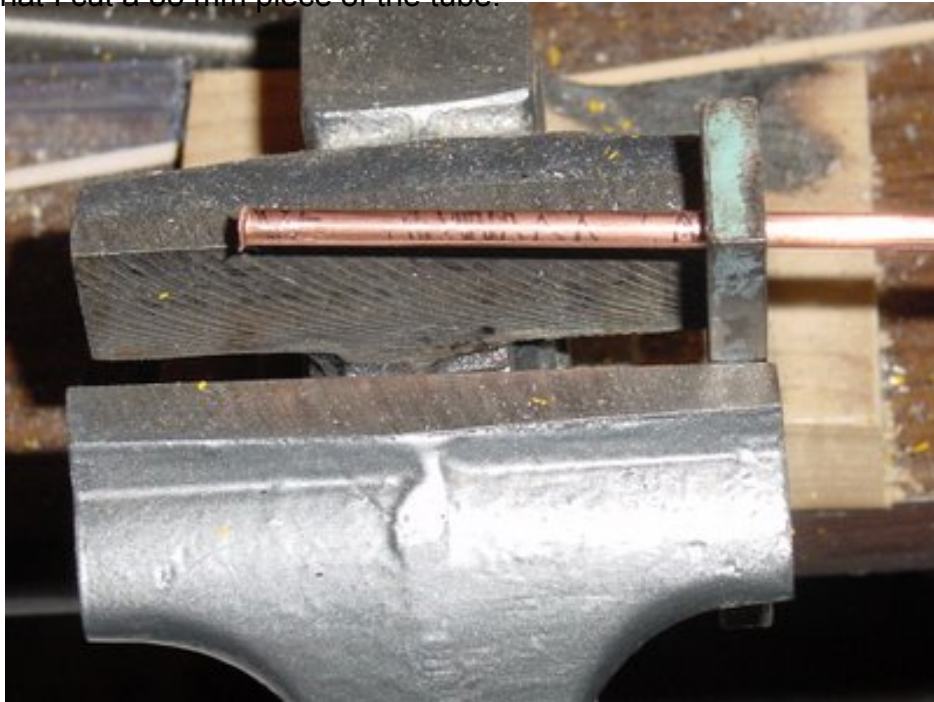

The die serves as a good way of gripping the tubing while you use a hacksaw on it.

I then used the 5/32 inch drill bit run backwards to create a lip on the end of the tube.

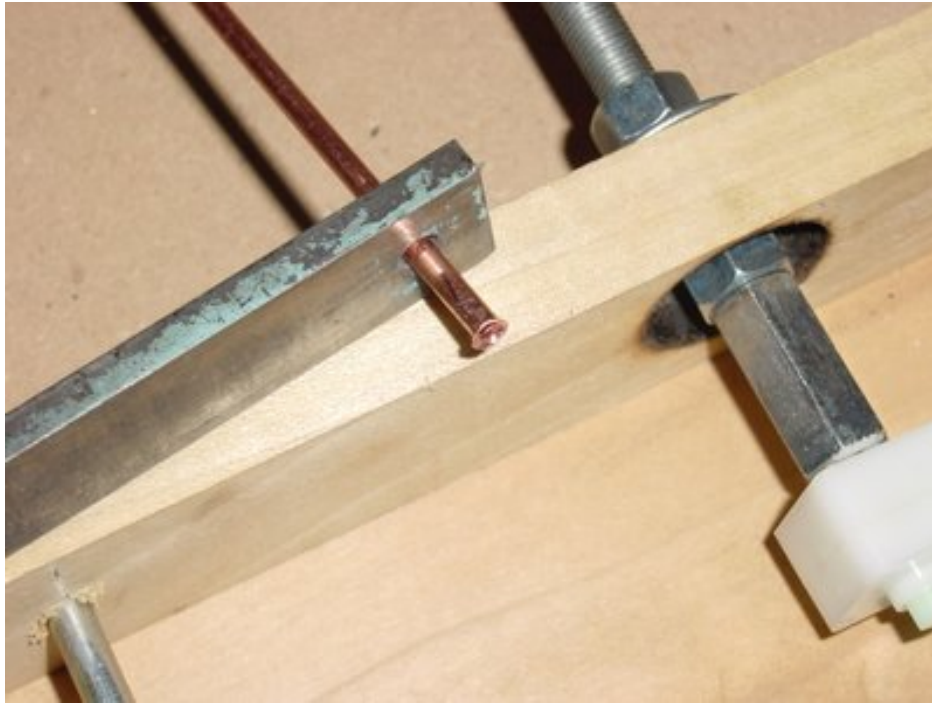

After that I cut a square washer for the flared nozzle out of 0.7 mm copper sheet (the kind you engrave stuff on for trophies or discreet business signs by office doors.



It's good to secure this stuff between two scraps of wood when you saw it so that you don't warp it.

After that you seat the heater nozzle in the washer.



I set out to buy a 0.5 mm drill bit but was only able to get a 1 mm drill bit, so I used it for this exercise. What I did instead of drilling with it was to use it to form the extrusion orifice when I crushed the end of the copper tube down on the drill bit.



Afterwards I realised that any steel wire of the proper diameter would have done the job just as well.

I touched up the nozzle with my Dremel tool.

I was then ready to saw off a piece of 25x25 PTFE bar and drill it to seat the heater nozzle.

What you wind up with is quite a robust heater nozzle assembly.

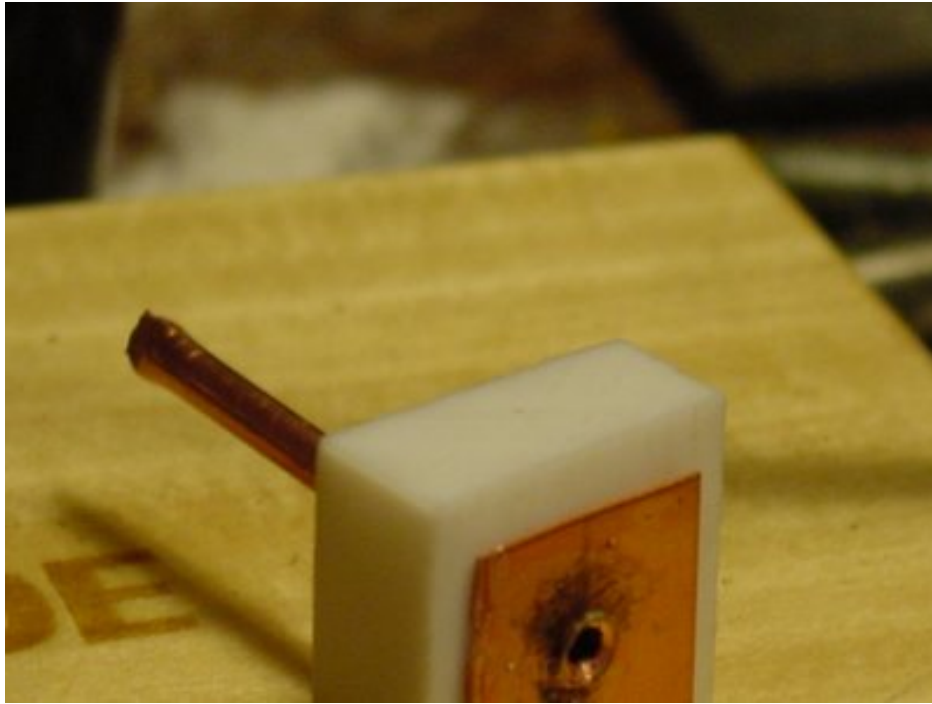

Here you see it with a piece of CAPA filament fed into it.

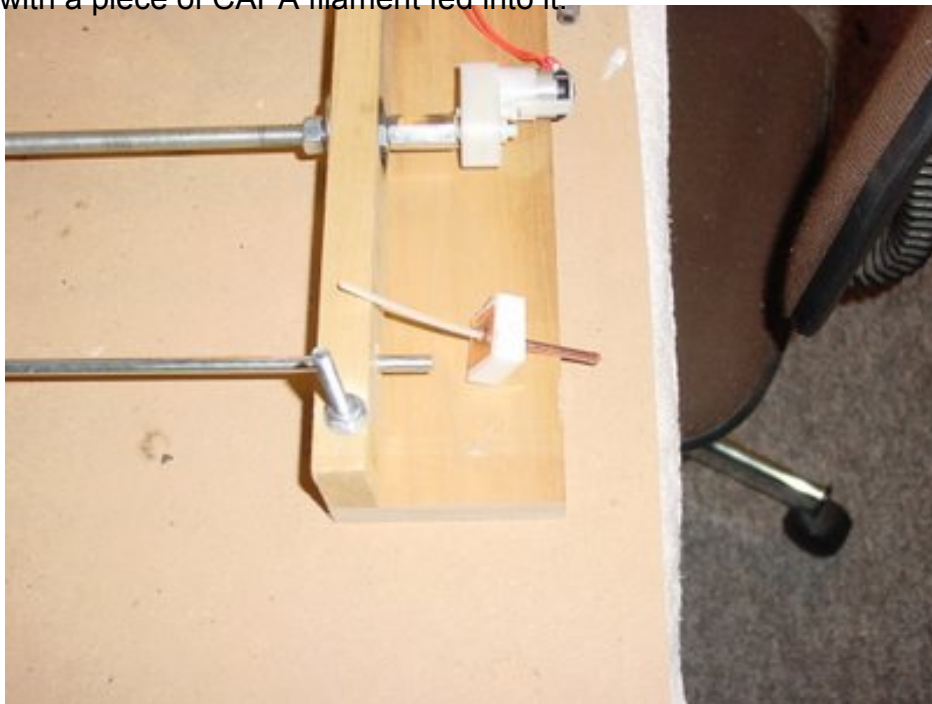

You then make your PTFE filament guide and thermal barrier out of a 50 mm piece of 25x25 mm bar stock and drill the 3 mm hole through it's centre. You can then secure the heater nozzle assembly to the thermal barrier by drilling a hole at each corner of the bar stock and securing it to the polymer pump assembly with something like M3 studding and lock washers and nuts.

What I'm hoping I have here is a heater barrel and nozzle that is easier to make that can handle higher temperatures and heater barrel pressures so that we can try some other polymers like PLA,

HDPE and polypropylene. With a little luck the smaller thermal time constant for the heater head will make it more quickly responsive to energy input changes and reduce the need for setting it aside occasionally.

objects.reprap.org

Monday, 23rd October 2006 by Sebastien Bailard

Just to let everyone know:

I've set up a MediaWiki at http://209.59.209.105/mediawiki/index.php/Main_Page. We'll be using this for our object file library site, objects.reprap.org. Currently "objects.reprap.org" doesn't point at the server, 209.59.209.105, but I have every expectation we'll sort that out shortly.

You are welcome to log onto it, upload files onto it, try to break it, etc. I'm going to be working on it quite a bit, but it should be fairly stable. Features, bug fixes, etc, will be in no small part community-driven, so please email me if it doesn't do what you want. Also email me at (penguin at supermeta dot I-hate-spam-too-so-delete-this-bit dot com) if you want administrator access or an ssh account on the server.

Edit: If you want to help work on the site, let me know - the more the merrier!

The 'Fab @ Home' project

Monday, 23rd October 2006 by Sebastien Bailard

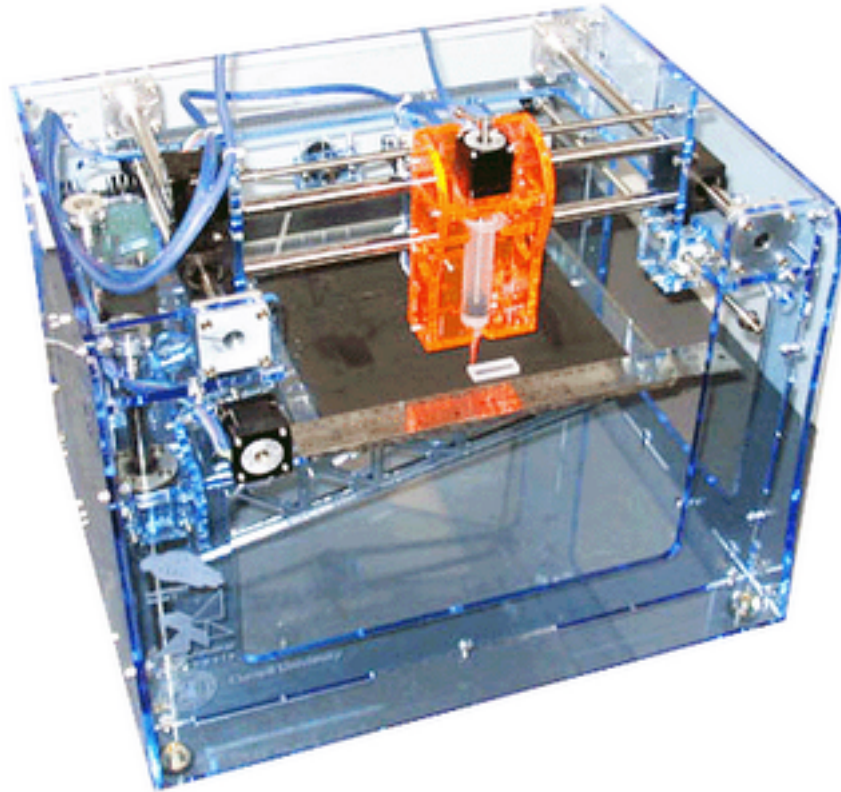

Evan Malone and Hod Lipson at Cornell have done some nice work;

They've got a syringe-based 3D printer, with full plans, up at:
http://128.253.249.235/wiki/index.php?title=Main_Page

It doesn't make copies of itself or work with thermoplastic but it's quite impressive. The printer is made from laser cut acrylic sheet. "Approx. \$1500 RP system", according to a person who saw a talk by them.

It might be worth talking to these fellows and seeing if they would like to work together with us. I'm curious what license they're going to release his work under, what precision they're working at, and so on. They know about our project - they mention RepRap in their [overview](#).

I think it would be extremely worthwhile to merge some of our work with theirs, if we can sort out architectures, GPL, and so on. What do you guys think? At the very least we could use their system as a RepStrap, similar to Vik's [flat-pack-RepStrap idea](#).

Polyethylene glycol as a potential water-soluble support mechanism.

Monday, 23rd October 2006 by Sebastien Baird

I don't think it's a good

Polyethylene glycol

http://en.wikipedia.org/wiki/Polyethylene_glycol

and have been thinking about picking some up and trying to use it as a potential water-soluble support mechanism. PEG is a flexible, non-toxic water-soluble wax-like polymer, used in cosmetics, toothpaste, and Dr. Pepper, along with who-knows-what else.

Jesse Brennan pointed out that Lee Valley sells PEG 1000 and PEG 1450 for CAD\$6/lb (USD\$11.25/kg). PEG 1000 melts at 37C, PEG 1450 melts at 43C. (PEG x means PEG with a molecular weight of x). Lee Valley is an expensive but high-quality Canadian woodworking tool store. They sell the PEG as a "green wood stabilizer".

via a random MSDS, <http://www.jtbaker.com/msds/englishhtml/p5029.htm>

"Melting Point:

Melting point increases as molecular weight increases: PEG 400 = 4-8C (39-46F) PEG 600 = 20-25C (68-77F) PEG1500 = 44-48C (111-118F) PEG 4000 = 54-58C (129-136F) PEG 6000 = 56-63C (133-145F) "

I do not know if we will be able to shape this stuff into filaments, but aside from that, it might work well for us.

More on filament and threaded rods...

Friday, 27th October 2006 by Forrest Higgs

I took off a few days this week and drove down the coast to visit a few potential outfits that could potentially make parts and supplies for reprop.

Noll, Inc. down in San Luis Obispo offers a good range of Acme threaded rods and associated parts like thrust collars and bushings in a size range that would suit our reprop developments. The advantage of using acme rods are that they are accurate in the micron range, unlike the studding that we have been using.

The Acme thread rods are done in stainless steel and run in the range of \$10-15/foot in the diameters and thread pitch ranges that we could use. They also offer thrust collars in anti-backlash designs for about \$30. This stuff isn't cheap. Overall, however, it might be more cost-effective than studding in that we are having to do all sorts of things to force studding to do what we want that we could avoid having to do if we just went straight to Acme threaded rod.

Here are some details that I didn't know about before, though.

- the stuff comes in standard 6 foot lengths
- you can either pay them to mill the ends to fit bushings and motor couplings or do it yourself, which means that you will either have to have a precision lathe if you are going to make use of the accuracy of their acme threads or you will have to print your own polymer fittings to use on unmilled ends of this stuff

I also visited another potential supplier of filament. I'm not going to mention their name yet because I haven't got firm prices out of them yet. They don't want to quote till they have some data sheets for CAPA. I'm planning on getting those out to them in a few days. I can tell you that they were talking about processing costs in the range of \$1.10/lb, though.

I feel that it will be a good idea to develop relationships with several suppliers of filament rather than dealing with one exclusively so that we will have some flexibility on delivery schedules and quantities as the demand for filament picks up in the next year or so.

More thoughts on the Mk II...

Monday, 30th October 2006 by Forrest Higgs

I've been thinking some more about the Mk II. It's a great machine, but it's a little difficult for somebody with limited skills and tools to make up a few of the parts that aren't polymer.

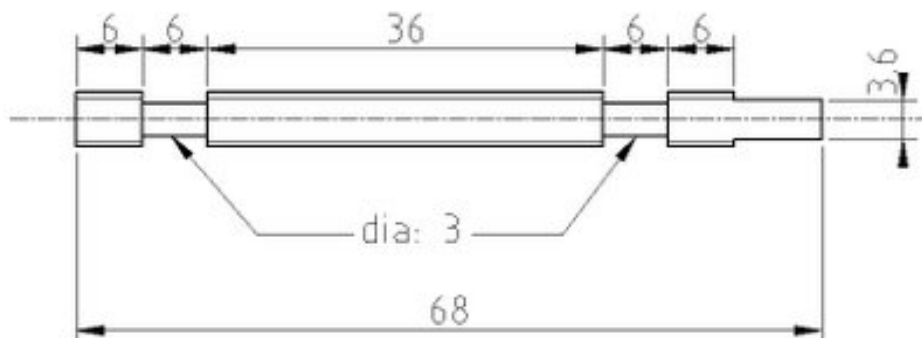

After the nozzle, the threaded polymer pump is the biggest bother. The bushings are inset from the ends of the studding which means that you have to have split bushings, which are also a pest to make.

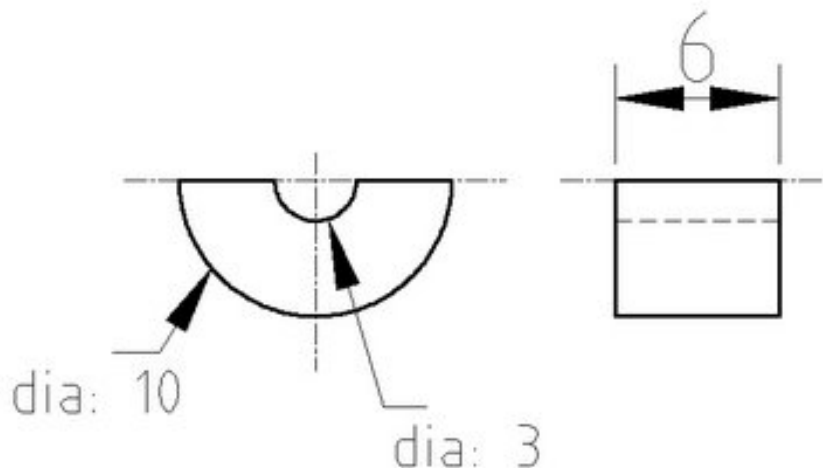

What would happen if you placed a bushing that seated at the lower end of the studding, which you'd turn down and another that slipped over the upper end as a sleeve. If you did that you could prepare the studding polymer pump in an ordinary electric drill with a metal file. You'd only have one threaded length instead of three, which would make seating bushings a lot easier.

As well, you could make the bushings out of square bar stock, probably brass. That you could secure in an ordinary vise with ease and drill with a hand-held electric drill or drill press if you had it and then saw the bushings off the bar after you'd drilled them.

It would also be nice if we shifted the drive motor over to a GM3 which has a short stub shaft coming out of the top of the gear box. That would let us install an AS5035 chip on top of the drive shaft and monitor filament feed rates and detect jams in real-time.

That takes me back to Vik's original drawing.

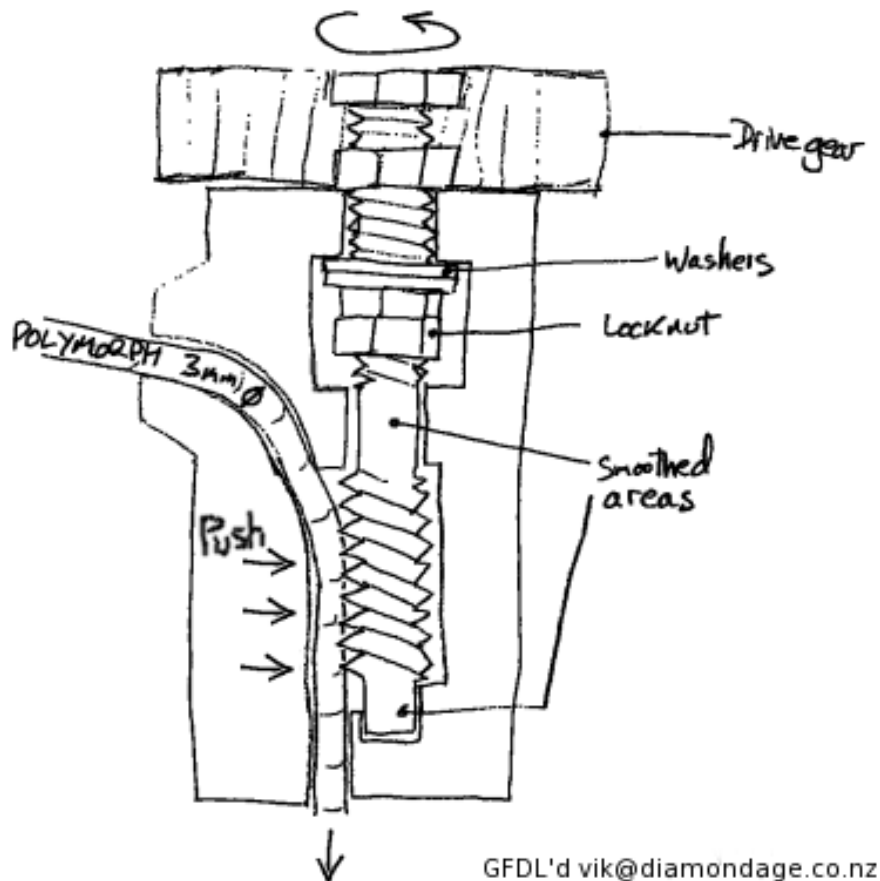

Note how Vik feeds the filament in from the side. I've wondered what is to stop us from making the pumped filament exit the pump along a radius, too. That would let us avoid the bottom bushing with the emerging filament. It would also let us put the polymer pump at a 90 degree angle or some other angle to the line of the extruder barrel. That would let us reduce the height of the overall assembly of the Mk II and make our overall machine a bit more compact and maybe use less material in the structure of the rewrap.

Comments? Ideas? Rotten tomatoes? :-D

Extruding -- or not

Thursday, 2nd November 2006 by Simon McAuliffe

So I finished building my Repstrap. See <http://repstrap.blogspot.com/> for ungainly pictures. I'm quite pleased that I managed to make it entirely from some copper tubing, an old PC and some old roller skates. A few nuts, bolts and electronics parts too of course, but all in all pretty simple.

It is using the L298N driver electronics as well now, which works much better than the others and also provides a lot more torque (and therefore also higher speeds). Which reminds me -- I must wiki that.

Everything works very nicely. I have run some test objects through it and everything is behaving as it should. My only problem is that the MkII extruder is really not extruding very quickly at all so the results are pretty hopeless. The first test extrusion was okay:



(the dodgy looking end is caused by me pulling it off the extruder)

After it gets moving it has a good 0.60mm output which is exactly what I was aiming for on this first nozzle. However it settles into a pattern of not really extruding much of anything at all. I'm guessing the M3 studding that pulls the filament downwards is stripping the filament after a while and losing its grip.

Has anybody else experienced the same problem? Is it just because I'm driving the extruder motor

too quickly? If I drive it a lot slower, does it still extrude okay (sufficient pressure, etc.)? Can I even drive it slowly enough without stalling it? How fast does the MkII really extrude when its working properly (0.6mm dia)?

Test driving the RepStrap

Saturday, 4th November 2006 by Simon McAuliffe

I tried printing a few different simple objects with a 1mm extrusion size today. Here's a two layer hexagon. It seems there are currently a few little glitches with the hatching algorithm, so it's slightly misshaped, but otherwise looking generally good. I obviously still need to tweak some of the parameters a little to eliminate the gaps.



There's still a way to go to catch up to Vik's more true-to-concept machine. Hopefully I will be able to print my own parts for Darwin soon though.

As he giveth so shall he taketh away

Sunday, 5th November 2006 by Simon McAuliffe

I toyed with a small variation in the code today. Rather than producing an object from the bottom up, I added an option that reverses this so it produces the object from the top layer downwards.

Plug a dremel onto the extruder stage, and suddenly you have a mini-mill.

Throw on a block of plaster of paris, and you can easily cut out molds:



It would be easy to add sprue-points and gates to lock positions, then you could make a double-sided mold that accurately lines up.

Pouring in something simple like molten aluminium could produce some nice metal parts.

Of course it's not the reprop way, but it's interesting nonetheless.

A Printable Penguin

Friday, 17th November 2006 by Vik Olliver

Using the 2.5mm CAPA filament that Forrest had made up, I've produced a 50mm tall penguin for my upcoming presentation at LCA 2007:



It's extruding fine, and the sparseness of the fill is intentional at this point. The deposition is done with Simon's latest version of the code that raises and lowers the head to avoid smears. It works well, but there are small drawing artifacts that cause the head to bounce up and down in the penguin's feet, causing it to look like the RepRap is trying to hammer the polymer in!

Vik :v)

Unexpected twist for new filament

Tuesday, 21st November 2006 by Forrest Higgs

As per our discussions I began breaking up the 3 kg of CAPA filament for shipment this morning. Earlier, Vik had said in correspondence that...

The new filament rotates a lot more in the extruder than the old filament. A lot more.

I left a rather large model going and went to have a shower. I came back to find filament wrapped around the support pole I use like bindweed, and the extruder was gamely trying to suck in support rod and all. I knew this would end in tears...

Vik's words came back to me in both bold face and italics when I began making the new coils of the filament for shipment. The filament has a strong memory of the roll it was put into. Left to its own devices it does its best to return to that shape regardless of what you are trying to achieve. In that it behaves a lot like military entanglement wire made of spring steel and a bit like certain garden hoses I have known. For a few moments before I was able to leverage the natural coiling of the filament I had mental images of my body being found on the floor of my flat a week hence in a big, slightly pink cocoon of the CAPA filament.

As well, the inclusions that Vik and Simon reported are definitely NOT restricted to the ends of the filament consignment but a regular feature every few feet in the filament. The inclusions are of two types. The first are friable black flecks that apparently adhered to the filament after it left the extruder before it cooled. The second are embedded inclusions that obviously got mixed in with our polymer when it was dumped into the extruder hopper. I'd suspect that either the extruder wasn't fully clean when they did our run OR that they burned a bit of the CAPA getting the settings right and that the burned flakes got included in the subsequently extruded filament.



I took a photo of the inclusions which I intend to send to Image Plastics as a starting point for a discussion on these matters. This is something that certainly wants addressing before we place a larger order with them.

I did notice that as I was unrolling the filament from the inside of the coil, which was the first filament extruded the number of inclusions in the filament declined. I did the two 2 lb rolls first and Simon's 1 lb roll last. Simon's looked much cleaner than the previous rolls. This may mean that the extruder had some junk in it which cleared as more filament was produced. I noticed this happening in the screw extruder that I built many months ago.

Modesty demands...

Tuesday, 28th November 2006 by Adrian Bowyer

...That we not tell you the following quote from Saturday's paper :

"[RepRap] has been called the invention that will bring down global capitalism, start a second industrial revolution and save the environment..." - James Randerson writing in The Guardian on November 25, 2006.

Faster, Cheaper, Better

Tuesday, 28th November 2006 by Simon McAuliffe

Wow, look what we can model:

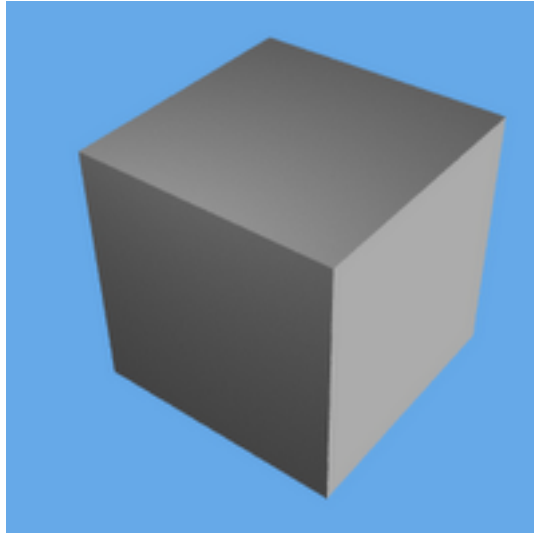

Okay, so it doesn't look very impressive.

In a small diversion from updating the comms code I wrote a plugin for Aol that does a kind of 3D tessellation or decomposition of arbitrary shaped objects, removing much of the internals of the object. It is removed in such a way that it can be fabricated additively without any support material, just by allowing for a small amount of overhang between layers. Experiments conducted earlier by Ed and Adrian suggest a 45° overhang is achievable (hence the 45° slope in the RepRap logo).

Although the end result in this case is just a cube, a cut-away view reveals the internal structure:

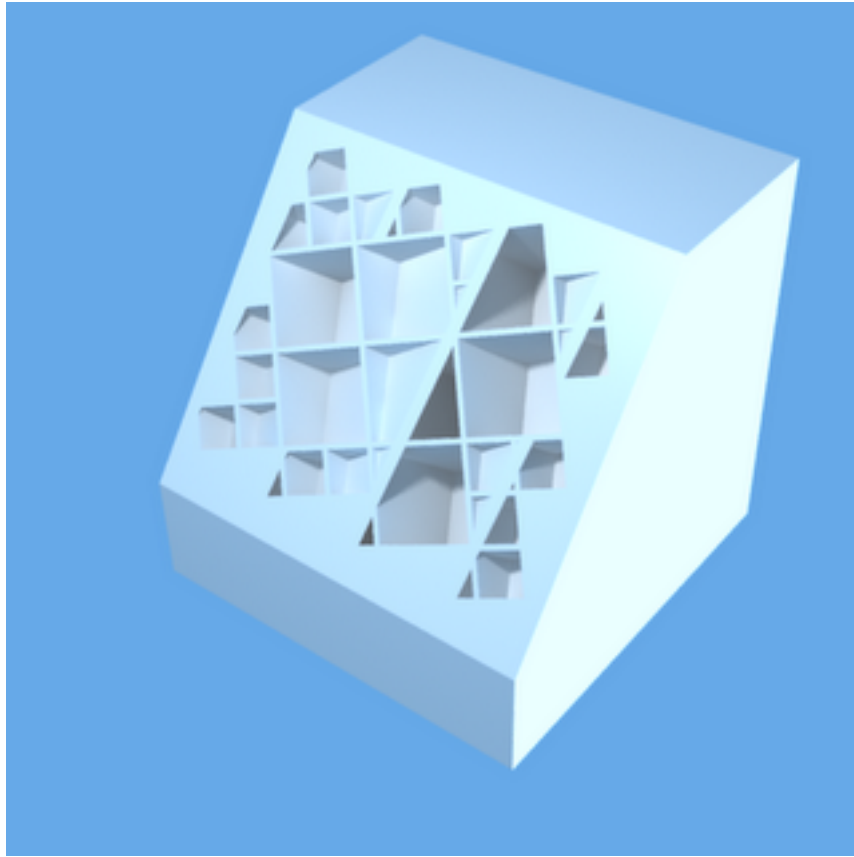

The code can be extended to arbitrary tessellation shapes, and I've implemented cubic and tetrahedral decomposition to date. The tetrahedral one really still needs some work because as I now realise, you can't completely decompose an object into tetrahedra. There are also some square dipyrramids in there too, which mess things up a little bit.

The advantage of the tetrahedral approach over the cubic is that it is a geometrically stronger shape (the cubes should naturally deform more easily, which might be useful in some situations). Also, with tetrahedra the maximum overhang angle is 30° which should be easier to achieve too.

The parameters allow for the adjustment of the minimum and maximum feature size and also the wall thickness. If chosen appropriately, the walls may end up being just a couple of straight lines from the extruder with no infill required. It will significantly speed up the process of making objects, as well as requiring less material and making lighter parts.

This is something you can really only imagine doing with an additive fabrication approach like that used in RepRap, and is potentially very powerful.

The general approach is just to fill the object with the chosen filler "crystals", starting with as large a size as possible (up to the specified maximum) and then filling around it with ever decreasing sizes, down to the minimum size specified:

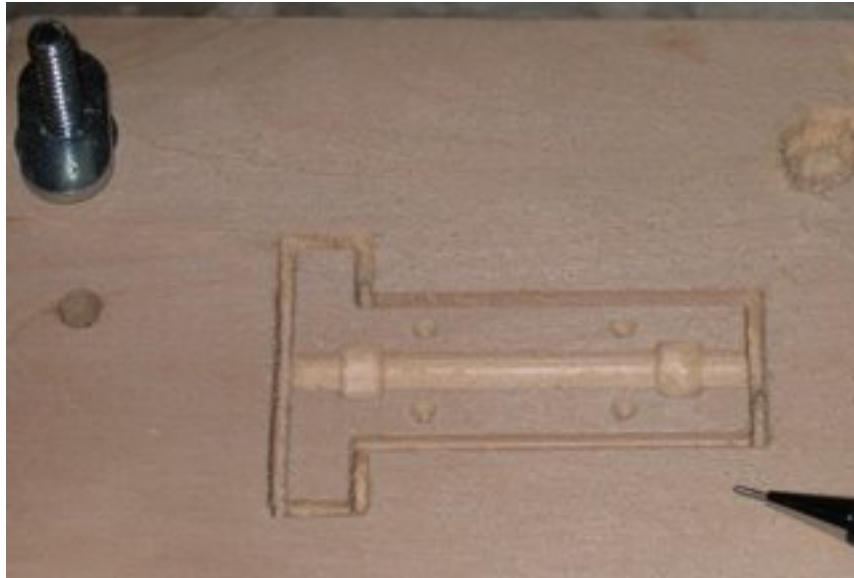

Image not found.

There are other possible approaches that may also work well, such as a tree like structure that branches ever smaller until it reaches the extremities.

Milling about.

Wednesday, 29th November 2006 by Sebastien Bailard



I hope this part doesn't look too unfamiliar. It's part of the extruder head, and here I've milling it out of wood using a CNC-converted Taig mill (aka my lazyman's off-the-shelf repstrap).

I'll write up more of it once I'm further along, but for highlights, I opened the .stl file in meshcam, a windows-based CAM program, and generated the g-code (the toolpaths). (Meshcam works ok under wine on linux, if you open the meshcam program using its entry in k-medu->wine->meshcam. (K-menu is the little menu in the corner of the screen.)) Meshcam doesn't work when you open it with wine via the terminal. It was extremely tedious figuring this out; I'm hoping I'll be able to use Neil Gershenfeld's cam.py to do the .stl-> g-code next time.

I'm using emc on a cheap used 500MHz linux box with a parallel port to do the CNC control. This involves opening the g-code file in emc and hitting "run". emc then parses the g-code and sends the right commands/5V pulses to the stepper controller circuits.

The stepper control circuits are just three breadboards hooked up to my computer via a parallel port cable. I'm using a variation on the L297/L298 reference circuits, basically this:

<http://www.pminmo.com/l297-8/l297-8.htm>

A taig mill is probably overkill for this application (milling plastic and use as a repstrap). I bought mine for USD1K+ from Nick Carter, but viewers at home could do quite well with a sherline, proxxon, or unimat, I imagine. Note that these machines don't have the horsepower of a taig; they're smaller and lighter, but fine for milling plastic and aluminum. There's a long list of suitable already cnc-converted mills here:

http://www.desktopcnc.com/hard_pg.htm

and the cheap route is to get a sub-usd\$500 chinese mill/drill

- Cummins 7877 Mini Mill
- Grizzly G8689 Mini Milling Machine
- Harbor Freight 44991 Central Machinery Mini Mill/Drill
- Homier 03947 Speedway Mini Mill
- Micro-Mark 82573 MicroLux Milling Machine

There's a good manual on these machines [here](#) : on littlemachineshop.com, and people working on these and similar projects here:

<http://www.cnczone.com/forums/forumdisplay.php?f=164>

Be warned that the build quality on the chinese mill/drills is highly variable, although reportedly is improving. If you buy one, buy it local, so that you can return it if yours happens to be broken/too much of a fixer-upper.

I'll write up a bit more once I've made more extruder parts out of UHMW plastic, and wiki-fy all this as well.

Bit of Edam

Wednesday, 29th November 2006 by eD

I've started work on an idea for corner brackets to assemble a solid frame for Darwin.

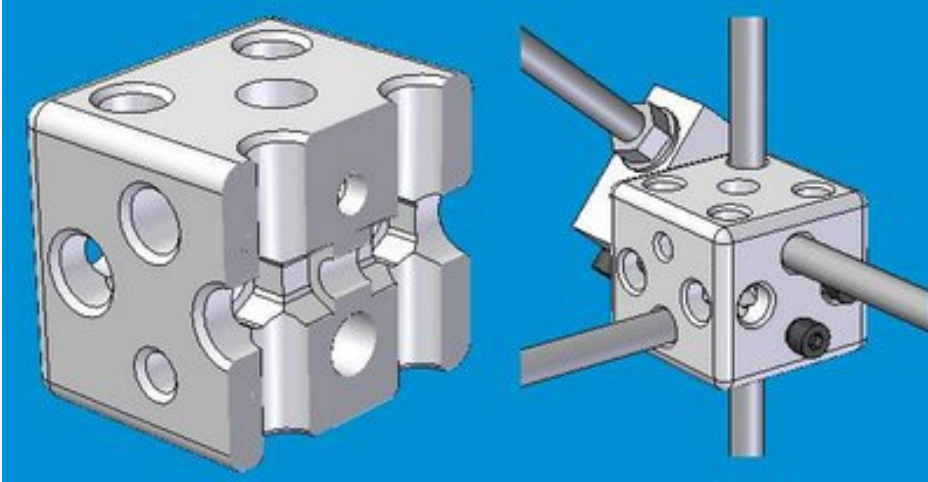

It's 45x45x40mm, symmetrical and provides 'through-hole anchorage' (i.e. the bar passes all the way through the bracket, thus rockhard clamping) for three bars and one bit of studding. Also, if the bolt configuration's right (which is a real mind-job) it also offers 2 expansion holes, 3 without the studding (I think, maybe 4).

I Aol'd it! Which is a big deal for me, as I have been hiding in my familiar Solid Edge hole for a while now, hoping no-one would notice. And it wasn't all that bad! Quite a powerful approach I thought. Though I need Vik's advice on how to do complicated sketches. I STL'd the final version and the Strat's knocking out a prototype nownow...

The design totally lends itself to Simon's magical crystallisation. How do I get that button on my screen? ;-)

Universal PCB

Wednesday, 29th November 2006 by Adrian Bowyer

And out of the bubbling ferric chloride bath comes...

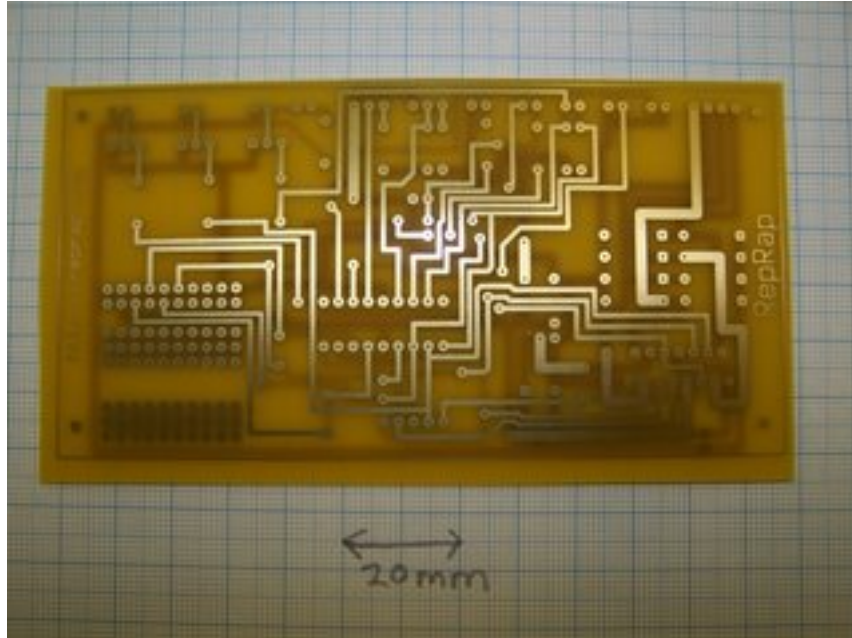

I'm working on that - a single PCB that can be populated to make either the RepRap stepper controller or the extruder controller. Here's what it looks like in Kicad:

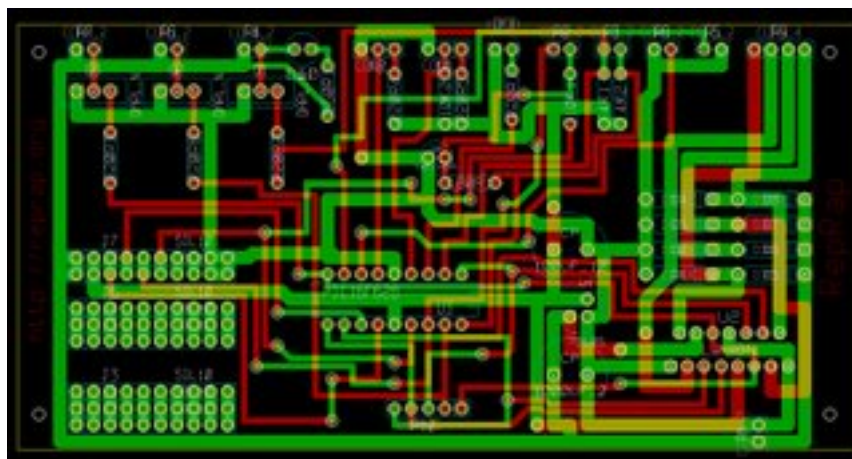

This would make constructing these a lot easier - there would only be one component instead of two, and much less soldering and opportunity to make mistakes.

Now to drill the holes, solder wires in the vias, and add chips...

If it works, it'll go on the wiki as part of the RepRap 1.0 "Darwin" design, which will be the first release.

Universal PCB test

Thursday, 30th November 2006 by Adrian Bowyer

Here is the first test of the universal PCB:



As you can see, it is not fully populated. We are trying to design RepRap so that not only can you test parts when they're finished, but so you can also test them as they're being built too.

Here I have just added the smoothing caps, the 5V reg, the PIC chip holder and the what-the-hell's-going-on? LED.

Pouring 12V into it made the LED light up, as you can see.

Better was that, when I programmed the PIC with Simon's stepper firmware then put the board in the token ring I could make the LED flash by running the RepRap Java software and asking it to move the X axis. The LEDs are supposed to flash when the motors turn, so all seems well. Now for the stepper-driver H-bridge chip...

Incidentally, the busy area bottom right is a breadboard area in which users can build their own circuitry (Vik's idea).

Universal PCB update

Sunday, 3rd December 2006 by Adrian Bowyer

I've wired the first Universal PCB I made as a stepper controller, modified the driver software so it will work both this and the old design, and fired it up with a little ex-HP-printer stepper connected as a test - seems to work.

In the University tomorrow Ed and I'll put it in ARNIE and see how hot the L298N gets (the 754410 gets jolly hot...).

Lost units

Tuesday, 12th December 2006 by eD

This post is to ask you, the RepRap community what parts are readily available:

In 1824 we, the Brits, came up with the Imperial measurement system and in keeping with the times, spread it around a bit. In 1995 we officially became an SI nation and now I, fully metricated, have no clue what the imperial spread is...

Thanks to Vik's suggestion I'm trying to make my corner block (see previous post) fully compatible with both units. The closest bits I've found to my 8 rods and M5 nut/bolts are: 5/16" bar and 3/16" whitworth (?) nut and bolt combo... so how easy are these for you guys to get hold of?

Hiccup

Saturday, 16th December 2006 by Adrian Bowyer

Sorry - Bath Univ. has gone offline for the weekend - some big upgrade. This means that the redirection of rerap.org will be a bit dodgy for a couple of days. Shouldn't happen again.

Experimental gear train

Tuesday, 2nd January 2007 by Vik Olliver

Happy New Year!



I've printed out a couple of polycaprolactone gears and an impromptu plate to hold them in place. We're laying down about 4cc of polymer/hr using the 2.5mm filament that Forrest sent me. I've upgraded my Mk2 extruder to Adrian's revision with the 2.5mm holder. Probably needs more calibrating but goes for now.

Here is a 2M MPEG video of the gears meshing taken using my decent Sony cam and a tripod.

The "Darwin" design doesn't use gears per se., but as they're bound to be desired in some mechanisms I thought I'd print them out as a learning exercise. The teeth do distort as they get higher, something that thinner layers or an improved deposition algorithm may solve.

Vik :v)

Java anyone?

Friday, 5th January 2007 by Forrest Higgs

I was working with the slice and dice code that generates extruder tracking instructions for Tommelise when I ran across what may well be a problem of interest to the mainstream development community as well. When I sized a 13 toothed gear on a mm scale, this is what I got.

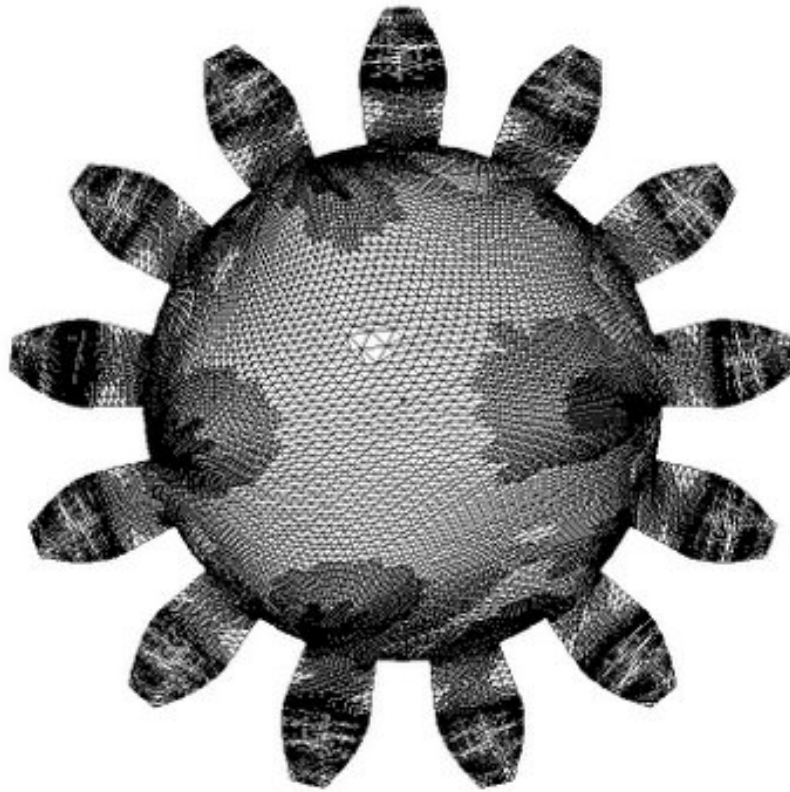

When I extruded it and exported it as an STL it took 44 megs and had over 100,000 facets (my programme crashed at that point). I then reduced the scale to cm and got this.

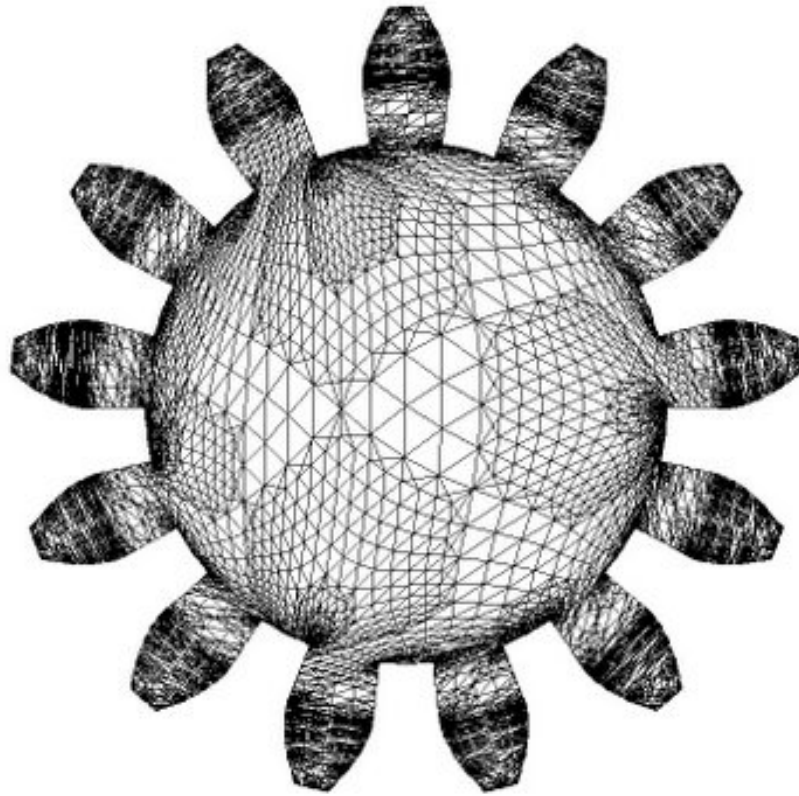

Which, when extruded and rotated looked like this.

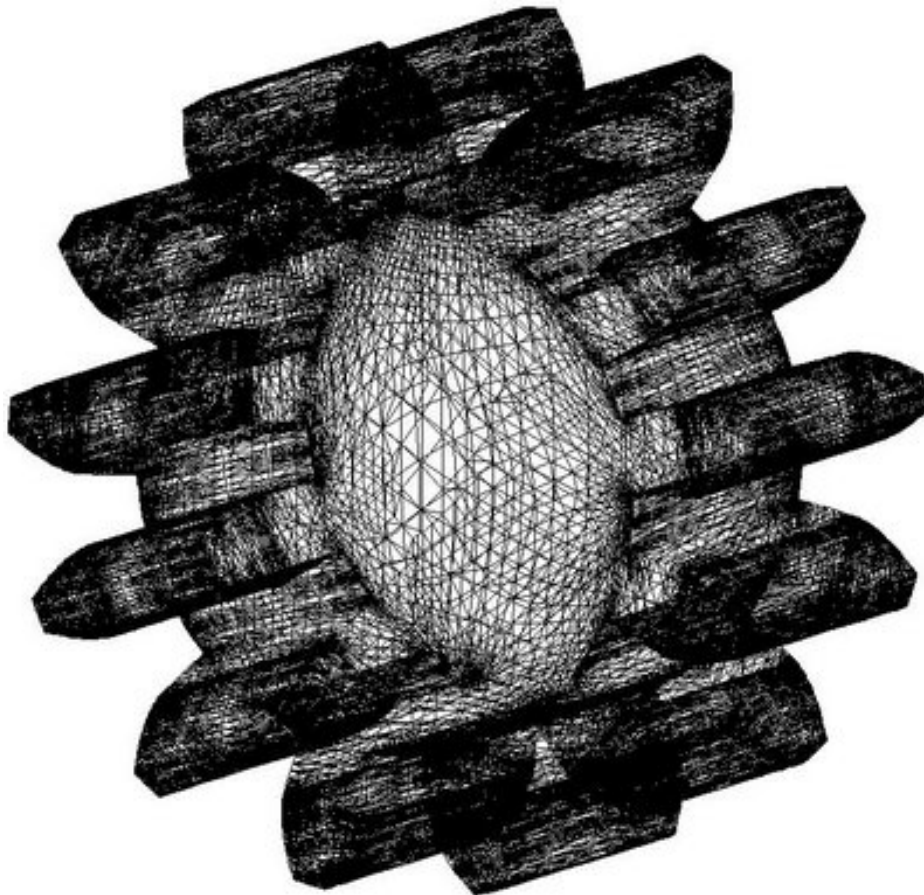

That little monster had just over 71,000 facets.

Is it just my imagination or could we use a triangle mesh routine that is a little brighter, or perhaps we ought to extend the gear routine to generate itself as an importable OBJ file and mesh it ourselves.

Is this worth doing? Is anybody up to taking on such a Java challenge?

Cheers!

Saturday, 6th January 2007 by Vik Olliver

"To the RepRap!" That's my toast, made with a very small fabricated shot-glass. The shape is vaguely reminiscent of a leather tankard, and its dimensions are 25mm dia. (average as it deliberately tapers), 2.3mm walls, 21mm high. Production took 5725 seconds (95 minutes) and used a notional 3cc of polymer. Oh, and it is watertight (even holds schnapps for a while). The "bubble" around the deposition head is the neck off a plastic drink bottle and keeps the cooling air off the head.



I claim first RepRap'd utilitarian object!

Seriously though, if we can manufacture watertight containers, we're not too far off making bioreactors and some medical equipment.

This was the second attempt. On the first, the swivel on my feeder bottle (see below) became stuck, and the filament wouldn't de-kink. This slows the passage of the filament down, and the output thins out to nothing over a couple of layers. I now have two swivels on the feeder bottle, and I've replaced the croc lead with an old MP3 player strap.

Vik :v)

Filament supply line & belt drives

Saturday, 6th January 2007 by Vik Olliver

A double one for you. I've fixed the problem of twisting filament supply by just stuffing the filament into a 3l juice bottle. It self-organises inside, though there are probably more optimal configurations :)



The bottle is attached with a bulldog clip and screw-in swivel. This then goes by a spare croc clip lead (what? what? Look, it was the first thing to hand...) to a clamp on the ceiling. Saves making a hole and upsetting Suz. There is a surprisingly large effect on the throughput of the extruder if you don't allow the feedstock to unkink. It becomes much slower and the output fades out.

The second thing is a belt drive gear. I put a joined strip of belt into a lid and pummelled in polymorph with a battery (flat, round, right size, to hand). This moulded one gearwheel that fits the belt perfectly. The impression of the gap had to be trimmed, re-melted, and run over with a belt a few times, but it went smoothly in the end.



On the right side are a number of gears made at different deposition speeds and layer thicknesses.

Vik :v)

Darwin's first cut

Monday, 8th January 2007 by eD

Sorry for the delay, our broadband cable had a run in with a hedge cutter. Here's the first cut at Darwin. A nod to Simon as it's come out pretty close to his RepStrap! I've tried to export it as VRML but Solid Edge won't export it for some reason (might be an academic licence thing) - if there's any backdoors to sharing this virtually I'm all ears. Hopefully there'll be some shots of it in the real world soon...

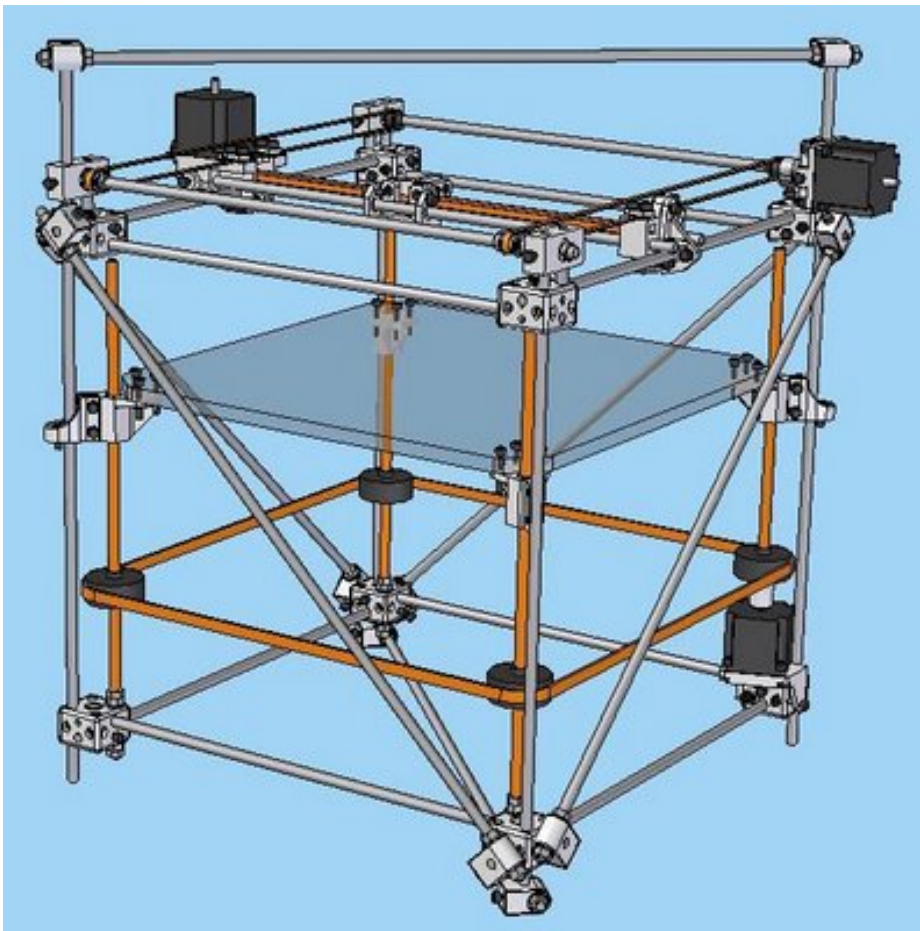

Support material

Thursday, 11th January 2007 by Adrian Bowyer

I had a sudden thought about support material (apologies if someone already suggested this and I've forgotten...).

Why don't we just run a 3mm rod of PVA through the Mk II extruder? The partially hydrolysed stuff has a low melting point and is water soluble (especially if you deposit it with small gaps to allow water ingress). Two birds - one stone...

See [this DC Chemicals site](#).

More on PVA as a support

Saturday, 13th January 2007 by Adrian Bowyer

I did an experiment. Apparently glycerine is the stuff to use as a plasticiser with polyvinyl alcohol (PVA), so I weighed out four samples of Evo Stick wood glue (which, as far as I can tell, is just PVA dissolved in water), added different weights of glycerine, and let them set. They didn't, so I put them on a 60 °C hotplate to evaporate the water.

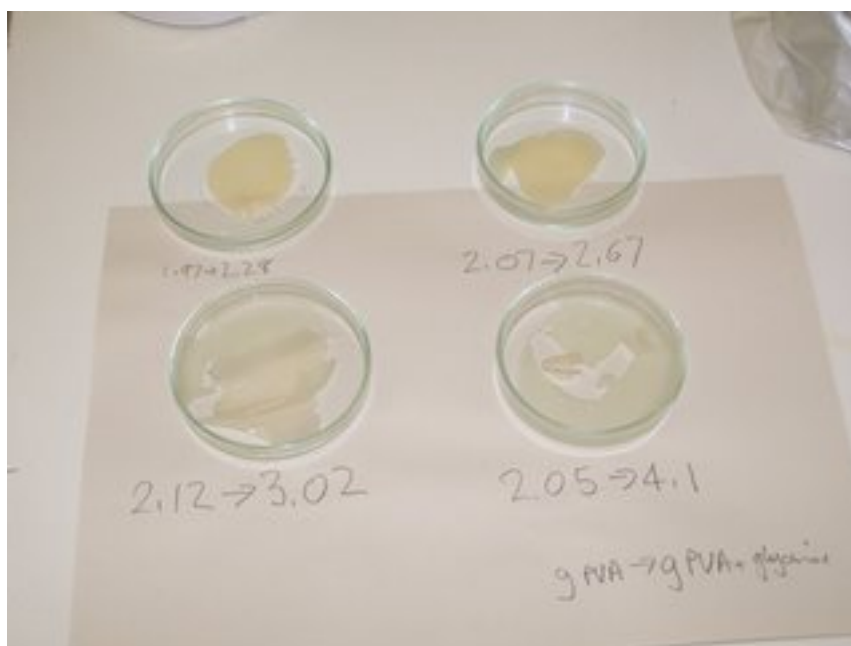

The left hand numbers are the weight of PVA from the glue tube, the right are the weights after the glycerine was added.

Result: it's really easy to control the mechanical properties of PVA by adding glycerine through from brittle (top left) to a pretty solid gel (bottom right). The consistency that seems about right for feeding through the Mk II Extruder is the top right one, which is about 20% by weight of glycerine to Evo Stick (a number that doesn't make much sense as it stands because of the original water, but if I add that the dry weight is 1.47g that means there's 0.6g of glycerine and 0.87 of PVA).

I have no way of telling the degree of hydrolysis of the PVA in the glue, of course. For low melting point we need that to be low. But I put a piece of my glycerined PVA on a piece of aluminium foil on a hotplate next to a similar piece of polycaprolactone. I prodded them as the hotplate warmed up. They both melted at about the same temperature, and exhibited about the same sticky consistency.

Now to see if I can cast a 3mm rod of the stuff...

Reference: *Plasticizer effect on the melting and crystallization behavior of polyvinyl alcohol*
Jyongsik Jang and Dong Kweon Lee

RepRap at Linuxconf Australia 2007

Wednesday, 17th January 2007 by Vik Olliver

For those lucky enough to be at the Sydney LinuxConf (follow link or google for "best linux conference") RepRap is being presented on Wednesday at 4pm in Mathews A.

For those not there, but are nearby, RepRap will be at the LinuxConf Open Day on Thursday.

Just a note for the confused: RepRap is not exclusively for Linux, it's just that Linux is a very convenient development environment that fits the Open philosophy of RepRap. Basically, it lets us give the whole development kit away for free including the operating system.

Video of the presentation is now available here.

Vik :v)

RepRap 1.0 "Darwin" Communications and Power Distribution

Tuesday, 23rd January 2007 by Adrian Bowyer

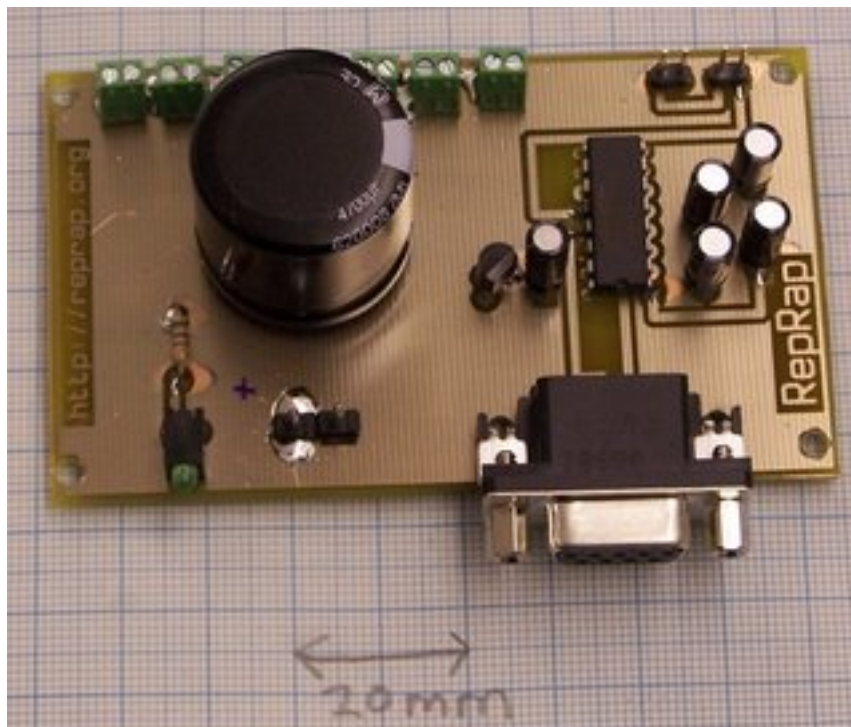

The communications and power distribution board for Darwin (above) is now finished and tested. Details can be found [here](#).

This means that the design for all the electronics for the machine has been finished except for the opto-interrupter end-stop for the axes (which will just consist of a slotted opto-switch and two resistors, so it shouldn't take long).

All the designs are in the RepRap subversion repository [here](#).

Mk 2 Extruder part made on Zaphod

Monday, 29th January 2007 by Vik Olliver

Last night I left Zaphod printing out a slightly modified poly-holder part for a Mk2 Extruder. This morning it had finished - 7 hours of printing. Sadly, a software bug means that the vertical holes are filled in in some places, but I've drilled those out so I can test the part. As the holes were mostly there, and quite visible on the underside of the part, this was very easy to do.

Here's a shot from the top, showing the new part on the right, and a similar part that came out of the Stratasys on the left:

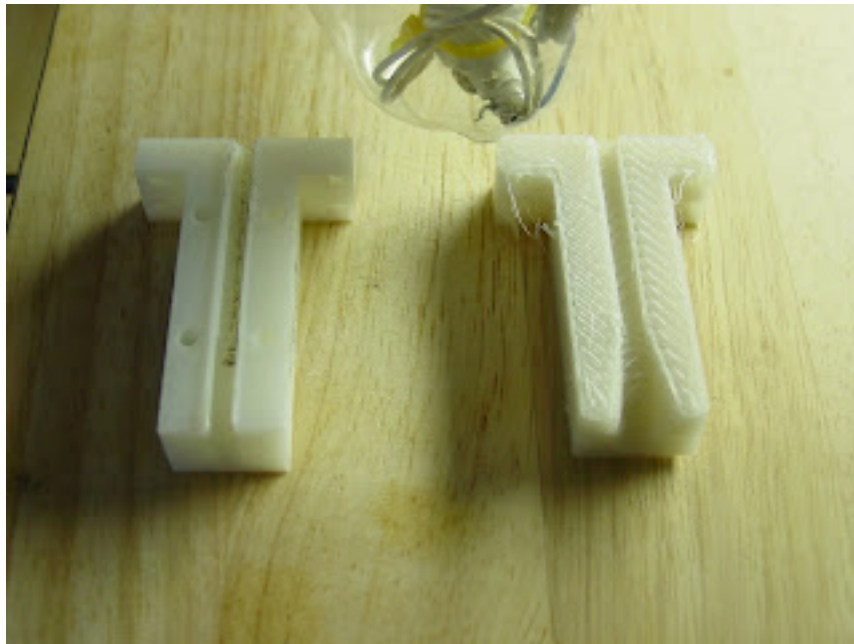

Below is a photo of the part viewed from the attachment end. Looks like I should be able to get an M3 bolt in those holes without trimming or drilling:

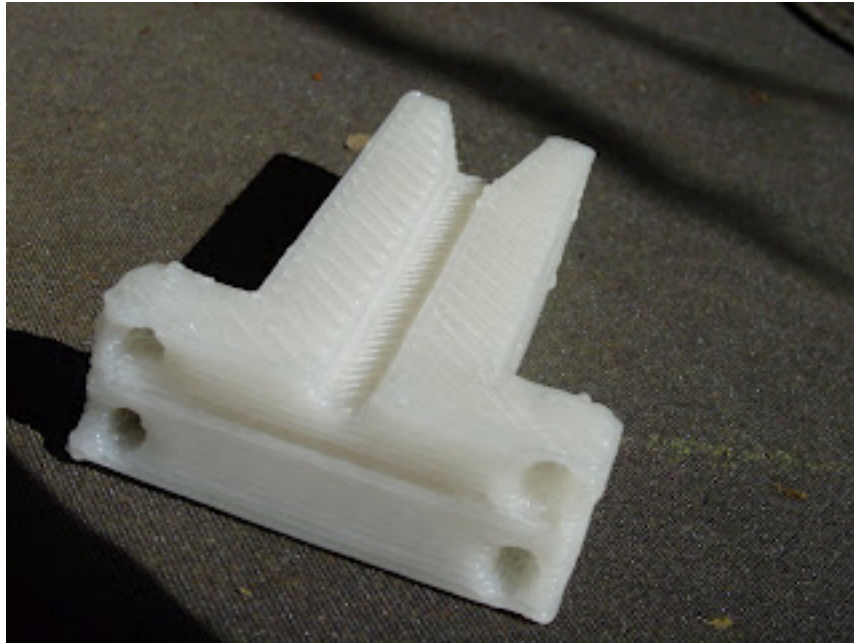

The horizontal line across the face here is where the head skipped printing a line. It does this sometimes - not figured out why yet. The lines show up in the GUI, but it's not that fatal and the objects generally recover (hopefully I will too - not feeling at best this morning).

Here's a shot of the GUI after the poly-holder had finished printing:

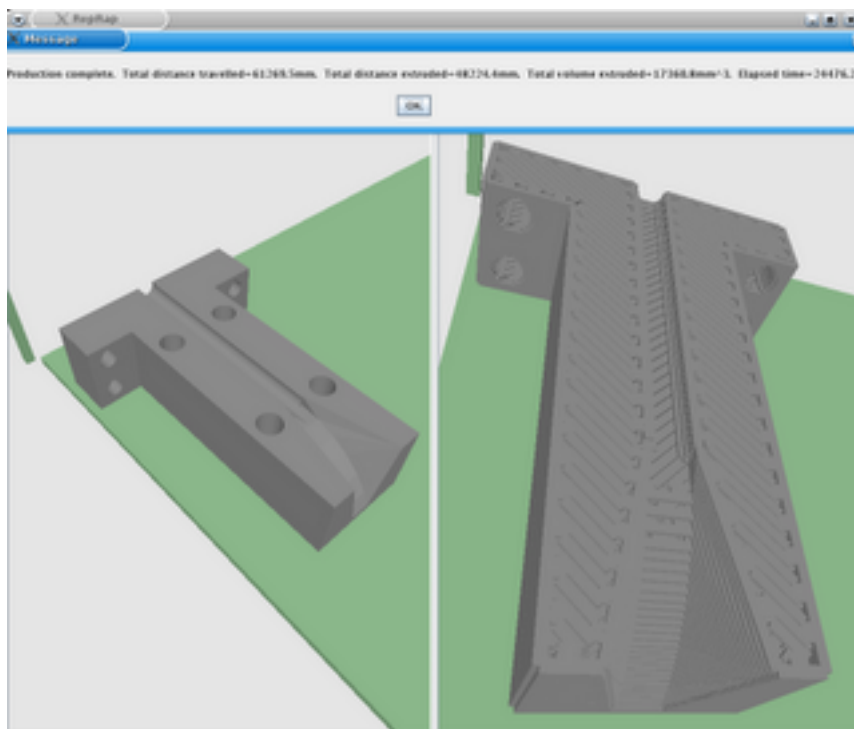

Once the hole-filling software bug is sorted, I'll print one for 2.5mm filament. Meanwhile I have some hand-rolled 3mm luminous polymorph...

Vik :v)

Now a motor-holder part

Tuesday, 30th January 2007 by Vik Olliver

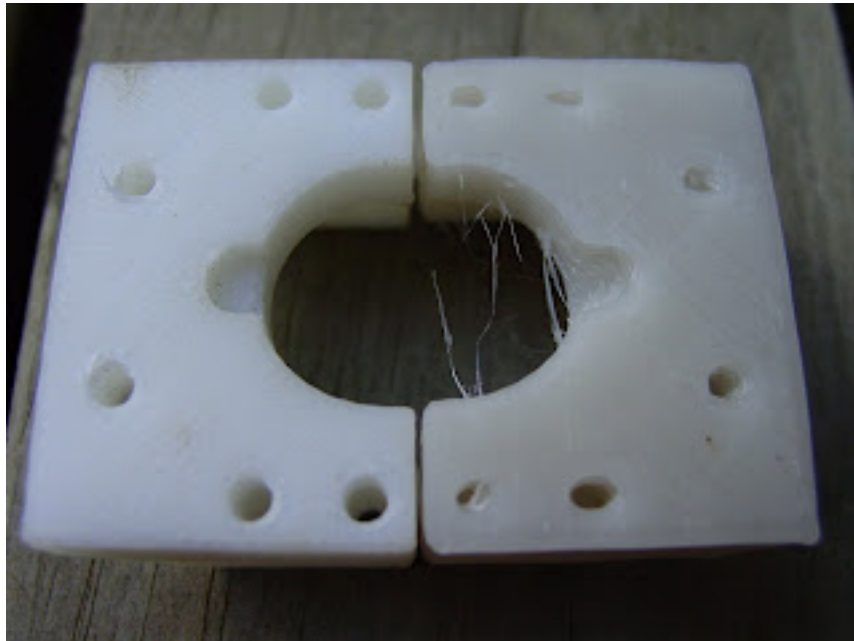

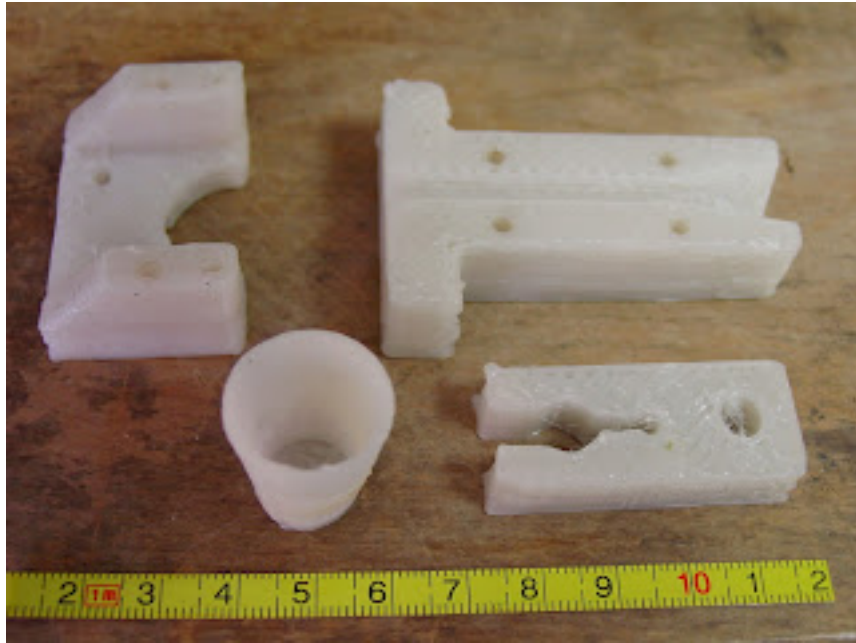

Getting better at this...

A.R.N.I.E. gives it a shot...

Friday, 2nd February 2007 by Adrian Bowyer



Ed's A.R.N.I.E. RepRap design is now fully functioning. In keeping with long-established RepRap tradition, the first object we made was Vik's shot glass to toast our success. Celebrations continued into the night, with Christine B. switching to an Irish dram...

As you can see, while we were concentrating on the build parameters, Tux (on the Strat in the middle) had already spotted the bottle...

Moulding gears

Thursday, 8th February 2007 by eD

I've been trying to further Viks fantastic idea of moulding gears using the tread of a toothed belt as the mould. I'm trying to include a concentric central hole, and a rim on one side to locate the belt.

To do this I'm using two split halves I made on the Strat - these locate on each other and are pulled together on a central M8 thread which force the polymorph into the mould's nether regions. You can see an excessive number of bolts on each half to eject the job from the mould when it's set - this is due to my paranoia of the job sticking against the rough-ish surface of the RP mould. Adrian's excellent suggestion of using a thin layer of plazzy bag on the top and bottom faces of the mould drastically reduce stickage, and so only a few bolts would be needed on a Mk2.

Results to come...

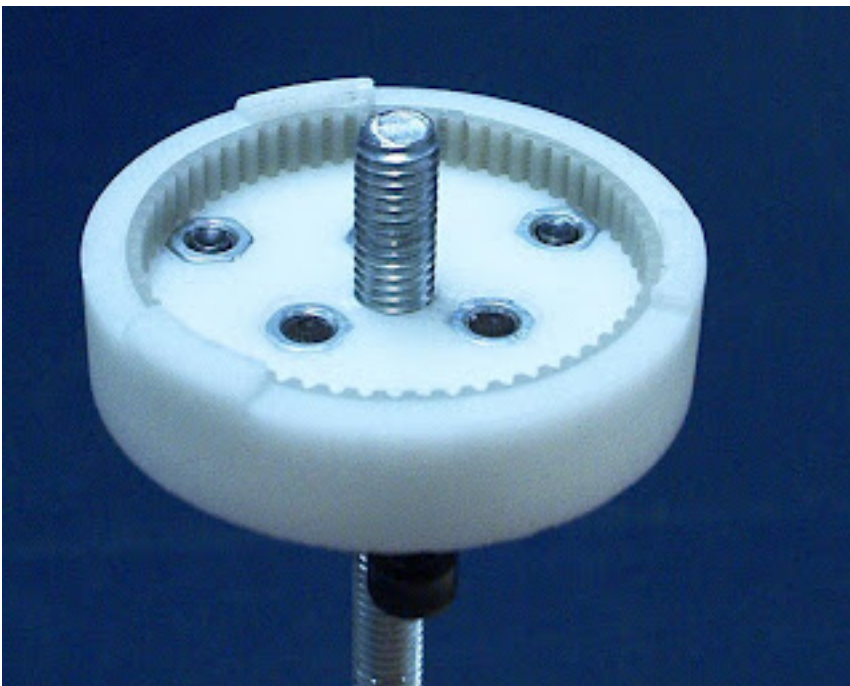



RepRapped extruder parts

Friday, 9th February 2007 by Vik Olliver

I've finally managed to run off a complete set of parts for the screw section of the extruder - clamp still to come. The screw holder itself took me 6 goes to get right (at least we know the extruder can generate a lot of output), with various hardware and software issues being resolved along the way. Printing the clamp requires the current release of Adrian's software, so I'll be upgrading soon.

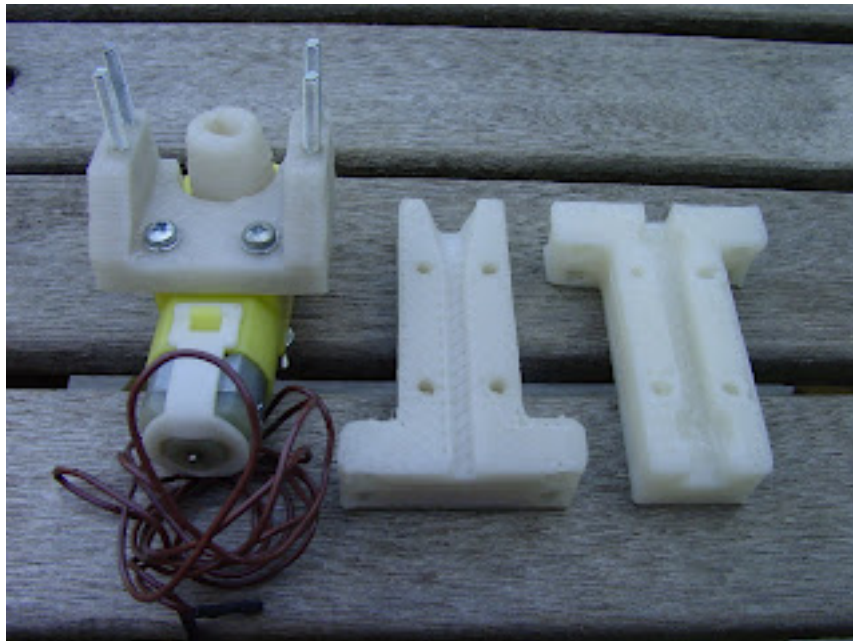

So now I need to make a new screw drive, bearings and extruder tip!

Vik :v)

CAPA Extruder Pushes Filament

Sunday, 11th February 2007 by Vik Olliver

One video of the completed CAPA extruder screw mechanism extruding a 3mm CAPA filament:

I'll add the clamp and hot nozzle later (waiting on some PTFE rod for that).

Vik :v)

Extruding HDPE in the Mk 2.1

Saturday, 17th February 2007 by Forrest Higgs

Just a note in passing. I've tweaked the Mk 2.1 for use with HDPE. It is currently extruding HDPE at a rate of just a shade over 4 mm/sec through a 0.5 mm extruder orifice with the extruder heater consuming 2 amps at 12.34v. The thread expands to about 0.75 mm after leaving the orifice.

I'm using the gearmotor in pseudostepping mode with an 80 msec power pulse followed by 160 msec pause.

It's important to remember with the Mk 2.1 that all of the spring loading on the filament must be put on the top two springs. Tightening the bottom two, something I intuitively do which is dead wrong, stops the flow.

I took a video of the extruder operating and put it on YouTube.

It's a little difficult to see the HDPE coming out of the Mk 2.1 in this YouTube video in that the molten plastic is transparent. About the height of the cardboard covered work surface, however, it cools off enough to go opaque which lets you see it being laid down.

One little note, that loop of cooling HDPE that you see is being laid down in mid-air. The filament leaned against the edge of the xy positioning table and then just started coiling up in the air about an inch above the level of the cardboard.

Pressing Belt Gears

Saturday, 17th February 2007 by Vik Olliver

I've pressed 2 sets of belt gears for Darwin using my acrylic moulds. There are 4 sheets of acrylic with alignment holes (the 4 little bolts go in them). Sheets 1 & 4 have 8mm holes in the middle, sheets 2&3 45mm holes. A piece of belt goes around the hole in sheets 2&3 to put teeth on the edge, exactly as per the rig that Ed made. PVC food wrap stops the CAPA sticking to sheets 1 & 4. The trick is not to press too hard or you open up a gap where your belt joins into a loop.



They need a little trimming, but a sturdy pair of scissors does that just fine. Better than a craft knife.



Zach is kindly documenting the process here.

Vik :v)

Website Architecture Changes

Thursday, 22nd February 2007 by Zach Smith

Recently, we've made some changes to our setup on the web here. You may or may have not noticed, but we are now serving the vast majority of our stuff off the rerap.org domain. Recent changes include moving the forums, blogs, objects wiki, and mailing lists to rerap.org. Here are the new url's for those sites.

Forums - forums.rerap.org

Main Blog - blog.rerap.org

RepRappers Blog - builders.rerap.org

Objects Wiki - objects.rerap.org

Mailing Lists - raprap.org/mailman/listinfo

The forums are an especially new addition, and we hope you come in and chat with us. We've got alot of interesting topics going and you can even follow the developers mailing list as its mirrored there.

Low-melting-point alloys

Sunday, 25th February 2007 by Adrian Bowyer

We've talked for some time about using low-melting point alloys like Wood's metal (65°C) and Field's metal (40°C) in a RepRapwrite head to allow us to build electrical circuitry, and such a system is being planned for RepRap2.0 "Mendel". We have also talked of trying them in exactly the same extrude head that we use for polymers, for which we'd need them in the form of a 3mm rod.

I've always thought that the problem with this might be that the (admittedly small) melt cavity inside the head would simply drain out the bottom uncontrollably.

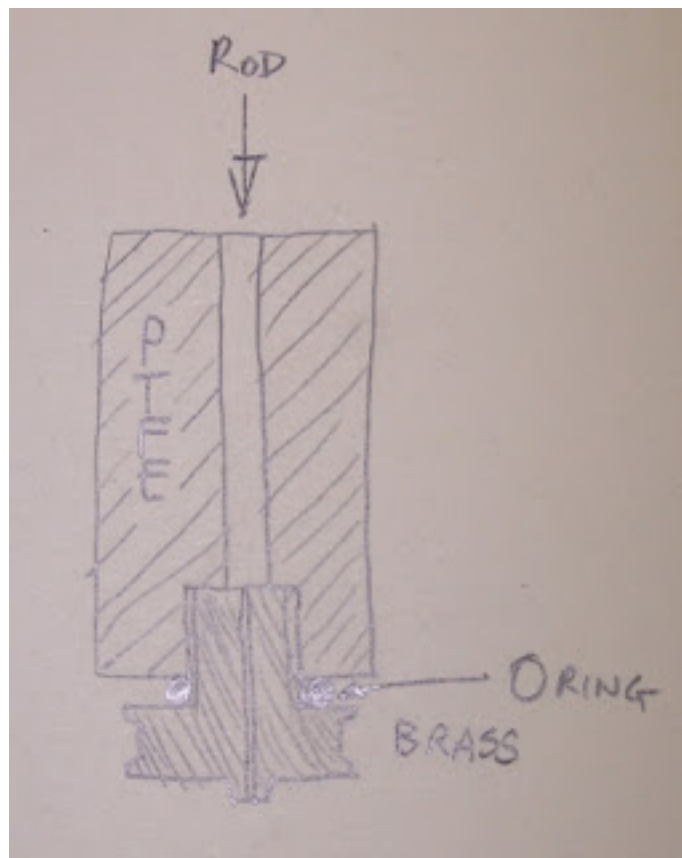

But the other day my student who's working on this, Mike Samuel, had a brilliant idea: why not replace the cavity with a small heated button with a fine extrusion hole through it, then just touch the metal on the back when you want it to melt and extrude? The extrusion system already has a mechanism to back the rod off; this would remove it from the hot-spot and stop the flow.

The head would be like the above. The brass part would have a heating coil, like the ordinary extruder, and a thermistor to measure its temperature. The Wood's metal rod would be fed into the top by the existing transport mechanism that's used for the 3 mm polymer rod we use. And all this

would use exactly the same electronics and software to drive it that we already have.

So I tried to make some 3 mm Wood's metal rod.

My first experiment was rubbish: I had a small crucible with a 3mm hole in the bottom heated by a soldering iron. The hole led through an insulating block with a 3 mm hole to a cooled section with another 3mm hole, where I thought the metal would solidify and be able to be pulled through - pulltrusion, as it's called. The whole thing locked up frozen solid, and nothing would move anywhere.

Then I looked at the silicone tubes I was using to carry the cooling water. Dang me if they weren't 3mm internal diameter. I put one on a funnel with a clothes-peg at the other end, heated them all in a beaker of boiling water, took them out and quickly hung them up, then poured in the Wood's metal:

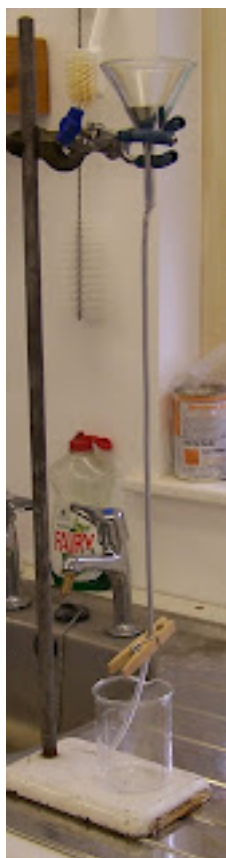

After it had cooled I just sliced away the silicone tube with a scalpel, which left a perfect shiny rod:

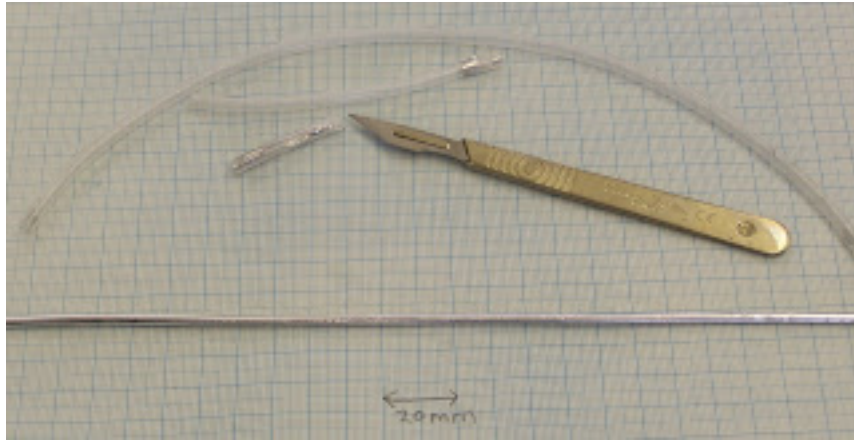

I measured it: 2.95 mm, all the way down :-))

Paste extruder

Monday, 26th February 2007 by Adrian Bowyer

I have been working in the background on a paste-extruder for RepRap that is as simple as I can make it. It's based on an idea of Zach's and Forrest's.

It's just passed its first test:

(Slightly surreally, the sound track consists of a musical biography on Radio 3; I was listening, and forgot to turn it off...)

It consists of a 500ml fizzy drink bottle containing a balloon that in turn contains the paste. You blow air into the bottle to pressurise it via a one-way valve, and the pressure then forces out the paste. It goes through a silicone rubber tube that is clamped off by a latching solenoid. Pulse the current one way and it turns on; pulse it the other and it turns off.

Of course I'd rather have used a condom than a balloon, just for max. cred., but they're the wrong size...

Here's a high-res still.



And here's a detail of the valve at A:

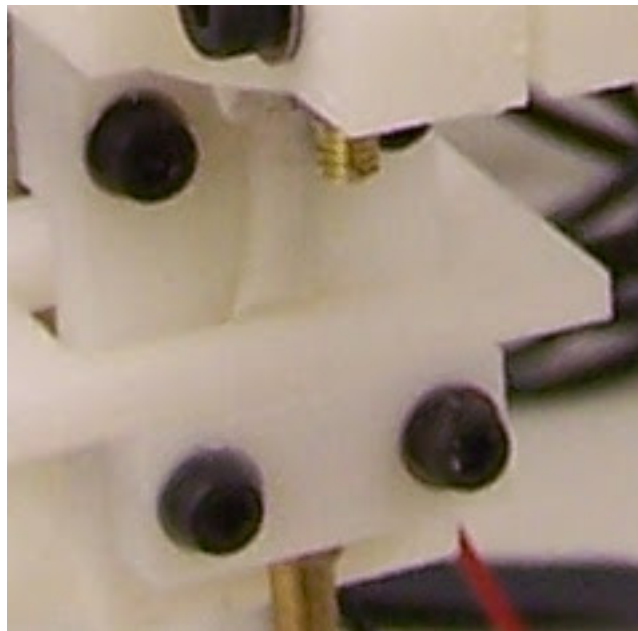

The paste being used here is Fine Surface Polyfilla, as proposed as a RepRap material by my student James Low last year. One small advantage that this stuff has is that leaks tend to seal themselves...

Printing with conventional solder

Monday, 26th February 2007 by Forrest Higgs

I gave the extruding solder thing another go before it got too late. This time I tried to lay down a track with a HDPE surface within a millimeter of the extruder head. Keep in mind that I was pumping the solder with one hand and moving the sherbet lid (my HDPE surface) with the other.

Still, I did get one reasonable trace (circled in red)



There was enough energy in the solder trace to etch it into the HDPE to a point where it is solidly attached to the plastic surface. When I say solidly, I mean that I can't peel it off with my fingernails.

If I get time in the morning I'm headed down to the hardware store to see if they have electrician's solder (as opposed to electronics solder) in a diameter something like 3 mm.

Printing circuitry in the low-rent district

Monday, 26th February 2007 by Forrest Higgs

I'm always inspired by Adrian's groundbreaking work. I guess I must see things with different eyes, though. I read his blog entry on working with low temperature eutectic alloys in the a little while ago. It seemed to me he'd gone to heroic lengths to make what was, for practical purposes, a piece of 3 mm solder. Mind, being Wood's metal it's solder that will melt in a hot cup of coffee, but it's solder all the same.

His saying that he's wanted a filament that he could run through a Mk 2 FDM extruder put me on the hunt, I guess.

You see, I know that my low thermal inertia 2 amp extruder barrel is hitting somewhere around 190-210 degrees C (374-410 degrees F). I keep several diameters of solder. In regular acid core lead I keep heavy (1.27 mm) and fine (0.9 mm). Recently, I've been experimenting with a RoHS (no lead) compliant acid core solder in a fine grade.

Knowing how hot my extruder barrel gets I began to wonder whether I could get it to melt in my extruder barrel. Problem was my extruder barrel is 3 mm while my solder is 1.27 mm. As well, if I got it wrong it would be likely that I would jam the barrel.

Then I got to thinking about the old 1 amp prototype extruder barrel that I'd built and tested back in late December and early January. Naah, it'd never get warm enough. On the other hand if it jammed I hadn't really lost anything.

So, one thing leading to another I cut off a couple of inches of the heavy grade Sn63/Pb37 solder and folded it into a plug and stuffed it in the test extruder barrel which I'd locked into my vice and fired it up. I had a short length of 3 mm HPP to use as a piston so I was good to go. The test extruder had a plug of either ABS or HPP in the end from the last time I used it, so after the barrel heated up I inserted the HPP filament and began to feed it into the cold end (~70-80 degrees C) of the extruder barrel with a pair of pliers so that I wouldn't risk burning myself however slightly.



After the plastic plug melted and began to clear as I fed the HPP filament into the extruder I began to see droplets of solder coming out with the HPP as you can see here.



After a few seconds of transition between plastic and solder the rest of the plug came out in a rush and fell into the HDPE sherbet container I'd thoughtfully placed under the extruder barrel to keep things off of the carpet. The HDPE surface that they hit was relatively rough and the acid core solder adhered to them slightly.

Here was what was important though. The specific heat of metals is, on average, about 10% of

that of organic materials like plastic. What that means is that dropping small amounts of something like solder on a plastic surface usually doesn't melt the plastic surface significantly in spite of the fact that the molten solder is far hotter than the melting point of the plastic. The plastic simply absorbs the heat like a sponge and chills the solder instantly.

Here is a closeup of one of the solder splashes that I peeled off of the HDPE surface laid on the tempered glass xy working plane of Tommelise.



I got my micrometer out and measured it at a very consistent 0.1 mm in thickness. Basically, I had a very nice piece of tin-lead foil for my troubles.

I repeated the experiment with the RoHS solder.

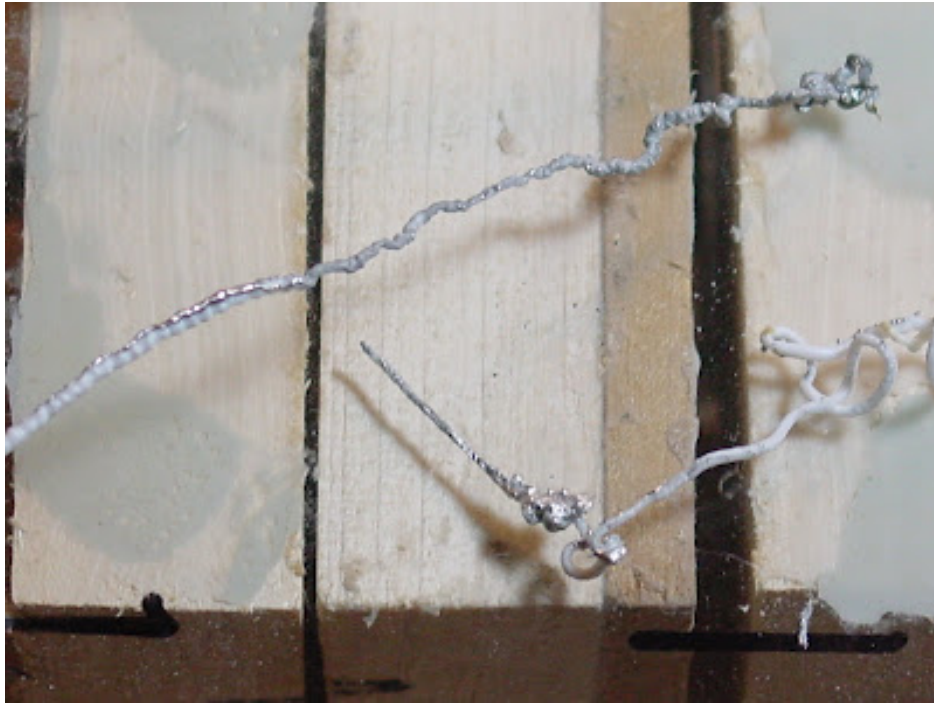

It behaved very differently. It came out in tiny beads with the HPP and in a few cases coated or partially coated the HPP. The two long threads of solder shown here at the center and left of the pic are actually electrically conductive wires made of RoHS solder. RoHS is going to take some more thinking about.

I guess I'll have to head down to the hardware store and see if I can find some hard copper tubing that can seat 1.27 mm acid core solder. I wonder if I can talk Adrian into printing me up a Mk 2 parts kit that can handle 1.27 mm solder. It would be interesting to see if I could print an HDPE blank and then print the traces for a Tommelise microcontroller board in solder on it. :-D

Shameless publicity and cash seeking

Saturday, 3rd March 2007 by Adrian Bowyer



All you RepRap fans out there may care to improve the profits of your laundry of choice (and to help RepRap along) by buying a RepRap T-shirt plus a RepRap mug so you can spill coffee down it. Visit

<http://www.cafepress.com/reprap>

for details. There's also a link from the RepRap pages.

PowerComms Board v1.1

Sunday, 4th March 2007 by Zach Smith

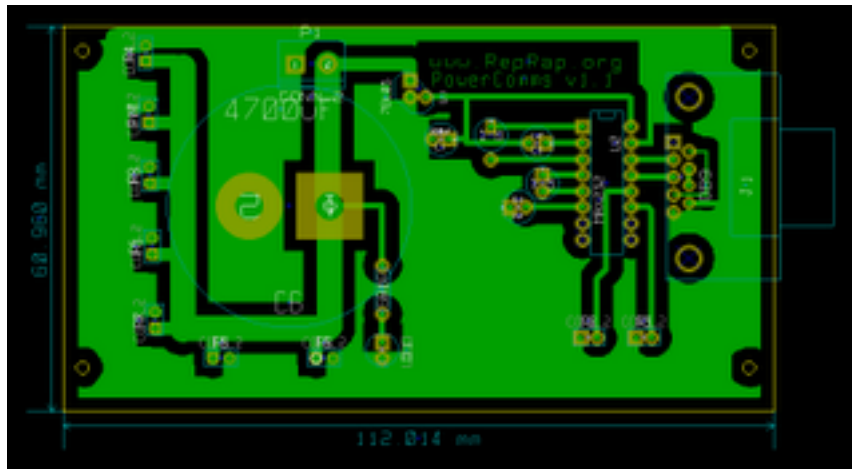

We've updated the design on the Power and Communications board. The parts are all the same, but now its a one sided board, and much easier to fabricate. All the files have been added to subversion, and the [wiki entry](#) will be updated with new pictures later this week once I actually make one.

In the meantime, here is a shot of the schematic from Kicad:

Changes

- single sided. makes it much easier to fabricate, and cheaper too. (no more alignment issues)
- fatter tracks on power circuits
- component silkscreen included for easier reference.

CAPA vs. ABS bodies extruders

Sunday, 4th March 2007 by Vik Olliver

I've hit a temporary snag with the PC software, so I'm going for the firmware while fixes happen by magic. Well, sweat & swears - er - tears from Simon and Adrian, I suspect, but let me carry on in ignorant bliss...

I've noticed that my half-washer bearings slip a bit (crappy job of smoothing the lands on the screw, I suspect), so I've packed a little bit of CAPA on top of them. This prevents exposed sharp edges engaging with the filament from dragging things around. In short, it stops your half-washers from popping out. I hope. Here's an old ABS one compared to the freshly-minted CAPA part. The CAPA part is the one on the left. The slightly fuzzy appearance of the bearing is due to Vaseline.

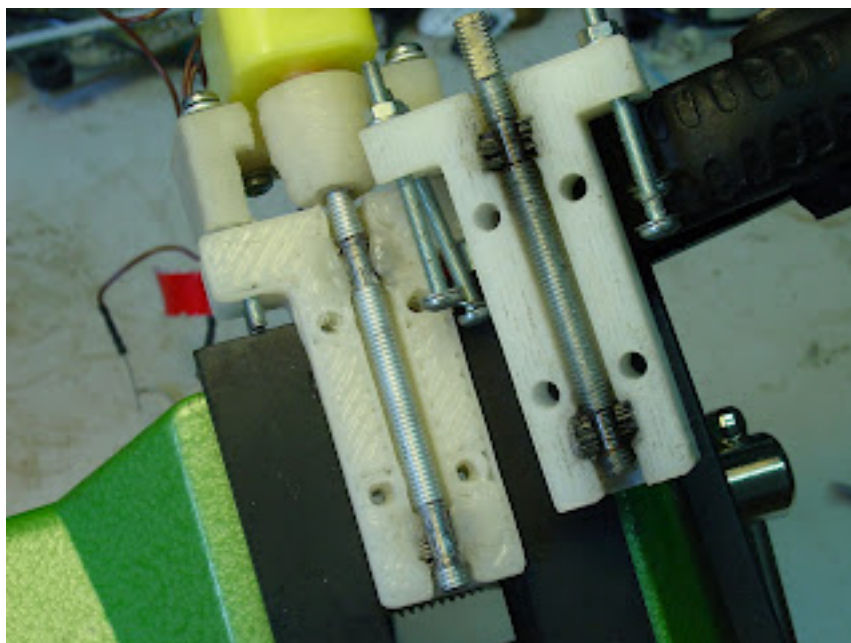

I've taken advantage of the squishy properties of CAPA a bit, I know, but it seems to work. Now we just hope the bearings don't heat up enough to melt the CAPA when you run them fast.

Keep on reading for our shameless fund-raising plug...

Vik :v)

Darwin makes a move

Monday, 5th March 2007 by eD

I tested a bit of Darwin today. I asked the Z to go up and down 20 times, putting the motor through 1000 steps for each stroke. This, in theory, would only move the bed up and down by 3 mm, but there was some timeout error going on in my code, so that's as far as I could push it today. Testing over a big range is on the list, but it's repeatability I'm interested in, so 3 mm will do for now.

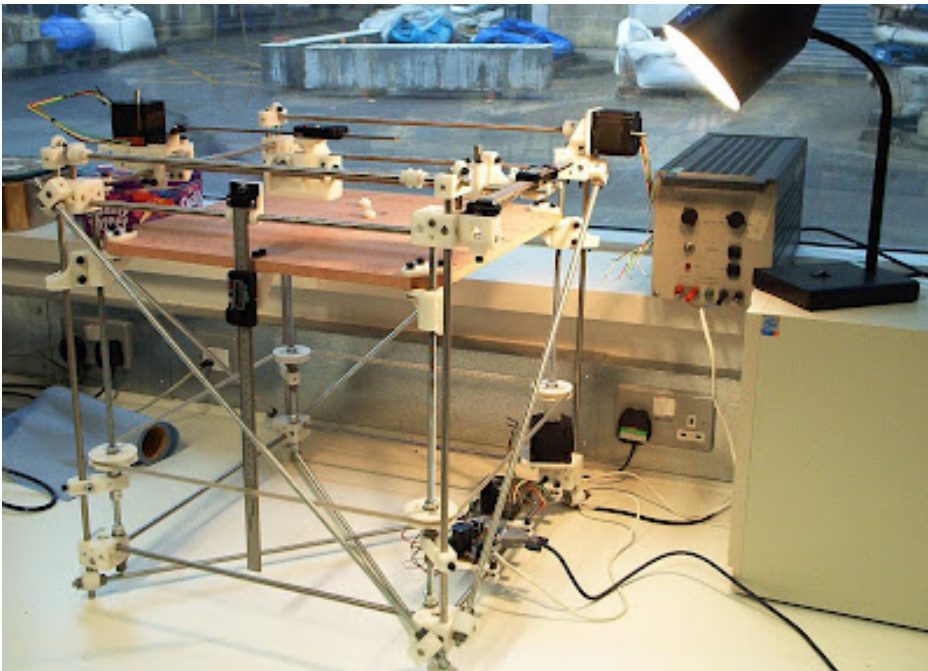

The motor torque was at 100%, speed 200 (see exerciser scale - approx 80%), and the results on the caliper bolted to the bed were... well... the graph can do the talking:

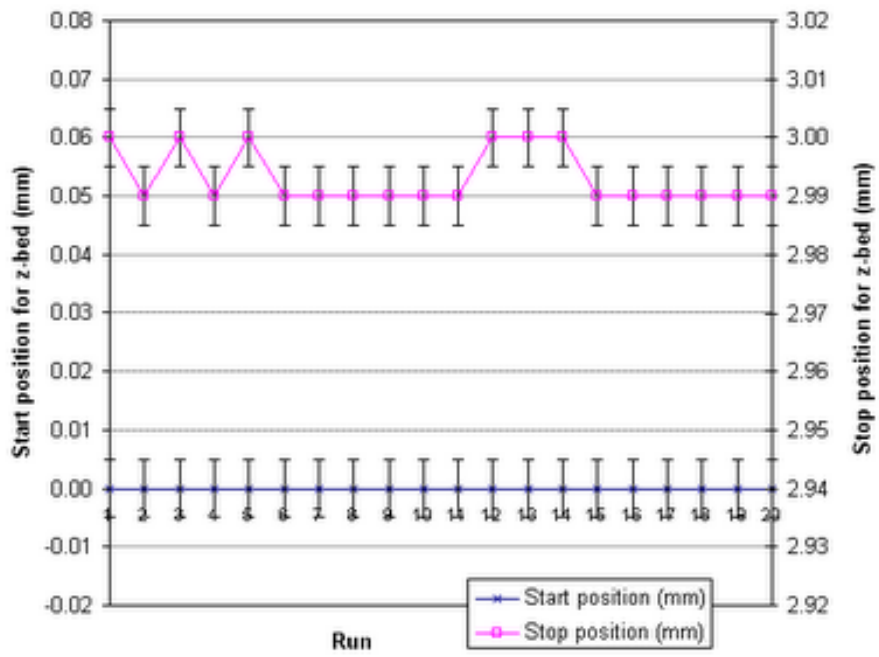

Happy days! I guess that puts the resolution at ± 0.01 mm. There's still the X&Y to get moving yet, but it's good to know they're on solid foundations ;-)

Sebastien's polyethylene glycol

Tuesday, 6th March 2007 by Adrian Bowyer

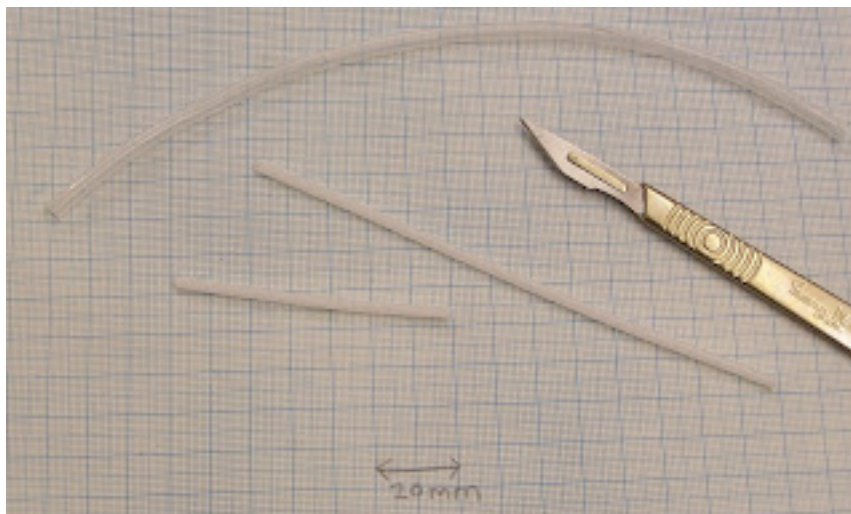

Sebastien mailed me a couple of kilos of polyethylene glycol. This is a water-soluble wax-like polymer that melts around 70 °C. We have been thinking of using it as a support material.

I've been playing with it, and on its own it's much too fluid when molten - it has a viscosity similar to water. It thickens as it cools, but in order to get an extruded filament that way one would need far too fine a temperature control.

So I melted some and mixed it (2:3 by weight) with icing sugar. That makes a paste which is the ideal consistency. And it sets to a material that is like candle wax, but is water soluble (because both the sugar and the polyethylene glycol are).

I used the same trick as I used the other day to make a 3mm rod of Wood's metal - squirting it from a syringe down a 3mm silicone tube, letting it freeze, then splitting that off with a scalpel. It's a bit brittle (as you can see its broken in two). This is good for support material removal, but for other tasks it would help if it was more flexible.

I tried mixing it with glycerin as a plasticiser (medically, polyethylene glycol is often mixed with glycerin), but it seemed to react with the sugar to curdle and form lumps. This itself was interesting, but not quite what I wanted. so I'll see if I can find another compound that will make it more pliable. If I can do that it will definitely go through the standard extruder.

The Extruded Extruder Extrudes!

Tuesday, 6th March 2007 by Vik Olliver

I tidied up the bearings and rammed a pin through the top of the screw thread to join it to the coupler. It now extrudes! Yay! Can't say for how long because it's strong enough to split the nozzle, or at least blow out the weak parts on it. Closer inspection shows where I cut things just a little too fine drilling the nozzle out, and a bit of soldering is required to patch it.

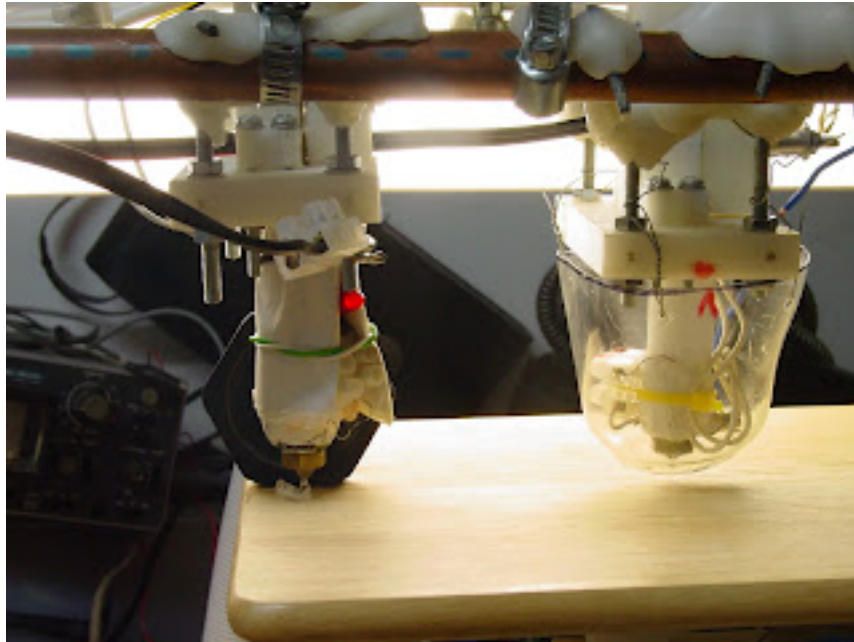

The extruded extruder is the one with the red light on. The black thing on the board is just to allow a bit of contrast so you can see the extruded stuff. I've used an ABS clamp off the Stratasys to hold the PTFE part of the nozzle, but I aim to replace that when the software is running happily again.

Zaphod now has two heads.

Vik :v)

BBQ paint fails

Friday, 9th March 2007 by Forrest Higgs

Just a note in passing. While I was checking out Tommelise so that it will be ready for printing tests this weekend now that the PC-side software to let it print real things is operational I noticed that the insulation on the extruder barrel heating coil had gone white. That means that we're looking at the glass insulation left after both the paint and much of the silicone insulation has boiled away.

I did a careful check and noticed as well that in places it was no longer stuck to the BBQ paint on the extruder barrel. While the heating coil was loose, it was not standing away from the barrel. I used only 175 mm of #32 nichrome 80 on this barrel in a single strand, so the loops in the coil are well away from each other.

Just to note I've had about 14 hours of hot operation on the this barrel to date. When I talk about "hot" operation, I'm talking about measured extruder barrel temperatures in the vicinity of 200-205 degrees C. I've had about the same number of hours of operation on my old test barrel which has been operated at about 140 degrees C. until very recently when I started trying to extrude ordinary solder. The BBQ on that one is still as good visually as the day I built it.

What that means is that if you use this approach with CAPA don't expect to encounter BBQ paint failure like I have.

Right now I'm in the process of putting another six coats of BBQ paint on the barrel to tack down the heating coil again. It's a sunny day out in my shady little patio where I'm doing that and that's going well.

Moulding thin walled gears, succeeds (!)

Monday, 12th March 2007 by eD

Moving the X & Y on darwin to resolutions of 0.1 mm directly from a 400 step motor equates to drive gear diameters of about 12mm. For Darwn's Y, these need to sit on a 8mm shaft. This means verythin walled gears. Vik's idea of moulding the capa into the belt to create the toothed gear has worked brilliantly in the past so I was trying to do that again. But this time things got tricky because stuffing the capa into such a small volume was extremely tricky (see pic).



The final solution was to pack the capa into a former section wich held the teeth, mount that on a blade section with a 8mm hole, hold the two concentricly in a pot and ram a file'd-up 8mm spike through the lot. Pre-packing the former guarantees the toothed impression, as does the angle of the spike, the blade nips off the excess, and the whole lot is easy to break apart after the capa's set.

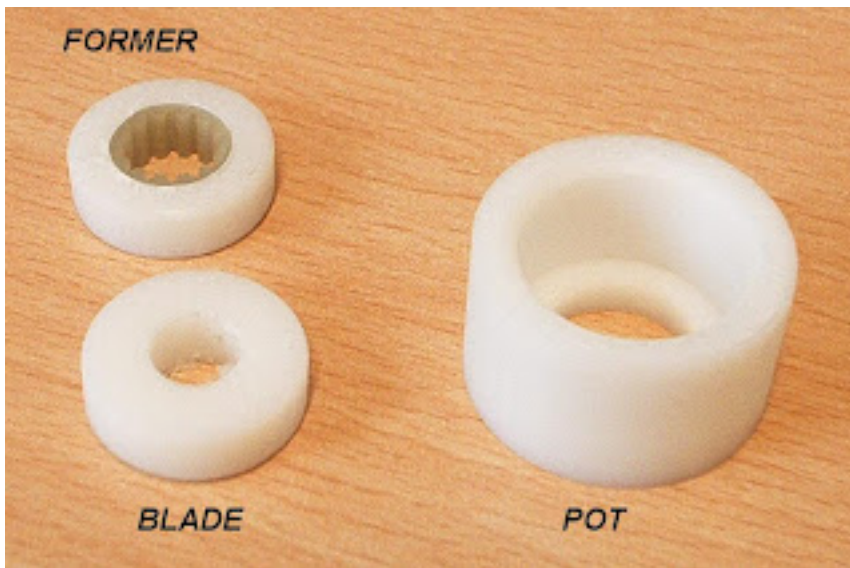
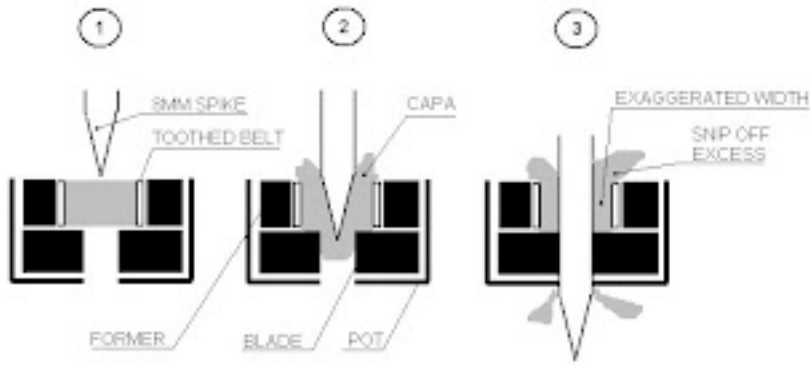

After a bit of trimming, Bob's your uncle, as we say over here. (And, if your from the wrong part of over here, bob can also be your dad).



Darwin's X-axis toothed pulley

Friday, 16th March 2007 by eD

The last gear problem for Darwin, casting a 12 mm gear to fit on a 6.35 mm motor shaft. A flat was needed to ensure no slippage on such a thin shaft. Final solution was to use the same kit used to make the Y gears (see previous post). The collar was prepacked again, but this time, because there was a bit more wall thickness, the hole was simply started by working a screwdriver into the capa. The collar was then put into the pot with a new blade part which fitted the motor shaft profile. The motor shaft was then poked in from the back. Worked first time.

This was then complemented with Vik's superb idea of a washer + bit of capa for the second lip.

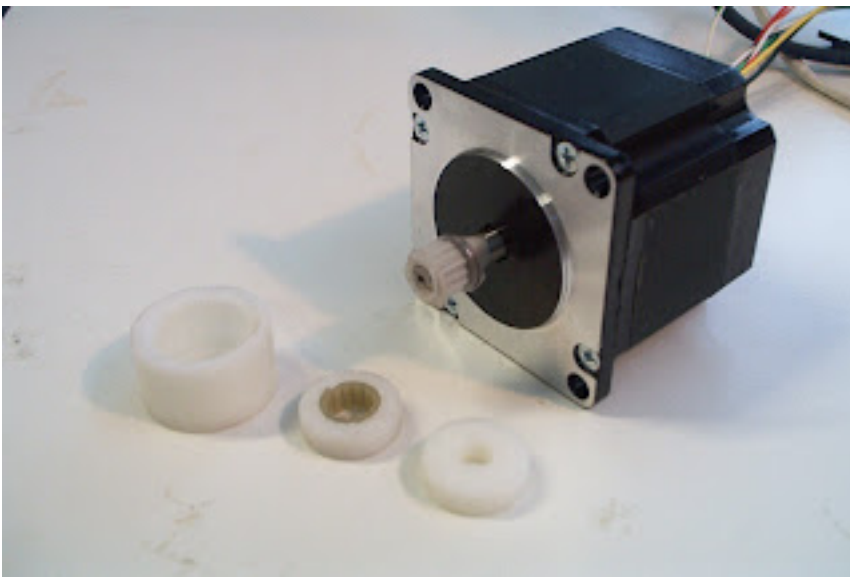

Next: a repeatability test for the X. Though I need to solder up a universal PCB first...

Darwin's Y-axis repeatability

Friday, 16th March 2007 by eD

Firstly, I've been issued with IE7 which means Blogger actually works properly on my computer... I cannot express the joy!

Secondly and more importantly, the toothed pulleys from the previous post were put on the Y-axis. Big thanks to Adrian for sorting out the electronics and the repeatability programming!

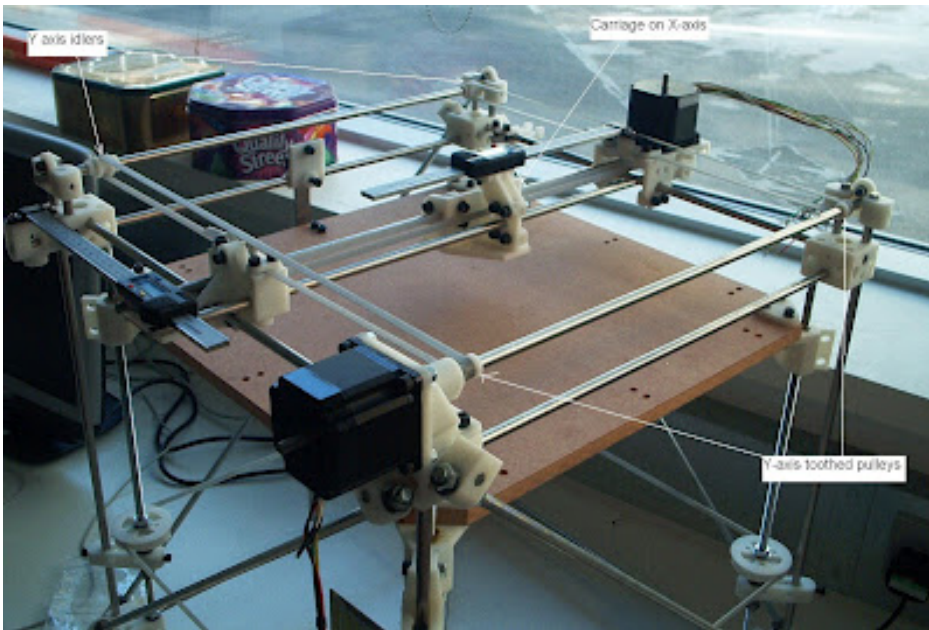

Super glue was used to lock the little gears into position on the 8 mm drive bar. [Incorporating flats are on the development list]. The same repeatability test used on the Z-axis (see previous post) was re-used, results below:

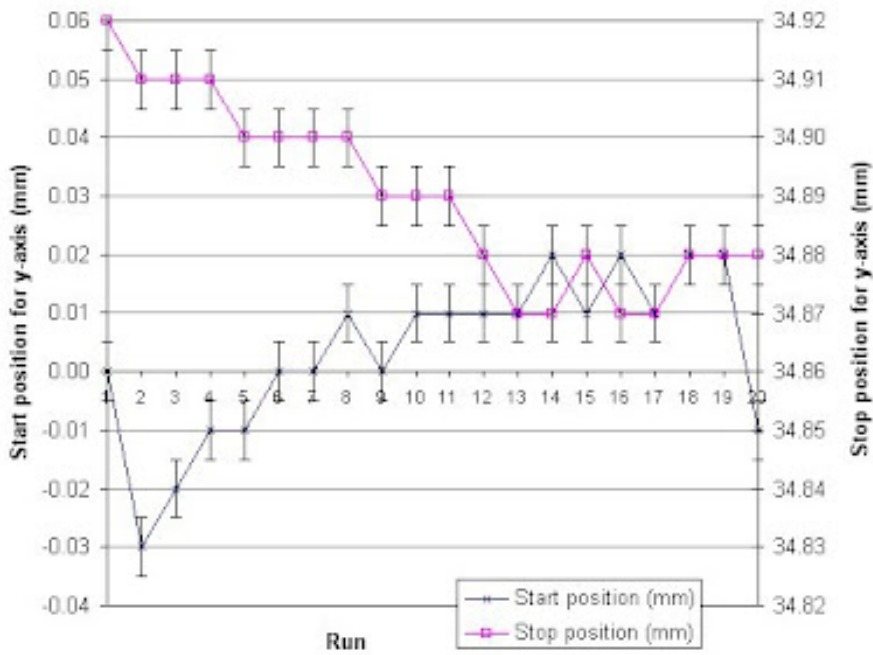

After the first ten runs the repeatability appears to be in the ballpark of ± 0.04 mm. I think that the first few runs balance the tension: this is important because the transmission isn't symmetrical:

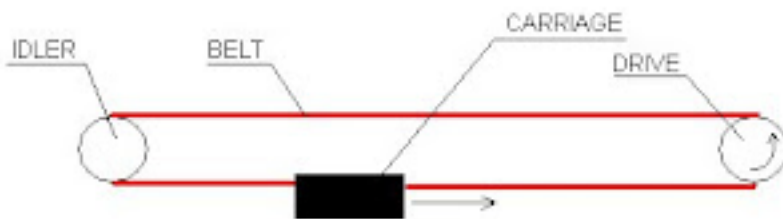

It's worth stressing that this is not bad, we're still within our targets, but we need more data to pin down exactly what's going on. The next test will need 100+ runs.

PowerComms v1.1: Success!

Friday, 16th March 2007 by Zach Smith

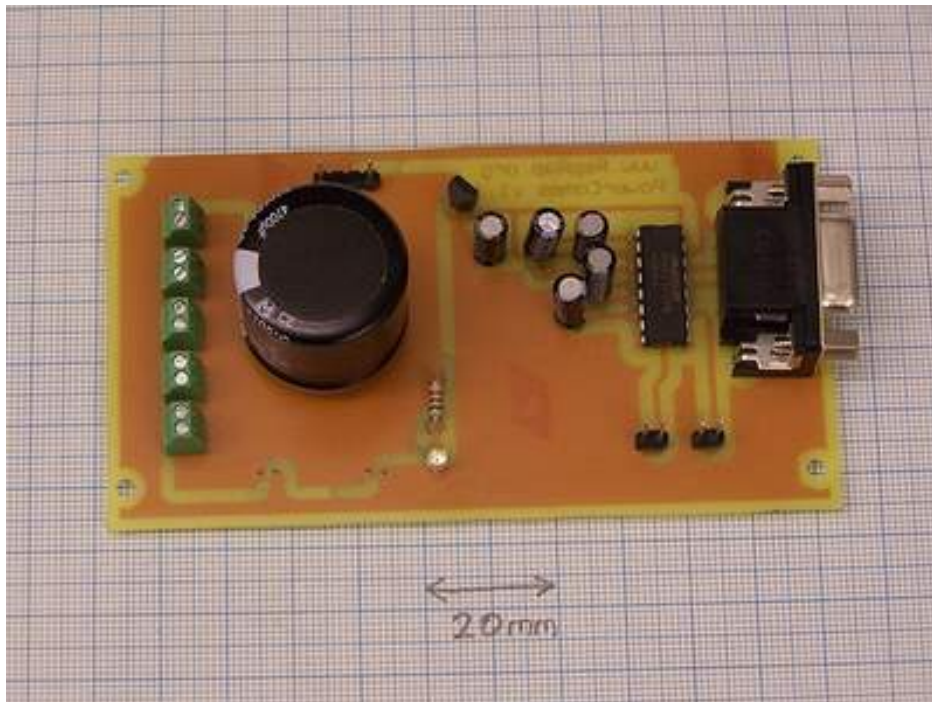

Adrian has successfully etched and soldered up one of the new one-sided Power / Communications boards for Darwin. Apparently it went really well, and I think he may even be picking up my vernacular. In his email he described it:

it's really sweet - wholething took me 2 hours from cutting the bag round the virgin PCB to finishing testing (plus a 30 minute etching break when I ate supper). Tested out A OK first time

Updated instructions w/ the new pictures will be up on the wiki shortly.

Bendy extruder gets things straight

Friday, 23rd March 2007 by Adrian Bowyer

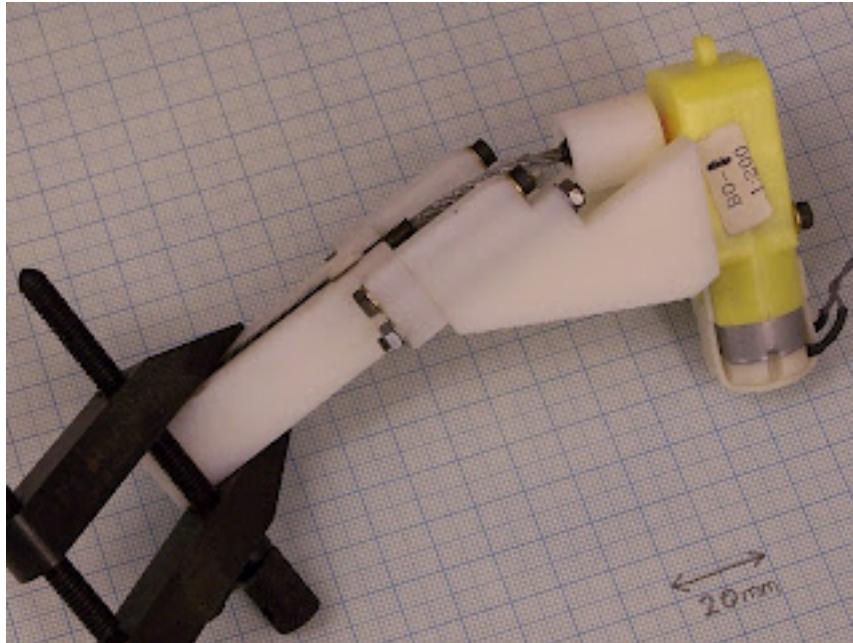

I've done an alternative to the polymer extruder design that allows the 3mm diameter input filament to run straight down the drive screw without bending. This should allow us to use more brittle and stiffer materials in addition to CAPA. It should also make it easier to drop short lengths of filament down it from an automatic magazine at the side of the machine, for materials that can't be put on a long roll.

I drilled a 5mm-deep 3mm hole in the top of the M5 drive screw and soldered in a length of 3mm steel hawser that I bought at the local hardware shop. I had to grind/file down the hawser end a bit to get it to fit; I also added a little solder flux to get good surface wetting. It was important to be parsimonious with the solder, lest it soak up the wire and make it go rigid. On the other end I soldered another short piece of M5 studding, then soldered an M5 nut onto that.

I modified the motor mount to move it back from the line of travel of the filament being extruded, and made a small drive with an M5-nut-shaped hole.

Rather conveniently the predominant drive direction (anti-clockwise) tends to tighten the hawser coils, though the thing does drive perfectly well in both directions.

There's a video of the first mechanical test on [the RepRap videos page](#).

Time-lapse video of test hexagon.

Sunday, 25th March 2007 by Vik Olliver

A few people have asked me if I would make a short time-lapse movie of something being RepRapped. So, thank you for the inspiration. I finally got round to it on the second attempt, after earlier borrowing a higher quality camera that unfortunately lacked macro focus:

The object is a standard 20mm (approx) test hexagon, 5mm (quite accurate) thick, extruded from CAPA. There are approximately 2.5 seconds per frame. I used a Linux script of my own devising and a Logitech 320x240 webcam clamped to the base board, which I will document and GPL if anyone is interested. Donations of higher quality equipment greatfully accepted!

Here's what that lot looks like:

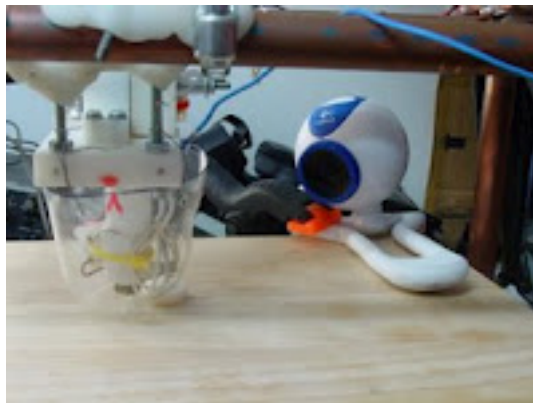

Vik :v)

Darwin's X axis repeatability

Monday, 26th March 2007 by eD

Appologies, this has been a bit slow coming - I've had the lurg. The final repeatability test for Darwin: here we're looking at the performance of the x-axis after mouding a gear diectly on to the motor (see the previous "Darwin's X-axis toothed pulley" post). Results are, again, looking promising with repeatability to ± 0.025 . Again, a further test is needed at a later date to understand how asymptotic the trends are, but as with the other two axes, we're in the right ball park here.

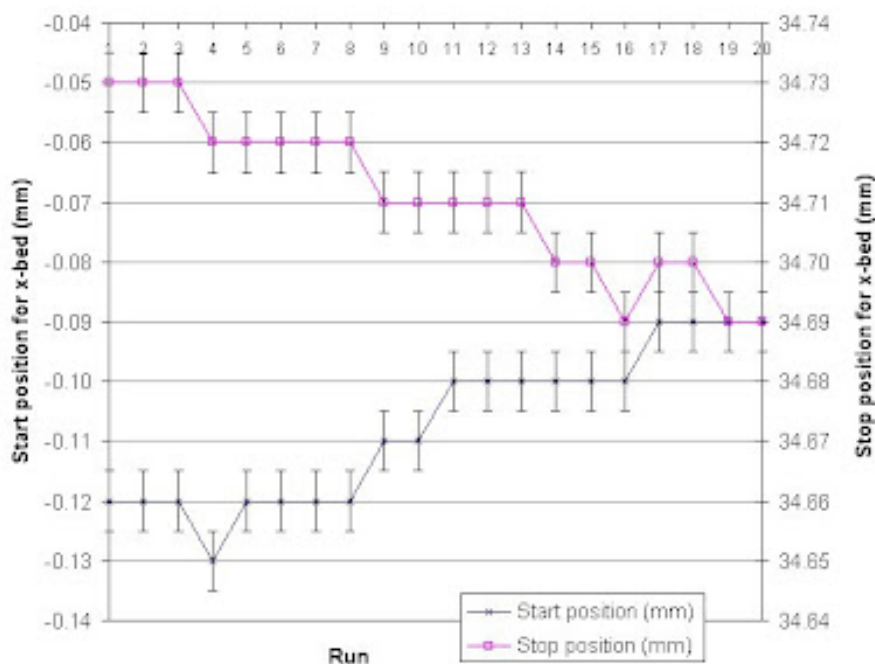

Next on Darwin's todo list.. home sensors, wiring & documentation.

Untimely Lapse Movie

Tuesday, 27th March 2007 by Vik Olliver

I've had a go at printing one of Ed's Darwin corner brackets. On about the 5th layer, the output detached itself from the stage and got pushed around a bit. While this wasn't exactly a huge success, it does look very much like we're on the right track so I've been persuaded to post the video. As per the last one, there are approximately 2.5 seconds between each frame.

Right at the end you can see the deposited part start to detach and go springy before it gets pushed around. You can also see the second head appearing in the right of the frame in the latter half of the movie. The camera moves around a little as the USB lead was dragging on things, but I fixed that with some tape about half way through; not a problem as it actually gave a better camera angle!

Adhesion to the stage (or lack thereof) is my big bugbear, and I'm going to try a light coat of varnish as previous tests have shown molten CAPA sticks to it like glue. If that doesn't work, I'm onto foam bases like the rest of 'em.

Vik :v)

ETech 2007

Saturday, 31st March 2007 by Forrest Higgs

My son Adriaan and I just got back from San Diego. The presentation at ETech Thursday afternoon went VERY well. The audience was between 75-110 or so. The high ~\$1,500-odd registration fee seemed to serve as a good filter for filling the audience with highly qualified, very motivated people from just about everywhere.

Adriaan tried to take pics of the presentation with his digital camera. Unfortunately, the hall was quite dark for the presentation which made his attempts dicey at best. This one is, however, my personal favourite.



I especially liked the vampire eyes thing. There were several business and technical media folks there. One American who writes for a Japanese business journal had much better digital camera equipment than we did and did extensive photography of the presentation. I'm hoping that I will be able to borrow a few of his pics for our archive.

I made the pitch for self-replicating printers, RepRap and Tommelise and we got good applause and very good questions in return. Afterward we had about a dozen of the people who'd attended stay over. Most of them had already been on both the RepRap and the Tommelise websites and one Brit there had even been down to Bath to meet Adrian.

There were people who were selling 3D printers, design engineers, product engineers and the lot. We've got a couple more product design firms that are probably going to be hammering for

Darwins.

I also heard an excellent and interesting rationale for why a professional firm would want a self-replicating printer. It goes like this. They're paying \$4.50/cubic inch for filament and if they don't use the filament that comes from the vendor they have their warranty voided. They resent that a LOT.

As well, they'd like a printer that they could try different things with and fix if it broke. What we're working on fits that to a "T". As it is, the machines they have typically can only deal with one kind of plastic. The product design firms would like to do printing with a machine that wasn't a black box like the commercial machines.

One thing on the reprop site that really impressed the the people who are using commercial 3D printers was when both Vik and Adrian and Ed made shot glasses. You apparently can't make waterproof glasses on a stratasys. I heard about the tendency of stratasys prints to delaminate on the z-axis again, too.

Anyhow, the talk was well-received and O'Reilly was happy with it so we'll probably be asked again.

I noticed that several blogs had picked up on my talk. We got pretty good reviews.

Darwin assembly instructions

Monday, 9th April 2007 by eD

The parts list and how to put them all together is now on the wiki: in the 'How to build it' section, under "Cartesian Assembly".

Another time lapse - the logo (almost)

Tuesday, 10th April 2007 by Vik Olliver

I had a go at printing the logo, which adequately exercised the boundaries of our software's stability. Erm, cough, yes, well.

However, eldest daughter (who today arranged some form of novel time-delayed laundry detergent dispenser to explode in my workshop) reckons it is officially "cool" and therefore worthy of mention on the blog. I give you our Logo, RepRap'd in one piece:



Also, there is a video of it here as a 2.5sec/frame time lapse. Of course, Dorkus here filmed it upside-down...

Vik :v)

Congratulations to ArtOfIllusion

Wednesday, 11th April 2007 by Vik Olliver

The free and Open ArtOfIllusion 3D graphics studio - the one we use to build our parts - gets the Sourceforge "Project of the Month" award for its slick features and friendly GUI. Details at <http://sourceforge.net/potm/potm-2007-04.php>

Congratulations to Peter Eastman, Nik and all the other contributors on their achievement. May they continue to produce excellent software.

Vik :v)

What happens when a US National Laboratory tries to make a RepRap

Wednesday, 11th April 2007 by Forrest Higgs

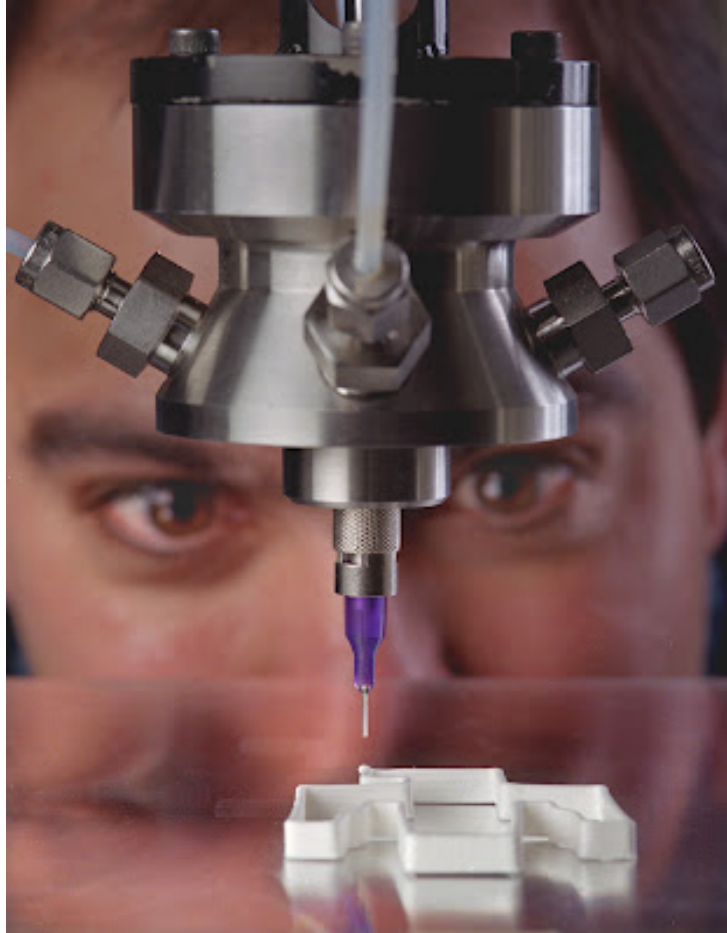

Note the bent walls and corner blobbing. :-D

You Look Like My (proto)Type

Wednesday, 11th April 2007 by Zach Smith

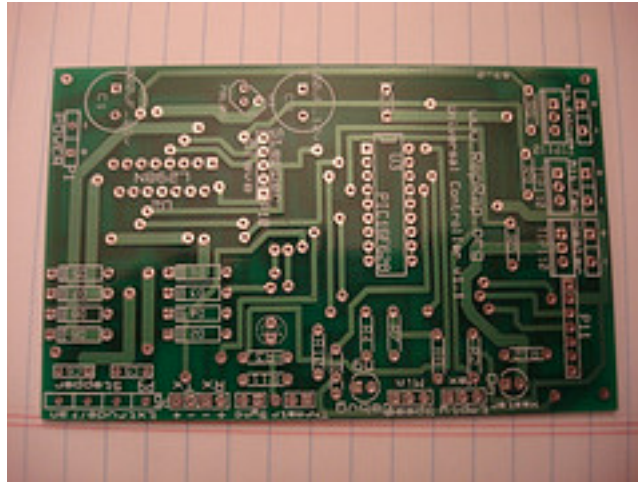

I was really worried about the prototype boards, since they were due to be delivered to my work the DAY we were scheduled to move uptown to Union Square. Luckily, they still got delivered okay. Boy do they look sweet!! I got a couple sets up on Flickr on them and heres a pic of the universal board.

I'll be making the bulk order later this week. I want to test everything and also need to do a few tweaks to the layout.

[PowerComms Pics](#)

[Universal Controller Pics](#)

Tommelise joins Zaphod and A.R.N.I.E.

Saturday, 14th April 2007 by Forrest Higgs

There are now three open source 3D RepRap printers that have passed the "print a shot glass" milestone.



That's a standard British 25 ml short shot glass. I was halfway through my second shot before it occurred to me that it was 1000 in the morning, I'd had 3 hours sleep the previous night and hadn't made breakfast yet. I've been hammering getting the shot glass print done, you see.

You can read a complete account of the adventure [here](#). Be sure and click on the "Continue reading" link at the bottom of the blog entry to get the complete account.

You can't spread a bit of CAPA on your copper

Tuesday, 17th April 2007 by Vik Olliver

Yesterday I bought a piece of copper-clad board and tried sticking it under Zaphod. The idea being to deposit a trail of CAPA on the copper and then etch the exposed copper. Unfortunately, it looks like copper makes a nigh on perfect non-stick surface for CAPA extrusions. Even after cleaning with contact cleaner and cranking up the heat, I couldn't get any CAPA at all to stick to the copper.

Looks like time for plan B; the etch resist pen.

Vik :v)

Printing HDPE on copper.

Wednesday, 18th April 2007 by Forrest Higgs

You're just not doing it right, Vik. Mind, I tried to do exactly the same thing with Tommelise a few weeks ago with identical results. I didn't blog it at the time but when I read your blog entry this morning I realised what I did wrong.

There is a way to make it happen, though it may be more useful for what I have in mind than for your idea of using CAPA for photoresist.

[\(Read the full story\)](#)

RepRap wasn't built in a day

Sunday, 22nd April 2007 by Adrian Bowyer

At the end of last week I assembled our first RepRap Version 1.0 "Darwin" from scratch and shot a time-lapse video of the entire thing at one frame every three seconds. It took me four and a half hours spread over two days (I have to teach sometimes...).

Annoyingly, Ed appears from time to time to hinder proceedings using something that I understand is called a "sense of humour", so it is through gritted teeth and with a dark heart* that I have to say that he has done a truly outstanding design job. This is the first time that I have built the machine (all my work so far has been on extruders), and it went perfectly from his instructions on the [RepRap Wiki here](#). Also, the way that he uses bits of the part-constructed machine as jigs and templates to allow one accurately to build and align other bits is, frankly, inspired. You will notice that the only measurements that I make are with an ordinary tape measure.

(*Metaphors getting out of hand here, AB. Steady.)

i <3 aluminum

Friday, 27th April 2007 by Zach Smith



since i live practically across the river from mcmaster, i get FAST delivery times. they had my aluminum nuts and bolts here the next day. so once i got my aluminum, i went straight to the shop.

first, i started by drilling the aluminum bolts out with a long series 1/8". unfortunately my cheapo drill press only has a 2" travel, so i had to finish it with a hand drill. also, i dont have a decent clamping setup yet, so it was with a vicegrip.... not a good solution. (cross slide vice = ordered)

however, things worked great! the drilling of the aluminum was super easy, slightly slow on my part. the bit had no problem handling it. there is probably a better way to do that, but it was actually pretty simple.



after i warmed up with the bolts, i approached the main issue: the nozzle. unfortunately, i broke all my 0.5mm nozzles, so i used the random ones. first i tried 0.90. piece of cake. it made cool spirals

of tiny aluminum. then came 0.7mm. also really easy. it melted like butter. i had an untouched grab bag of 0.15 - 0.40, so i decided to see how low i could go.

i loaded up the 0.40, brought it down on the aluminum, and it snapped! aargh. first try and its busted. well, i was actually just a bit over eager, because that was only one of two bits i broke drilling holes. i tried again and easily got a 0.40 nozzle.



then i went down the sizes: 0.35 went well... just slow and careful. same with 0.30, 0.25. then i got to 0.15 which is an insanely small size of a hole. unfortunately the bit broke... i think my drill press is just too loose to handle it. it certainly could've drilled through the aluminum.

i drilled a couple of each size, just to see how it went... the nozzles were very easy to drill. infact, the acorn nozzles are practically perfect for an extruder head. heres why:

1. the inside of the nut tapers up into a point near the top. its actually very thin. thats why its so easy to drill through... i dont know how to measure it, but its very thin.
2. the bolt screws all the way in. there is only a small gap between the end of the bolt and the cone area. i dont know the physics behind polymer flow, but it seems right to me.
3. the aluminum conducts good heat, not as good as copper, but still very good.

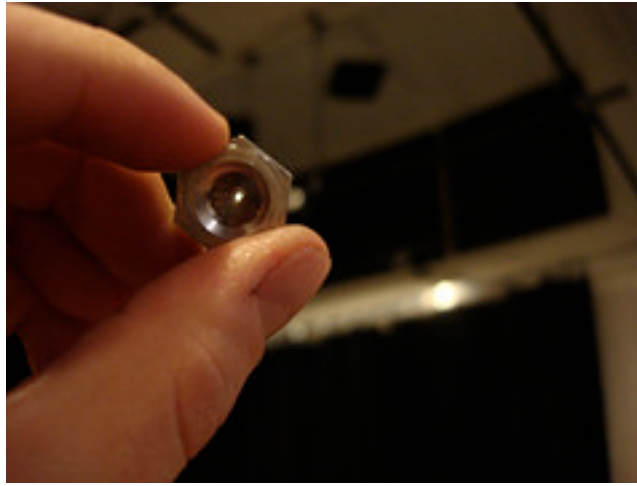

so, after that, i rushed back to the lab at home. i had to try extrusion! i already had a steel extruder barrel worked up, so i wired it up and screwed a large mm aluminum nut on... there wasnt enough thread, so the nut only went halfway on. even with that large chamber of plastic, extrusion still worked.

i got a decent stream of 0.7, and 0.4 also came out pretty well. i got tired of manually feeding it, so i stopped for the night. i want to wait until i hook up one of the new aluminum barrels i got to see how it works.

Aluminum Barrel Success!

Saturday, 28th April 2007 by Zach Smith

After letting the JBWeld cure, I was ready to get down to business and try some extrusion tests. I had my nozzles arrayed before me, my power supply ready to rock, and some alligator clips ready to clip. I knew the 0.7mm and bigger ones would extrude, so what I was really interested in was how the 0.4mm and smaller ones would perform. I had my doubts... but they were completely wrong. I usually try to save the best for last, but I cant. All nozzles (including the 0.25mm nozzle) extruded beautifully and at a good rate. I took measurements with my cheapo digital calipers. They may be a bit off, but they were close enough.

this was all done with HDPE.

0.40mm nozzle = 0.75/0.80 diameter thread

0.35mm = 0.60-0.70

0.30 = 0.50

0.25 = 0.40

those last two were very surprising for me. i honestly didnt think the 0.25 one was going to work at all. boy was i wrong. they all extruded very well. the smaller ones werent even very slow. the HDPE came out fine, and in a nice even stream.

next, i wanted to try some of the more advanced polymers that Sebastien sent me. first up was ABS. i cleared a barrel, loaded up a length, and started to heat it up. i waited a few minutes and tried some extrusions. it just wasnt having it. i may have been impatient and gave up too early, because when i pulled the ABS out to examine it, it was definitely malleable and soft. i dont know if it goes transparent like HDPE does when its melted, but it looked like it was nearly there. perhaps i need a hotter barrel, or to wait longer. i'll find out soon =)

after that, i decided to try the UHMW HDPE (this is basically a *very* nice version of HDPE). i loaded some up in a fresh barrel, turned it on, and waited a few minutes. this stuff extrudes like a DREAM! it came out faster, and better than regular HDPE. i dont have any hard numbers to back it up, but I have a feeling that this stuff could become my polymer of choice (until i can get ABS to work.)

i dont have any pics for this one as it is really hard to photograph the filament. anyone know where i can get reverse graph paper? (black paper, white lines?) i suppose i could just use normal black paper, but i like the way the graph paper gives you scale automatically. picked that habit up from Adrian =)

Opto-endstop cutie pie'd

Tuesday, 1st May 2007 by eD

After ARNIE, Adrian and I have been cooking up better ways to fit the optoswitch for the axis endstops. We've designed this 50mm long assembly for Darwin so that it comes with its own PCB and clamp (as standard).

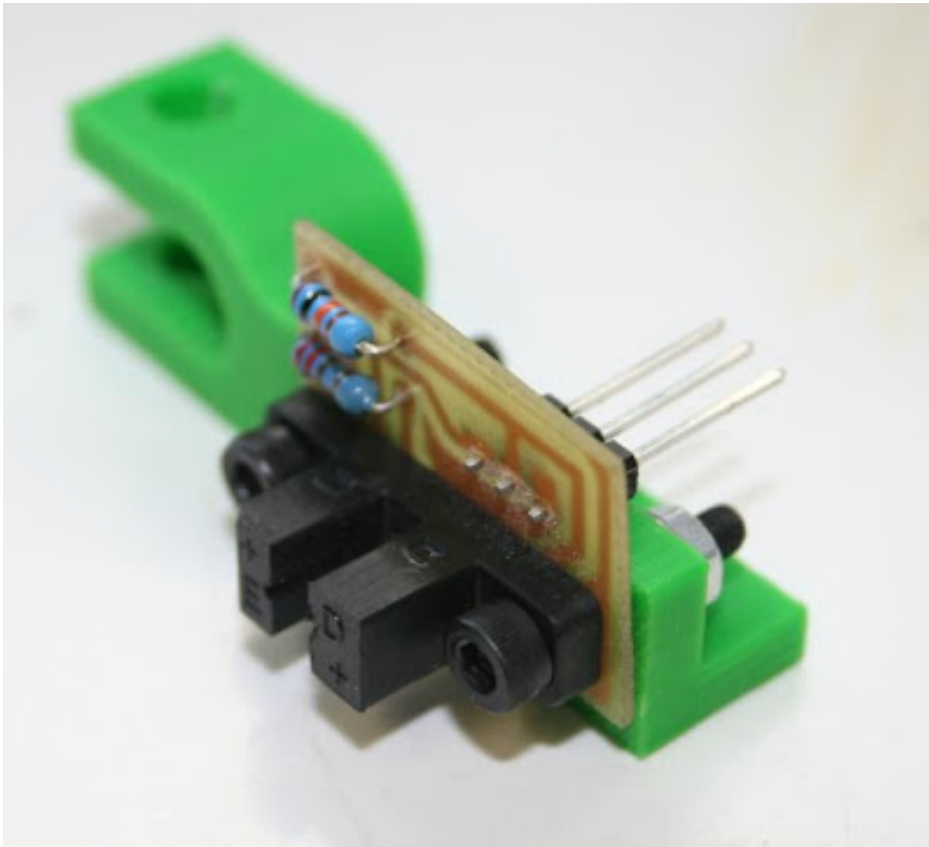

Assembly instructions have been wikified [here](#).

Flags for the axis have been fitted and, although there's a couple of mods to do, Darwin is on its way to being wired

PowerComms & Universal v1.2

Sunday, 6th May 2007 by Zach Smith

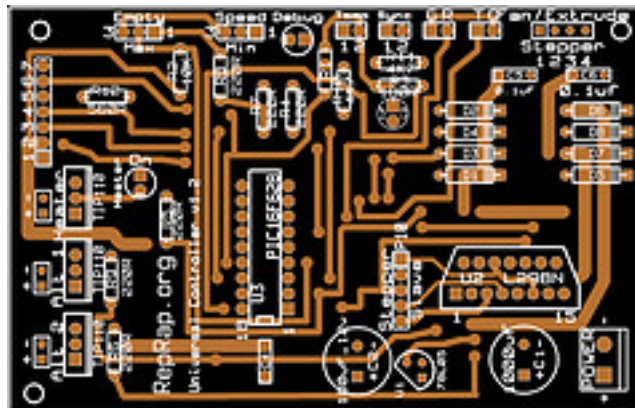

Its taken me long enough, but I've finally gotten around to getting the production ready versions of both the PowerComms and Universal Controller boards done. As a test, I uploaded them to www.batchpcb.com and they both passed DRC.

I'll be doing an order of 25 sets to start things off. There has been alot of interest in the forums and elsewhere, so hopefully that will be enough to get boards for everyone. If the demand is high enough, I'll be doing another order soon afterwards.

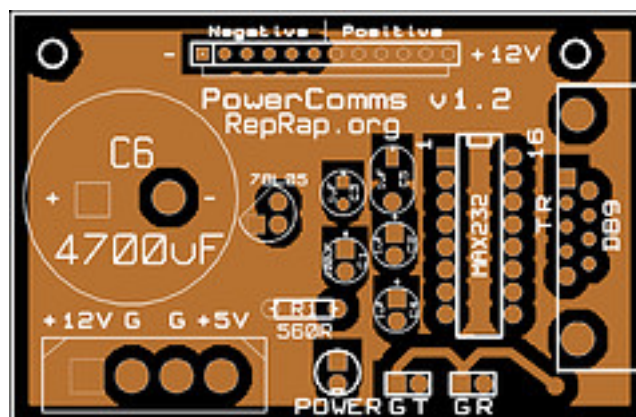

If anyone notices any glaring errors or omissions, please let me know. The boards are in subversion under [electronics/PowerComms](#) and [electronics/UniversalController](#) if you'd like to take a look in KiCad.

Catwalk

Thursday, 10th May 2007 by Adrian Bowyer

Here is the official Darwin-finished pic:

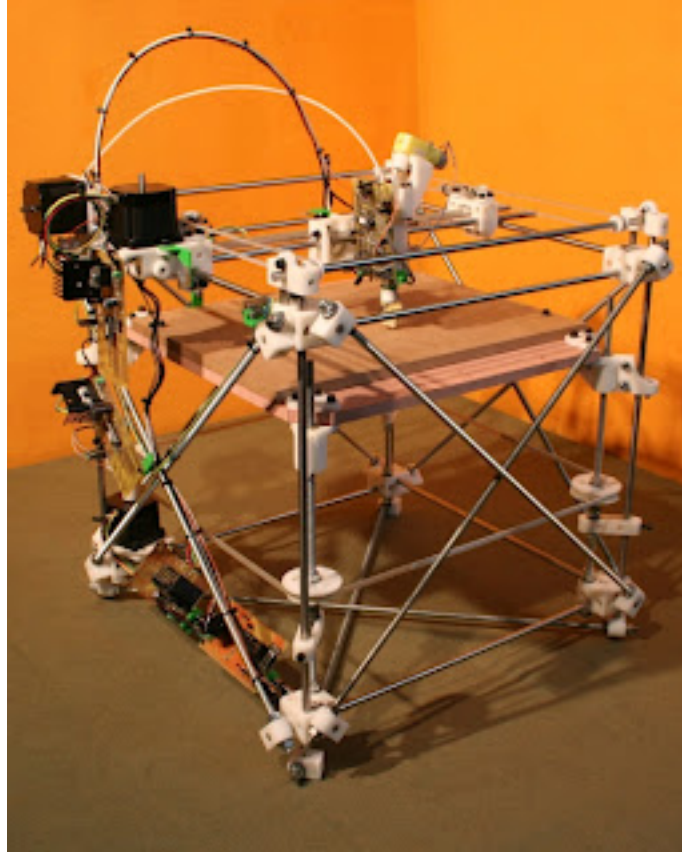

Ed's powering it up the wrong way caused less smoke than my typing an extra zero in the extruder temperature box by mistake...

Here's the very first test.



As you can see, the fibreglass insulation round the extruder makes it look slightly like Cousin It...

Wired

Thursday, 10th May 2007 by eD

Since the time lapse video of Darwin's exo-skeleton, Adrian and I have been working on wiring the beast up and making sure she runs ticketty boo. There's been a few additions and redesigns to fit in all the electronic wizardry, including the homing devices, for the first release. The job's been a shed load simpler than ARNIE was thanks to Adrian's timely suggestion of keeping all the motors on one side... so now its' looking the biz:

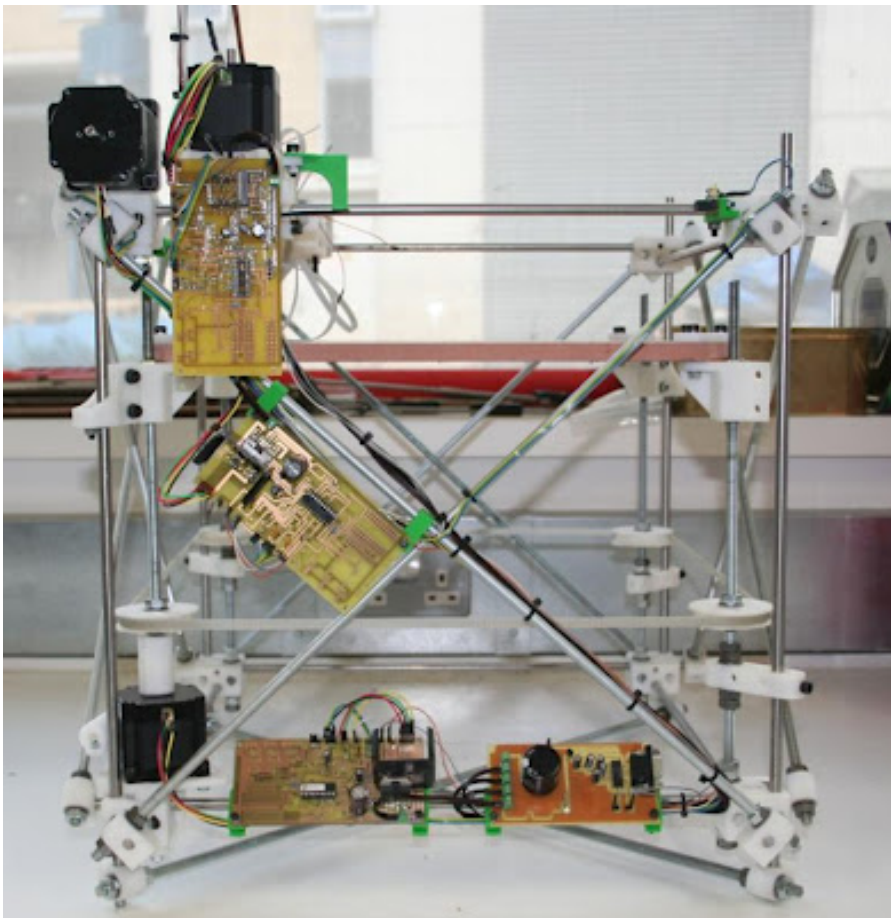

After a near miss with me chucking the power down it the wrong way (after Adrian specifically told me not to hit the juice till we'd checked it, and me hitting the juice before we'd checked it [but it was like a waterslide on a hot day!] - I'm still surprise he didn't get physical!!!), all the LED's now come on, and we'll be putting it through the traditional shotglass paces tomorrow. The whiskey's on standby.

PLA Filament works

Sunday, 13th May 2007 by Vik Olliver

Back at the start of the year, plastics suppliers Claraint were kind enough to donate 10kg of polylactic acid (PLA) granules to the RepRap Project. Alan from Imagin Plastics - a welding rod and extrusion specialist in Henderson, New Zealand - then ran these granules through an extruder to produce 800m of 3mm diameter filament which I picked up on Friday. It was dried overnight at 60C and then extruded using a 180C die and 170C feed. Here's there wondrous extrusion machine:



And here's the batch of filament I picked up. It's actually quite transparent.



By running an unmodified Mk2 extruder at 155C and increasing the pressure on the filament - it's

much harder than CAPA - I managed to run it well enough to produce this shotglass:

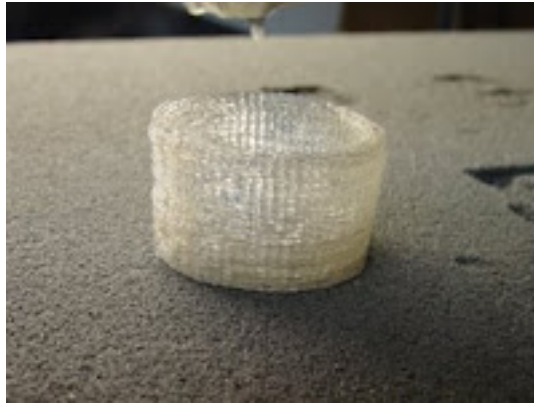

This material definitely has some artistic possibilities.

Further experimentation is needed, but it does look like it will be possible to make watertight containers with a reasonable degree of strength from PLA in a Darwin. A straight-through extruder would probably have an easier time feeding filament, as the stuff is rather stiff.

Vik :v)

RepRap needs your JAVA help!

Monday, 14th May 2007 by Zach Smith

We are looking for someone to help develop and maintain the RepRap control software. This is an essential part of the project that needs to be easy and intuitive to use for it to ever gain mainstream adoption. Fortunately, its probably the easiest and least groundbreaking part of the system... and yet still exciting!

The software is the main method of interacting with and controlling the RepRap machine. Unfortunately it is hard to install, needs some UI work, could use some more intelligence with auto-detection/configuration, and has some bugs. The software can also be run in a stand-alone mode without a RepRap machine attached. That means you can get involved in a meaningful way even if you have no interest or capabilities to build the machine. One could do development work without ever having a RepRap machine at all.

There are a variety of tasks that range from simple to hard. Even small improvements to our code would be awesome. As an added bonus, if you agree to take on this challenge, the project is willing to provide free development boards to you. If you are interested, please email hoeken@rrrf.org directly, or visit our [support forums](#).

To get started now, check out the [RepRap Java development instructions](#).

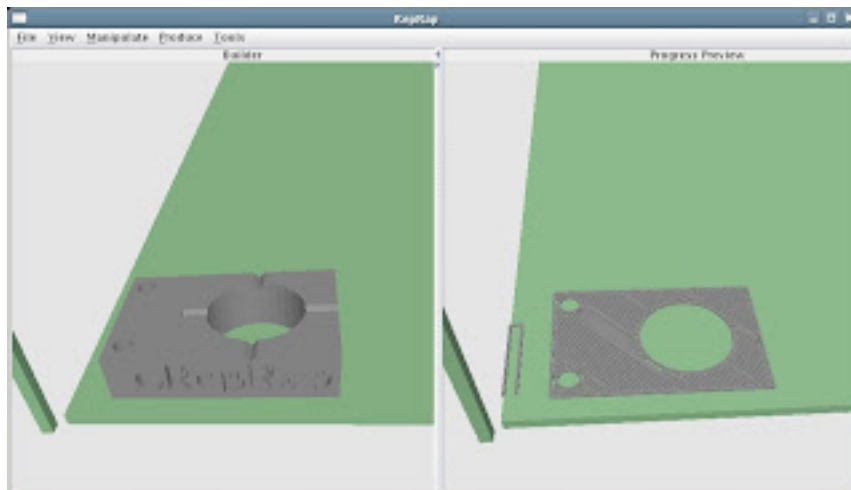

Slimline Darwin Designs

Tuesday, 15th May 2007 by Adrian Bowyer

Many thanks to Eric Morgan and Bart Anderson, who have laboured past the witching hour unenlightened but for the sepulchral glow of a USB memory stick LED until the first crow of the cock caused the outline of the old ghost in the stable yard to fade softly into the limestone walls*, and who have run all the Darwin STL files through Aol to clean them up and greatly reduce their size.

The new clean ones can now be downloaded from SourceForge at

http://sourceforge.net/project/showfiles.php?group_id=159590

Great work, chaps!

*This imagery may be over the top, but I'm not sure...

Flask with overhangs in PLA

Tuesday, 15th May 2007 by Vik Olliver

I've done this nice little flask to test overhangs in PLA. At 40mm high, this is the tallest thing Zaphod can currently make. The extrusion was done at 157-160C and the deposited trail is 1.4mm wide:



Unfortunately is not waterproof. This is because I re-set the bearings, and as they settled in the feed rate dropped. This left a few small gaps in the base. Obviously, a fixable thing. It is durable though and shows no sign of wanting to de-laminate.

If you look inside you can see all these little hair-like threads that got dragged around during the fabrication process. Very pretty :)

Vik :v)

More squiggles...

Friday, 18th May 2007 by Forrest Higgs

Lol! If it's support you want, HDPE does a fair job. :-D

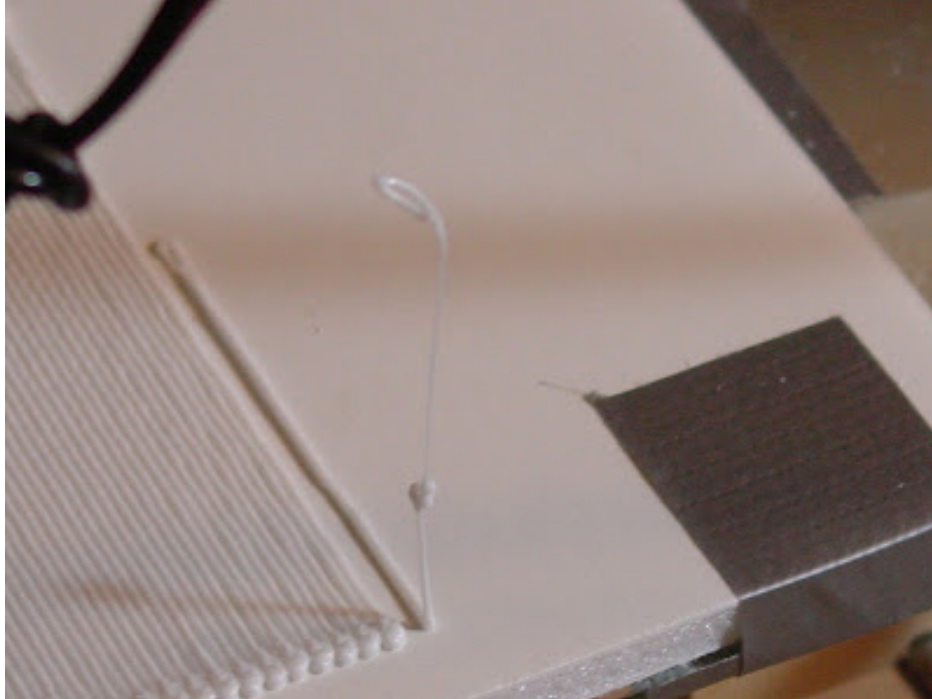

Support material miracle

Friday, 18th May 2007 by Vik Olliver

While playing around with the PLA, I (Vik) noticed that the PLA can be formed into loops that would normally require support material. It might be possible to use the rapid hardening properties of PLA to build objects without support material in some cases:

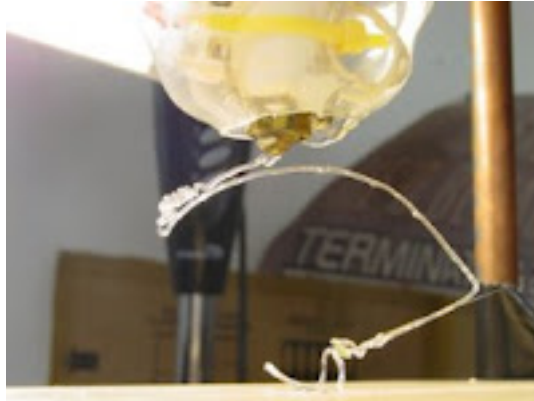

Another support material miracle?

Saturday, 19th May 2007 by Forrest Higgs

While I was doing some practice prints last night to get used to printing on duct tape something very unexpected happened. Recently, I've been working to get the polymer flow rate coordinated very closely with the extruder head velocity. Last evening I accidentally managed to do that with a heretofore unencountered precision in a peculiar situation that produced some very interesting results.

I had laid down an HDPE raft and was trying to print a layer of the Mk 1 polymer pump on top of that. I had had trouble getting the layering interval right and managed to get it about 0.75 mm higher than it should have been. Ordinarily, that would have just made a mess of squiggled extrusions instead of a print.

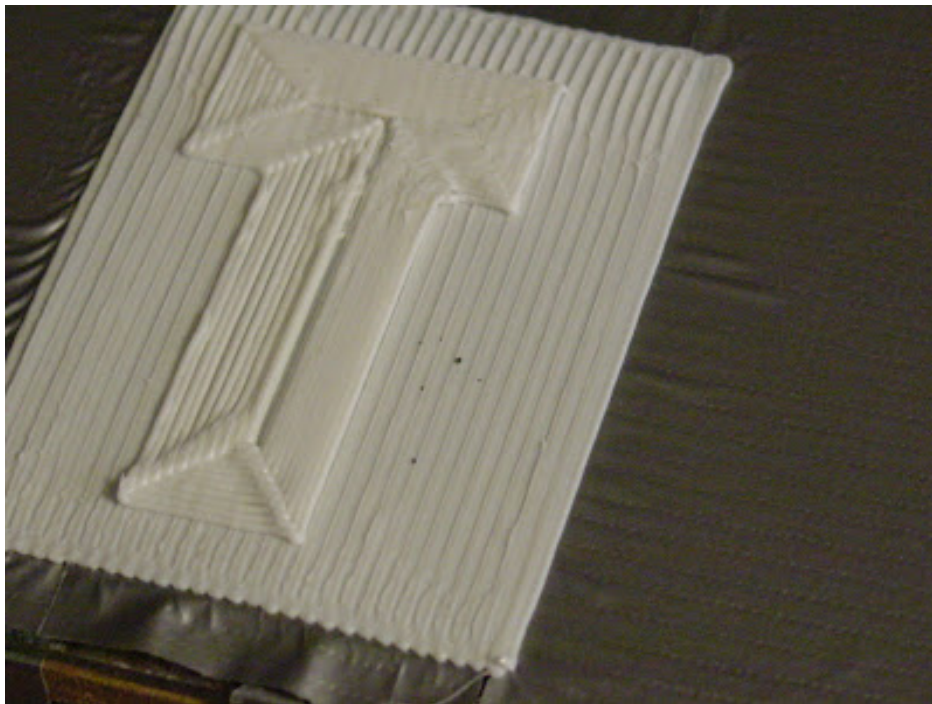

All the same it made for a rather messy print as you can clearly see. It had been a long day and I had demonstrated that I could successfully print on HDPE, so I nearly just packed it in and went to bed. As I was shutting Tommelise down, however, I reached over to turn off the worktable light and in doing so noticed a very consistent shadow under the right hand side.

I'm very used to seeing that sort of thing when the extrusion doesn't adhere to the raft. In this case, however, the shadow was long and even rather than short and humped. I hadn't seen something like that before, so I used a small metal rule to see if I could determine the extent of this

gap.



If I was intrigued before I was astonished when the rule easily slid fully 7 mm under the extrusion.

[\(Read the full story\)](#)

PLA Darwin part

Tuesday, 22nd May 2007 by Vik Olliver

By raising the extrusion temperature to 165C I've managed to get PLA going through without blowing up the extruder motor - earlier attempts tightened the clamp too much and overloaded the poor little motor (may it rest in peace). PLA strings more than CAPA, but is significantly more rigid. Here is a Darwin bed clamp that I printed off on Zaphod last night:



The holes have since been cleared of stringing with a penknife. I'll try some more complex Darwin parts later, but there are some modifications needed to the code to conserve memory for large or complex builds.

I've also got to fit the modified extruder drive - the one with a flexible shaft. Hopefully this will let the rigid PLA filament feed more freely still.

Vik :v)

Announcing the RepRap Research Foundation

Wednesday, 23rd May 2007 by Zach Smith

I'm happy to bring you news today that we have gotten our incorporation papers back, and the RepRap Research Foundation (RRRF) is now an official non-profit corporation according to the United States of America. We are now working on the next stage, which is to achieve tax exemption. (If anyone is a lawyer or knows one that would like to help with this pro-bono, please have them contact us!)

So, what exactly is the RRRF? Well, it is an organization dedicated to helping researchers (you!) involved in the RepRap project. The goal is to play a support role by offering research parts for sale at low prices. They will remain separate entities, but will obviously maintain a close relationship.

The main way it will be doing this, is by providing an online store where researchers (yes, that means you!) can purchase various parts at low prices. Things such as PCB's, extruder nozzles / barrels, motors, and part kits that would otherwise be too expensive to order directly / individually. In essence, the RRRF will harness the economies of scale in order to make it easy (and cheap!) to get involved with the project. Also, since it is non-profit and run by volunteers (you/me!) the prices will be super low.

So, please come check us out!

Purchase parts at our online store: <http://parts.rrrf.org>

Visit the foundation homepage for detailed information: <http://www.rrrf.org>

PowerComms v1.2 Build

Thursday, 24th May 2007 by Zach Smith

A few days ago, the first batch of boards arrived from China. I decided to solder up a PowerComms board, and record it as a time-lapse video. It went pretty smoothly, so check it out.

Unfortunately there were 2 problems. First, I placed the wrong component, no big deal. Second, is that I swapped the 5v and 12v inputs on the silkscreen! That means you either have to slightly re-wire your connector, or solder in the header in backwards (the better solution) Its definitely no show-stopper, but I will fix this for v1.3 of the board.

Darwin parts analysis

Friday, 25th May 2007 by eD

I thought it'd be interesting to take the BoM and analyse Darwin's parts (so to speak) to see how we did in terms of our part types. Different parameters give different results (e.g. weight, volume), but the most useful is probably part count. Here's the proportions of parts for a Darwin machine including one Mk2 extruder.

Notes:

- each pcb board including all its bits counts as one electronic part
- all the wires counts as one part

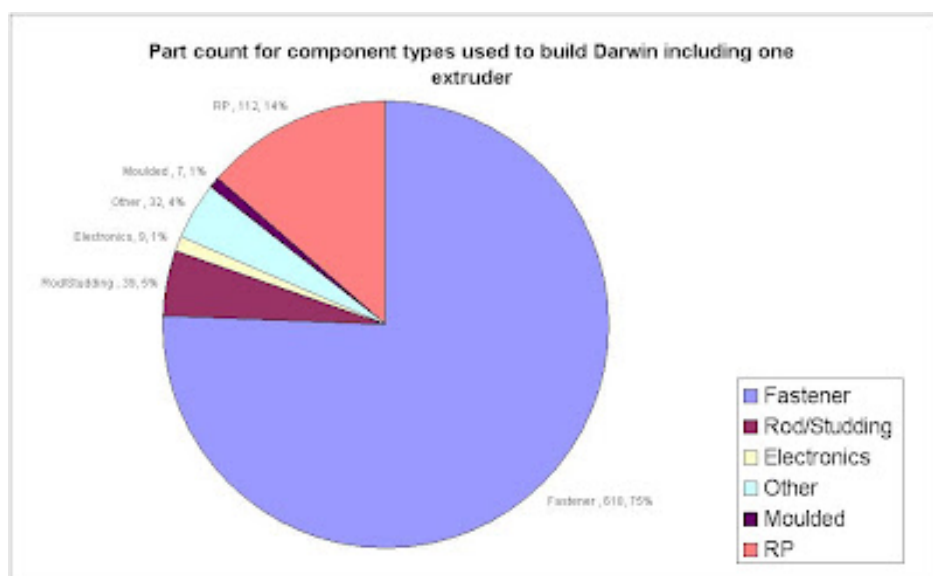

The problem with a part count analysis is that it looks at the average fastener as four parts (nut, bolt, 2 washers). Seeing as we're eventually looking to swap fasteners for RP snap fits here's the analysis without the fasteners:

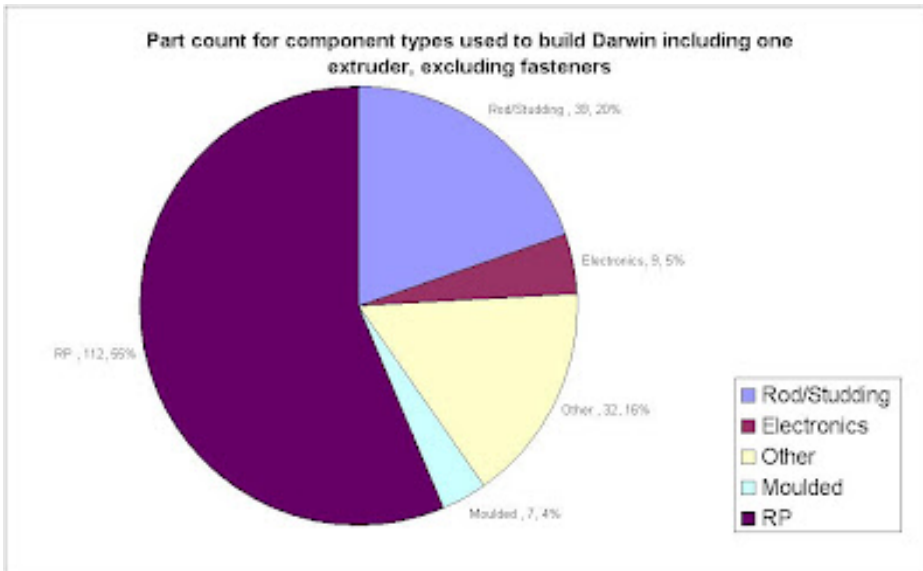

So what's that "others" proportion made up of I hear you cry:

- Plastic bag (moulding release)
- Timing belt
- Capa
- Stepper motor
- Spring
- Grease
- Bed (MDF)
- Fan
- PTFE barrel holder (PTFE rod)
- 200:1 geared motor
- 200mm Heater wire (0.2mm nichrome)
- Thermistor
- Flexible coupling (steel wire)
- Silicone tube
- Grease
- High-temp epoxy (JB Weld)
- Plumber's thread seal tape
- Half bearing (brass)

I think for our first release we've succeeded with Darwin by keeping this "others" list low, and equally importantly, widely accessible - all in all a solid development platform I reckon. Nice one chaps!! All Mendel's got to do is 'build on this' (heheh. heheheheh. heh. sorry.)

PLA Darwin Parts From Zaphod

Monday, 28th May 2007 by Vik Olliver

I've run off a couple of PCB clips and a couple of brackets from PLA. You can see the stringing on the X constraint bracket - it looks like it as been enveloped by a spider. The thread can easily be picked off with a sharp point, fortunately.



The blob on top of the constraint bracket is where the software crashed. Fortunately it waited for the last layer...

Vik :v)

Opto Endstop Boards Arrived!

Thursday, 31st May 2007 by Zach Smith

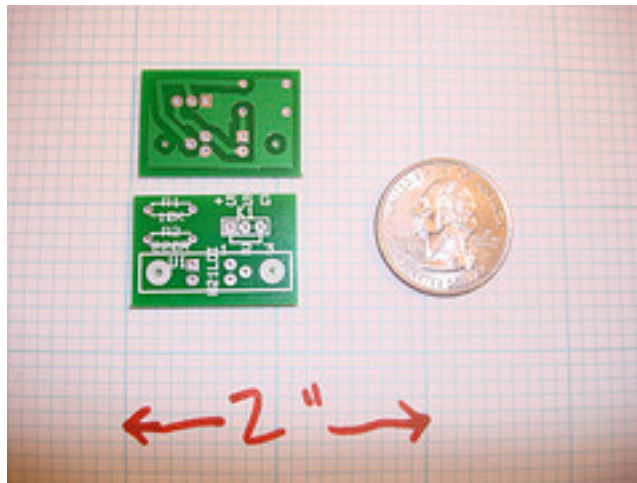

The commercially manufactured boards have arrived! These tiny little boards are the guys that tell your RepRap machine where each end is. They are great, except for one tiny defect: I don't know how to place big holes in Kicad, so the mounting holes are too small. Nothing a little bit of drilling can't fix though. Unit cost came out to ~\$0.75 / ea.

Anyway, you can read more about it on the [RRRF blog](#), or jump straight to [the store](#) if you'd like to buy some. (Is it a shameless plug if it's on your own website?)

Very fine RepRap nozzles

Wednesday, 6th June 2007 by Adrian Bowyer

I am visiting Jens Kaufmann at Heriot Watt University to give a RepRap talk to his group. He has come up with a really neat way to make very fine nozzles for RepRap.

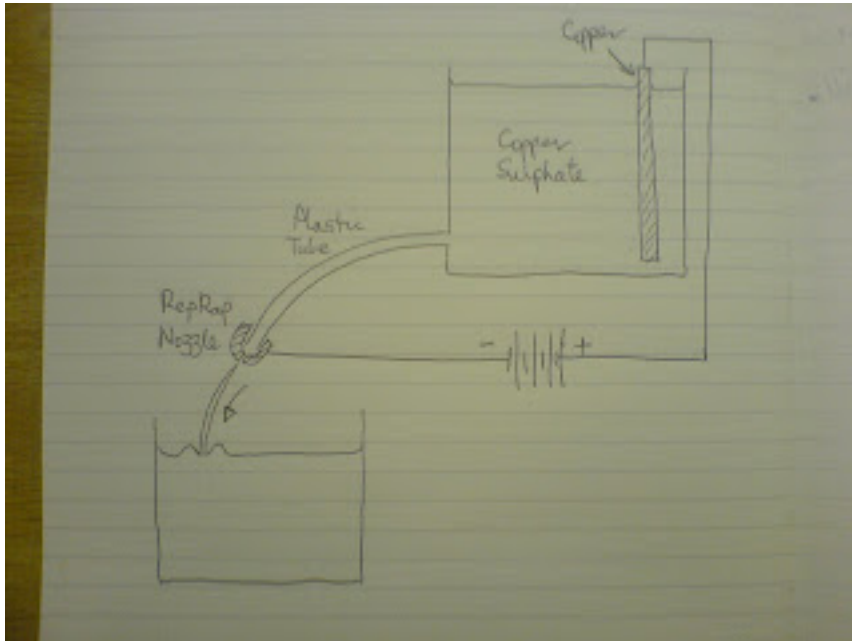

Stick a standard nozzle with an 0.5mm hole on the end of a piece of silicone tube. Then flow copper sulphate solution through it and connect it up to copper-plate itself from a lump of Cu in the top bath (see the pic). The copper will plate on the inside of the hole closing it up. The thing has beautiful negative feedback, in that - if an area starts to close up too fast - the plating rate drops just at that location.

You can tell how the diameter is reducing by watching the flow out of the end slowing down. A few experiments would quickly establish how far up the side of the receiving vessel the level would rise in 30 seconds (owe) for a given diameter. Just time it, and turn off the electricity when you get there...

For best results it needs a constant-current source so you get a precise plating rate. You stuff the silicone tube right into the nozzle to prevent the threads being plated too.

Brilliant!

RepRap Host v0.8 Released

Wednesday, 6th June 2007 by Zach Smith

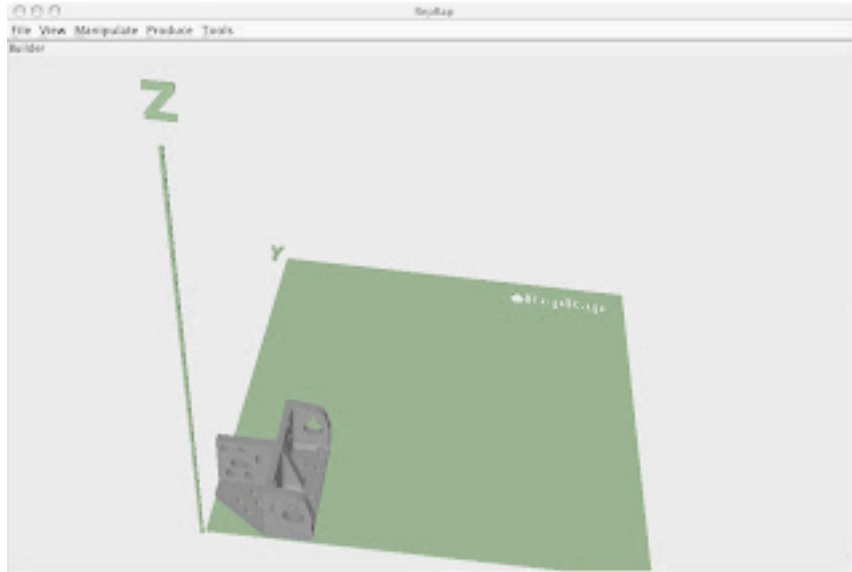

Thanks mainly to Jonathan Marsden. I'm proud to announce that we've released v0.8 of the RepRap Host software. This is a major milestone for us. Previously, installing and running the host software meant setting up a development environment and compiling the code. With this release, we have a cross-platform compiled .jar, ready to use out of the box. We have also switched to the rxtx library, which is a replacement for the java comms api. it is licensed much more nicely, is easier to install, and works great.

This is a v0.8 release, due to the fact that there are still a few known bugs, most notably the fact that it crashes on large prints of 3d objects. Apparently its an easy fix, so if anyone is interested, please check out the source. We have automated the build process, so we can roll out your changes much easier now. Jonathan Marsden is our reluctant java hero, and he would love some help if you are willing. There are plenty of bugs large and small left to squash.

Please download and run it, even if you don't have a RepRap machine. It can simulate the print process, so someone could work on the software without even having a machine!

V1.2 Universal Extruder Board Assembly

Saturday, 9th June 2007 by Vik Olliver

I've got the assembly instructions done for the Universal PCB V1.2 board you can get from the RRRF. Now available [here](#) for public comment and ridicule:

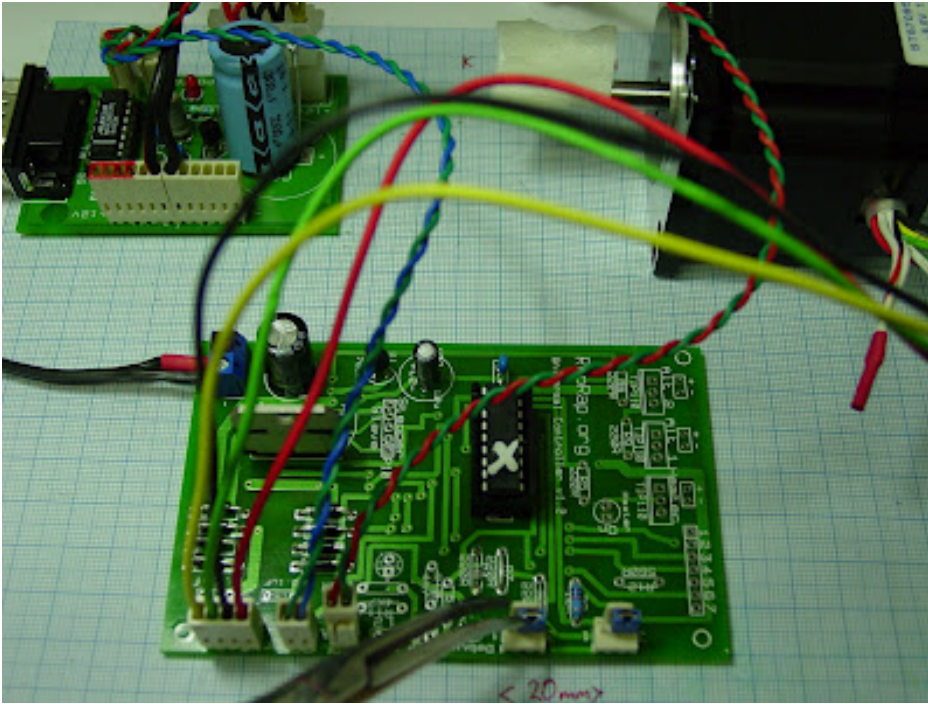

I'm part way through the extruder board instructions, so cut me some slack on that one!

Vik :v)

RepRap V1.2 Stepper Controller Board instructions done.

Friday, 15th June 2007 by Vik Olliver

I've now done the stepper controller instructions for the V1.2 board as well. They were much easier and I could re-use a lot of Adrian and Zach's original prose. Check [here](#) for yourself.



Vik :v)

Token ring gold

Tuesday, 19th June 2007 by Adrian Bowyer

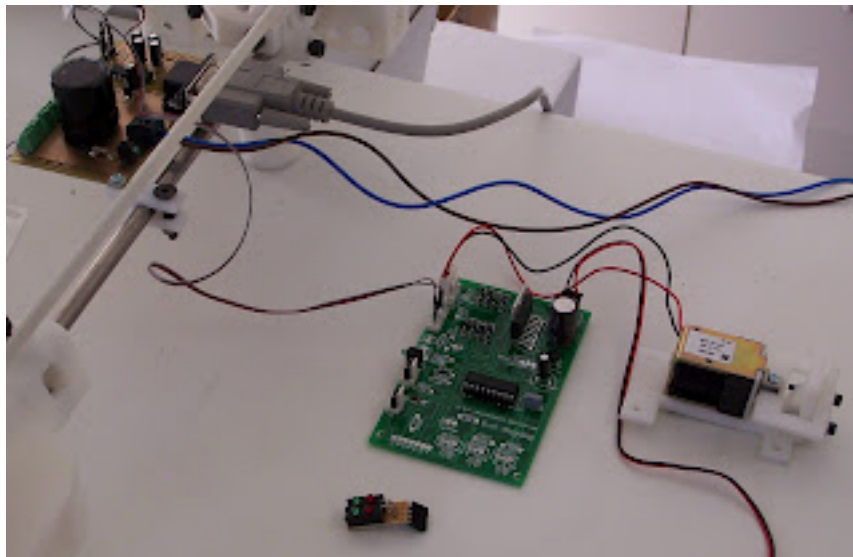

The decision we made early on to give each RepRap component its own controller on a token ring is really paying dividends: development is now made so simple*.

I'm adding another extruder based on the Coke-bottle/balloon idea blogged [here](#).

It needs a timed solenoid controller - the solenoid is on the right in the picture, its controller is in the middle, and the RepRap machine is off to the left. I'll get the new device working on the bench, then bolt it into the machine.

Getting it going is proving really easy* - just break out of the token ring on the Communications/Power PCB to a new controller board (supplied by the very wonderful [RepRap Research Foundation](#)), power it from the same source, copy the old extruder firmware to a new directory, give it a new address in the Makefile, and away you go.

Testing couldn't be simpler* - you program a PIC, plug it into the controller, and wind up the Java RepRap control program; the extruder test function now allows you to select which extruder you want. It takes me about a minute to go through the cycle of amending the firmware, putting it in the PIC, and trying it out.

*As soon as this is posted The Fates may read it, of course, and then my boasting will get its reward - easy and simple will become hard and complicated.

Are Klotho, Lakheisis and Atropos online, does anyone know?...

Silicone enhanced RepRap

Thursday, 28th June 2007 by Adrian Bowyer

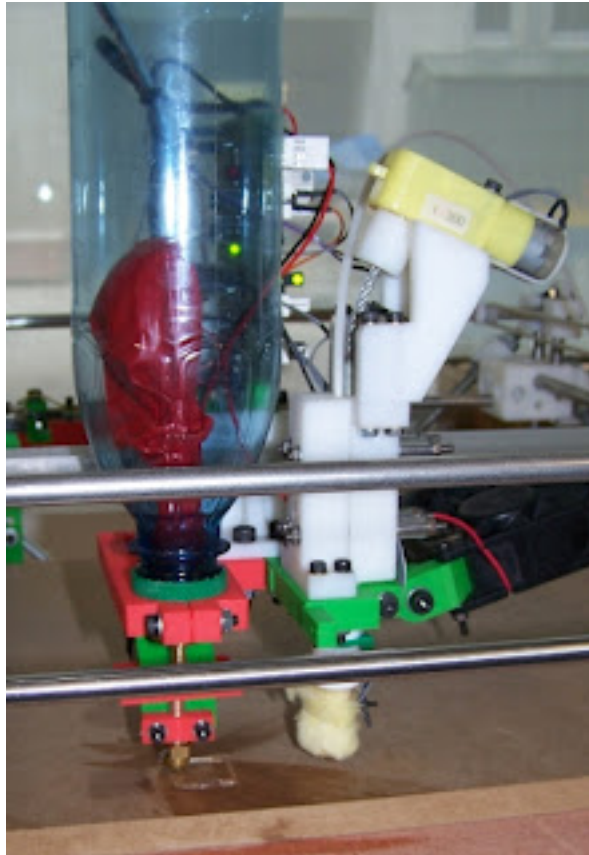

I have got the paste extruder working on RepRap. It consists of a 500 ml fizzy drink bottle containing a balloon that in turn contains the paste. You pressurize the bottle using a bicycle pump, and the flow is controlled by a latching solenoid that clamps onto a soft silicone tube on the way to the nozzle. The clamp is the red rectangular piece hovering over the tube in the picture below (the solenoid is behind the green support). When the red bit moves backwards the flow is shut off.

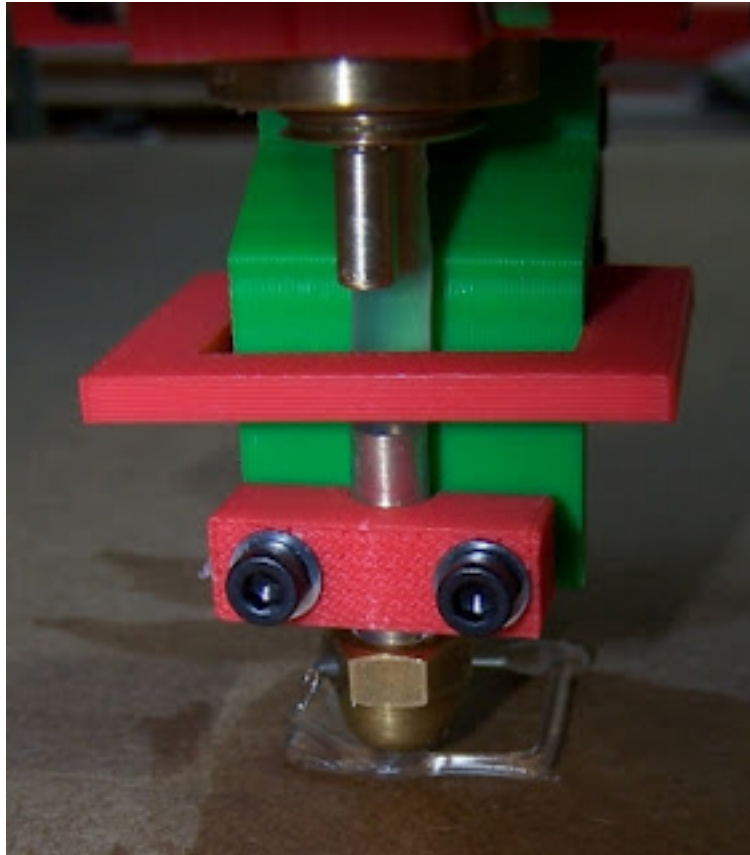

Here is a close-up of it laying down a test square. The material is PolyDiMethylSiloxane (PDMS - silicone bathroom sealant). I had the flow set too high and the movement speed too slow, so it's flooding a bit. But that should be easy to fix.

The controller electronics are really simple - just the standard RepRap controller with slightly modified firmware (which I have just posted in the software repository as `extruder_1`).

The silicone doesn't set if you leave it in the device overnight, except for the bit actually in the silicone tube that forms the valve. I suspect that this is caused by the fact that the materials are the same, and so a little of the catalyst that caused the tube to polymerise when it was originally made is leeching out and setting the working material as well. If I am right, to fix this we just need a soft tube of another material.

When the valve closes, it deposits a splodge of goo as it displaces some material. The tube I used for the valve is 3mm internal diameter, which it doesn't need to be. I'll try and find some of 1mm I.D. That should cut down the closure volume, and hence the problem, dramatically.

This means that we should be able to work with just about any material that is a paste at room temperature. Tomorrow I'll use up another balloon (no expense spared) and try Polyfilla wall-crack filler paste.

Memory hog is bacon

Thursday, 28th June 2007 by Adrian Bowyer

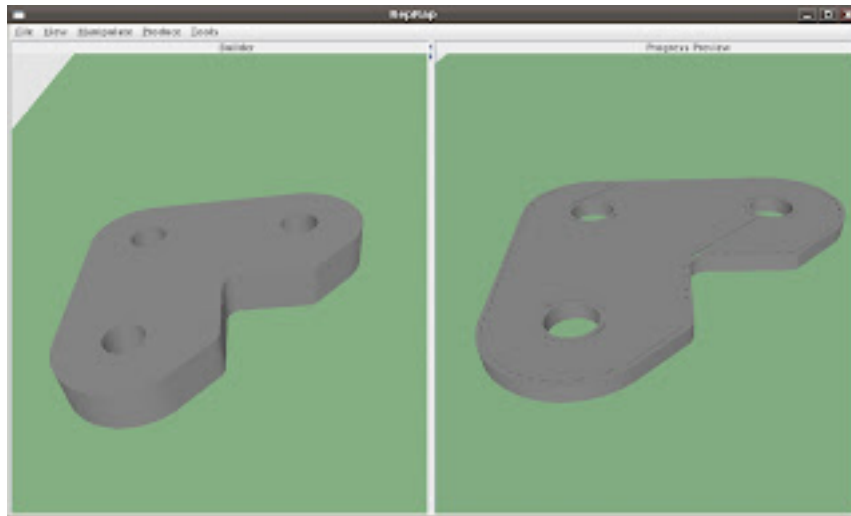

There has been a problem for some time (entirely my fault) with the RepRap simulation window (on the right above). When the machine is building it also does a virtual build in that window, adding a thin rectangular block for each line of polymer laid down.

Of course, for a build of any size, the number of rectangular blocks grows very large, and Java3D has to keep them all in memory. It eventually runs out of space.

But you can only see the last layer and the layer currently under construction. So I have now amended the software so that it keeps just those layers, and throws away all the ones underneath as they go out of sight. It replaces the thrown-away layers with the lower shell of the object taken from the triangles in the STL file. This shell is easy to calculate, as - when a slice is being taken for a layer of the build - the edges in the slice are precisely the lines across the STL triangles needed to make up the top edges of that lower shell.

Filling in the cracks

Friday, 29th June 2007 by Adrian Bowyer

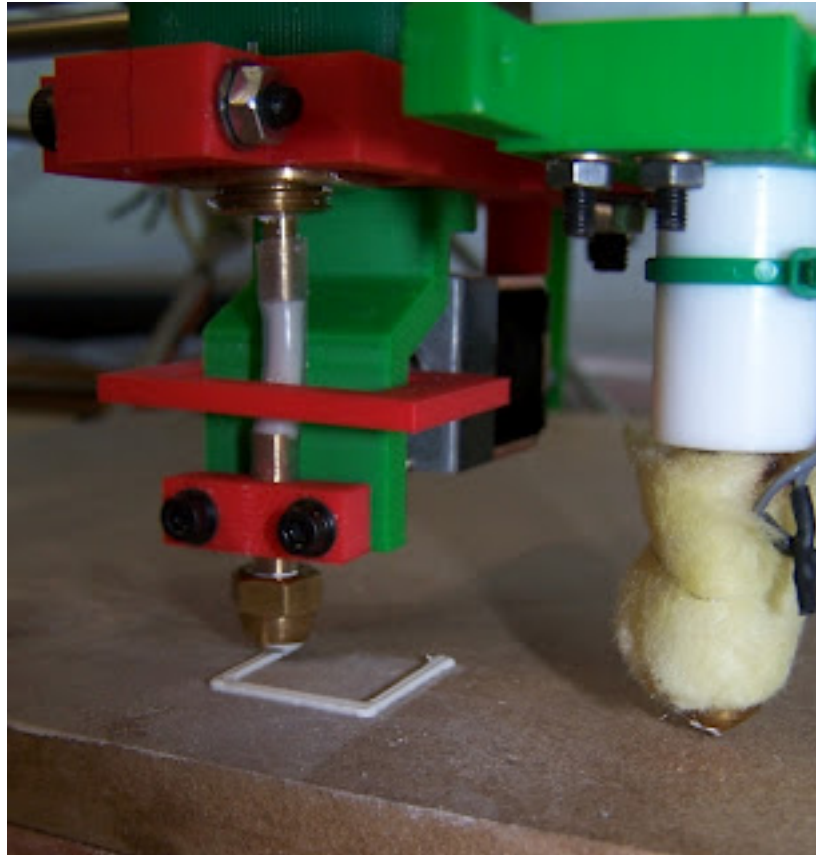

As promised here is the paste extruder working with Polyfilla wall-crack filler paste. As with the silicone yesterday, the flow rate is still a little high (next: try a smaller diameter nozzle), but it works smoothly.

The principle of the device is proved. Now what needs to be done is to improve the design: it's a bit difficult to refill, and that needs to be made better. Also, at its heart, is a turned brass part that I think can be replaced by a rapid prototyped one. The nozzle is a slightly modified version of the one on the polymer extruder, but there is no reason for the two not to be identical.

RepRap Going To O'Reilly OSCON 2007

Friday, 29th June 2007 by Vik Olliver



We're going to O'Reilly OSCON in Portland, Oregon to do a presentation on the RepRap. I'll be there with Suz, rubbing shoulders with the likes of Mark Shuttleworth and Eben Mogen, presenting "Fabricating a Free World" on the Thursday. Hope to see some of you there!

Vik :v)

Darwin's Adventures Down Under

Friday, 6th July 2007 by Vik Olliver

For those of you wondering why I've been so quiet, a couple of things have happened. First, I lost my job because the New Zealand offices closed. Not happy about that. Nice bunch of people and we worked really well as a team. So, jobhunting is now in order.

Also, because there is a limit to how much jobhunting can be done in a day, I have been assembling a Darwin. I've had to stop due to a shortage of M8 threaded rod, and midnight looms...

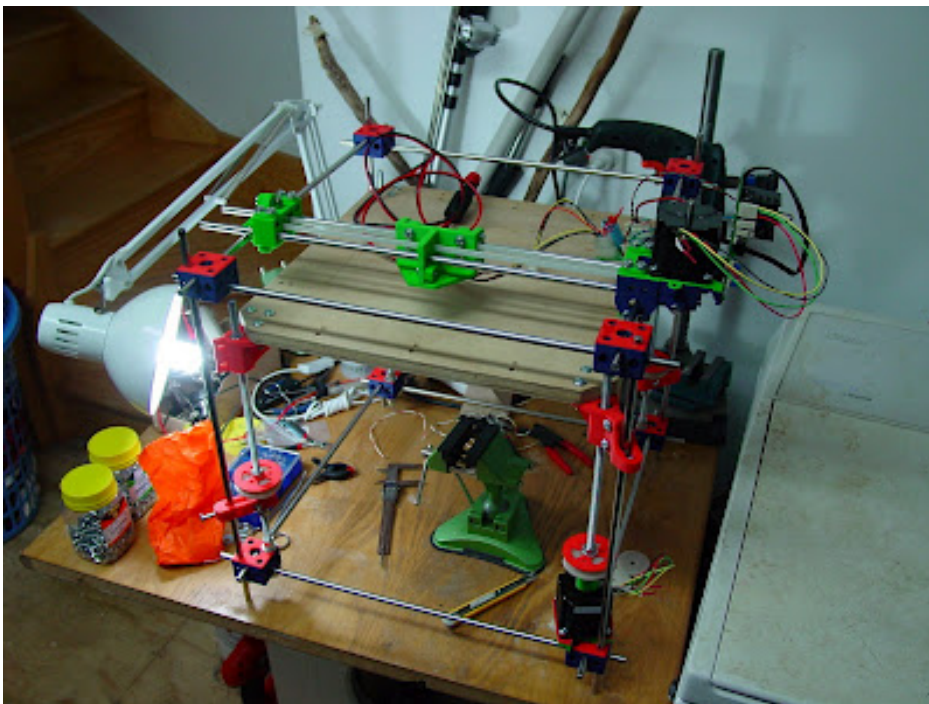

Yes, the bits really are that colourful. Adds a sort of 60's psychedelic feel, I find.

Vik :v)

Mendel Preview

Monday, 16th July 2007 by Adrian Bowyer

We are all working like crazy on RepRap 1.0 "Darwin" of course. But I have an MSc student, Arman Ghandizadehdezfuli, who is looking at Mendel for the future. Here's a video of the prototype extruder changer that he's designed being tested in Darwin. (The slight jerkiness is all from the cheapo webcam software; the actual movements were clean and smooth.)

The idea is to have a row of extruders along one (or more) sides of the machine, and have it pick each up and use it in turn so that many different materials can be incorporated in a single built object.

I had originally thought that each extruder would have its own RepRap controller attached to it. Docking and undocking an extruder would momentarily break, and then re-route, the token ring that allows all the controllers to communicate. But now I think that that would be unreliable. Better to have one controller on the moving carriage, and to connect the drives for the motors and heaters from that to each extruder when it is picked up. The extruder machinery doesn't need clean data during the moment of connection, and so this would be far more robust. Any extruder that needs a controller when it is parked (to keep it at temperature, for example) can have its own controller attached to its docking station that makes contacts in the same way.

Another change will be that the X, Y, and Z flags for the opto endstops will be on each extruder (rather than having just one set on the carriage), so the machine can always zero with precision and get the registration between materials exactly right. The picker-upper grip on the extruder in the carriage is firm, and it doesn't move. But this zeroing scheme would also mean that the grip wouldn't have to grab an extruder in exactly the same place each time.

RepRap Talk Online

Friday, 20th July 2007 by Zach Smith

Recently, I gave a talk at NYLUG about the RepRap project. An mp3 of the speech is now online for anyone who wants to give it a listen. I think it gives a good overview of the project in general and the ideas behind it.

http://www.archive.org/details/NYLUG_2007_07_11_General_Meeting

Where is home?

Friday, 27th July 2007 by eD

This is something that's been on my list for ages... to get some data on Darwin's optoswitches (H21LOI). How good are they at providing a repeatable home position?

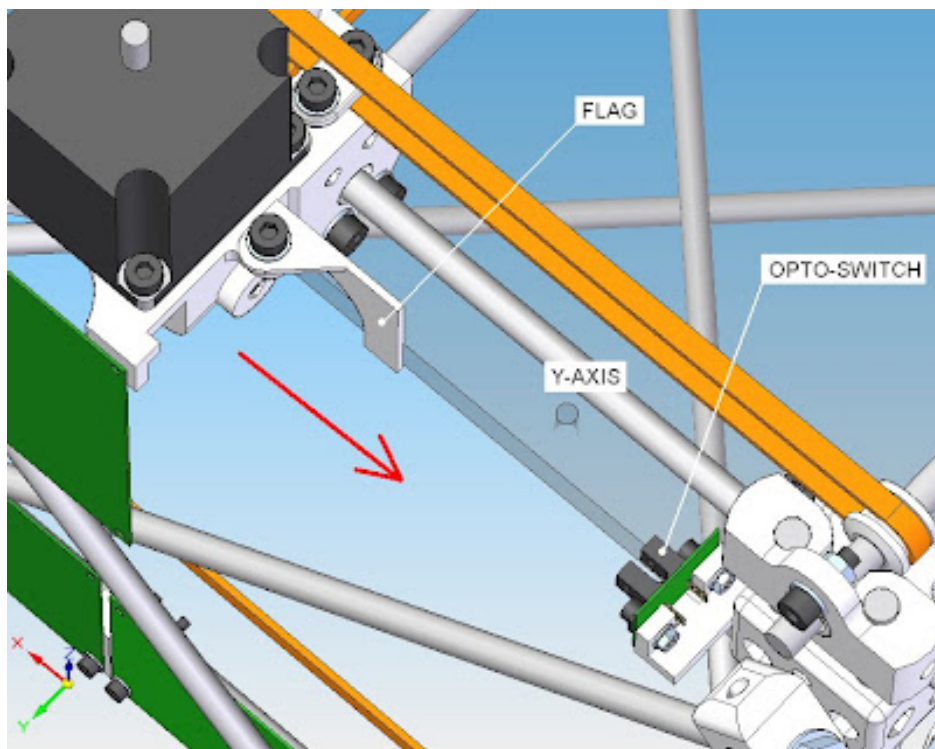

No surprises here - it's all pretty damn accurate. A testament to some solid programming no doubt, nice one ;-). I ran the y-axis back and forwards 10 times, with a caliper strapped on. For both speeds the opto-switch arrangement homed the y-axis to the same motor step 10 out of 10 times. From the results below it's pretty obvious that even greater repeatability might be achieved by slowing the axis down before meeting the end-stop.

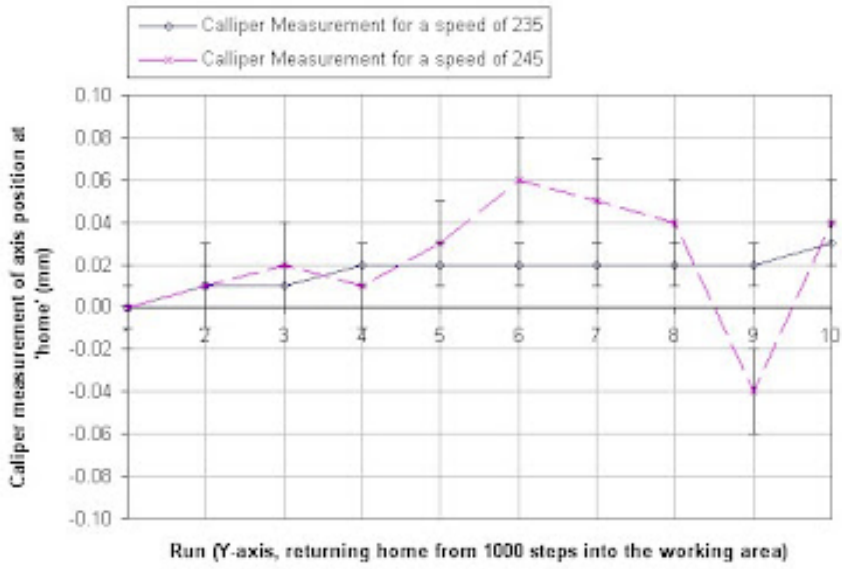

Quick change artist

Tuesday, 7th August 2007 by Adrian Bowyer

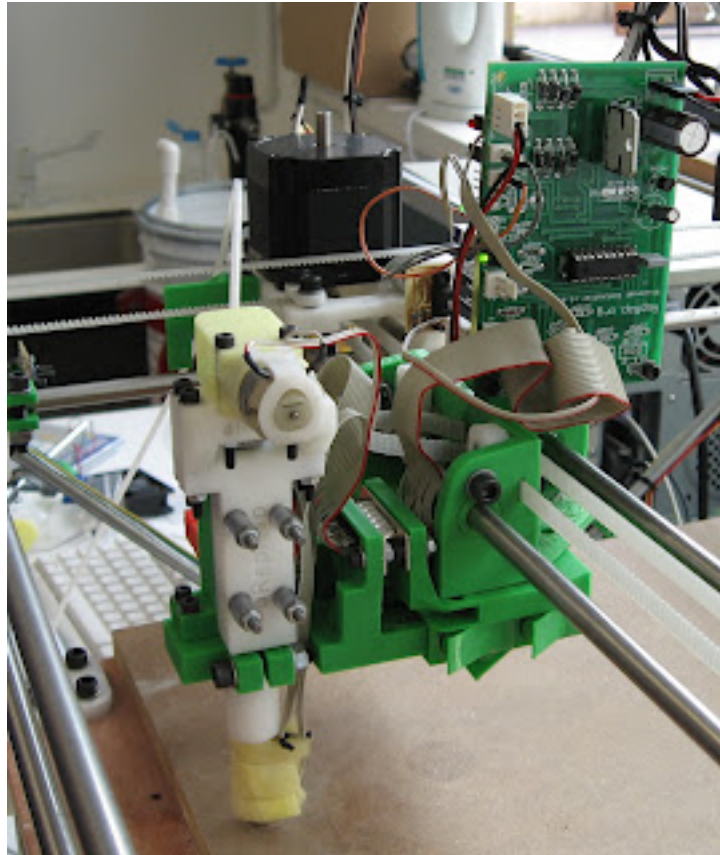

My MSc student Arman has modified his auto-head-changer (which always was for Mendel, not Darwin) to design and make a quick-change plug-unplug mechanism for the Darwin head. You have to take the head off quite often when you're setting up the machine, and also when you're using it. Before, that took about 15 minutes of fiddling with cap screws in hard-to-get-at places. Now it takes a couple of seconds.

The next thing we'll do is to make two heads: one for CAPA and one for HDPE so we can swap them ad-lib for experiments. We'll also put the balloon paste extruder on the same mechanism next to this one for support experiments.

I'm not sure if we want to change the Darwin design at this late stage, but this certainly makes things easy...

Aluminum Extruder Sneak Peek

Tuesday, 14th August 2007 by Zach Smith



If you've followed along in the forums, you know that we have someone CNCing us 10 extruder kits from aluminum. They should be finished shortly, which is very exciting. It will be a big step for the project as a whole to double the number of RepRap extruders that are 'in the wild'.

In the pictures here, I'm assembling a prototype of the extruder. The finished version will only be slightly different, if at all. This extruder feels very strong, and I think once we get these into the hands of some very capable reprappers, we will see some very good, and very exciting results come about.

[More pics on Flickr.](#)

RepRaps by the ton

Friday, 24th August 2007 by Adrian Bowyer

We (and especially Zach) have been devoting quite a bit of thought to how to get people started with RepRaps - when a lot of people have them, then they can all make parts for each other, but when hardly anyone has them then they can't.

In Bath we've had a visiting student over the summer: Nishad Sohoni. He has really come up with something special. Here are the parts for the standard RepRap polymer extruder (quick-swap version) stuck to some sticky tape:

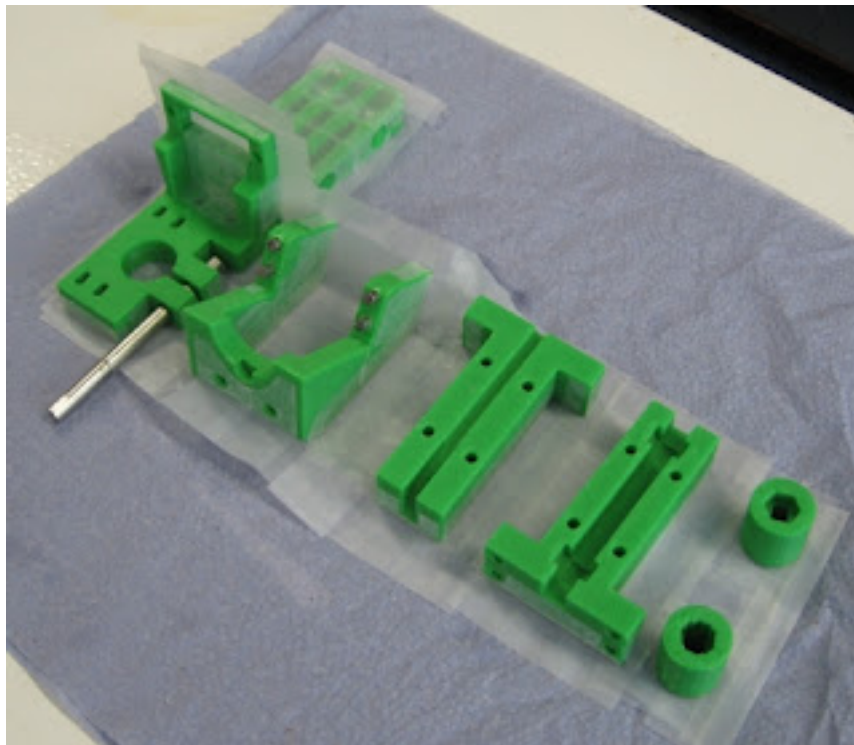

The sticky tape will form a mould split line. Here are the same parts in a box with some risers and runners added:



And here's what you get when you pour silicone rubber in under a vacuum (to eliminate bubbles):

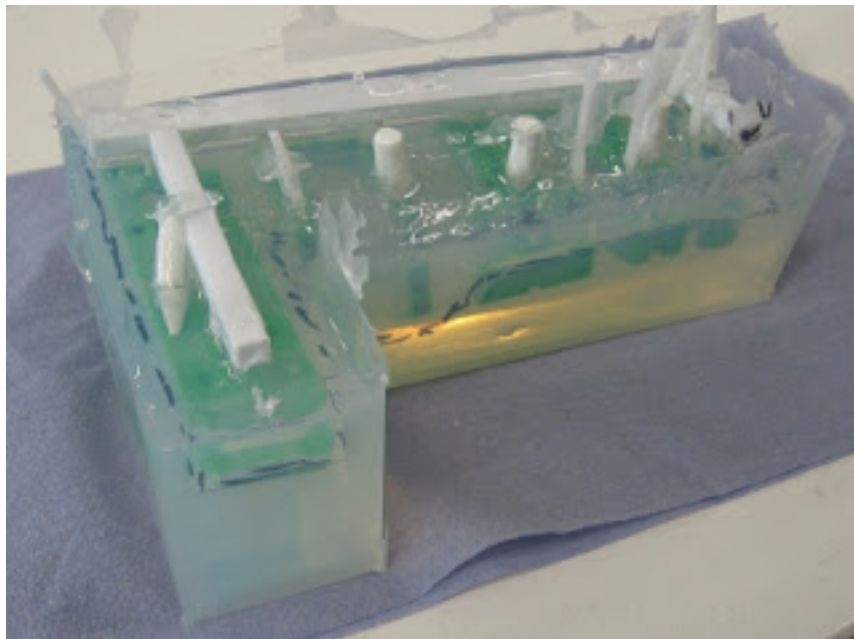

Then Nishad cut the silicone to the split line with a scalpel and took the original parts out:

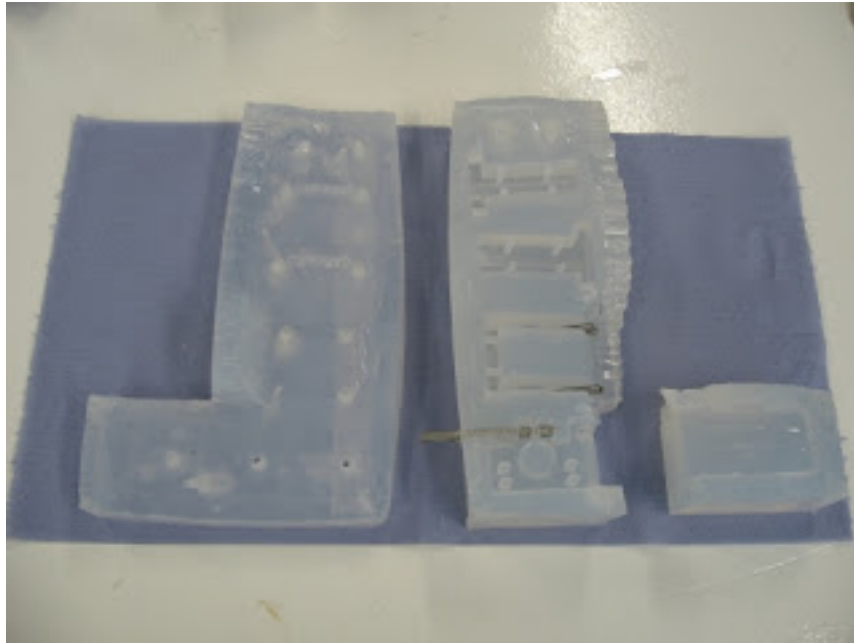

Note the use of a few silver steel rods as cores for deep through-holes in the parts to be made.

Then he put the mould back together with a load of elastic bands and poured in a resin (no vacuum - the resin stays liquid enough for the bubbles to float out of the risers before it sets). The resin we used was the "water-clear polyester casting resin" from [e-bay here](#). Here is the result:

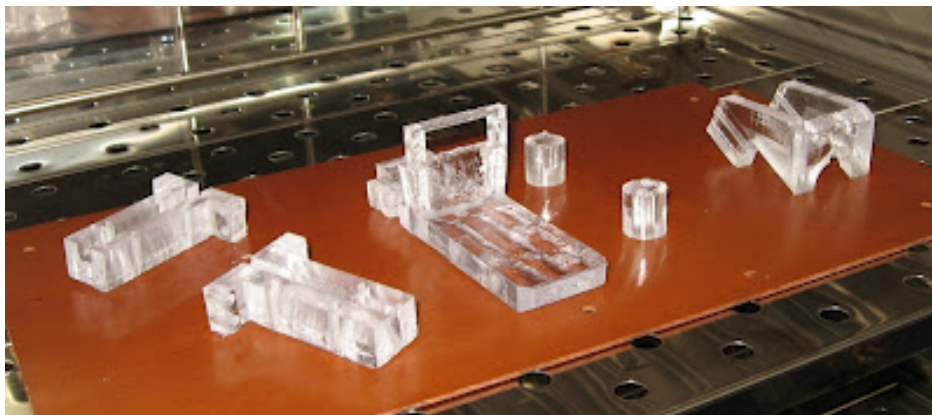

We're obviously going to make it into an extruder and test it...

The neat thing about this process is that, while you need a vacuum chamber to make the original mould, the making of the actual parts can be done in ordinary (well ventilated...) conditions. So we can make moulds and send them to people, who can then make kits for the [RepRap store](#) (or elsewhere).

Honey! I replicated the cat!

Saturday, 25th August 2007 by Vik Olliver

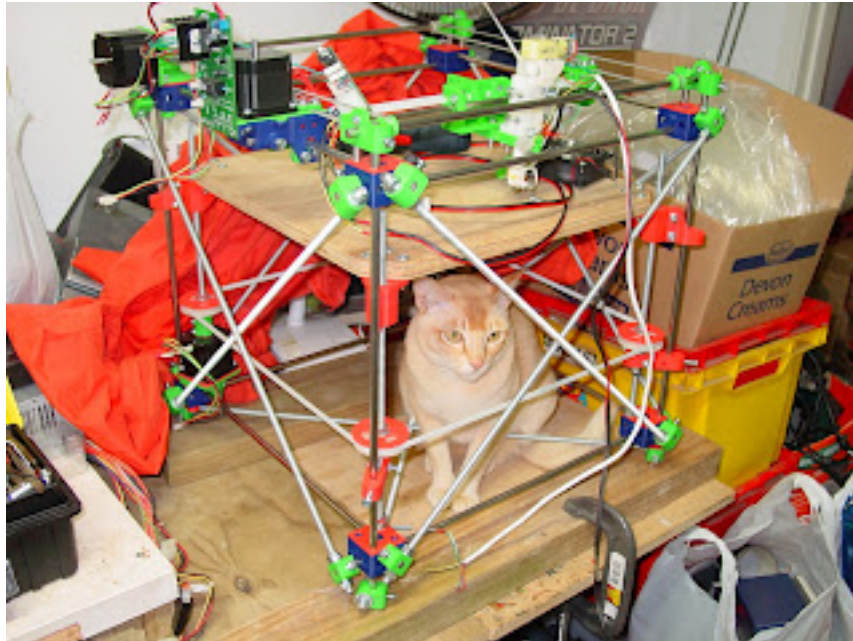

No, not a Catfab 4000, but a humble Darwin taking shape in New Zealand as it is at time of posting - and, of course the ginger cream Burmese 'Chad', who is kindly demonstrating what I have to put up with in my workshop. Thought some readers of the blog might like to know I'm now employed by Catalyst IT, staunch supporters of Open Source in New Zealand, who have kindly made it possible for me to work one day a week on RepRap.

Vik :v)

RepRap progress is faster than a speeding bullet

Tuesday, 28th August 2007 by Adrian Bowyer

At the suggestion of a RepRap website fan I have put together a wiki page showing key items made (almost all by the tireless Vik) as the project has progressed.

The first thing we ever made was just over a year ago. In that intervening year progress has been very rapid indeed, as you can see when it is all gathered together in one place at...

<http://reprap.org/bin/view/Main/ItemsMade>

RepRaps by the ton II

Thursday, 30th August 2007 by Adrian Bowyer

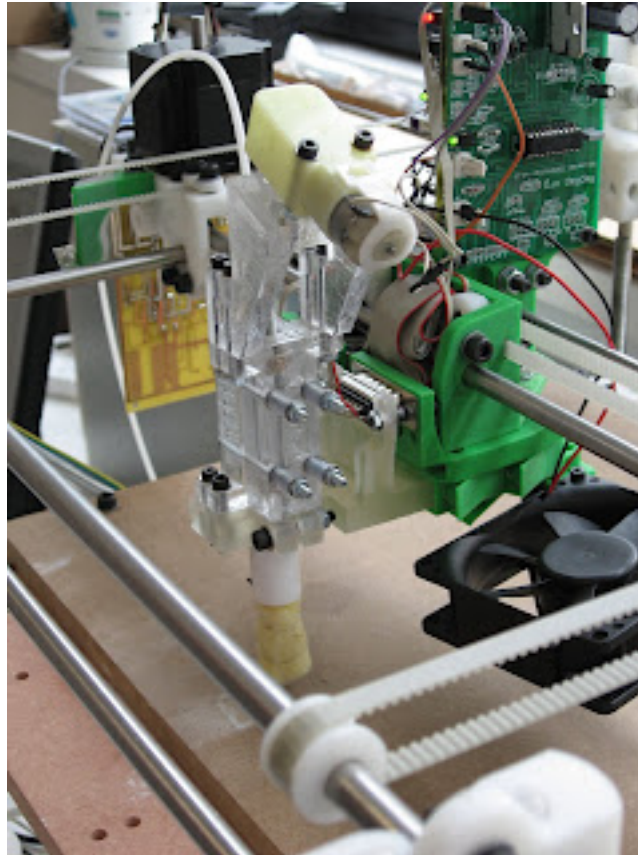

I have now built Nishad's resin-moulded extruder parts (blog 24 August) into an extruder, fitted it in Darwin (thanks to the Really Useful new plug-in extruder swapper), and tested it.

It works perfectly :-)

This gives us a way to make lots of extruder kits for people quickly. Zach is already sorting this out for the [RepRap Research Foundation Online Shop](#). Watch that window!

Volunteers needed!

Saturday, 8th September 2007 by Adrian Bowyer

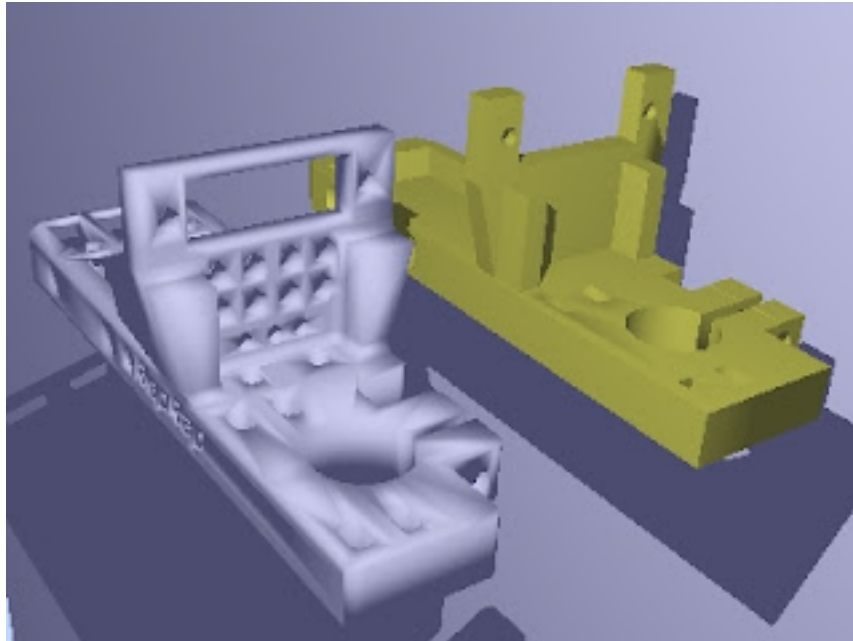

I have just made an Art of Illusion version (right) of the design for the new quick-change extruder from SolidEdge (left - SE can't get its triangle normals right...). I have simplified some features, but it is functionally identical.

The good news is that it was really quick and easy to do. I just imported the STL file out of SE that we used to make it into Aol, coloured it a stand-out colour (unlike the picture above), dragged out a bunch of blocks and cylinderes to the same size (really easy if you zoom in - you can get the accuracy much better than the 0.1 mm or so that is needed), then booleaned them together.

Does anyone want to do this for the parts of the Darwin design on Sourceforge? They're at:

http://sourceforge.net/project/showfiles.php?group_id=159590

(Check out the latest zip file of Cartesian Bot.) All you need is a computer with Art of Illusion running on it.

This would be a real help to the project, as then anyone would be able to edit the Darwin design. There are hints and conventions for using Aol on RepRap at

<http://reprap.org/bin/view/Main/Aol>

If you can help out, send me an e-mail at:

A dot Bowyer at bath dot ac dot uk

with the obvious substitutions.

Thanks!

Extruding from granules

Sunday, 9th September 2007 by Adrian Bowyer

I was so impressed by the EVA-granule extruder made by Timothy Nixon and Adrian Tan of the School of Mechanical Engineering, University of Adelaide, Australia for Fab@Home (see [this link](#)) that I decided to revisit something Forrest and I did almost two years ago (see the [blog for Friday, February 17, 2006](#)), nick extra ideas from the Aussies, and have a go at designing one for RepRap to work with polycaprolactone.

Here it is working:

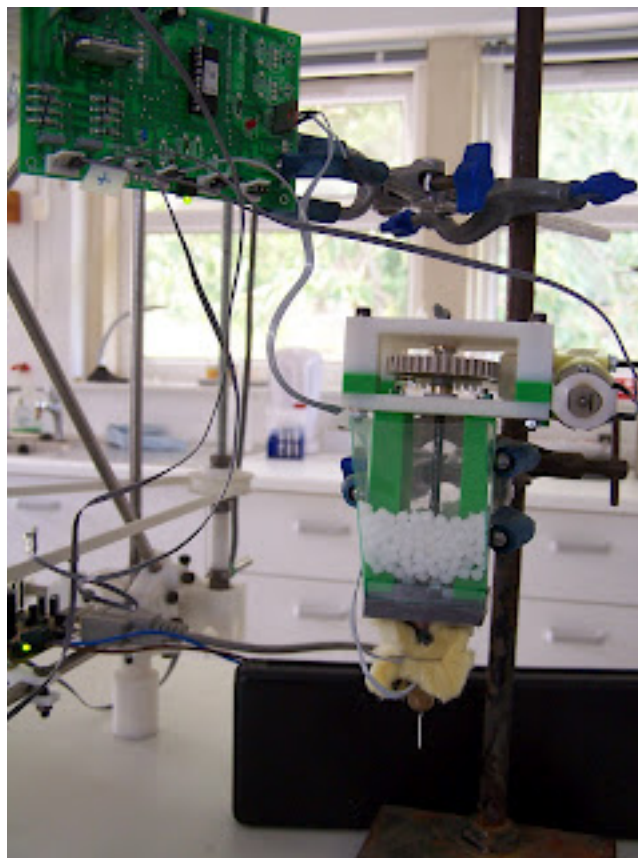

The advantage is, of course, that all thermoplastic polymers are available in bulk at very low cost in granules - it's the standard form. Getting 3mm filament (which is what RepRap currently uses) is not difficult - many companies will do it - but it does add slightly to material costs.

You can find details on the [RepRap wiki here](#). It needs more work, but it'd definitely be a useful addition.

More on the granule extruder

Friday, 14th September 2007 by Adrian Bowyer

The main problem with the extruder was the conduction of heat up the brass and copper screw auger. I decided to make one from a less conductive material - JB-Weld. Here are the initial results. I cast an ordinary 13 mm drill bit in silicone, took it out, then injected mixed JB Weld from the bottom of the cavity with a syringe (to exclude bubbles):



And here it is (with the original drill) after being cut out of the mould:



I probably won't use a drill as the master finally (it's pitch is too coarse, and you have to turn it anti-clockwise, which tends to loosen things), but this shows that you can cast from virtually any helical shape to get what you want.

Darwin's bits

Monday, 17th September 2007 by eD

Had a slow paper-writing day, but on the plus side got a Darwin build finished off the Strat. I thought I'd get creative on a break with all its RP bits ;-)



[Thought: if science is about understanding the universe, is art about understanding the people in it?]

Extruder temperature bug (almost) eliminated

Monday, 17th September 2007 by Adrian Bowyer

For ages (sorry) the extruder's temperature measuring function hasn't been working properly, giving dud low readings intermittently.

I spent the weekend working on the code and have improved both the Java end and the PIC C end. (I have updated both in the svn [trunk](#) and also updated Simon's [autoconf-firmware branch](#)).

Here's a summary of what I've done:

JAVA:

The Java now takes a majority vote between the last three temperature measurements; this reduces the impact of isolated dud measurements (the temperature can never really change very fast, because of thermal inertia).

PIC C:

The PIC C code now detects when the capacitor charge/discharge timings are interrupted and discards such measurements, only keeping clean ones. Unfortunately, with largish capacitors, the measurements are always interrupted because of the times taken to charge and discharge, so this means reducing the capacitor otherwise one never gets a reading... For the standard thermistor (beta = 3480; Rz = 29K) this means a capacitor of 10nF. I have modified the [calculator in the wiki](#) to put in a fudge factor to give this and have changed the extruder controller PCB wiki page to say this, but more thought there is needed.

I have reduced the frequency of the heater PWM interrupts by reducing the value of HEATER_PWM_PERIOD from 255 to 253 'to calm things down'.

I have set the main loop so that it doesn't call the temperature measuring function each time round, as that used to mean that the PIC spent all its time in that function, making large the probability that it would be interrupted and cause trouble*. The heater pwm function now sets a flag, and the temperature measurement function just gets called once after that flag is set. (Having the function instead called as a result of the heater pwm interrupt would cause further trouble, I suspect, so I didn't do that, even though it's more obvious.) This means that the extruder PIC spends most of its time spinning in its main loop waiting for something to happen.

*Actually this is a statistically spurious argument: if interrupts occur in a Poisson distribution (which they don't, but never mind) then the function is just as likely to be interrupted, but any given interrupt is less likely to interrupt it. As it is, interrupts are quasi-regular, which has the same effect.

But anyway it seems to work better...

RESULTS:

All this seems to make the temperature readings a lot more stable. But you still get the occasional dud. I suspect that this is a timing issue between my majority-of-three vote in the Java and the interrupt rate in the PIC. The Java is taking its readings too rapidly - more experiments will be done...

The much-reduced capacitor value means that the temperature auto-ranging runs vRefFactor up to 15, where it more-or-less stays. This is probably a bad thing - more experiments will be done...

PowerComms v1.3.0 Beta

Tuesday, 18th September 2007 by Zach Smith

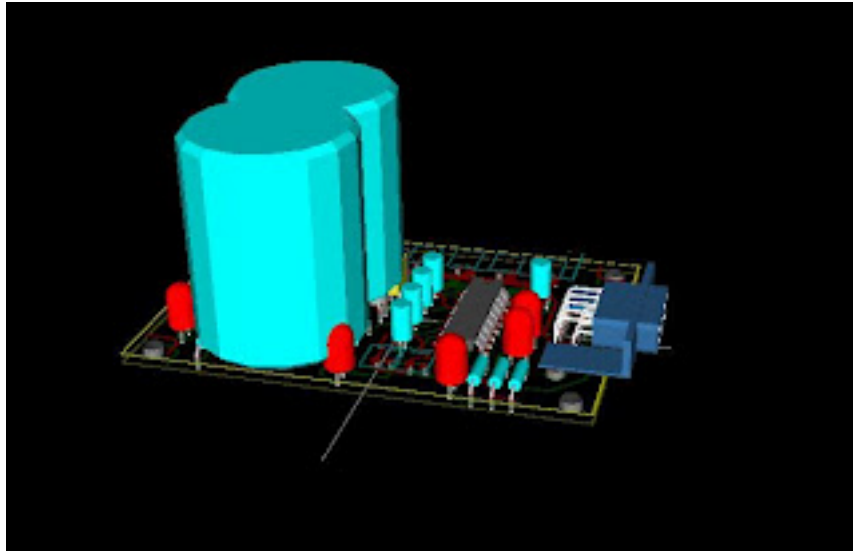

We've been working on the design for the PowerComms v1.3.0 board for a few weeks now. Once the design was to a stable state, the RRRF ordered a small batch of boards from our PCB house. We got 20 boards back, and I'd like to offer these boards (for free!!!) to people interested in helping out with the project.

These are only the PCB's, and you'll have to pay for shipping, as well as the components to put in them, but hey... you're getting a free PCB!!

For more information, check out the [RRRF store detail page](#).

If you want one, simply buy it from the store. We hope that you contribute back to the project with build pictures, documentation, and by testing. You're not required to, but we'd sure as heck appreciate it.

Keep in mind that this is a beta version of the board, and we make even fewer guarantees than normal about it working. (Hint: we make no guarantees about anything, hehe.)

Trivial Update Post: Opto Endstop Docs

Wednesday, 19th September 2007 by Zach Smith

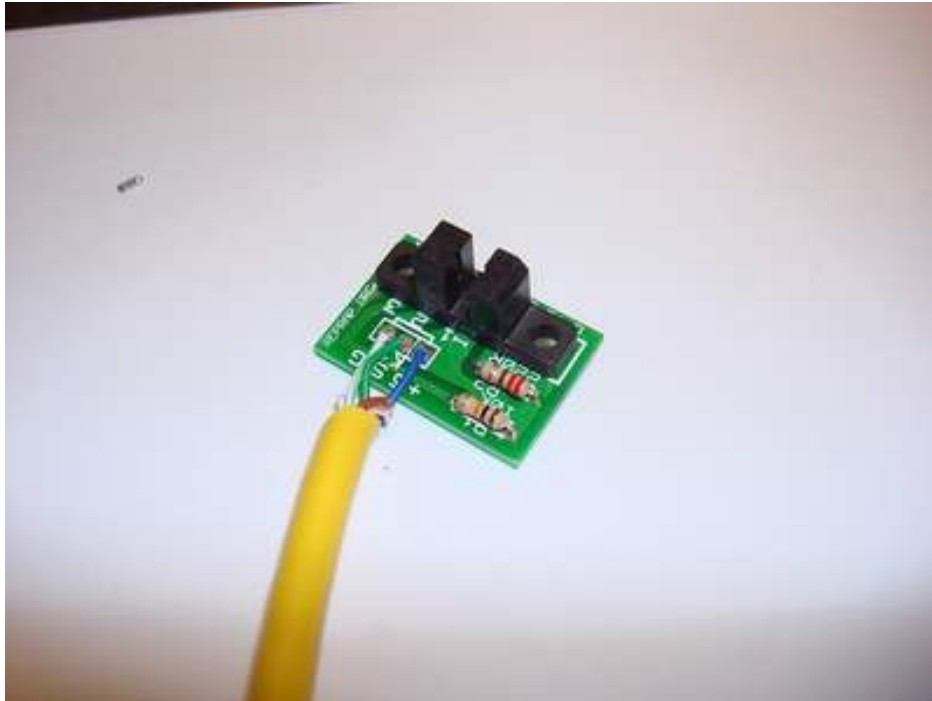

Some have complained that the posts here are somewhat sporadic and they'd like to read more, and I agree with them. It can give the illusion that we aren't working very hard, when in fact we are working very hard on RepRap. So hard that sometimes we don't have time to post on the blog. We're going to try and change that by ideally posting once a day with something that has changed, or been worked on.

Today, I updated the [Opto Endstop documentation page](#). It's almost complete, I just need to take a couple more pictures, and write up some testing info to go along with it. It's a pretty basic page, but now it is much nicer and up to date with the current project status.

We Strive To Improve...

Thursday, 20th September 2007 by Vik Olliver

Here's an idea or 3 I've been kicking around to improve the Darwin design. Maybe they'll have to wait for Mendel but here goes:

1. Y Belt gear to outside

Move the Y belt gear furthest from the Y motor to the other side of the Y axis bearing. This probably means mounting the Y belt clamps on the X axis square jig, but avoids filing that long flat - the gear now just slips on the end.

2. Z motor on top

Move the Z motor to the diametrically opposite corner and take it outside the build area. We gain another 60mm of build height - or save 700mm of steel rod & studding. Forrest suggests we also use the shaft coming out the front, not the back.

3. Beaded belt for belt drive.

The right toothed belt is hard to source and expensive. We might be able to use the sort of stuff used for window blinds and securing vicious attack biros in the bank's foyer. Some testing will be needed, as will new methods of splicing the stuff. Here's an industrial supplier: http://www.raymortool.com/Gen_Info.html

Right, enough brainstorm. Back to testing the new extruder temperature code.

Vik :v)

Waitakere Darwin 1.0 Printing in PLA

Sunday, 23rd September 2007 by Vik Olliver



I've got my Darwin printing in PLA. I had to fiddle the software a bit - reinstate Z-axis speed, and add some bits to ignore ludicrous temperature values.

Hardware required more fiddling: I fitted a fan over the extruder motor to keep it cool as PLA needs a lot of driving. I used a half-round file to sharpen up the thread on the extruder drive, and I've added the dangly filament holder.

I tried doing another PLA flask, but the extruder jammed after 5 layers. I think the bearings are rotating and digging in to the filament. Might need to make new ones.

Vik :v)

Moulding RepRaps

Monday, 24th September 2007 by Adrian Bowyer

More news on moulding the parts of RepRap to get the first machines out there fast: I just made the tie bracket (one of the parts of Darwin that you need a lot of for one machine):

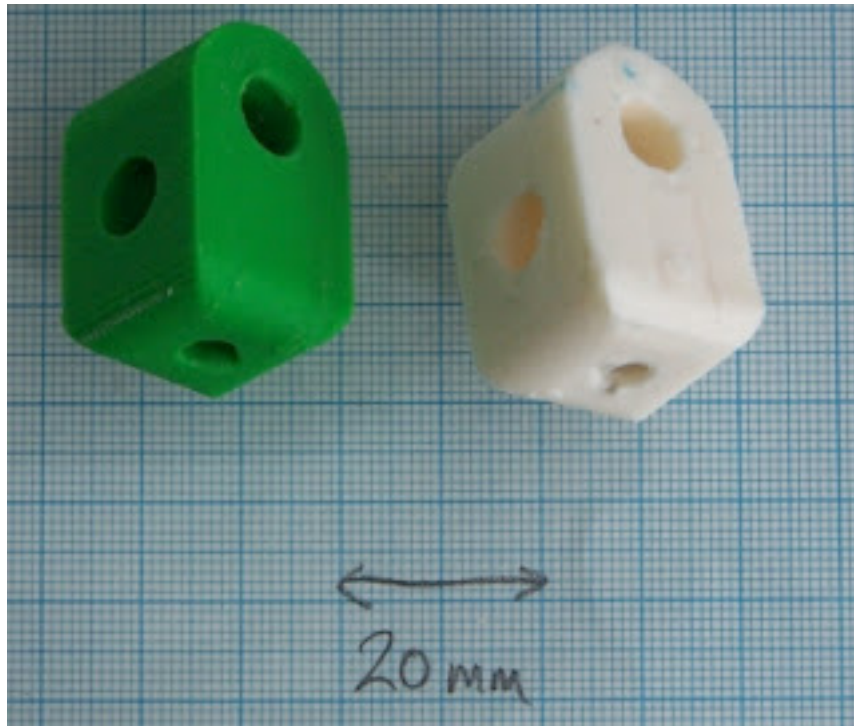

On the left is the original RP part, on the right is the moulded one. What you can't really see here are the complicated internal cavities.

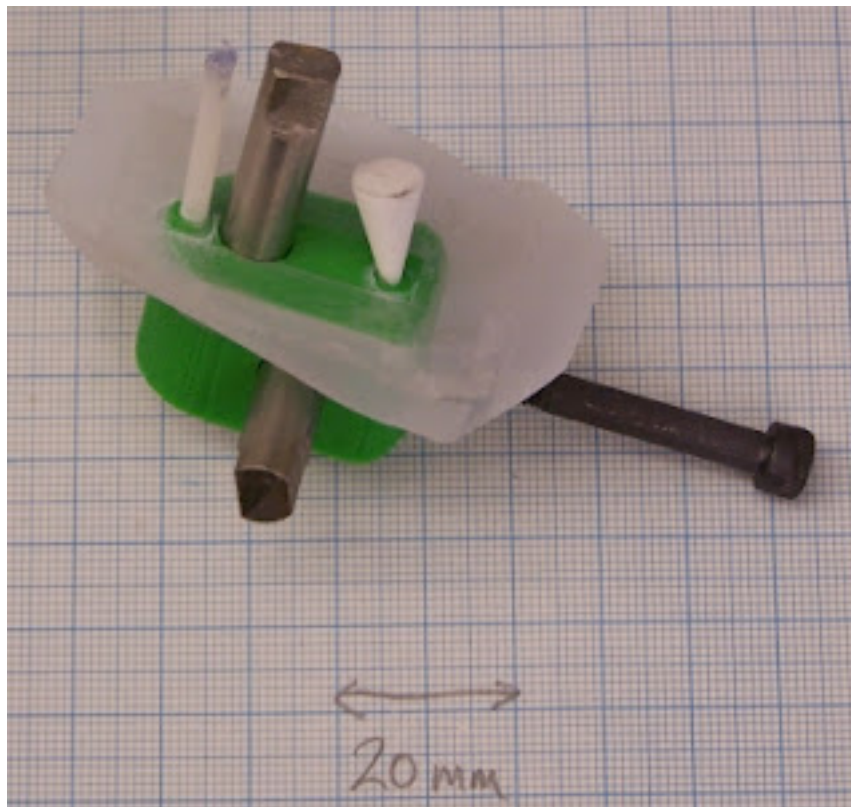

I started by super-gluing on a gate (white cone - plastic rod through a pencil sharpener) and a riser (thin white rod) to the original part. Then I added sticky tape to define a mould split line and put two 8mm rods through the holes. I then put an M5 bolt through an internal trapped nut to hold the rods.

I put the lot in a plastic box and poured in Viscolo 22 liquid silicone from Tomps. I should say immediately that this is a fantastic moulding compound. It is very inviscid when pouring, which means that bubbles come out so you don't need to do the moulding in a vacuum. If only it were transparent (so you could see the tape mould split to cut to it after it's set) it'd be perfect.

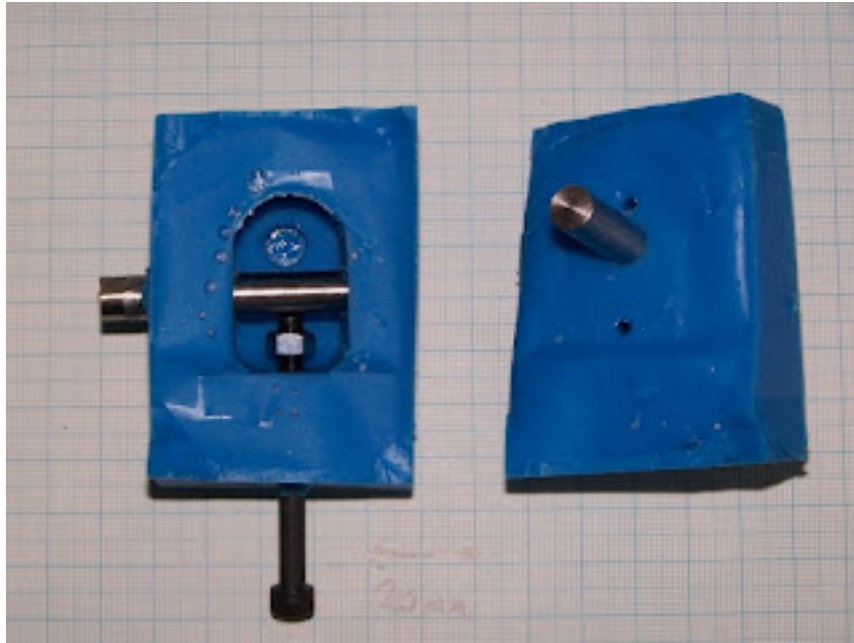

Here are the resulting mould cut to the split and with the rods and M5 bolt put back in. Note the nut floating on the bolt - that's going to get incorporated in the casting and become a trapped nut. I covered the rods and the bolt (but not the nut) in a thin film of silicone grease. Then I poured the resin, which was Tomps polyurethane fast-cast.

Here it is solidifying:

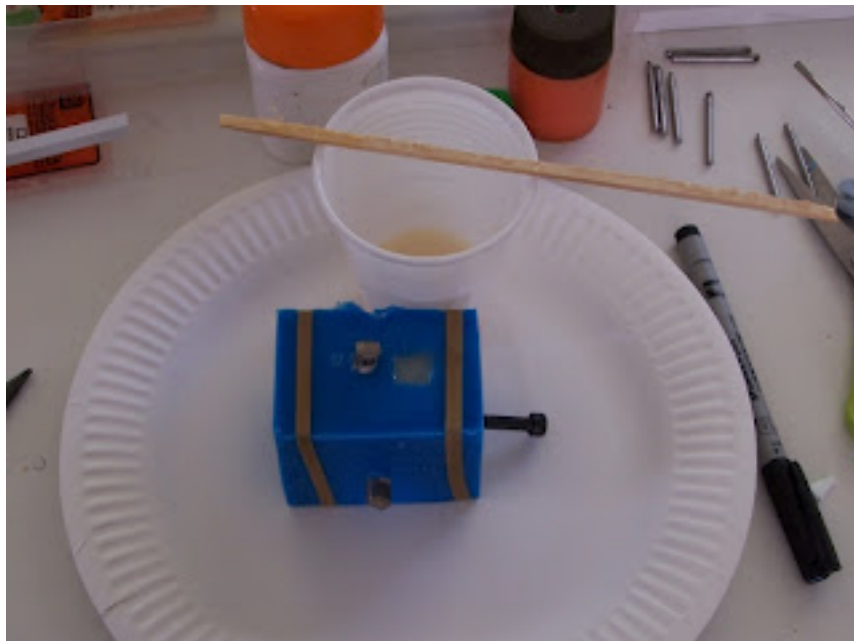

I simply cannot rave enough about this resin... It is the consistency of milk when mixed, so it pours really easily, and it sets in half an hour at room temperature. It is just a perfect material.

The result was a solid workable bracket, with an embedded nut and all the internal cavities needed.

Object file release updates

Wednesday, 26th September 2007 by eD

I've modded the release packages for the Cartesian bot and the Mk2 polymer extruder to cater for the new quickfit interface, and some minor revisions. The packages are available on [SourceForge](#). Mods as follows:

Cartesian Bot 1.0.2, new STL's:

Z-toothed-pulley-rim.stl

Z-opto-flag.stl

Y-motor-coupling.stl

X-PCB-bracket.stl

X-carriage.STL

Extruder-quickfit-latch.STL

Extruder-quickfit-dock.STL

Bearing-insert-360-run.stl

Diagonal-tie-bracket.stl

Bearing-insert-180-Z.stl

Bearing-insert-180-X.stl

Thermoplast Extruder 1.0.1, new STL's:

quickfit-clamp.stl

Smokin' The Gear

Wednesday, 26th September 2007 by Vik Olliver

I darned well blew another extruder motor. Even though it had a nice CPU fan on it to cool it down, it still popped. I am pushing PLA here, not the standard CAPA filament, so the equipment abuse factor is fairly high.

Fortunately, Forrest has been kind enough to supply me with several motors from his collection, so I'll strap in a beefier one and see if I can get pumping the PLA again.

I've squished more CAPA over the bearings to hold them in place, and at least they don't seem to be twisting around into the filament any more. I am generating quite a bit of PLA dust though!

Vik :v)

Running smoothly - for 5 minutes

Thursday, 27th September 2007 by Vik Olliver

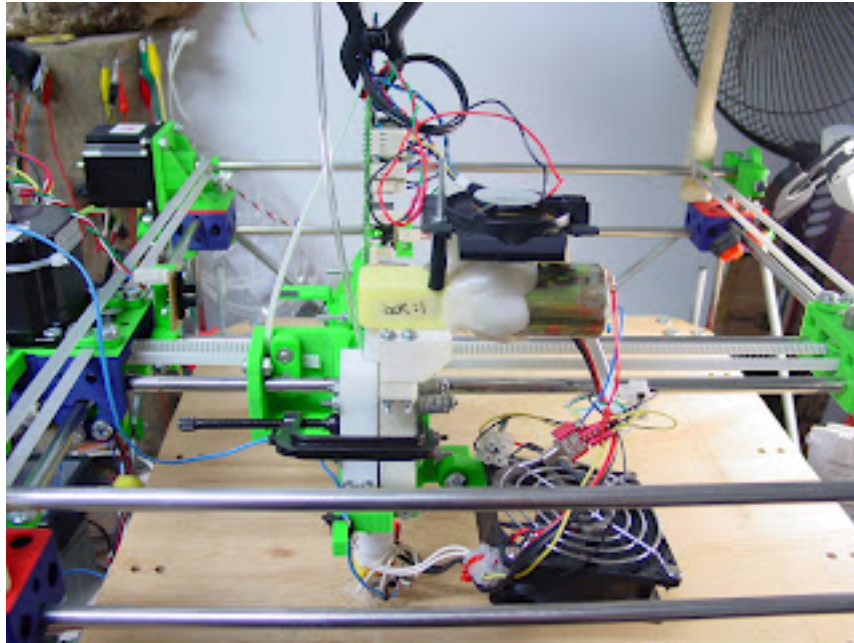

I think I've got the PLA extrusion fixed. This is my setup, complete with little G-clamp to add additional pressure. I'm using a massive "that's not a motor - this is a motor!" 12V motor frankensteined on to the standard gearbox using CAPA. I left the fan from the little motor there in case the CAPA decided to get warm...

The extruder now purrs like a kitten with no feed issues whatsoever. The extra switch (red DPDT above large fan) is so I can switch the thermistor between the controller and my meter when calibrating.

But.

My extruder heater just went orange and popped - just after I sent my spare to Adrian! No, Adrian, don't rush it back - I need to build another anyway :) Still, it goes no more. Fair enough; it's an elderly specimen and I can do better. I also know to use a 20% lower resistance than specified for the standard extruder heater, as it won't quite work with PLA on a real 12V supply (it needs 14V).

A small bit of background: It's made from "pelican wire" without secondary insulation, if I recall correctly. I checked with a multimeter and it's not a short to the barrel. Might have to go back to BBQ paint and standard wire for PLA.

Vik :v)

The extruder lives - again

Friday, 28th September 2007 by Vik Olliver



And the Darwin produces a minimug; well, nearly. It's not watertight and has a lot of stringy bits in it. Not far off though. The Z axis is starting to smooth out a bit and the extruder is behaving very well now, if a little slower than I'd hoped.

The blown nichrome was right on the surface where the wire entered the plaster jacket. I suspect metal fatigue. Still, I dug out a few mm of nichrome (the 'pelican' insulation had disintegrated near the break) from the jacket and fired it up again. Heh, not forgetting to do the PTFE clamp back up...

[Breaking News: Watertight minimug now exists. Pictures of traditional toasting tomorrow.]

Must also pay some attention to family this weekend.

Vik :v)

Cheers! Another Minimug Emerges.

Sunday, 30th September 2007 by Vik Olliver



Here's me with the finished PLA minimug, and the Darwin that made it. Oh, and a rather fine bottle of Ballantine's 30 year old scotch. There now appear to be two 1.0 Darwin RepRap's in existence.

I've started trying to make RepRap parts with it, but being single-material it can't make them all just yet.

Vik :v)

RepRaps by the ton III

Wednesday, 3rd October 2007 by Adrian Bowyer



As all you avid RRblog followers know, one of the things we've been doing is looking into using soft moulding to allow us to make RepRap components from the rapid-prototyped masters to sell in the RepRap online shop as a stopgap until there are enough RepRap machines out there to be making stuff directly.

I have now put complete instructions on how to do this [on the wiki here](#).

PICs Reading USB Drives

Thursday, 4th October 2007 by Vik Olliver

We've kicked around the idea of a RepRap being able to store parts on a USB drive so that no PC is actually needed to print things out. It's a little esoteric and not a near-future priority, but for those into such things this article describes how a PIC can be interfaced to a USB Flash drive using a VNC1L Vinculum controller IC:

<http://dataweek.co.za/news.aspx?pkINewsId=26407&pkICategoryID=34>

Vik :v)

Tha intakes are clogged wi' dust, Capt'n

Saturday, 6th October 2007 by Vik Olliver

The standard CAPA filament is reasonably pliable and doesn't form dust. PLA, on the other hand does. The reason for a recent extruder jam was that the bearings had filled with PLA dust. I wondered if we might open up the extruder a little behind the screw drive to let dust and debris fall out?

Update: Dust prevented and feed improved by lightly lubricating the filament with SAE 30 oil.

Vik :v)

RepRap goes to MIT

Wednesday, 10th October 2007 by Adrian Bowyer

Zach, Sebastien, Ed and I had a paper on RepRap accepted by the 2007 Mass Customization and Personalization Conference at MIT. Ed and I registered for the conference and we decided to bring Darwin along to show as well as presenting our paper.

After no trouble at all with airport baggage security at Bristol International (thanks to them for being tech savvy and non-jobsworth), I got the machine in bits in among my socks to Boston. Here's Ed putting it together in my hotel room:



And here's us with Darwin building the famous Vik minimug in the conference lobby in a pic taken by Zach's friend Caitlin:



As you can see only one of us fully realizes the terrible gravity of the situation...

For those who prefer mixers

Friday, 12th October 2007 by Vik Olliver

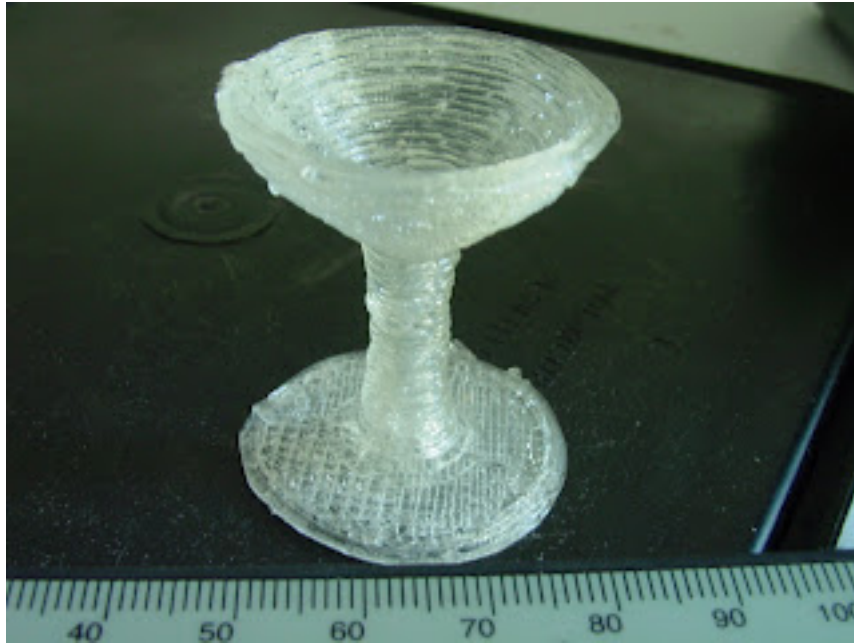

One martini glass. Now the rerap's head doesn't bob around, I can make some surprisingly delicate structures. This object was printed without any forced cooling - or cooling delays - at all.

Yes, it's watertight.

Vik :v)

First RepRap'd Z-Axis Pulley Rim

Friday, 12th October 2007 by Vik Olliver



Here's a photo of the Z-axis pulley rim that fits on top of the Z axis gear. I've pulled off all the stringy bits and reamed the holes out with just a drill bit held in my bare hand to clear the thin cruddy bits out. As you can see, it's not too shabby.

I've tried printing a corner bracket and got about 70% the way through before a new and unexpected software state was encountered. Ahem, cough. Beyond my ken, but Adrian will be back soon...

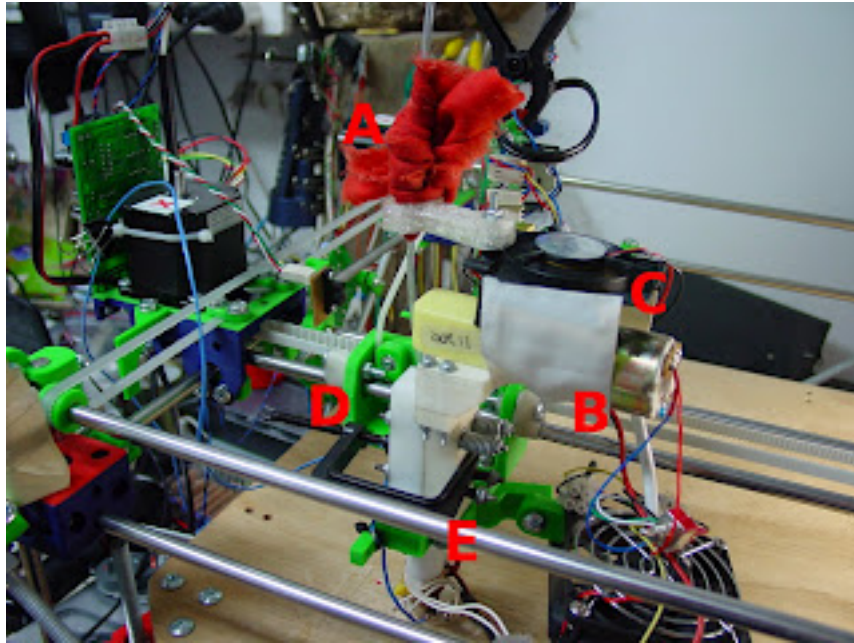

Anyway, here are the modifications I did to the Darwin to get PLA coming out.

- A. Oily rag in holder to lubricate filament.
- B. Large 12V motor to push filament through.
- C. Fan to stop polymorph motor holder melting.
- D. Polymorph saddles to stop excessive rotation of carriage.
- E. Clamp to apply extra pressure to filament.
- X. That's a label so I remember which one is the X-axis motor...

You can't see it in this photo, but also I flopped the extruder "umbilical cord" over to the side so that it doesn't tangle with the filament feed.

Vik :v)

Having a little wine

Wednesday, 17th October 2007 by Vik Olliver



Continuing on the beverage container theme, we now have a wine glass. Actually, we now have two. Measuring the second shows a 72.9mm height, compared with the expected 70mm so I have tweaked the Z scaling accordingly.

Why the beverage glass fetish? Well, apart from being an old soak, they're not very taxing on the construction algorithm and it's obvious when they are either not watertight or asymmetrical. Also, I wanted to do overhangs, and a thin-stemmed glass looked to be a good demonstration of the ability of the RepRap to do overhangs.

Vik :v)

X-Idler Bracket Printed

Friday, 19th October 2007 by Vik Olliver

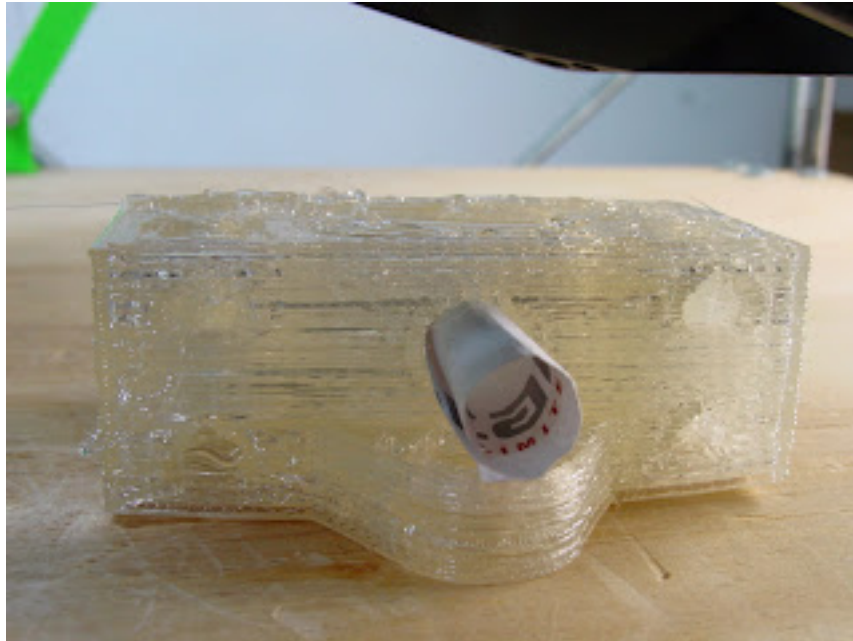

Here's the pretty side of 11 1/2 hours of Reprapping. You can see that the PLA started to curl - I'm not cooling layers here so I might have to get that working again.

The paper tube is because I realised half way through that the hole for the axle was not Reprap-friendly as it was not pointed. So I quickly rolled up a bit of the nearest thing to hand (a Catalyst compliments slip as it happens) and poked it in the 3/4 complete hole. I had to roll it around a bit of 6mm rod as a guide to slip it in.

The Reprap-friendly hole shape is quite clear in the top right corner. The loops on the left edge are caused by the nozzle erroneously seeking warmth in its corner due to temperature reading bugs.

Anyway, I'll tidy it up and take some pretty photos tomorrow. Kinda tired right now.

Vik :v)

X-Idler Bracket Continued

Saturday, 20th October 2007 by Vik Olliver

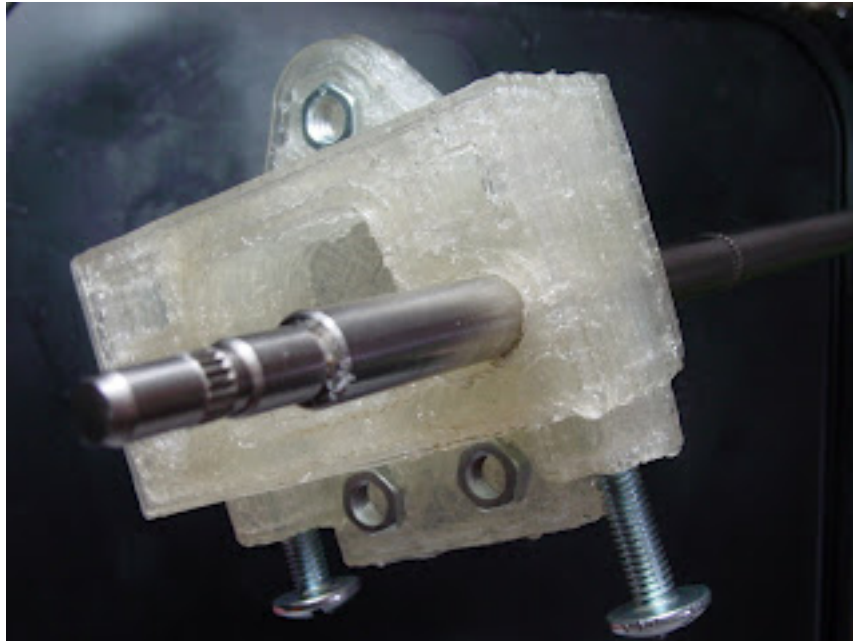

OK, here's the tidied up version. I had to ream out the vertical holes by hand, the horizontal holes were fine and just needed de-stringing. I have seen how threads of molten plastic climb up the curved surface of an acorn nut nozzle and I'm modifying one to see if I can reduce the stringing. The holes in general were smeared somewhat, mostly due to a soon-to-be-fixed software bug which resulted in the extruder not being turned off at appropriate moments.

In the previous post, you can see the part starting to curl like a king-size mattress being stuffed into a queen-size fitted sheet. The curl is not very pronounced, but did distort the 8mm holes making the insertion of an 8mm rod very tight indeed - you can see shavings on the end closest to the camera. The nuts fitted into the rectangular slots at the top without a problem. The other holes were a little tight and required gentle persuasion to drive the nuts home - a bolt and very large washer was used to winch them in.

What didn't fit was the nut down the channel in the 8mm hole. My reaming didn't clean that out enough and I had to resort to a dremmel tool.

It near enough works and I'll be building it into a Reprap as soon as I can.

I'm extruding in 0.55mm layers, 1.62mm outline size and 0.73mm infill size from a 0.86mm nozzle. Max x-y movement speed is set to 238. This gives fat outlines, but because of the jerky movement between points by the head, curved lines are fatter than straight lines and the slow speed minimises the difference in width.

A very respectable 0.5mm width wall was printed by mistake during a buggy phase of this printout when the nozzle moved without being turned off, but this is good as it shows what the hardware is actually capable of - even with a 0.86mm nozzle.

Vik :v)

X-axis idler assembly in PLA

Sunday, 21st October 2007 by Vik Olliver



Just for kicks, I printed out a couple of belt clamps and a pulley. Oh, and about 95% of an X-axis restraint (software crash, blue-tinged air etc.) but it looks like we're on our way to starting an X-axis here.

I've switched to a 0.78mm nozzle now, and the new shape is an improvement in preventing strings - or at least shedding them quickly - but not much so. Also having a few problems with PLA not adhering to my new machine bed so well. Hopefully a good wipe-down with acetone and a scrape with a wire brush (for the Reprap, not me) will improve things.

Vik :v)

The latest from Adrian

Tuesday, 23rd October 2007 by Forrest Higgs

The Canadian Broadcasting Corporation did an interview with Adrian over a Skype connection.

http://www.cbc.ca/spark/blog/2007/10/interview_with_adrian_bowyer_3.html

The voice quality was exquisite, though there were a couple of drop-outs. As always, Adrian gives a very good interview on RepRap.

[No Title]

Tuesday, 23rd October 2007 by Adrian Bowyer

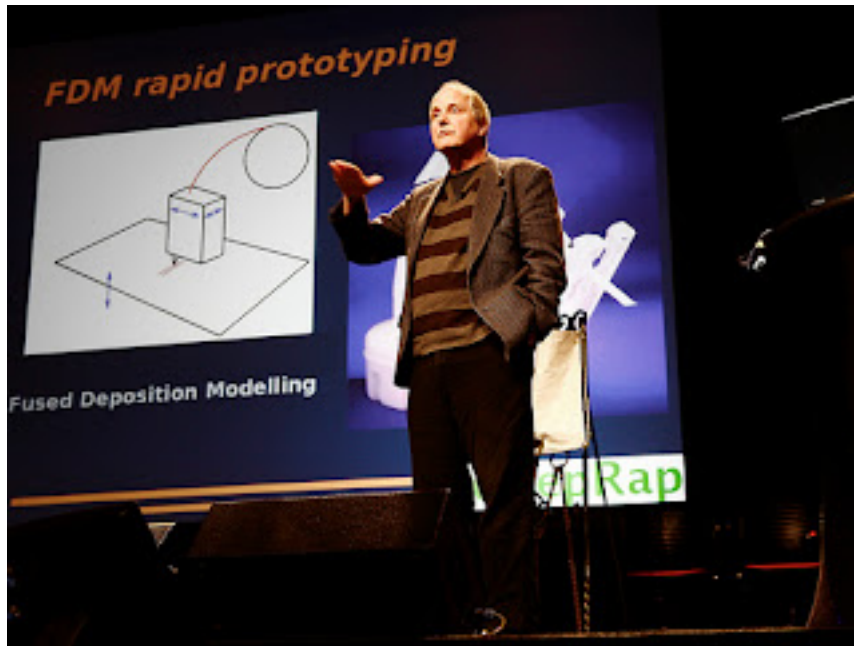

Here is RepRap (and me) at Pop!Tech - one of the most eclectic and entertaining conferences in the world. Thanks to them for the invitation to present the project. RepRap was in a session with Matt and Jessica Flannery's Kiva, which is another extraordinarily good idea - visit their website too.

We made an impression, and got a RepRap version 1.0 "Darwin" set up and working in the conference coffee area, where it excited considerable interest (especially when the extrude head jammed for a few minutes with an expensive crunching noise...).

RepRap visits a FabLab

Thursday, 25th October 2007 by Adrian Bowyer



Here are Ed and Adrian discussing the machine with Joseph Okor from the FabLab in the South South End Technology Center in Boston. The Lab's Ed Baafi is behind the camera.

We hacked in an old PC power supply they had lying about to get it running.

Then it crashed :-)



However, this was a FabLab, so they soon equipped Adrian with a soldering iron, and he unplugged the extruder and re-soldered the lead to the thermistor which was causing the problem.

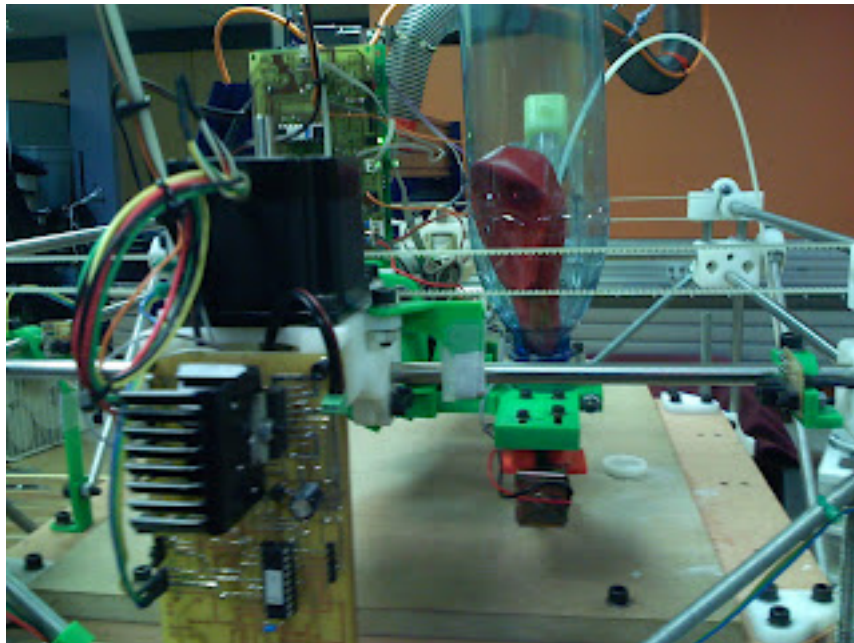

And we were able to make them the start of the shot glass before it was time to pack up and go home.

Thanks to Ed and Joseph, and also to Neil Gershenfeld whom we had met there earlier in the day, for their hospitality. We shall send them a RepRap extruder so they can experiment with integrating it in one of their systems.

Open-source is so cool...

Time to sort the software

Monday, 29th October 2007 by Vik Olliver

Why no pictures of printed bits recently? Well, we're sorting out the software. Part of this involves sorting out the development tools so we can sort out our software, which has resulted in yours truly abusing the Debian packaging system to produce 2.7.4 SDCC DEB files. If anyone can make a better go of it, please do. If you want to see what I did to it, the files are online here:

<http://reprap.org/bin/view/Main/SDCC>

I've also rebuilt GPUTILS: <http://reprap.org/bin/view/Main/Gputils>

Vik :v)

RepRap Part Lister

Friday, 2nd November 2007 by Zach Smith

One of the unique things to RepRap, and open source hardware in general is the fact that we're dealing with real, physical objects. Instead of having library dependencies in order to 'build' our 'software', we have parts needed to build our hardware.

A simple example: the opto endstop needs a PCB, a couple resistors, the optical switch, and some wires. In the software world, settling dependencies is fairly easy: download and install the right software. In the physical world, you need to get your hands on the real part.

That's where the part list generator comes in. We have all (or most) of the required parts for the RepRap project stored in a Google spreadsheet. This gives us an easy way to store, update, and show the parts required for any individual module. However, it becomes a pain to try and figure out how many nuts or bolts one needs to construct a Darwin.

The parts list generator takes this google doc, and transforms it into a MySQL database. It can then generate aggregate part lists for any combination of modules you'd like. We've even taken the time to enter part numbers from a variety of manufacturers. From there, we can do nice things for you like generate unique part lists by manufacturer. We've even taken it a step further to allow you to order all the parts you need from Amazon in one click, or to copy and paste a part list into Mouser to make it super easy to buy the electronic components needed to build the circuit boards.

As always, this software is all 100% open source. You can browse the source if you want. I'm pretty happy with how it turned out, but I'd love to incorporate more code contributions or have more parts from more part manufacturers.

RepRap at Linuxconf Australia 2008

Saturday, 3rd November 2007 by Vik Olliver



Image not found.

Lucky me gets to present on the RepRap at Linuxconf Melbourne 2008, with the fancy title of "The Replicators Are Coming!" I'll be bringing along a RepRap Inna Box and they'll probably rope me into the Open Day as well. Pia can be very persuasive...

Vik :v)

Extruder Casting Photos

Tuesday, 6th November 2007 by Zach Smith



I recently got a set of molds for the extruder from Adrian. After acquiring the proper casting goop, I decided to spend a day learning how to do it and see if its something I could do myself. Turns out, its really easy!

The basic process is this:

- * insert cores into proper places
- * spray with mold release (this definitely helps)
- * mix and pour in liquid plastic
- * wait til plastic hardens
- * remove cores
- * remove cast parts
- * trim/clean up cast parts
- * clean cores
- * repeat

casting a set of parts from beginning to end takes about 30 minutes, although 15 of those are waiting for it to cure. this is good for someone like me who multitasks alot. i'll setup the molds in the lab, cast them, and while they are curing, i'll work on something else.

i plan on trying to make my own mold as well, because then i'll be able to double my production while only slightly increasing the time it takes. its pretty much just as easy to setup and pour 2

molds as it is to do 1 mold. i have an old, non-straight extruder that i should be able to get a mold of, so eventually people will be able to choose between old and new if they want.

there are pretty much only 2 or 3 major hurdles keeping these out of the RRRF store:

1. brass bearings. i dont have a supplier for these yet, but i do have an idea for how to make them rather easily from brass 10-24 nuts. i'll be trying it out this week, and if it works, then we'll be in business!!

2. assembling and testing it. i still need to fully assemble a cast version and test it just to make sure that it works 100% as advertised. this is still a research project and sometimes things wont work, but i certainly don't want to sell stuff to researchers that hasn't been tested yet. hopefully the resin i'm using is strong enough. we'll find out soon enough =)

3. get the final part list. i need to double check the part list in order to create the kits to sell on the store. this will also be helpful for people who want to order them directly from McMaster, etc. specifying the right nuts, bolts, washers, etc. will really help out alot.

we're close to having extruders generally available!!

[More pix on Flickr.](#)

DC Motor Driver v1.0 Documented

Wednesday, 7th November 2007 by Zach Smith



Just wanted to give a heads up that the new DC Motor Driver board has been fully documented with full build pics, information on the board, and even some cool hacks you can do with it like drive a (small) stepper motor.

Please note, that this is a prototype board for the next generation of Arduino based RepRap electronics, and is not currently supported by our software. I'm working hard on getting the Arduino firmware up and running, but if anyone wants to help out just drop a line in the comments or email me.

RepRap User Groups

Saturday, 10th November 2007 by Sebastien Bailard

Looking for people who also want to build RepRaps? Want to band together on group buys for a supplier to save on costs? Have a machine shop but not good at soldering pcbs? Live outside the US and don't know where to buy stepper motors? Already having a RepRap and want to show it off? Get your RepRap some cognitive and emotional life from "Buy a machine that makes copies of itself" to "I'm a RepRaper" and others the way you would expect to see on a forum. Working on this too?"

we've created a dedicated set of subforums, which you can also get to by going to our forum site, <http://forums.reprap.org/index.php>, and drilling down to to RepRap User Groups.

If you don't see a subforum, direct to <http://forums.reprap.org/index.php> and click on "Log in to:

and tell us where you live, and we'll set one up.

Thoughts on printing at ambient temperatures

Sunday, 11th November 2007 by Forrest Higgs

I hit a technical problem back in September and you haven't heard much from me since then. I've been able to print in HDPE and am well on my way towards sorting out the problems with using brushed gearmotors to run both the extruder and the Cartesian positioning system of Tommelise. I'm publishing in the main blog rather than the builder's blog this time in that the issues that I am addressing impact on both Darwin and the various repstrap machines that are abuilding.

As you are all aware by now, I am sure, HDPE and to a lesser extent CAPA tend to curl when extruded at ambient temperatures.

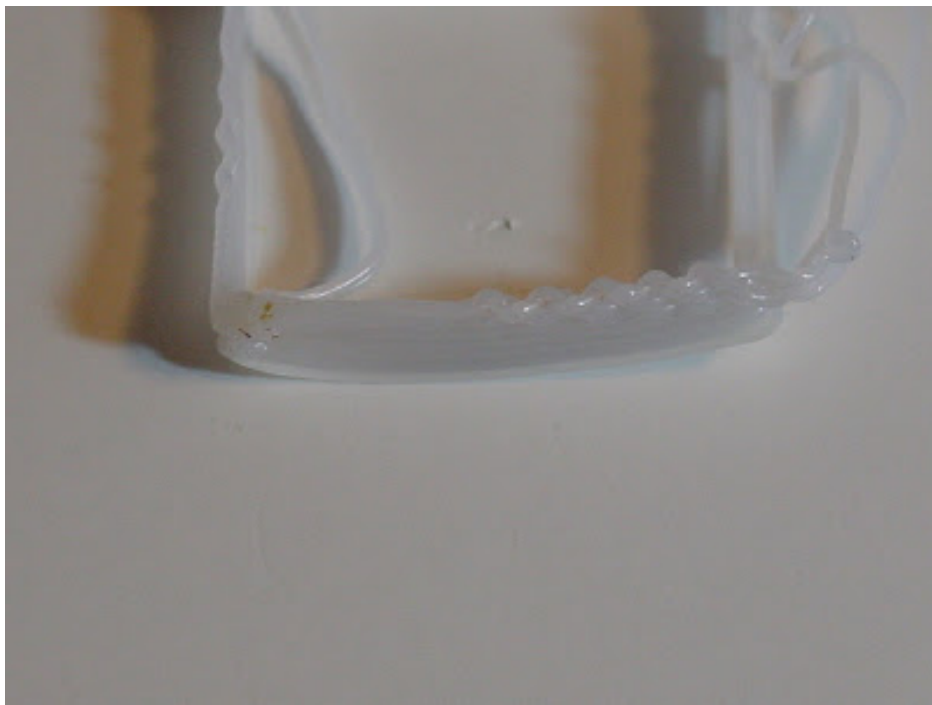

This curling tends to happen at corners when the aspect ratio of the object being printed approaches 1. When you have long objects you tend to get curling in the plane of the longest dimension. Nophead published some really compelling photos of this effect over in the builders' blog last month.

I got very discouraged about the warpage issue and resolved not to share my misery with the rest of you if and until I came up with a viable solution to the problem.

-
[\(Read the full story\)](#)

New Firmware Release

Wednesday, 14th November 2007 by Adrian Bowyer

Thanks to Andreas Unterluggauer we have a new firmware release. This improves the communications functions and reduces (indeed, on the Bath Darwin eliminates) comms errors.

You can get the .hex files from Sourceforge here:

https://sourceforge.net/project/showfiles.php?group_id=159590

or get the sources using subversion at:

-
<https://reprap.svn.sourceforge.net/svnroot/reprap/trunk/reprap/firmware>

Extruder output profile

Wednesday, 14th November 2007 by eD

Trying to nail the parameters on the Bath Darwin, I realised that the only factor I'm flying slightly blind on is the output of the extruder. Here's an output profile for Capa using a target temperature off 100 °C and a 0.4mm nozzle for a variety of motor speeds.

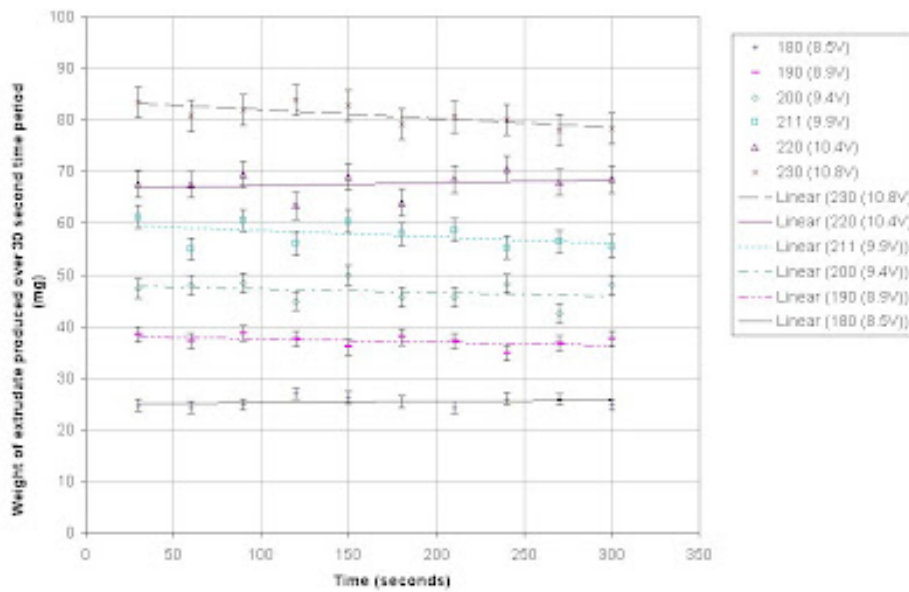

WARNING: 12V motor used in this test. (i.e. Don't put 12V through the standard issue 6V motor!)

Postscript: RepRap goes home from the USA

Thursday, 15th November 2007 by Adrian Bowyer



Right. How the *!?! am I going to get my shirts *and* this lot in my suitcase?

(Thanks again to Steve Carll for the photo.)

Amazin' Saddles

Friday, 16th November 2007 by Vik Olliver

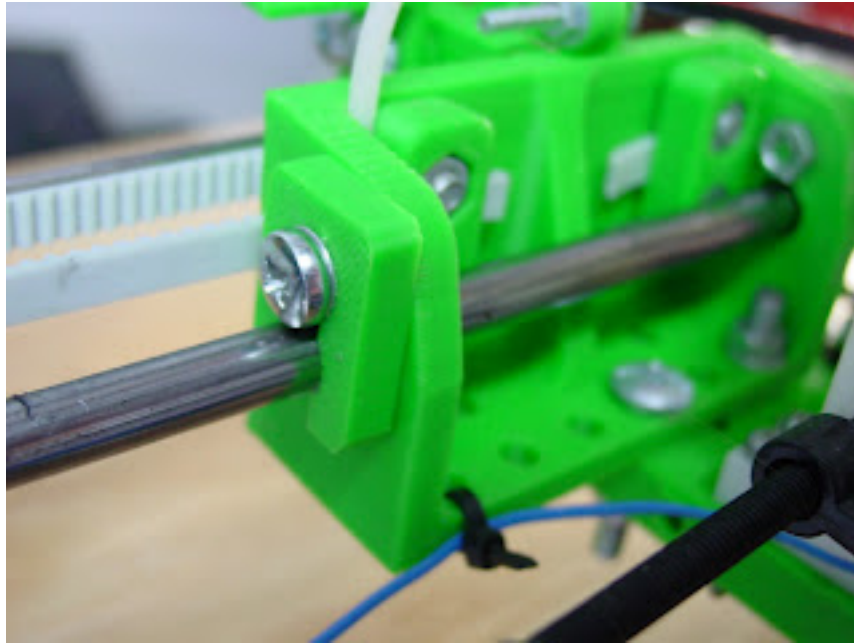

Ed was kind enough to run off some saddles that grip the X axis rails and stop the carriage rotating when there is a little slack in the carriage's bearing inserts. I'd made some from CAPA earlier, but they were a little ugly and not machine fabricated so they had to go...

Yes, I did try making them out of PLA on my Darwin, but this exposed the software bug that Adrian is beavering away on, with some success. I'll just wait for confirmation from another source that they're worth putting on the RepRap and then I'll wiki them. Meanwhiles, if any cowpoke finds their carriage a little rattly on the rails, go git yerself some amazin' saddles.

(The blue wire in the photo goes to my diagnostic thermocouple, and the big black screw in the lower right corner belongs to the clamp giving extra pressure to the PLA extruder.)

Vik :v)

PowerComms v1.3 Released

Wednesday, 21st November 2007 by Zach Smith



Our new Power and Communications board has now been fully tested and documented. It features many improvements, most notably diagnostic LED's for Tx and Rx (yay blinken lights!) It also has a better layout, more reasonable capacitors, and more power outputs.

Check out the [documentation](#) (now with lots of pictures).

We also have it fully stocked in the [RRRF store](#).

Thank you to everyone who helped out to make this happen. This is an excellent incremental improvement over our previous board and takes us one step closer to having an awesome robot that prints us out cool things. Keep up the good work guys!

Thank You MAKEzine!

Friday, 23rd November 2007 by Zach Smith

I was honored and very excited today when I loaded up one of my favorite blogs and saw a podcast about the RepRap project. This is the first podcast in a series of podcasts, and I'm very excited to see how the rest of them turn out. Makezine has been a source of inspiration for me, and I'm sure it's been inspiring to others on the project as well. It feels fantastic to see the stuff I've worked so hard on to be featured there.

If you are wandering in here in search of instructions on how to build each board, then look no further. Here are direct links to the wiki pages of each of the boards used in the podcast:

- Stepper Motor Driver
- DC Motor Driver
- PWM Driver
- Power/Comms Board
- Opto Endstop

Keep in mind that these are the experimental (and hopefully next-generation) versions of the RepRap electronics and you're treading into territory that is *not quite* fully documented nor supported by software. We're working on this as hard as possible, and its likely that the rest of the software will be written in the next week or so.

New z flag adjuster

Tuesday, 27th November 2007 by eD

Those of us in the tweaking stage will appreciate the level of control needed over the position of the first layer. Here's a gizmo I made to get better control on the z flag using an M5 bolt. I've uploaded the part files onto the latest SVN release of the bot.



Producer/LayerProducer code changes

Tuesday, 27th November 2007 by eD

Hi, just committed some important changes to the code:

-**Important:** First layer now prints @ z=0 i.e. home position (previously @ z=extrude height).

It's quicker and easier to tweak the nozzle to home position to the right height for the first layer, which was previously a bit of a hit and hope. Plus it's safer, at the home position the nozzle doesn't have to physically touch the bed, which it just about has to if first layer printing starts at z=extrude height.

- Bruce's bug fix to stop extruding on dry segments! Hurrah!
- Included commented code for horizontal and vertical hatch vectors.
- Streamlined warm-up sequence.

Resin paste-extruder valve

Thursday, 29th November 2007 by Adrian Bowyer

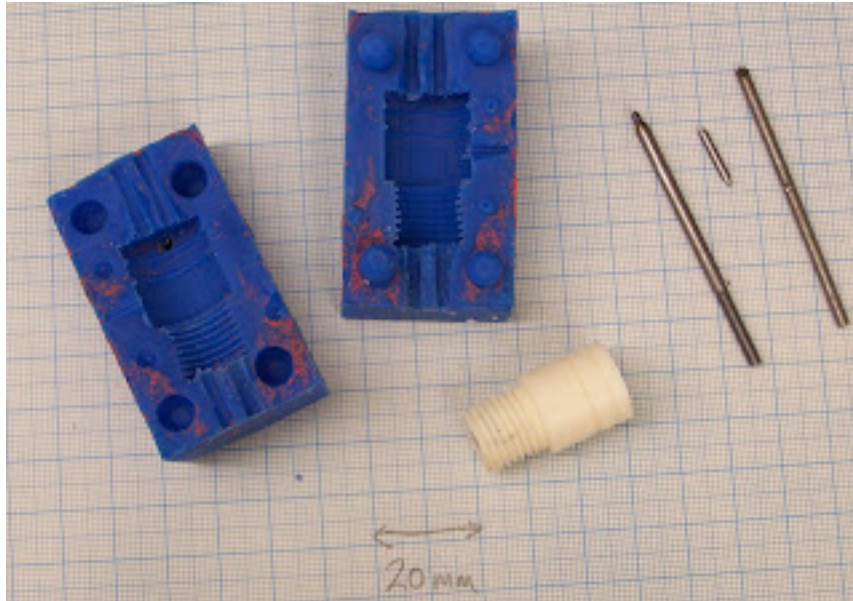

The valve mechanism in the experimental paste extruder was a bit difficult to make as it needed some machining. I've now done an alternative that uses rapid prototyping to make a blank and then soft casting in a silicone mould to produce the final item. You can't quite use rapid prototyping for the whole thing because RP is not good at threads, and this has an M14 one.

The advantage of this approach is that once you have set it up you can make a lot of these devices quickly and easily by repeated casting.

It uses the trick of trapping nuts in the resin to give good retention of screwed-in parts - see the soft casting page again for details.

Machinist Help Needed

Wednesday, 5th December 2007 by Zach Smith

The RRRF is looking for someone to make certain metal parts for the Extruder Kit. If you are that someone, you know that someone, or you're interested in submitting quotes to companies, please read the post and get back to me.

Ideally this will be someone in the USA because shipping costs make it impractical for the small number of items I need.

Thanks!

RepRappers: Unite!

Friday, 7th December 2007 by Zach Smith

Our esteemed colleague, Bruce Wattendorf has created an open google map for RepRappers to use to add their locations to. A few of us have already put our info up on the map, and if you're interested in proudly displaying your location you should too!

A day in the life of RepRap

Friday, 7th December 2007 by eD

Thought you guys might be interested... here's working day on RepRap @ the Bath University end:

Tuesday

A Wet Weekend in Taupo

Sunday, 9th December 2007 by Vik Olliver



Not a bad weekend, actually. Participated into a project to build an impressive electric racing car (the Saker EV) in NZ, which meant attending a conference in Taupo for a couple of days. So, not much rewrapping done, but I have at oh-dark-hundred managed to get the thing going like it was before I messed with it. I just changed too much at once without proving my new extruder barrel first.

So I'm now rewrapping a V1.0 diagonal tie bracket, which is not very well shaped for single material printing. I've run one off anyway, just to test the machine while fixing up the corner bracket, and it's nearly finished. As it prints internal overhangs, it is creating this amazing "spaghetti-filled cavern" effect...

Hope to print a V1.1 and restart the changes more slowly by sticking in just the new X axis PIC.

Vik :v)

Half a step forward

Monday, 10th December 2007 by Adrian Bowyer

I've corrected the PIC firmware so that it now correctly does half-stepping. It's checked back into the Sourceforge repository in Subversion.

This means that we can definitely use the cheaper 200-steps-per-rev stepper motors. You need a bipolar one where the coils can take a voltage of 12v and each use a current of 2A or less.

Details on the forums [here](#).

Wiping up

Tuesday, 11th December 2007 by eD

The nozzle oozes a bit for a few seconds after the extruder motor's been shut off. Naturally the dribble spoils the build a bit, so I thought I'd try building in a wiper to clean its nozzle before each layer. The framework comes off the diagonal, and looks a bit like an intergalactic spaceweapon. Things under test so far are razor blades and car windscreen wipers.

I'll keep you posted.

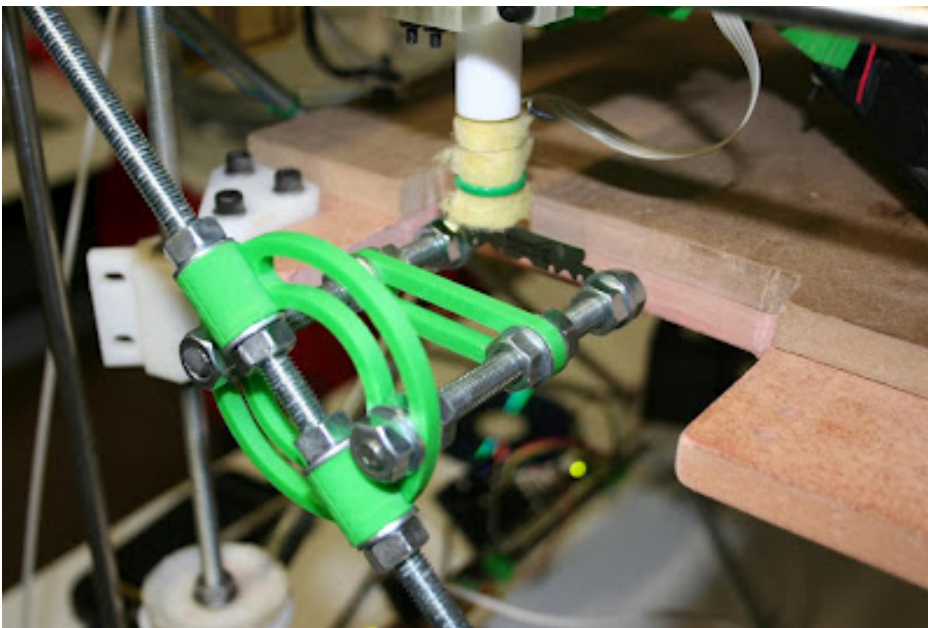

Commit to SVN for nozzle-wipe method

Thursday, 13th December 2007 by eD

I've committed a nozzle wipe method to the latest version of the software. This enables the nozzle to do a cleaning routine at the start/end of each layer. At the moment the cycle is as simple as can be (back and forth), but the structure's now in place for this to be developed. Here's some more parameters for your local properties file:

```
Extruder0_NozzleWipeEnabled=false
```

```
Extruder0_NozzleWipeFreq=4
```

```
Extruder0_NozzleWipeDatumY=12
```

```
Extruder0_NozzleWipeDatumX=20
```

```
Extruder0_NozzleWipeStroke=15
```

```
Extruder1_NozzleWipeEnabled=false
```

```
Extruder1_NozzleWipeDatumY=12
```

```
Extruder1_NozzleWipeDatumX=20
```

```
Extruder1_NozzleWipeStroke=15
```

```
Extruder1_NozzleWipeFreq=4
```

Print Head Auto-Encapsulation

Saturday, 15th December 2007 by Vik Olliver

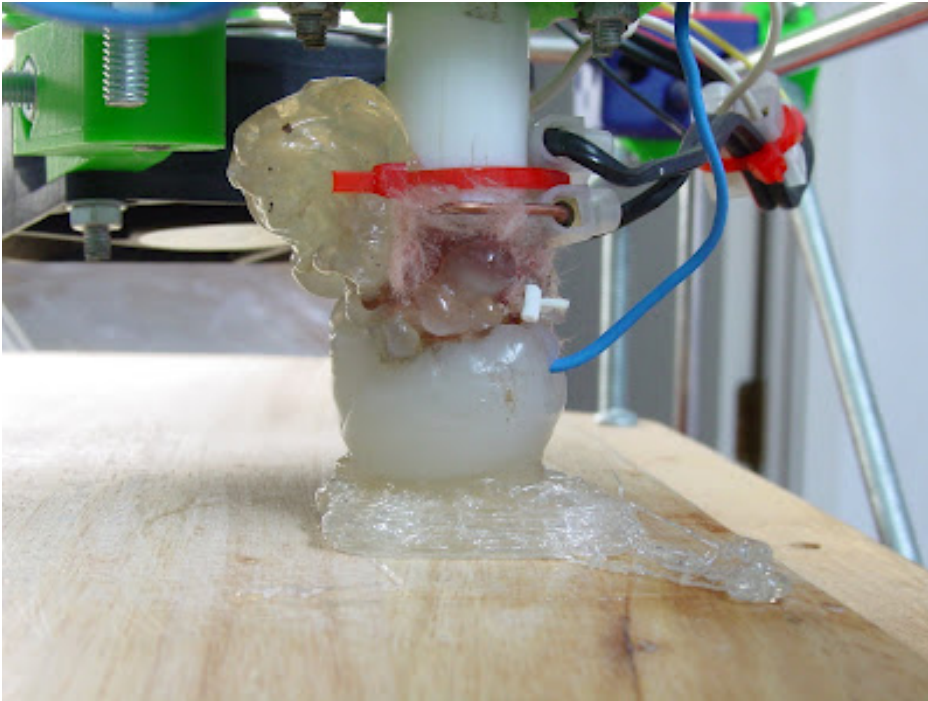

Millions of years ago, this prehistoric RepRap print head stumbled into a freshly emerging stream of molten PLA. It became trapped, the PLA smothered it, and it became completely encapsulated. Now this specimen is perfectly preserved, and industrial archaeologists can observe its primitive construction in minute detail. It may even be possible to extract early RepRap developer DNA.

This is going to be a complete bugger to chip free. I'll probably bake it at 150C for a while and pull all the crud off. The cable tie and terminal block will melt, of course. At least there is a thermocouple conveniently embedded in the blob. The girls, however, want me to preserve it as a memento so I may have to build a new one.

How the heck? I left the thing running overnight doing an X Axis Constraint and a serial error caused it to stall with the extruder motor and heater running.

Vik :v)

eMachined Extruder Parts

Tuesday, 18th December 2007 by Zach Smith

Recently, a cool dude by the name of Scott McClure emailed me about locating a supplier for machined parts. He mentioned a site called emachineshop.com which is really awesome. They have a free CAD application you can use to design parts to be made, get quotes, and order parts, all within the same application. I had heard of them before, but I didn't have a ton of experience with CAD so I didn't follow up.

Anyway, Scott suggested that we use them to get the machined parts we need for the extruder. Not only that, but he went above and beyond and made drawings up of the parts we need! He emailed me those files to look at, and hopefully have parts made from eventually.

The prices are reasonable at the quantities we're looking at, and the work that Scott did was very good. Here's the situation: it does not make sense to do a test order of a small number of parts, so we pretty much have to do a production size order. Obviously this runs the risk of getting 100 parts that are not what we need or want! I trust that the drawings Scott did are correct, but in the interest of perfection I present the files to you, the community to help spot any potential mistakes. Many eyes make bugs shallow, right?

Here are the files in question:

extruder drive screw - this is one piece with an extra 10mm of drilled shaft that is intended to be cut off by the end user to make the nut assembly to solder to the motor end of the braided wire.

half bearing - these are the bearings for the extruder drive screw.

heater barrel - this is the aluminum heater barrel for the extruder. (w/ 3/8"-16 threading)

ptfe barrel - this is the insulating PTFE thermal barrel. (w/ 3/8"-16 threading)

So please, download the emachineshop software, open the files above, check them out, and post any problems you find in the comments. This is really important, because a mistake could cost the RRRF hundreds of dollars (which at this point in the game, is a large amount)

Cheers,
Zach Smith

Experimental firmware working

Wednesday, 19th December 2007 by Adrian Bowyer

I have now imported Andreas's improvements and corrections to the PIC firmware into Simon's experimental autoconf version of the code for the PIC16F648A. It all compiles, and - when put in a RepRap machine - works (at least it did for me...).

If you want to download it it's at

<https://reprap.svn.sourceforge.net/svnroot/reprap/branches/autoconf-firmware>

You should probably also look at Simon's instructions on the forum at:

<http://forums.reprap.org/read.php?2,3861,3862>

We need to do a bit more testing. Then if this all pans out OK this'll become the Subversion trunk version and we'll do a release.

The compiled .hex files (remember they're for a PIC16F648 or PIC16F648A, not a PIC16F628) can be downloaded from [here](#). Unless you have more than one extruder on your RepRap, you can ignore the file extruder_1_.hex.

By putting this:

```
#define TESTLEN 53
static byte testArray[TESTLEN];

void init2()
{
testArray[TESTLEN-1] = 1;
...

```

in stepmotor2.c and increasing TESTLEN until the linker barfs I deduce that we have a whole 53 extra bytes to play with in the stepper code now!

Encapsulated Extruder Hopeless - Built New One

Friday, 21st December 2007 by Vik Olliver

The previous extruder got trapped in a ball of PLA. The family wishes me to keep it as a memento and it looks fairly dicey to excavate so I've built a new one. Still no JB Weld about, so it's held together with BBQ paint again. I have learned through my mistakes though:

1. The thermistor is now mounted on a copper tag for easy removal.
2. The dome nut nozzle has been reshaped to a thinner point.
3. No insulation - it just absorbs plastic.
4. Heavy copper wires crimped to the nichrome heating coil.
5. Actually did wrap both ends of barrel in PTFE before assembly this time.
6. When drilling barrel using drill press, drill in half way from each end to keep hole central.

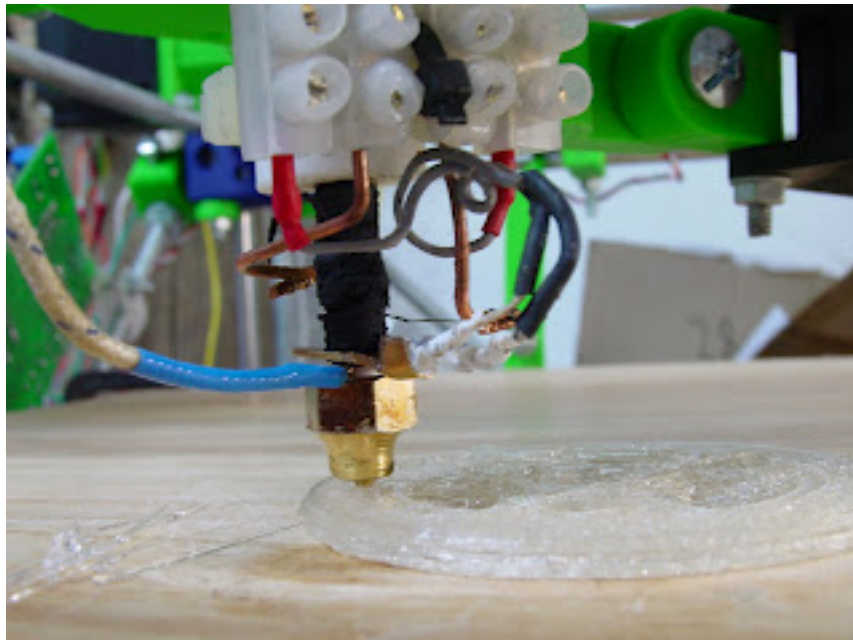

The first one I built had a pinhole leak in the barrel where my lousy drilling clipped the thread. I discover this after assembly. Moral: Check for leaks.

During testing I blew up 3 PICs. Moral: Insulate your thermistor leads well.

I also discovered that thermistors with a very low (<500 ohms) resistance at operating temperature spook the PIC's temperature measurement causing the heater to operate intermittently. If you've got one of these, stick a 560 ohm resistor in series with it and all should be well. You'll have to recalibrate of course. Moral: Try to use stock parts.

And now, she works again.

Vik :v)

[No Title]

Monday, 31st December 2007 by Vik Olliver

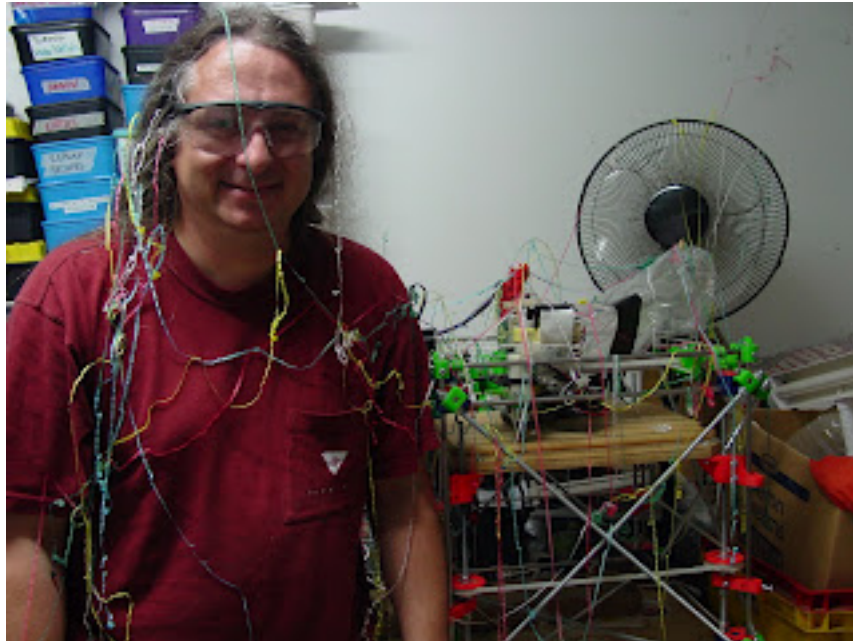

Happy New Year to all RepRappers from "The land of the long, white cloud" aka Aotearoa, aka New Zealand!

My Darwin (festooned in streamers by the girls) is in a compact state today, as I've been building a packing crate for it and checking the size a lot.

Vik :v)

New manufacturing process

Thursday, 3rd January 2008 by Adrian Bowyer

This is not directly a RepRap idea, but I wanted to post it

1. Because it could be useful, and
2. To stop anyone patenting it if it is.

As you know, we've been playing with silicone soft moulds for making things in resin:

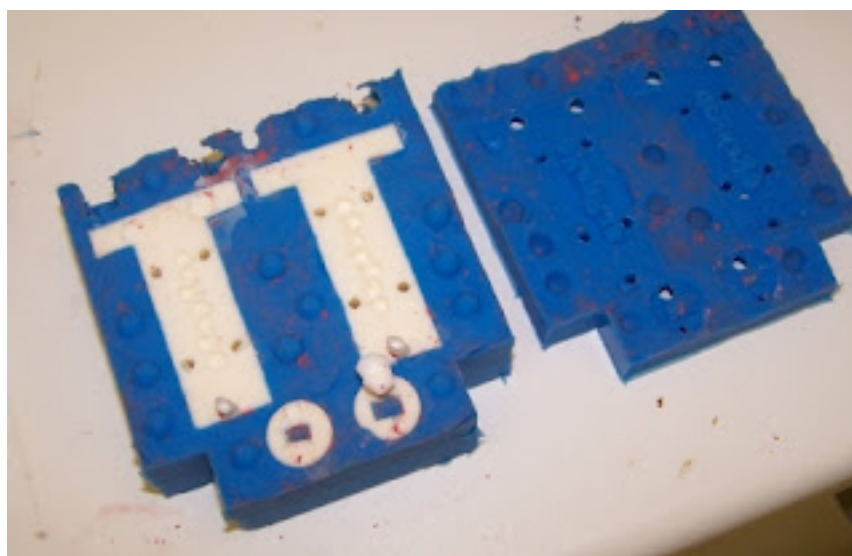

Suppose, instead of pouring in resin, you put a loop of wire in the cavity, flowed an electrolyte through the mould, switched on a current, and metal-plated the wire? Might it plate to fill the cavity with a metal object to match the cavity's shape, with the rate of deposition slowing as the growing surface approached the silicone where there would thus be slower flow?

Just a thought...

RepRap at UK Science Museum

Friday, 4th January 2008 by Zach Smith



Congratulations to Toby Borland who has recently had his wooden lasercut RepRap machine featured at the UK Science Museum. From what I gather, Toby works for SMARTlab and is doing some really cool things.

You can read an article about the exhibit (how I found out about it... thanks google alerts!)

PWM Driver v1.1 / DC Motor Driver v1.1 Released

Sunday, 6th January 2008 by Zach Smith



I've finished two new versions of the boards for the Arduino electronics. These are incremental improvements that offer cool stuff like more blinky LEDs, minor fixes, and such. Full build pix, tester code, and everything you need to know to get started with these boards.

The DC Motor Driver board will control 2 small DC motors (or you could drive a small stepper if you wanted).

The PWM Driver board will control 3 channels of PWM at up to 5A each (theoretically) This is used for things like fans, heaters, etc that just need to be turned on/off.

The files are released on SourceForge, the boards are for sale in the RRRF store, and everything should be fully documented. If there are any questions, please let me know in the comments!

Paste Extruder water tests.

Sunday, 6th January 2008 by Vik Olliver

Here's a quick video of Kate and I testing our copy of Adrian's Paste Extruder prototype. We've loaded it up with 50ml water and excessive pumping.

Adrian has also made some beta firmware that we hope to get out there soon, using the PIC16F648A CPU. I've stuck it in my Darwin and seem to be able to make things extrude.

Darwin now has a snug carry-case, and I hope to test it out on a trip to Wellington in the near future.

Vik :v)

Reprap Host 0.8.3 Released

Monday, 7th January 2008 by Jonathan Marsden

It has taken while, but here it is...

I've "packaged" (as .zip files) the Reprap host code tonight and tested it on:

- (1) Ubuntu 7.04 (NullCartesian as PC has no serial port and I lack a USB->Serial widget),
- (2) Ubuntu 7.10, and
- (3) Windows XP

The last two were both tested with real Reprap electronics, as far as the Stepper Exerciser being able to talk to each of my X Y and Z axis boards appropriately.

The file most people will want is reprap-host-0.8.3.zip, available at

<http://downloads.sourceforge.net/reprap/reprap-host-0.8.3.zip>

If I'm not too distracted by other things, I'd like to get a first public set of .deb packages, and a first public Windows NSIS-based .exe installer released by the end of the month (January 2008). This is a goal, not a promise :-)

NOTES:

(1) The big change as far as packaging goes in 0.8.3 is that it allows for the RXTX and Java3D and j3d.org libraries to be in a static place that is unaffected by JAVA_HOME, and so remains independent of which Java version you are running. This has been tested on both Linux and Windows, and is a large part of what has allowed progress on "real" installation packages to occur. If you already have the libraries installed under \$JAVA_HOME/lib/ext, that's OK, we'll still find and use them from there.

(2) The reprap.properties file has changed a fair bit since 0.8.1, so if you want to easily see all the new properties, consider renaming your old reprap.properties file and then running the Reprap software -- it will generate you a new one with all the new things in it. But then you'll have to edit all your customizations back into the new one!

First Corner Bracket

Tuesday, 8th January 2008 by Vik Olliver

OK, so I have a Corner Bracket in PLA. Took about 10 hours to print. I'm trying a second one now, just to make sure it's not a fluke. I'll update with photos later.

As it comes out of the RepRap, the stringing within the part obscures many of the holes, and drilling is required to make the part usable. Is this considered minor refinishing? A cordless drill with 8mm or 5mm bit basically guides itself into the right position; I just hold the PLA bracket in my hands and try not to drill my fingers.

Blobs are apparent at the end of each layer, when the nozzle halts and the RepRap software figures out the next one. The nozzle oozes.

The Corner Bracket has rounded corners which will not print without overhanging, and these cause knock-on wall collapses up the side of the corner bracket. It would be better if the corners were square.

Mid-way up, the distance between hole and corner is quite small. This results in a rather fragile-looking corner. This would be strengthened by leaving the edges square, but an extra mm of wall thickness wouldn't hurt either.

Is it strong enough? Just, I think. For the moment I'll call it good enough to try and build another Darwin with. After a week I should have a full set of Corner Brackets!

Vik :v)

Segment pause bug-fix committed

Thursday, 10th January 2008 by eD

Some new properties for you for the latest SVN:

Extruder0_ShortLength=1.5

Extruder0_ShortSpeed=1

Extruder1_ShortLength=1.5

Extruder1_ShortSpeed=1

Adrian's new code speeds up the nozzle for short segments. This work-around massively improves previous problems caused by segment-pausing (the pause between segments was causing a noticeable extrudate dump between short segments, over a radius for example. The new fast speed option evens things up a lot).

Temperature constraints for the extruder in `GenericExtruder.setTemperature()` have also been tightened from 10% & 20% to 3% & 6%.

Happy printing ;-)

Advanced Electronics Thoughts

Friday, 11th January 2008 by Zach Smith

I've been thinking a lot lately about the Arduino and some of the cool advanced things we could do with it. Some of it was spawned by threads in the forum about servos vs steppers and some of it was because of some problems we've been having with thermistor style temperature measurement (blown thermistors, inaccuracies at high temps, etc.) Anyway, I've been working on a couple new circuits that have the potential to be very useful.

Thermocouple Sensor

This one is a high quality temperature measurement board based on the AD595 chip. It uses a thermocouple to measure temperature, and is specifically designed to be used with Type K thermocouples. The nice thing about a thermocouple is that they can withstand *very* high temperatures. The type K thermocouple is rated for up to 1200C. That's hot. The sensor board is really just a PCB to house the AD595, an LED, screw terminal, and the interface pins. The vast majority of the work is done by the AD595 which takes the signal from the thermocouple and converts it into an output that is ideally suited for an ADC converter. The way it works is that the AD595 outputs 10mV/C... which means that it is *very* simple to convert a reading from a thermocouple to a Celsius reading.

The circuit is mostly done, but I'd love to get some feedback before I have a prototype run made. Given the small size of the board, a prototype run will still be 100+ boards. Anyone want one to play with?

All the Eagle files are located here:

<http://svn.reprap.org/trunk/users/hoeken/arduino/electronics/thermocouple-sensor/>

Magnetic Rotary Encoder

A rotary encoder is a circuit that allows you to precisely know the rotational position of something. In our case, we'd use it to know the exact position of our motor. This one is a high precision rotary encoder based on the Austria Microsystems AS5040. It uses a magnet on the drive shaft, and a chip that detects magnetic fields (the AS5040) to detect and tell us exactly what position it is in. The AS5040 offers 10-bit resolution (1024 positions/revolution) and offers a TON of outputs: quadrature encoding, PWM output, analog output, and a shift register style output. This board takes the AS5040 and brings all the outputs out to us so that we can use the one that matches our needs.

This circuit is less done. There are still some things to be done in the schematic (help/feedback wanted):

- * add a power-on indicator (good idea?)
- * add a calibration LED based on using a single pullup with the maginc/magdec pins (not sure how to do this)
- * needs to be laid out properly and in such a way that its as small as possible
- * figure out the best way to put mounting holes on to make it as easy to use as possible... (right now i'm putting 4 holes... one on each corner.)

All the Eagle files are located here:

<http://svn.reprap.org/trunk/users/hoeken/arduino/electronics/magnetic-rotary-encoder/>

Keep in mind these boards would be intended to make it easier to for people to build and experiment with more advanced technologies that will hopefully someday become part of a core reprop system. Its still very early in the game for these boards, so any feedback now will be greatly appreciated (and used!)

Corner Bracket photos and Bed Corner

Friday, 11th January 2008 by Vik Olliver



Here is the shot of the two finished corner brackets. The furthest one has been trimmed of string, the nearest has not. They seem functional but I need more to know for sure.

Note how the holes in the sides have been sealed off by stringing. This problem has since been much reduced.

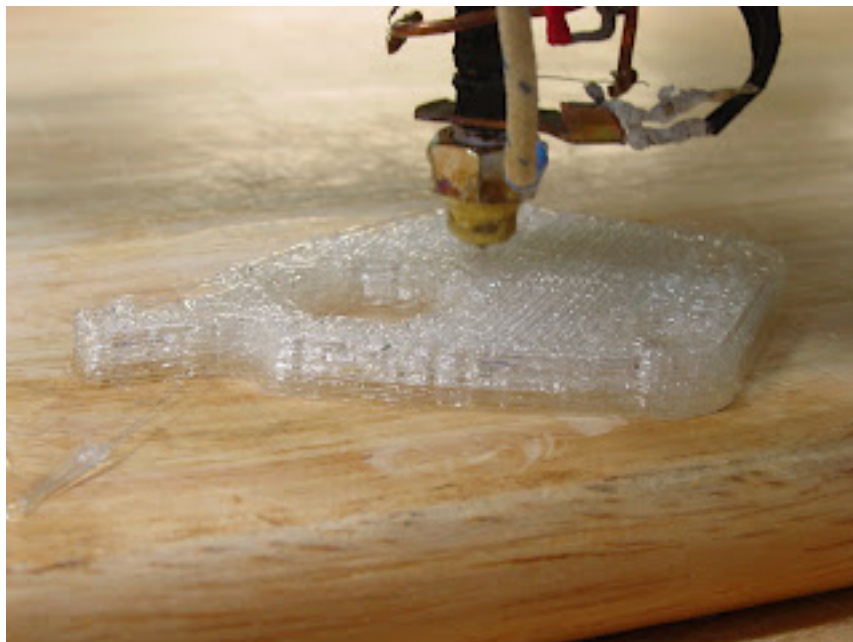

Here we have the start of a Corner Bracket (that died 1 min after I took the photo due to me tugging the USB lead out). Steve DeGroof kindly modified the STL file so that it will print without

support material and so I decided to give it a whirl. The RepRap is running much faster following Adrian's recent changes to speed corners up, as I have been able to raise the speed in general.

Two other milestones: The communications now copes if you disconnect the serial lead and reconnect it again - though not so happy if you disconnect the USB lead! Also I've now printed with over 100m of PLA filament.

Vik :v)

Bed Corner Printout Success

Saturday, 12th January 2008 by Vik Olliver

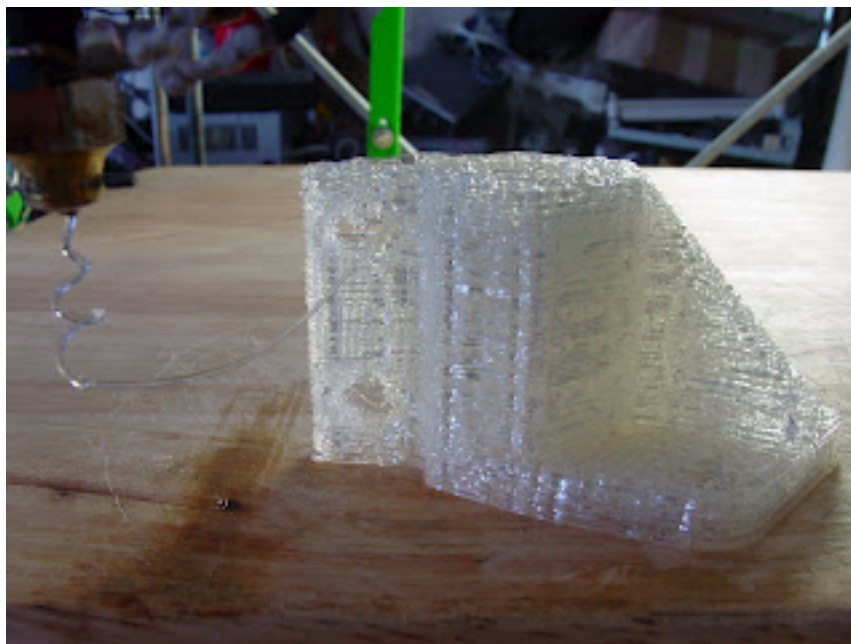

It took me 3 goes. One cable pulled, and a stuck filament roll; but I got it printed in the end. Thanks to Steve for helping with the STL file. The object took 5.8 hours to print in PLA using Darwin hardware and Adrian's latest fixes. It has really picked up steam now and the quality has improved as the nozzle moves faster - as predicted.

No hint of curling on this part either.

If you look inside the holes on the left, you can see some stringing, but it is now more like annoying cobwebs than a barrier that needs drilling out with a cordless drill. Just as well - I did stick an 8mm drill bit in my hand last time.

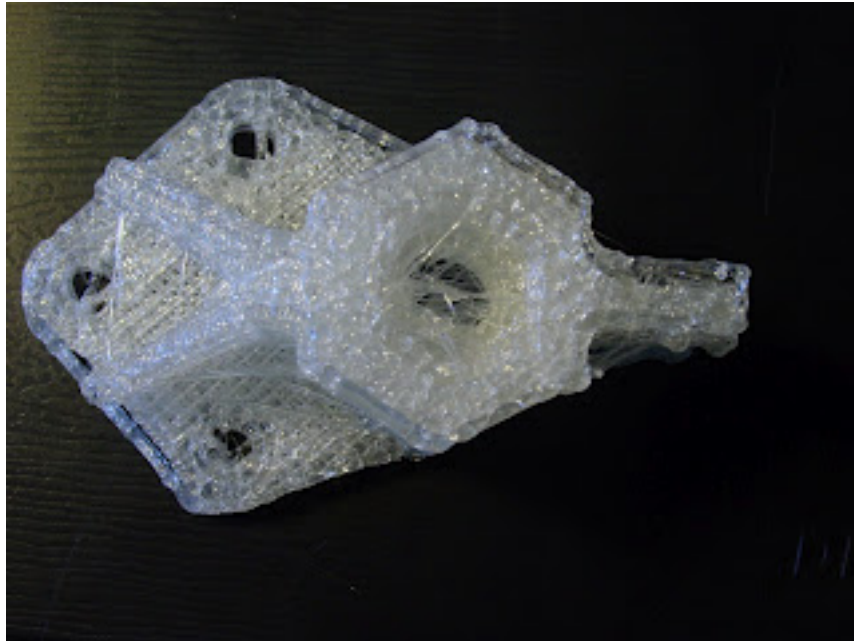

Here's the view from above, with a clearer view of the stringing. The thick stuff is caused by a plotting error we're looking into, and the fine, spider-web stuff is what the more persistent stringing issue now looks like.

I've tried to bend the part, and it doesn't break despite the plastic flow being a little low, so we should be good to give it a go in a real Darwin.

Vik :v)

Arduino Firmware v1.1 Released

Saturday, 12th January 2008 by Zach Smith

Yay! I finally got non-sick, non-busy, and non-not-in-New-York and got a few hours to sit down mano-a-arduino and finished the RepRap protocol integration. The hardest part and biggest challenge was implementing the Celsius -> PIC temperature reading (as well as PIC temperature reading -> Celsius). Thanks to Steve DeGroof, I was able to plug some values in for an 'ideal' thermistor and everything worked like a charm. The PIC emulation is accurate within a couple degrees at the high end (250C) and within a few tenths on the low end (room temp).

What this all means is that the Arduino based electronics are now 100% compatible with the current host software.

For all those who are using the Arduino based electronics, its **highly** recommended that you upgrade (otherwise, they wont really work.) Here's what you gotta do.

1. download the new firmware from SourceForge.
2. copy the library files from the firmware .zip into your arduino's library directory. overwrite the old libraries if you have an older version of the RepRap Arduino firmware.
3. update the firmware and host software prefs as per the wiki.

Thats it! If you have any questions, bugs, or suggestions, let them fly in the comments.

Bed Corner and Diagonal Tie Bracket

Sunday, 13th January 2008 by Vik Olliver

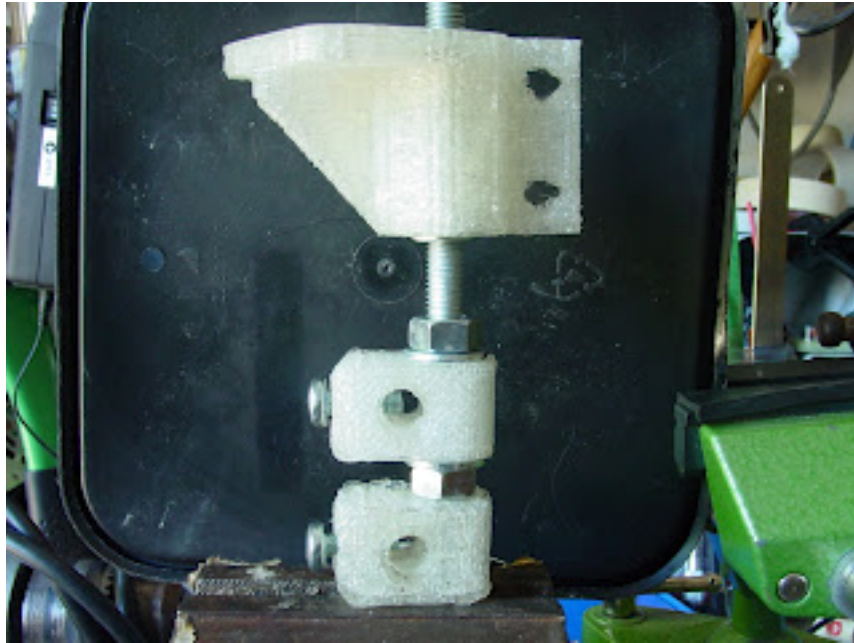

Here's the Bed Corner mounted up with springs & nuts on a piece of studding. On the bottom of the studding I've stuck 2 Diagonal Tie Brackets. The top one - from Steve's no-overhang STL - is printed using the new software and has not been manually tidied (though I did have to warm up the retaining nut to get it in), the bottom one was done with last month's software and has been tidied. Adrian's latest fixes have made quite an improvement in quality, I'm sure you'll all agree.

Sadly, printing Corner Brackets in fine detail seems to cause a new bug so no more of them for a little while. But I'm off to Wellington in a few days anyway, and I'll be taking Darwin with me.

Please ignore mess at "dirty" end of bench...

Vik :v)

Darwin on CAPA

Wednesday, 16th January 2008 by eD

While Vik's been blazing trails with PLA I've been trying to get our Darwin to follow suit with CAPA. Finally, the variables are coming together, and last night we printed it's first part: the y-belt clamp. I'm proud to say that this is what it looks like straight off the bed, no post-processing needed, and the M5 bolts screw straight in! (1 small square = 1mm)



My best lessons so far have been getting the temp relatively high, $\sim 130^{\circ}\text{C}$ (to reduce extrudate viscosity and prevent extruder stalling), and to spend time getting the layer increments spot on (to guarantee layer bonding). I'll upload my variables today into the 'tweaking' section of the wiki.

Extrusion at different temps

Friday, 18th January 2008 by eD

For a speed of 188 (8.81 V) on the Solarbotics 12V version of the GM3 motor, I tried extruding CAPA at different temps. Temps are recorded using the extruder's thermocouple:

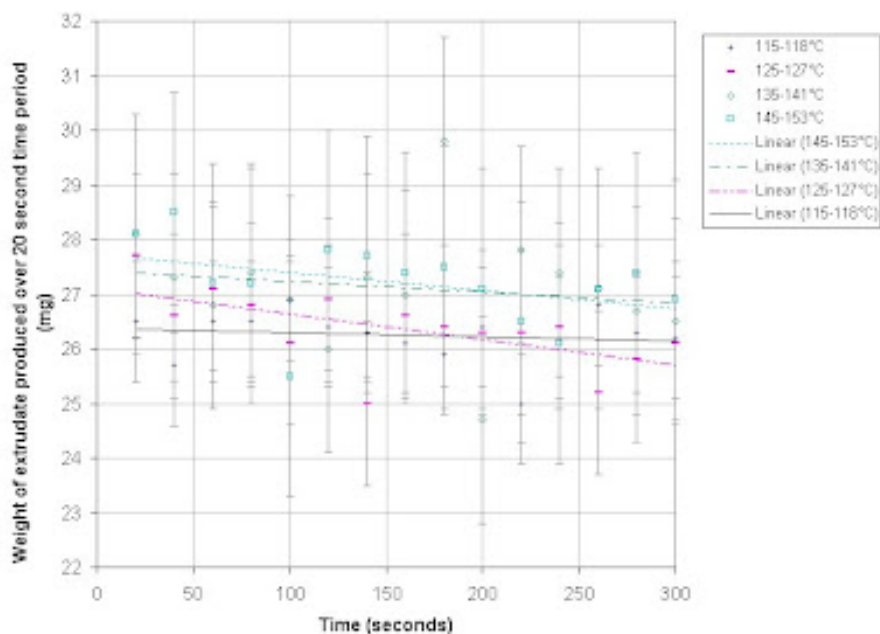

It's good to see quite a tight distribution of trends here, as high filament temp eases the load on the extruder, however, it's worth bearing in mind Vik's previous comment: "Be wary of running over 100C. If your plastic has absorbed moisture, you may get steam bubbles. If they're small, no problem. If large, they interrupt the feed of fine extrusions."

Geared extrusion

Friday, 18th January 2008 by eD

Adrian and I designed this gearbox today. We made it on the Strat too, coz RP's good like that. It includes brass bushes for the gear bearings and bought in MOD gears. Previously, using the 12V Solarbotics GM3 motor, I'd been getting stalls at low speeds. This new arrangement safely cuts output rpm down to a third, which, I'm hoping, will give the other parameters a bit of breathing space. We shall see...

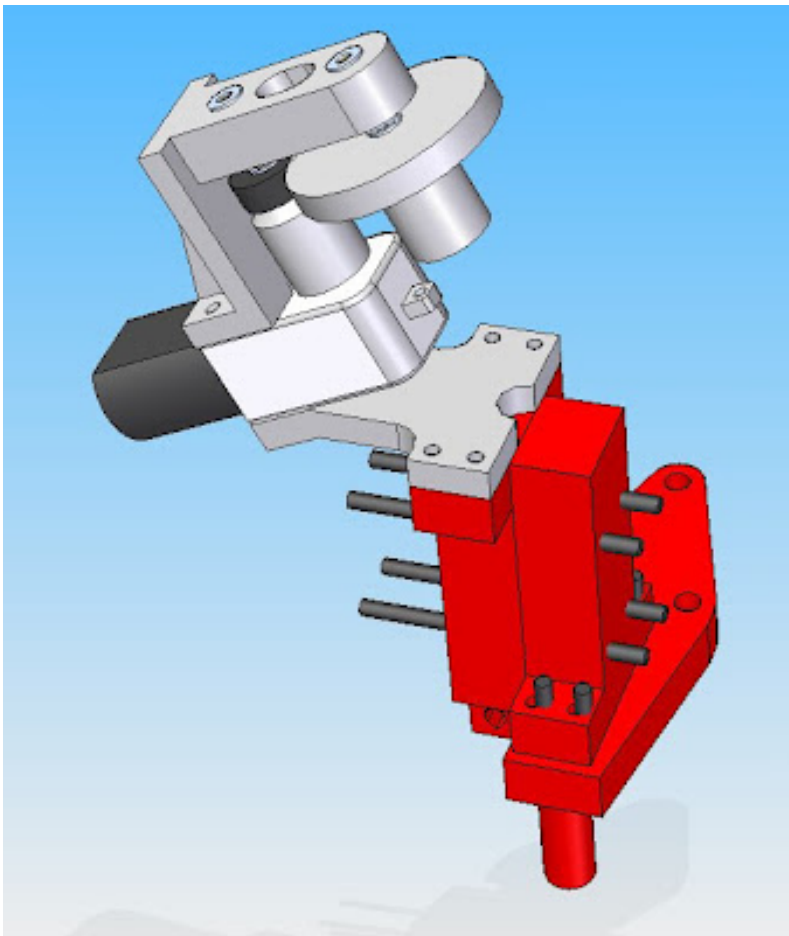

Optoswitch bracket printed

Sunday, 20th January 2008 by eD

There's not enough time-lapse in the world, so here's some more. Plus some Aerosmith because there's not enough of that either ;-)



Z Axis Kebab Printed

Sunday, 20th January 2008 by Vik Olliver

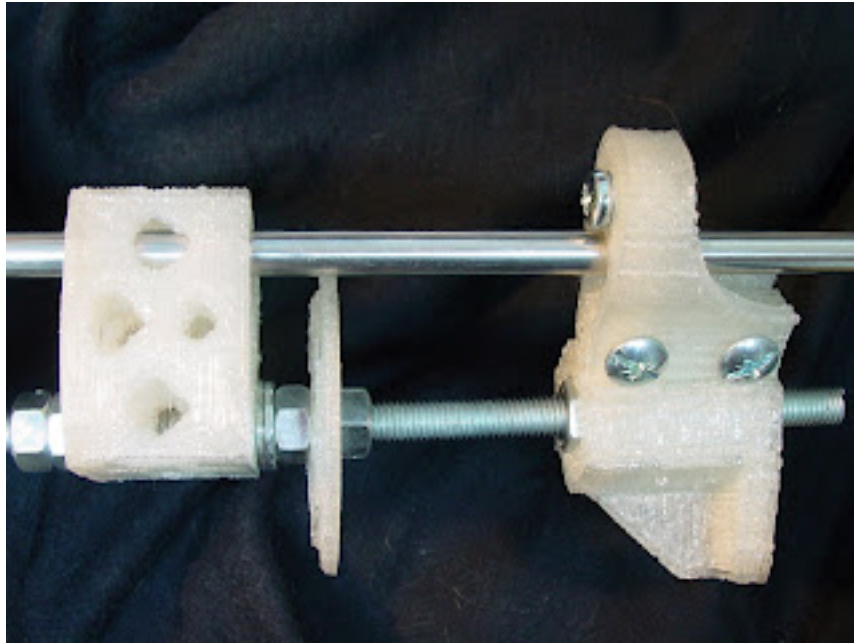

Just finished a Corner Bracket, Bed Constraint Bracket and its insert. I've stuck them all on the same rod, and the centre of the insert does line up with the corner bracket's hole. Bolts are now sliding in without having to attack things with a power drill.

Missing from the collection is the Z studding tie, which gives our software a little trouble - Adrian is working on it. Meanwhile I'm extruding Darwin parts with my PLA extruder on Darwin at just over 4cc/hr.

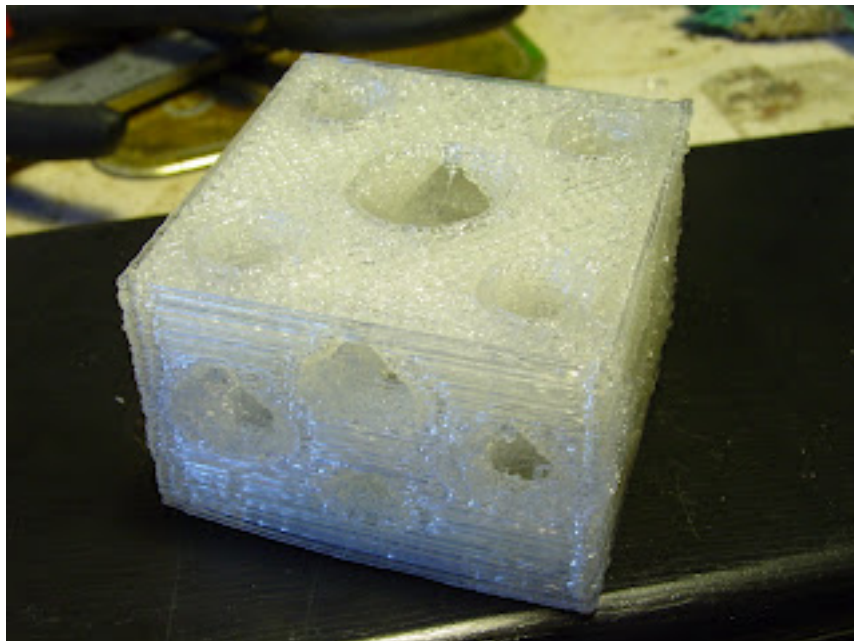

And just for Ed, another close-up shot of that corner bracket.

Vik :v)

Extruder feedback

Monday, 21st January 2008 by eD

The RepRap electronics already have the facility for extruder feedback but we haven't got round to implementing it yet. Today Adrian and I got onto it. We decided to go for a fringe for the drive cog. While this wont pick up backlash it does have a much higher capacity for resolution.

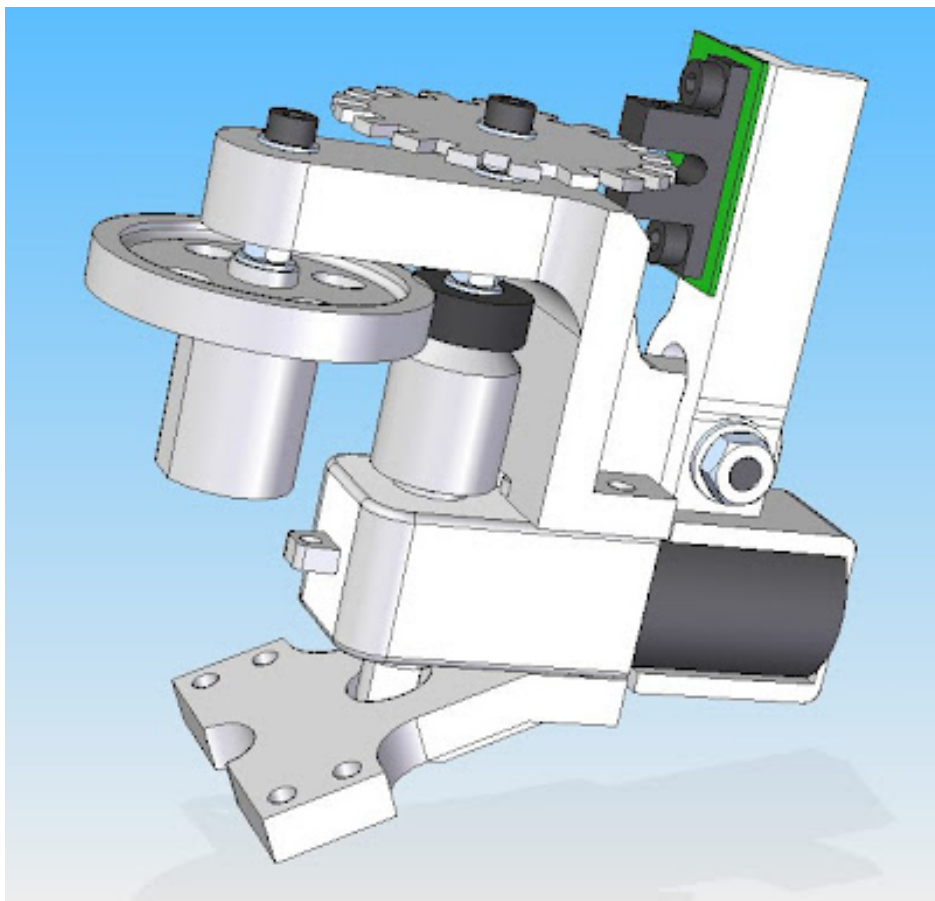

In stereo - another opto bracket

Monday, 21st January 2008 by Vik Olliver

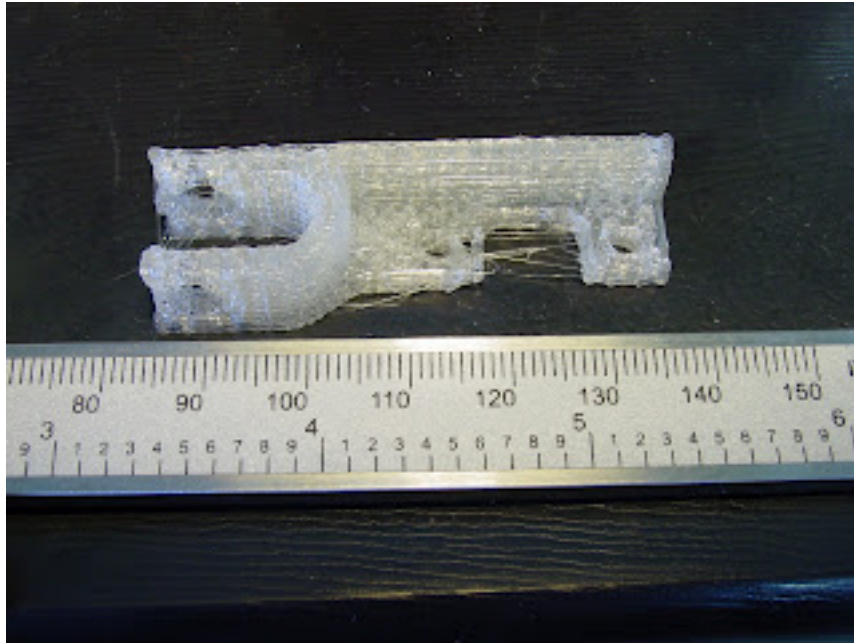

Following in Ed's footsteps, I've run off a copy of the opto bracket in PLA. The build time was 51 minutes, extruding at just under 140C. Looks good from here.

Vik :v)

On the road to replication

Tuesday, 22nd January 2008 by Vik Olliver

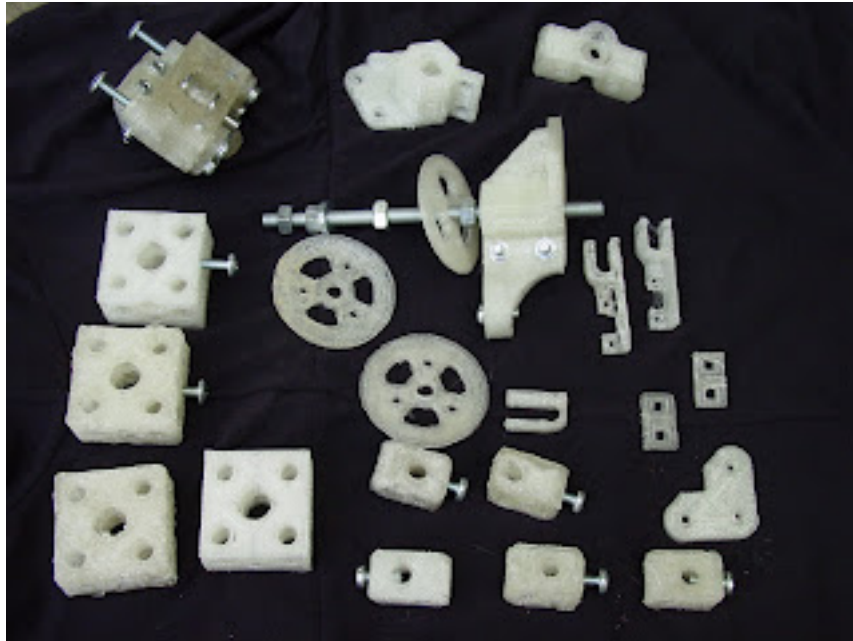

Ed tells me that my Darwin is now extruding at half the speed of the Stratasys FDM machine - albeit at a lower quality. Once I've replicated my combined output will be approximately the same as said machine with significantly less outlay. So, if you're wondering how many RepRap bits I've actually made from PLA, and hence how far off replication we are, have a look at the picture.

There's a variety of different versions of software in use, with the old ones looking distinctly lumpy, but the parts are functional.

Vik :v)

Update from he who feels like hammered sh...

Wednesday, 23rd January 2008 by Vik Olliver

I've taken the cutting board off the RepRap and given it a damn good sanding flat, checking it with a steel ruler like my old Design & Technology teacher showed me while I was busy wrecking his workshop. Adhesion improved, particularly for large areas. Not managed to print an X Motor Bracket properly yet.

The Y Bearing Housing I printed the other day broke when I put the insert in. I found that there is an area inside that gets no infill, and so the part is really fragile. I narrowed it down to a pretty damn minimalist debuggable shape and sent it to Adrian, the internationally famous geometry guru. A mere 8 points or 12 triangles.

Brain currently fried due to insomnia, my back is aching like hell through painkillers, and LinuxConf is less than a week away. Ohboy.

Vik :v)

Another pile of parts falls out of the RepRap

Thursday, 24th January 2008 by Vik Olliver

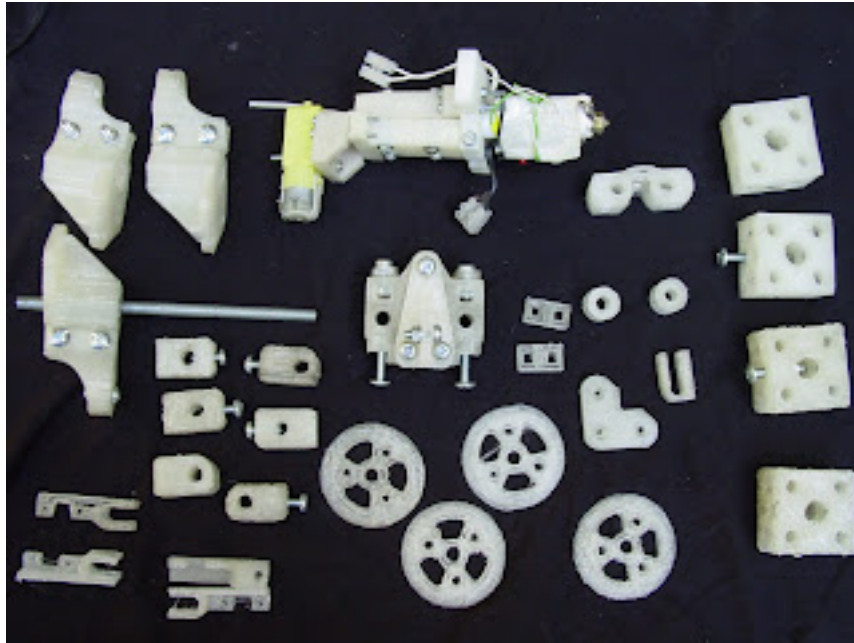

Due to popular demand (Hi Adrian!) here is another snapshot of the parts fabricated so far, including the extruder made on Zaphod. You may note a few other additions - opto brackets, bed corners and XY idlers - have joined in. I've been eating up the filament from Imagin Plastics in Henderson like it was spaghetti, and may well have to go back there cap in hand. I do have enough to finish fabricating this RepRap and to feed it well enough to make the next generation. CAPA supplies are coming soon, so I might have a go with CAPA extrusion again later. See you in just over a week!

Vik :v)

PTFE slippage

Thursday, 7th February 2008 by Adrian Bowyer

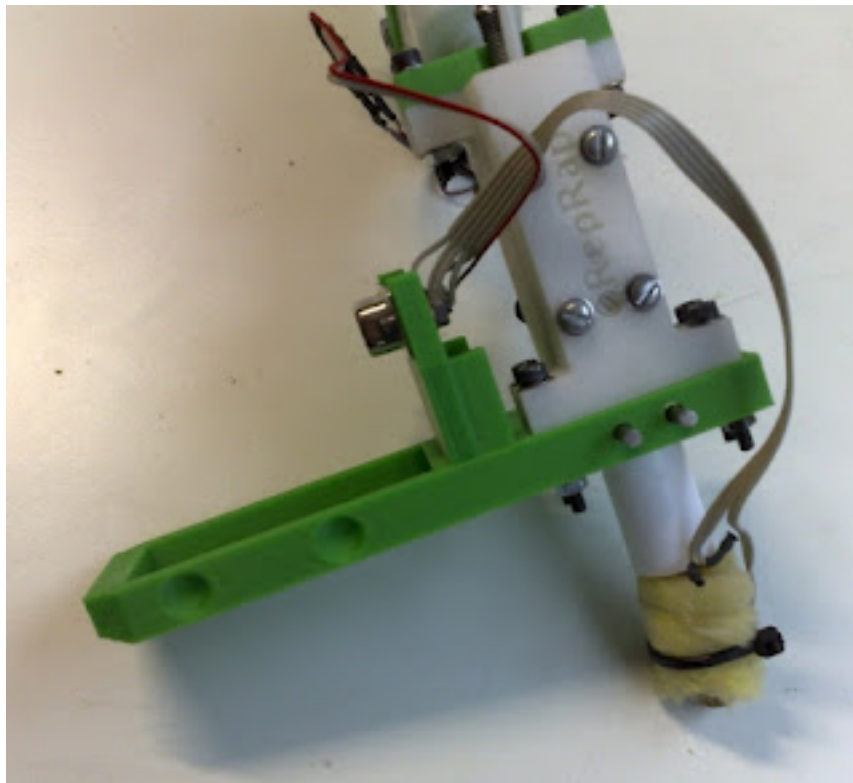

Some people have been having troubles with the PTFE tube slipping out of the extruder. I have done a design modification to fix this: I put a couple of 3mm holes sideways through the clamp.

You put the PTFE in and clamp it gently, then run a 3mm drill down those holes. A couple of 3mm pins (or screws) placed in the holes then prevent the PTFE moving downwards under the force from the screw drive.

I've run this with the clamp screw just finger tight, and it all works solidly.

You can do this as a retro-fit: drill the holes (take care to miss the central hole where the polymer filament runs...) and put in a couple of pins.

I've checked in the modified clamp design to the repository.

Back from Melbourne

Friday, 8th February 2008 by Vik Olliver

Being allowed to present RepRap at [LinuxConf 2008](#) was wonderful, and thanks to all for the encouragement I got that really belongs with the RepRap team. So many new ideas, and very little time spent on repairs all considering.

One that stood out was the idea of using RepRap to print braille, and to make relief maps with textured surfaces to assist the blind.

I contacted the OLPC project to see if they would cooperate on ensuring an OLPC can drive the RepRap. Currently our software won't fit, and the OLPC is essentially python-driven so a re-write or novel way of printing the CAD files might well be necessary as things stand.

Finally, I've been porting Toby Borland's plywood RepRap files to Ponoko's upload format and I think I've got something that should print. Whether one can actually assemble what comes out remains to be seen. The parts cost for RP'd parts, gears & base is in the region of USD\$350 and you can download the source. I say again, it's not quite perfected yet.

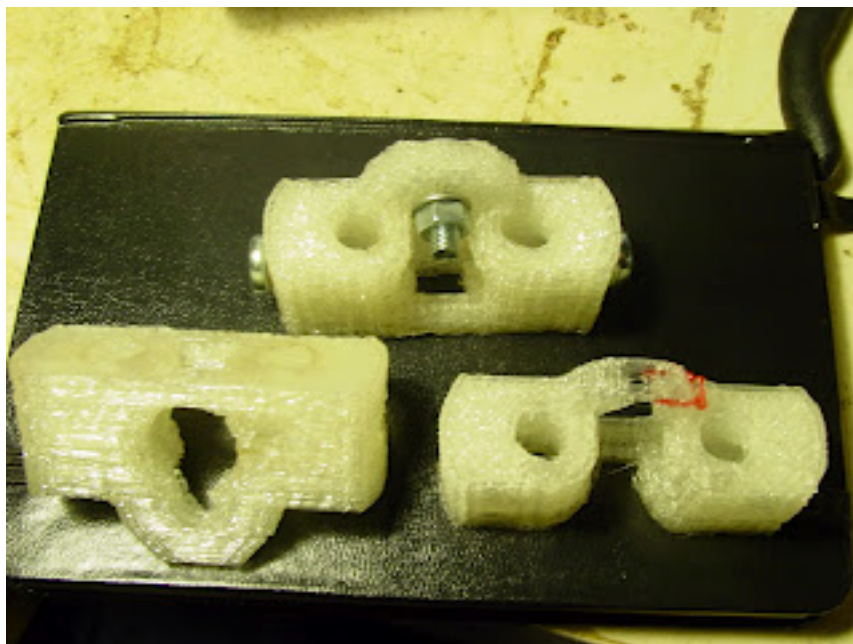

My Darwin has been chugging along while I work, having a little difficulty with the Z axis after its return from Oz. Perhaps I was just lucky before, but now the Z axis rubs on parts of the base. Being me, I've bashed holes to allow clearance for the nuts.

Here are three Y bearing housings, recently printed. One is marked with a break and is dud, the other two were printed after Adrian's recent accidental `sqrt()` bugfix. I now have 3 of them, and have manufactured bearings. Bearings look a little short on infill - OK, very short - but seem

functional. I've just done another corner bracket (3 to go) and the next part is: Replacement Y axis flag.

Vik :v)

X Motor Bracket

Saturday, 9th February 2008 by Vik Olliver

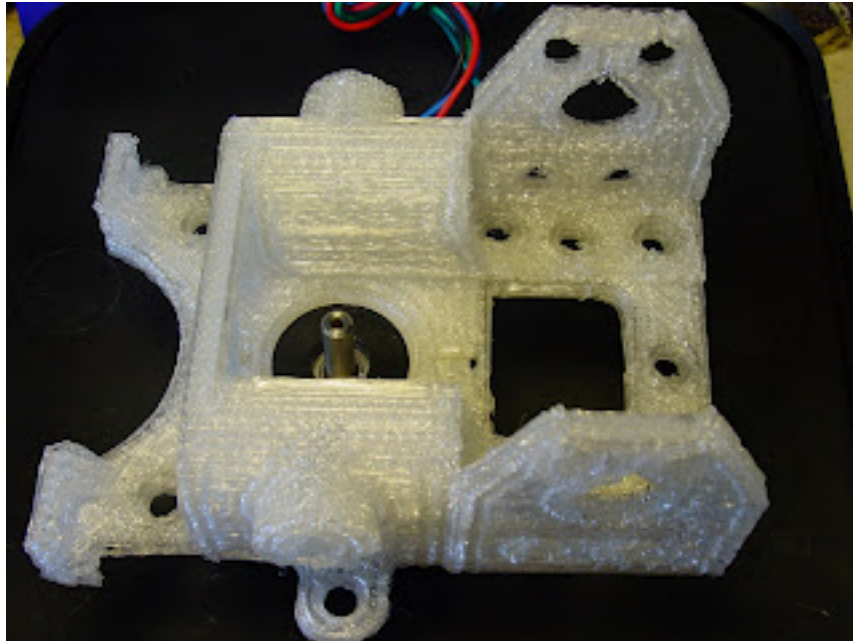

Need I say more?

Well, yes. The pads definitely stopped the corners curling. One pad didn't print (dodgy patch on baseboard most likely) and that corner started lifting. Not having superglue to hand after Oz, I put a dab of hot-melt glue on that corner to anchor it down, and that stopped the curl nicely.

The mounting slots for the smaller motors are a little short, but I've fixed the STL file and uploaded it. I'll just hold this one on place with some cunning wire-bending.

Next, the carriage.

Vik :v)

Half-Way to Replication!

Saturday, 9th February 2008 by Vik Olliver



A mini-milestone for you RepRap-watchers. Ed and myself have now fabricated half the V1.0 RepRap's parts, if you count them by type (i.e. we have 8 corner brackets but that only counts as one "part" even if I've only made one).

On the left is the latest batch of parts: X and Y axis Opto Flags, a couple of X Belt Clamps and a Z Studding Tie. I think the flags are the most delicate objects I've made, and appear to be approaching the limits for our current software's resolution.

Vik :v)

98% Of A Carriage

Monday, 11th February 2008 by Vik Olliver

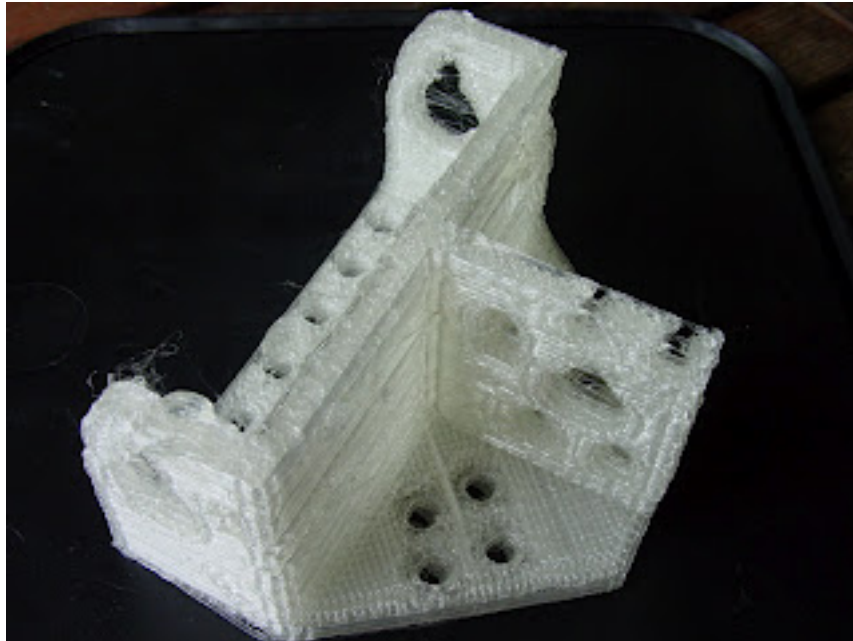

My LCD screen is starting to return to a less blue shade after enduring a stream of classic Anglo-Saxon last night. The cause of this was the crashing of the GUI software with an Out of Memory error about 98% of the way through the biggest part of the RepRap - the carriage.

I knew things were not going well. Garbage collects were happening with increasing frequency. I'd run the job to a nullcartesian device first to make sure it would print - probably best to close and restart given the current state of play.

I had "top" running, so I know it was all Java. No other applications of any consequence going on a 2GB machine.

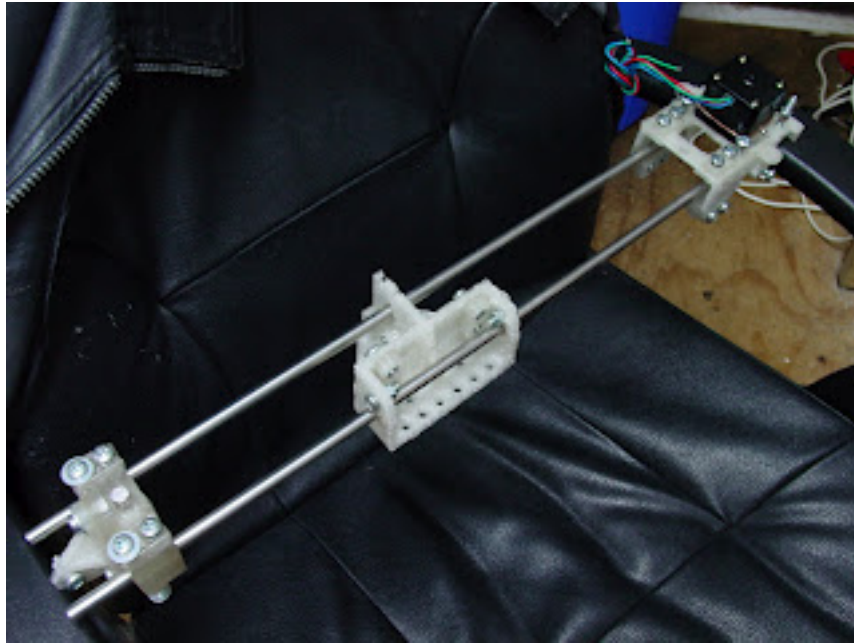

Now the good news: Though technically incomplete, on inspection the part appears quite functional. There are some big blobs on it where the extruder was left running in garbage collects (should we force a GC at the end of a layer? Can we, or will Java "know better"?), but these will soon succumb to my trusty Dremmel tool. I believe I can now start work on the X axis assembly, the first phase of mechanical construction in our instructions. Yeah, looks like the picture on the left :) I leant on the X motor bracket and cracked it, but clear epoxy cures all ills.

Vik :v)

Software Outside The Box (Updated)

Friday, 15th February 2008 by Vik Olliver

One of the frustrating things about developing the RepRap is the need to focus on making it actually replicate. I've had a few great ideas about RepRap pass me by for this reason, so I thought I'd better document them.

1. Make it print braille. In theory, easy. In practice, it needs someone to convert braille into STL (mistakenly called SVG earlier by torpid author).
2. A spooling device driver for the RepRap GUI. If we can produce pre-processed files, a much simpler production program is needed. This would allow RepRap to be driven by primitive controllers, PDAs and the OLPC.
3. A Logo turtle driver for RepRap. Logo is well understood in the educational sector, and runs on the OLPC. It would enable novel fabrication techniques to be developed by the young and inquisitive.

Pick it up and run with it, folks.

Vik :v)

Objects.RepRap.Org - Any volunteers?

Sunday, 17th February 2008 by Sebastien Bailard

As some of you know, the mediawiki we'd used as a template for objects.reprap.org has been infested with spammers for some time now. I've frozen the site in a spam-free but untinkerable state and will be mucking about with a cms-based replacement. I'm bringing this up because of an email from Tom Owad:

The Google 3D Warehouse has reached 300,000 objects, while the RepRap object library remains at seven. That size, coupled with the ease with which SketchUp and the 3D Warehouse integrate, has the potential to shut out open source software and place the world's object library in Google's hands. While I don't have a specific problem with Google, but I don't think a for-profit corporation makes the best library curator. There's great potential for things to go downhill at Google, especially after the founders die.

The Fab@Home project and all sorts of cnc projects all have their own independent libraries, none of which amount to anything substantial. I think it would be beneficial to see an organization dedicated to being a public library for objects, separate from any specific hardware project. I think it may be outside the RepRap project's scope to build an object library that can compete with the likes of Google, but it would seem to me that this is well within the abilities and the charter of the Internet Archive. Perhaps it might be possible to collaborate with the Internet Archive to create an open object library?

Thanks,
Tom Owad

If people want to take on this project and build a site to do this, please read further on for the project requirements. And please hop into the forum with your ideas and expertise:

<http://forums.reprap.org/read.php?58,9504>

My take on it is that it would be useful to use a CMS, like [plone](#).

I'll be tinkering on something to do this, but I don't know if it will work. Volunteering to help?

Introduce yourself:

<http://forums.reprap.org/read.php?58,9504>

or email me at penguin@supermeta.com

I know what I want it to look like, which brings me to...

Project Requirements:

A standard wiki isn't suitable for this project, because of their 'everything goes' permissions model.

This is fine for an anonymous article, but if you're putting up an artwork, or your group is working on a project, you don't want people stumbling along and tweaking or deleting it. (I'm not ruling out 'everything goes' projects, but most people will want more control over their projects, the way the linux kernel team won't let random users check in changes into the main code base without looking the changes over. This is also true if you have a flickr account.)

What we want in an objects library:

1) We want the obvious definition of an objects library. A straightforward hierarchical archive of files.

2) We want much more than an objects library; we want a site that can host RepRap and similar projects. Like [instructables](#) or the [reprap docs wiki](#). Otherwise, it's just another file archive, which Google 3D Warehouse can do better than we can.

3) Along with the communal area, we want people to be able to own their own personal and group subsite. Myspace or your own favorite online community is a good model for this, in as much as it reveals how people like to use the web.

Example usage patterns:

A: General random files. "Hey, I caught a frog and scanned it. Here's the scan. Oh and here's a windshield washer reservoir cap for my Range Rover, and here's a wrench." We need a way to store these files, and a way for people to find them.

Priority: High.

B: We want to be able to host the RepRap 3D Printer files on it. Along with the .stl, .aoi, and .etc files, we want our documentation to be up there as well. where they'd have documentation, files, and so on. Just like we're doing with RepRap.org currently.

Priority: Middling High. We need this in order to offer more to users than just a place to dump files.

C: The user 'Jane' might have a page like:

"[objects.reprap.org/people/tinker_jane](#)"

where she puts up her projects and files, and people can comment on them, and say hi to her if she wishes. Jane needs to be able to do this: "This lamp was my senior design project. You need to print these out, drill here, and solder this like so. What do you guys think?"

Priority: Not as High, but if we don't do it, someone else will, and everyone will end up using their site instead of ours.

Difficulties With Coupling

Tuesday, 19th February 2008 by Vik Olliver

Yes, I know, you have some e-mail about a pill that can fix that. I wish. The Y Motor Coupling disintegrated on my Darwin. Aha! I have a PLA spare! That lasted about 20 minutes (not even long enough to print a new spare) before it melted and deformed around the hole for the motor-side grub screw. Clearly, the polycaprolactone part isn't going to get a much better lifetime, 'cos it would just melt sooner. We can try going high-tech with adhesives, using stiff plastic tube and hose clamps, or just machining a part out of steel. I'm going for the hose clamps.

Vik :v)

Coupling Breakage Update & Images

Thursday, 21st February 2008 by Vik Olliver

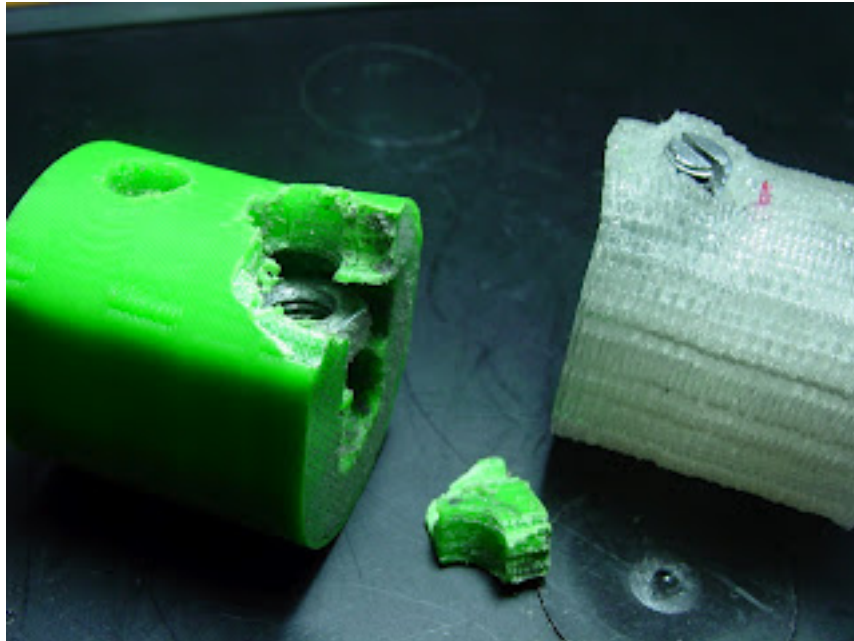

As you can see, the Y-motor coupling broke near the grub screw closest to the Y motor. It had printed pretty much an entire RepRap before it failed, I should point out.

So the replacement PLA part fared little better. It deformed but didn't crack up over 20 mins or so of constant operation - trying to print another Y motor coupling, of course. The red mark is merely a leftover from me marking the length of the grub screw.



An attempt to patch it with a couple of hose clamps and some thick PVC pipe 6mm ID (normally

used for hydroponics systems) also failed. After a while, the PVC softened and the coupling went all soggy.

I'll try a piece of Teflon. Hmm, nope, too weak - tap tears out. Teflon & hose clamps holding the grub in place, promising...

Vik :v)

My Darwin's First Print

Thursday, 21st February 2008 by Zach Smith

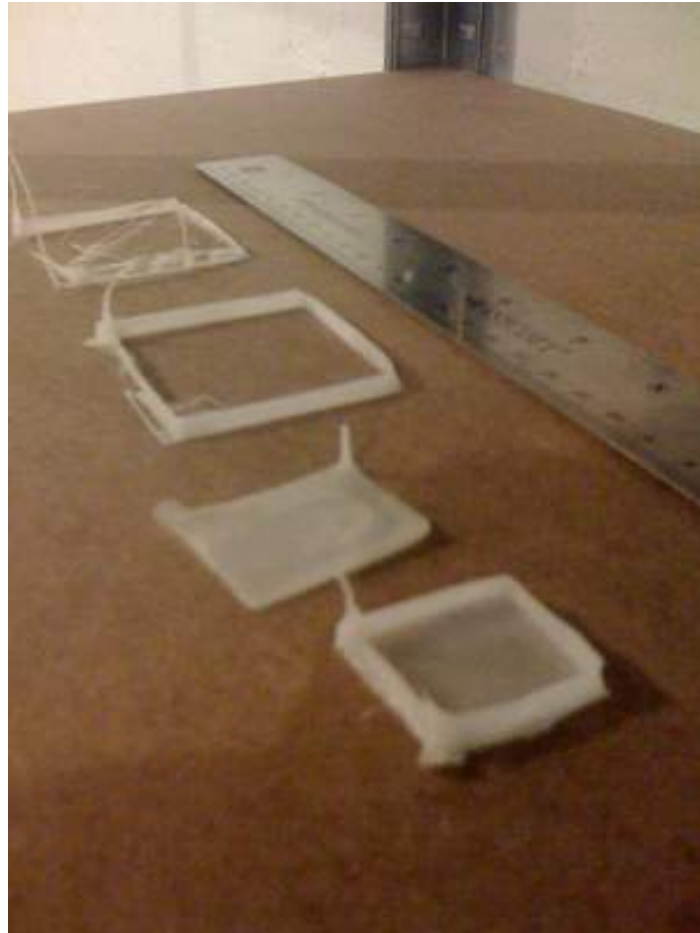

I finally found some time to slog through some code and get my Darwin printing. This print was done using the Arduino GCode Interpreter started by mellery. The SNAP stuff is almost done as well, we just recently found the major bug and fixed it (last night). Hopefully I'll have a minimug to report tomorrow. =)

Anyway, not bad for its tottering first steps.

[Read more on the builders blog entry.](#)

Ponoko's Lasercut RepRap

Friday, 22nd February 2008 by Vik Olliver

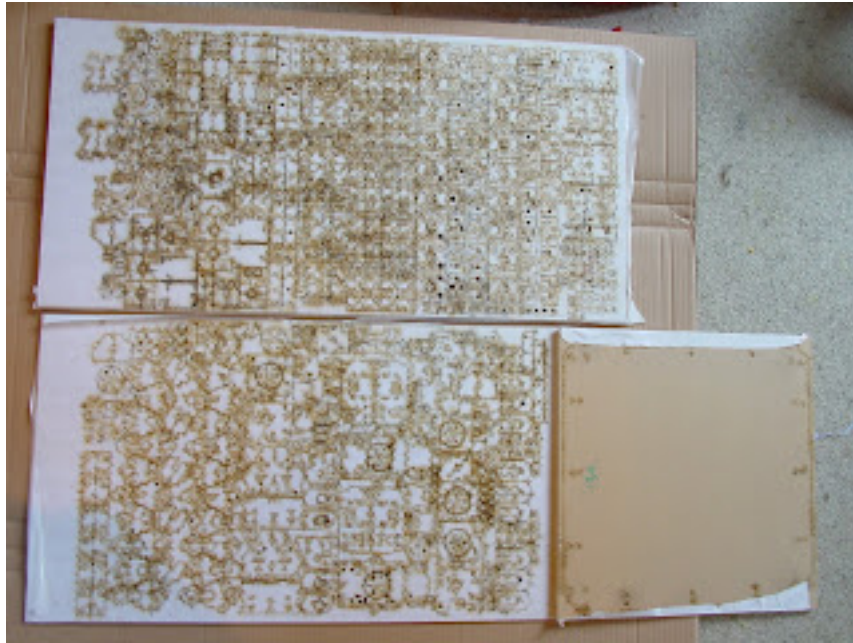

I have something to do while my RepRap is out of action. Toby Borland has done a wonderful design of the RepRap which is meant to be cut on 4mm plywood. He has kindly released the source, and I've converted an early version of it to the EPS format used by Ponoko on their laser cutting and vending service. We're putting the files up there for free use; we're not taking a cut. Ahah.

I've put up the plywood parts separately to the thick acrylic bed; I'll experiment with a 9mm MDF base but it might be too thin. Toby has since sent me some fixes for the plywood parts - already in EPS format - which I'll work in and scale according to how well the first batch of Ponoko parts fit. The files need optimising to reduce the cutting cost (mostly removing double-cut lines) too. Until that's done, the design should be regarded as pre-alpha and non-functional. As it stands, the ply seems to be slightly thicker than 4mm, so a lot of parts don't fit together properly. Oh yeah, I did muck up the scaling in a few places too - mostly ones that matter!

Prepare for strike two, and props to Ponoko for their support.

Vik :v)

Arduino Firmware v1.2 Released!

Friday, 22nd February 2008 by Zach Smith

If you've been following along in the forums, we've been hacking on an epic firmware bug for the Arduino based electronics (available from the RRRF). Well, I'm proud to announce that not only have we defeated it, but in the process I audited nearly every piece of code and removed anything that I thought could have slightly caused a problem. The end result is that the Arduino code is now damn near rock solid. There still might be some slight bugs, and I dare you to find them ;)

For those who are curious, the bug was actually rather stupid on my part. It was related to the interrupt. I created some interrupt code that was set to go off at regular intervals. As this was my first time dealing with interrupts in my code, I had copied some code without fully understanding it. Not only was the code enabling the timer interrupt, but it was also enabling another interrupt... one I had no interrupt handler declared for. The end result: an interrupt handler with address 0 was called (which was the address of the first function) As you can see, this was exactly our bug. A certain set of conditions triggered the undesired interrupt which sent us back to the beginning of the program.

A huge thanks to Marius Kintel for his great catch. If you are ever in Austria, give him a high five and/or buy him a beer. I'm serious!

There are only a couple major things remaining with the Arduino code:

1. forward/reverse commands are not implemented. the single arduino code does not have enough room to hold them (that i can manage to write) the good news is that it may be possible to squeeze them in. also, they are not required to print, nor do i think they are used anywhere. darwinian evolution also means abandoning obsolete things (like tails!) ;)
2. the speed commands are not yet 100% emulated as on the PIC's. currently they are interpreted as RPM. as soon as i figure out how the PIC stuff is translated into time, i should be able to implement it. this is not a big deal, but just though i'd let you know incase someone wants to help.

[Download it from SourceForge!!](#)

Software fixed. Many new special bugs introduced...

Tuesday, 26th February 2008 by Adrian Bowyer

I did a foolish thing. I fixed a bug in the Java host code (in the bit that algebraically simplifies CSG expressions) and, instead of just checking that back in, I also spent some time tidying the code, then tested it, then checked in the lot. That gave Subversion revision 1333.

Unfortunately my tidying introduced several new exciting features that many users would have found not entirely helpful that were not apparent in my testing... Sorry.

Now (with Zach's help - thanks), the code has been reverted back to the version that worked, to which I have applied just my CSG fix.

The current revision is 1369. It's not perfect. But it's a lot better than 1333...

Next thing: fix the memory management...

UV plant-derived resins for RepRap

Friday, 29th February 2008 by Adrian Bowyer

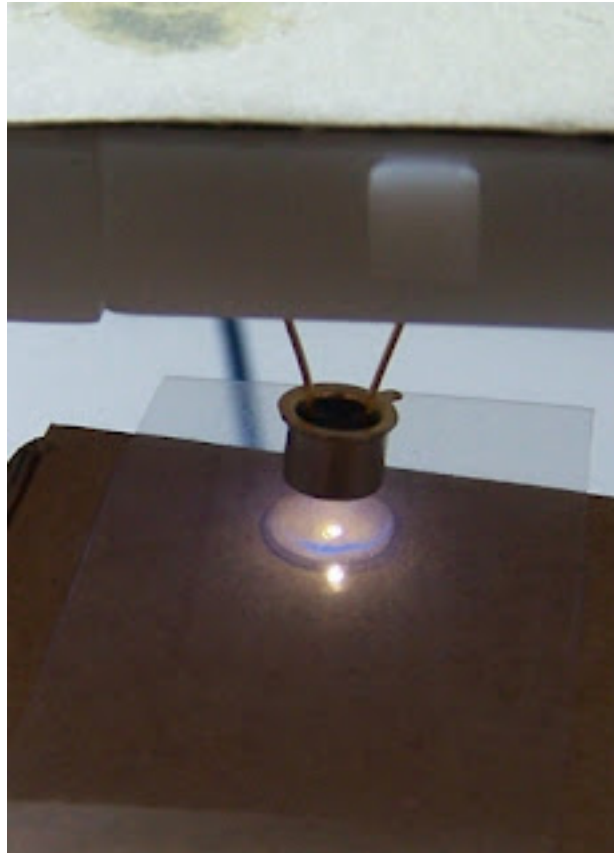

Inspired by [Fernando Mu±iz](#) over on the [RepRap Builder's blog](#) and by meeting Norman Frost of [Sustainable Composites Ltd.](#) (who kindly donated a sample of their UV-cure resin to me) I have been experimenting with thermosets. (There is plenty of time between my tweaking the parameters of my new Darwin as it makes a splodge of polycaprolactone almost resembling a cube.)

The idea is to mix the resin with a glass filler [like this stuff from Tomps](#) to make a paste, and then put that in the [paste extruder](#) with a ring of UV LEDs round its nozzle to set the stuff after it's been laid down.

Norman said that the ideal cure wavelength is 365nm.

The first thing I discovered is that cheapo vanilla 400nm LEDs won't touch the stuff. It just sits there and stays sticky for hours. So then I got some [NSHU550A LEDs](#) that emit at 370nm. The picture above shows one of these zapping a drop of resin about 5mm underneath it using a forward-bias current of 20mA. That forms a thick skin at 10 minutes, and is solid to the touch in 15.

Now. All we need is for each layer to be mechanically rigid enough to support the next, so that should be fine. And, of course, layers underneath will be further hardened as the layers above are laid down, because the UV will percolate down through the resin and the glass.

As you know, we've been working on using polylactic acid in RepRap because it's a plant-source thermoplastic that can be home-made, and when it's finished with it can be locally composted. Widespread use would take CO₂ out of the atmosphere then put it back, and so would be carbon neutral.

But Sustainable Composites' thermosets are plant-derived too. So using that resin to make stuff that gets thrown in landfill rather than recycled would be even better. Thermosets are very stable underground (think amber), so widespread takeup of them in replicating RepRaps would be carbon-positive...

FabLab and RepRap

Friday, 29th February 2008 by Zach Smith

Recently, I became a 'Fab Fellow' at the Sustainable South Bronx Fab Lab. This is very exciting for me, and yesterday I got the chance to actually go up there and use some of the tools. First up was getting a build base for my darwin CNC cut on the ShopBot machine. Check it out:

FabLab ShopBot Demo from Zach 'Iowa' Hoeken on Vimeo.

Darwin@Adrian

Friday, 29th February 2008 by Adrian Bowyer

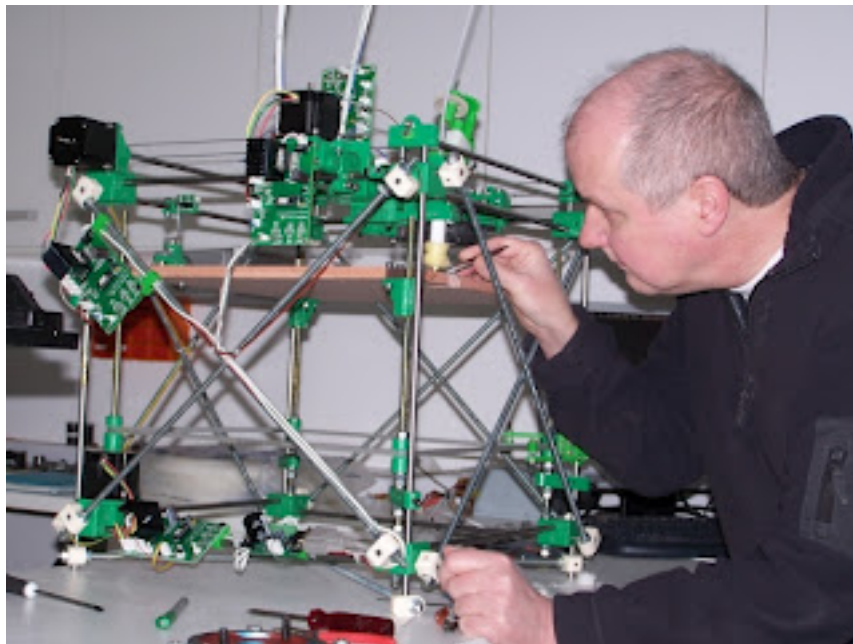

I couldn't really justify using Bath University resources to create a RepRap machine for me to use at home, so I bought a set of PCBs from Zach at the RRRF and a set of resin-cast parts from Ian at Bits from Bytes and put one together from them.

Over two weeks of elapsed time I think it took me about twenty hours work in total. I've copied the properties file from the RepRap that Ed and I have in the lab at the University and am using that as the basis from which to set up my own.

I know that Zach has just got his RepRap machine together too, so we're having a race to the first minimug. Watch this space...

Ratcheted filament driver

Sunday, 2nd March 2008 by Vik Olliver



I had an idea in the bath. To feed the filament, all we need are two ratcheted holes and a solenoid to drive them apart and bring them together. No gears or rotary bearings would be required, and we'd have absolute control over filament driving.

I built this working prototype from two bottle tops, one aluminium and one steel 'cos that's what I could find without having to dive into the kitchen rubbish bag. I drilled a central 2.5mm hole through in the direction I wanted the filament to go (out the top) and cut 4 radial slots out of the hole with a sharp knife about 7mm long. The aluminium one is far too soft. Move them together, filament moves forward. Move them apart or let a compression spring do it for you, filament stays put.

We can change the distance driven, change the timing, and vary the power of the solenoid to change driving pressures. A spring or split washer on top might help even things out.

A similar system might step beaded belts.

Hold on to a static filament and you can step along it...

I shall simultaneously celebrate this idea and obtain another ratcheting component.

Vik :v)

Aligni parts database

Monday, 3rd March 2008 by Adrian Bowyer

The guys at Aligni kindly offer to support open-source projects like RepRap for free. Their software manages a bill of materials for a project along with links to suppliers.

Zach has set up a similar system at parts.reprap.org that works very well, so the RepRap team will stick with that.

But if you'd like to experiment with the Aligni system and the RepRap data from our parts database we (and they) would love to hear how you get on.

Preferences file for the host software

Friday, 7th March 2008 by Adrian Bowyer

Fed up with us pesky developers changing the preferences file all the time, so yours hasn't got the right things in?

Now, if you have debugging turned on, it'll compare your file with the distribution one when the host software is run and report the differences.

I know. Debug is one of the preferences... And, if you have it switched off it doesn't do the check as soon as you switch it on. But it does do it the next time you start the system.

Beaded Belt Drive Success

Friday, 7th March 2008 by Vik Olliver



I've bought some "ball chain" or "beaded belt" from the local Mitre 10 hardware store for NZ\$6.95 per metre. The balls on it are 4.60mm in diameter and have 1.80mm exposed length bars between them. I have plastic beaded belt of the same dimensions, so this is likely to be some kind of standard. Investigations continue, do clue us in.

I've designed a pulley (shown left) that can be fabricated on a RepRap - and made one. After a mechanical test, Adrian ran 4 off on the Strat. Note: Make one with a rim that lifts off in the future so I can fit the damn belt without resorting to violence.

Here is the video below showing them in operation. Note that the orange pulley under the bed in the lower left corner of the frame is rotating and that the old drive belt is not fitted. The red temporary join is a cable tie and is obviously not going to go smoothly around the corners. The chain is made from chromed brass, by the way.



To join the ends of the loop, I filed down the two terminating balls on the chain into approximate halves (measured with a badly-calibrated Mk I eyechrometer) while holding them in medical clamps. Then I held the clamps in a couple of angled vices so that the halves fitted together properly, finally soldering them together with a 30W soldering iron and highly toxic lead solder (yum). Better ideas welcomed! The joined chain is robust enough to turn the whole Z axis assembly with some enthusiasm. When I build the next RepRap the gears will go in the usual place.

Extruder temperatures

Saturday, 8th March 2008 by nophead

I have made some measurements of temperature at various points around my extruder. These are the temperatures I get with my software set to 200°C :-

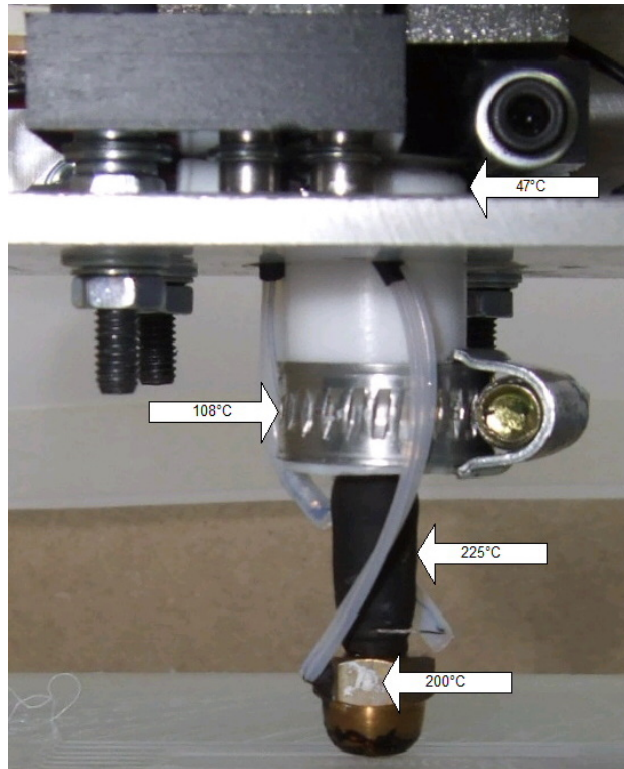

They should be fairly representative as my latest build is now pretty much faithful to the latest design.

One point of interest is that the heater, and the inside of the heater barrel, are quite a bit hotter than the nozzle, where the thermistor is controlling the temperature. That begs the question of what the actual temperature of the extruded filament is, as that is the important thing to control.

I seem to be getting similar results with temperatures that are 20°C below the values I was using with my single piece nozzle. That would suggest that the filament exits at pretty much the temperature of the heater barrel rather than the nozzle. Mounting the thermistor on the barrel rather than the acorn nut is probably a better option.

Blow your nose and clean your teeth

Sunday, 9th March 2008 by Adrian Bowyer

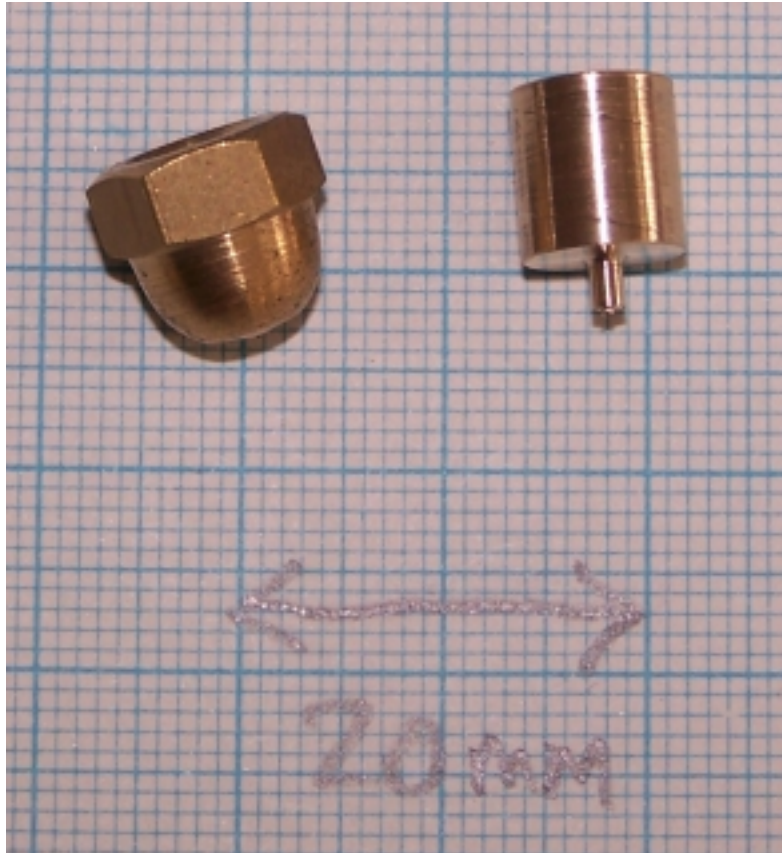

Ed and I have been experimenting with various strategies to improve build quality. One problem is bits of polymer sticking to the head and then dropping onto the build and messing it up. Another is the fact that if you run the acorn-nut nozzle (left above) too close to the surface it smears the molten polymer all over itself, and then re-deposits some of that later where you don't want it.

I made up the nozzle on the right. It is 1.5 mm diameter at the end, with an 0.5 mm diameter through hole. With this in place of the acorn nut, you can run the nozzle over the surface to sweep it flat without pushing the polymer where you don't want it.

It is a bit more complicated to make than the acorn-nut nozzle (which just needs you to drill one small hole in an off-the-shelf part, of course). But it works significantly better.

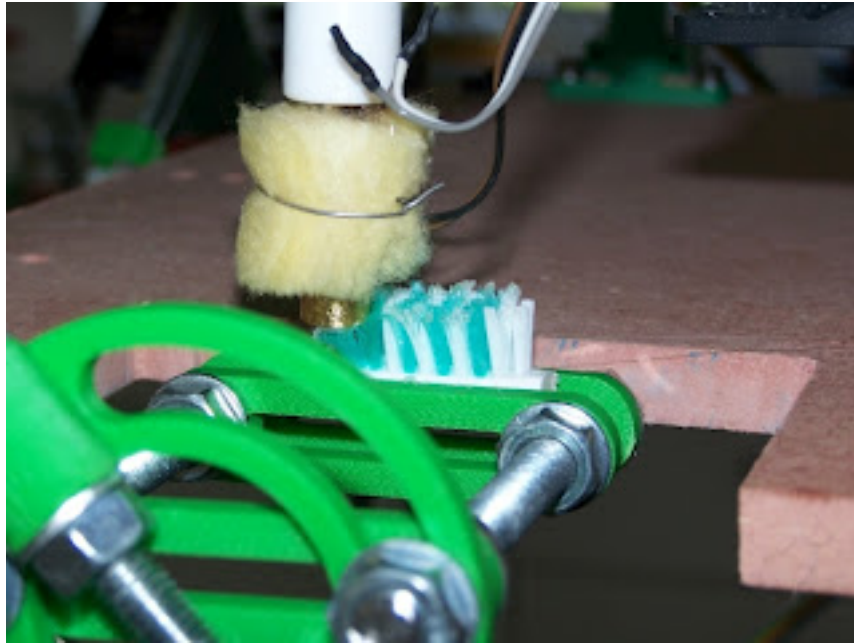

To clean the new nozzle, we've added a toothbrush along with a nose-wipe cycle to the host software. This keeps the crud off the nozzle by wiping it back and forth at the start of each layer.

Now. How do we clean the toothbrush?...

RepRap Segment Pausing Fix

Tuesday, 11th March 2008 by Zach Smith

I've been working a lot on the RepRap code lately and I recently got it to the point where segment pausing is drastically reduced. This RepRap is driven with Arduino based electronics running a GCode interpreter firmware. Woot!

Segment Pausing Fix from Zach 'Iowa' Hoeken on Vimeo.

Update: here's a video from Vik showing the current segment pausing with the PIC based firmware.

RepRap Deposition Showing Pauses Between Segments from Vik Olliver on Vimeo.

ExtruderDelay parameter mod

Wednesday, 12th March 2008 by eD

To give more control over any hysteresis in the extruder I've committed code and two new parameters to the properties.

This means deleting from your properties file:

ExtrusionDelay(ms)_Extruder0=?

ExtrusionDelay(ms)_Extruder1=?

And adding:

ExtrusionDelayForBorder(ms)_Extruder0=1000

ExtrusionDelayForHatch(ms)_Extruder0=1000

ExtrusionDelayForBorder(ms)_Extruder1=1000

ExtrusionDelayForHatch(ms)_Extruder1=1000

Coupling gets too hot

Thursday, 13th March 2008 by Vik Olliver

It's a RepRap day. I like RepRap days - courtesy of [Catalyst IT](#) I get one a week. If anybody wants to sponsor me for another day a week I'd love to hear from you!

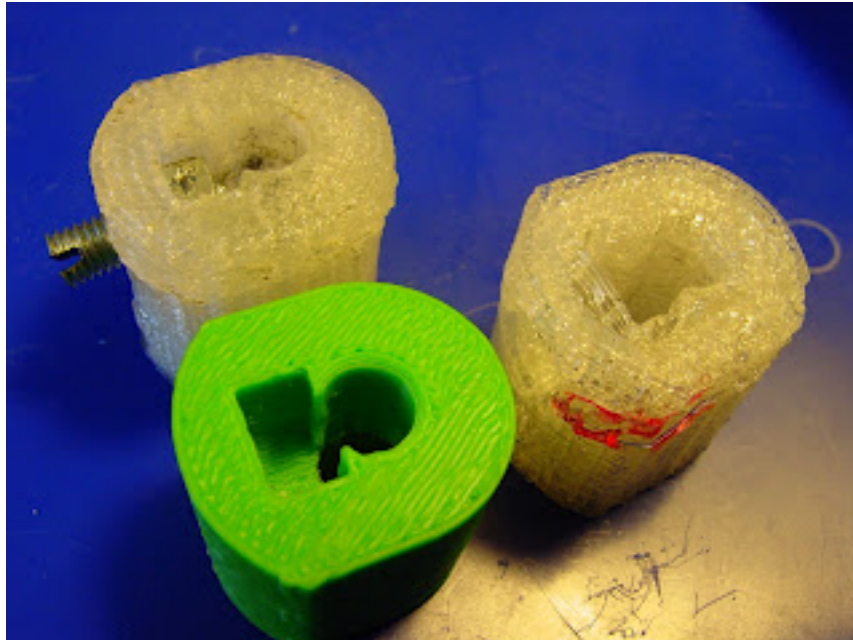

So following on from the saga of the disintegrating Y Motor coupling, I printed out another even denser PLA Y Motor Coupling with yet more plastic in the stressed areas. I can't really continue replication with a straight face without resolving this one way or the other.

At 47C it was showing signs of de-laminating at the 8mm shaft end and the 6.5mm motor shaft started slipping. I tensioned it up once more, but as the temperature hit 60C the PLA softened and was no longer sound enough to hold the motor shaft under tension from the grub. The grub moved, slackened, and the coupling failed to grip the motor shaft once more, this time allowing the shaft to rotate freely. Ugly.

The group photo shows one pristine ABS part in fetching green, one less dense PLA part with a split marked in red, and one showing how the nut & grub go a-wandering when the plastic warms up.

Solutions as I see it:

1. Make the coupling from a higher MP plastic.
2. Cast the coupling from epoxy in a rerap'd mould.

3. Find motors that run cooler.
4. Cool the coupling with a fan or similar.
5. Make the coupling from non-fabricated materials.
6. Try powering down the stepper between steps to lessen the heat build-up.
7. A combination of the above.
8. Something else.

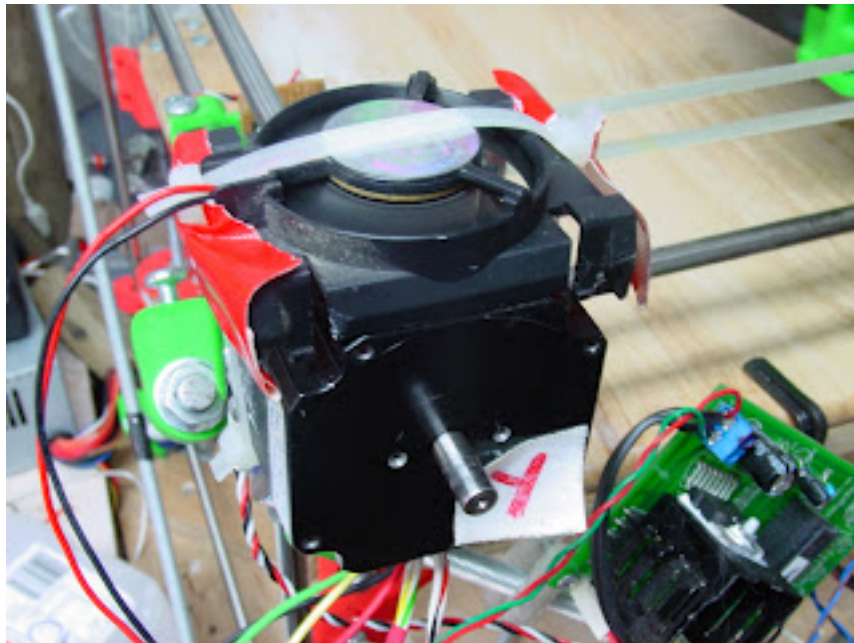

Note that with the X motor we're not having melting problems. The CAPA gear sits directly on the shaft at 51C and is not melting. It's just the Y axis with the problem, probably due to the high load that motor experiences.

So, having a small 12V cooling fan handy made the selection much easier. Number 4 please, Bob! A few cable ties later and some impromptu ducting made from - yes, duct tape, we have the following monstrosity. If my head had been functioning properly this ducting would be under the cable ties, not stuck on top of it but hey.

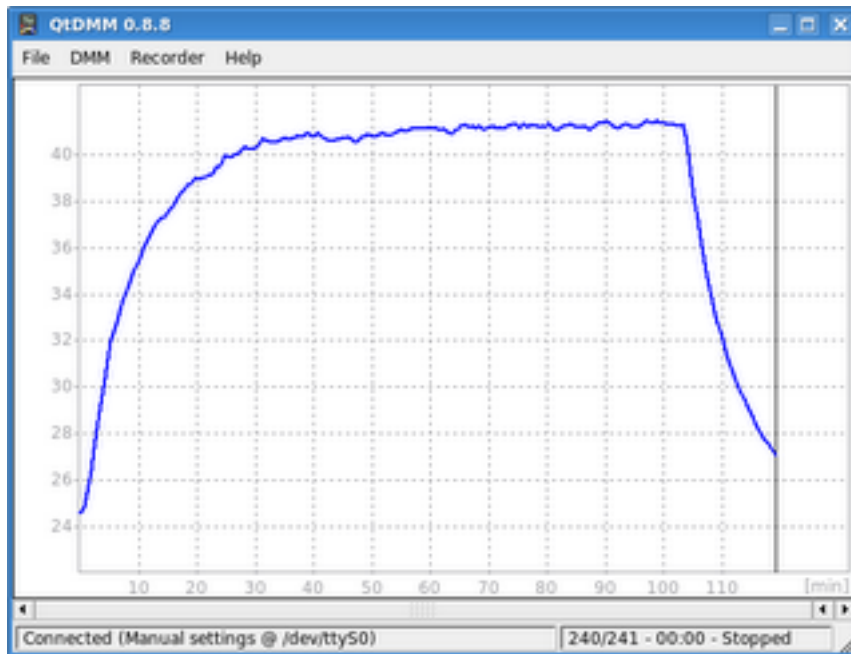

So I've thickened up the coupling design some more, made it taper out, away from the motor end where space is tight, and started printing it while monitoring the motor temperature. So far the Y motor has reached a maximum temperature of 42C compared with the uncooled X casing at 69C, which may be good enough.

As you can see from the graph on the left, the temperature seems to stabilise around 41C under ambient conditions of approx 24C. The X axis snarled, so I stopped and left the trace going for people who like cooling curves. Thanks to Suz for the birthday present of a RS232-enabled QM1538 meter by the way. Very thoughtful of her :)

Vik :v)

While coupling, I killed the X axis

Friday, 14th March 2008 by Vik Olliver

Well, it appears I've been running at speed through good grace & fortune. After doing the graph in the previous post, my X axis belt gear disintegrated. It got too hot. Why pick now? Because the fan I put over the Y axis motor was previously used to cool the extruder motor. That didn't need cooling in the end, so I relocated the fan.

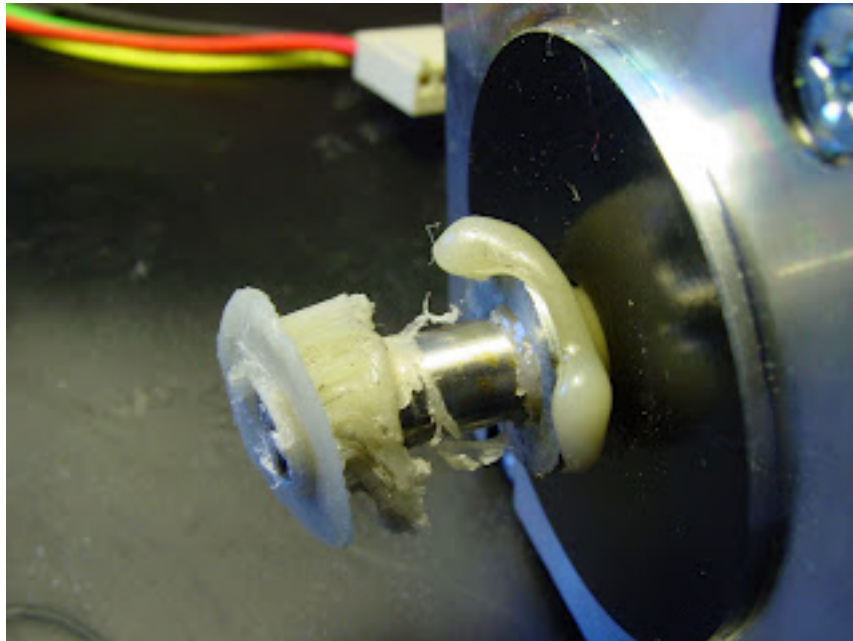

Bad move.

Half of the **exhaust** from the extruder motor cooling fan (installed because it has a CAPA bracket) blew directly at the X axis motor - and kept it below CAPA melting point. Igor move fan. Igor's gear melt.

So, now I have to strip the X motor bracket, make a new X motor gear, and fit a fan to the X motor before continuing. Bugger, as we say in New Zealand. Positive outlook: I've shown fans do stop CAPA RepRap parts from melting, and there is still cold beer in the fridge.

Vik :v)

Doctor blade

Saturday, 15th March 2008 by Adrian Bowyer

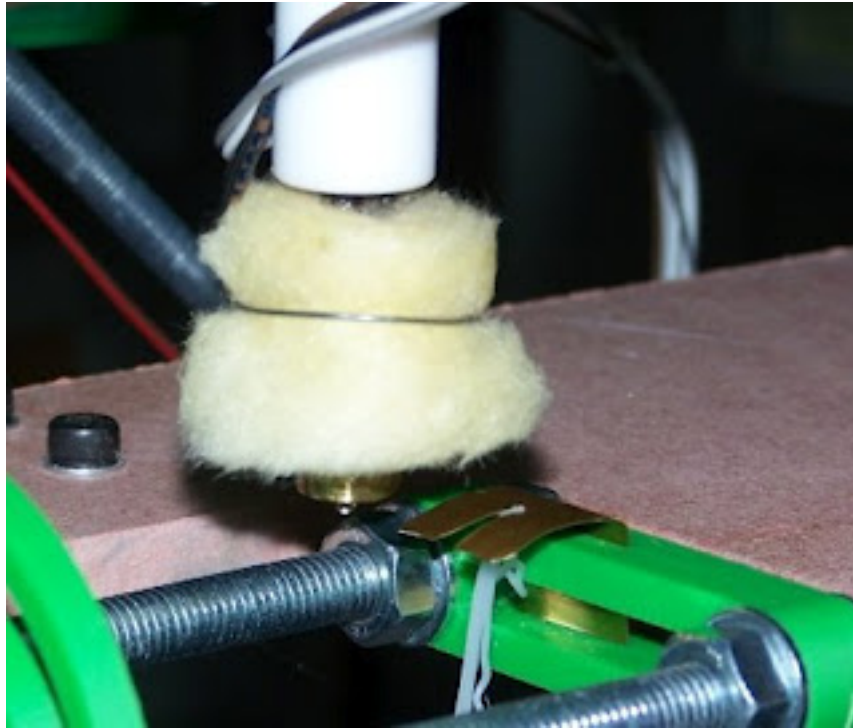

After looking at the cool stuff nophead is doing, and stealing an idea from Ed, I have improved the nozzle wiping on my RepRap considerably.

The picture shows a doctor blade cut with scissors from brass shim. It has a V notch that the extruder uses to discard excess extrudate.

I have upgraded the Java code in the repository to use this type of wiper, which works better than the previous toothbrush-wiper blogged a few days ago.

Tricks: make the V angle very acute, and curl the profile down slightly so it comes up to meet the nozzle as the nozzle moves over it. Also take care to align the nozzle with the very centre of the notch when it does the wipe.

We still need a way to clean the cleaner, I think. As you can see, lengths of extrudate build up in the notch and are going to cause trouble eventually.

Coupling Issues Solved

Sunday, 16th March 2008 by Vik Olliver

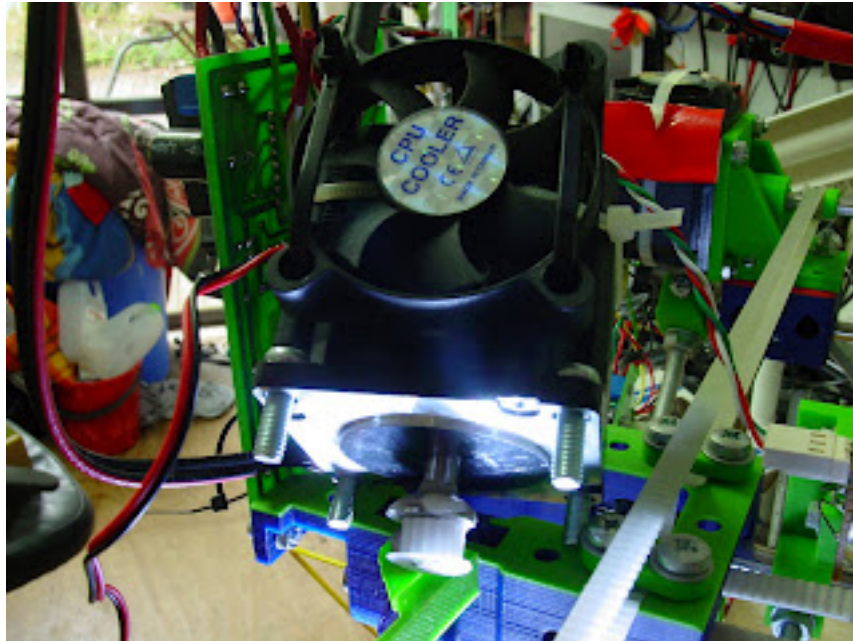

I've replaced the X belt gear (hand-moulded perfectly first time) and strapped an old CPU fan onto the stepper. That takes care of cooling the X axis. Following that repair, I successfully printed a modified Y Motor Coupling and fitted it to the Darwin RepRap.

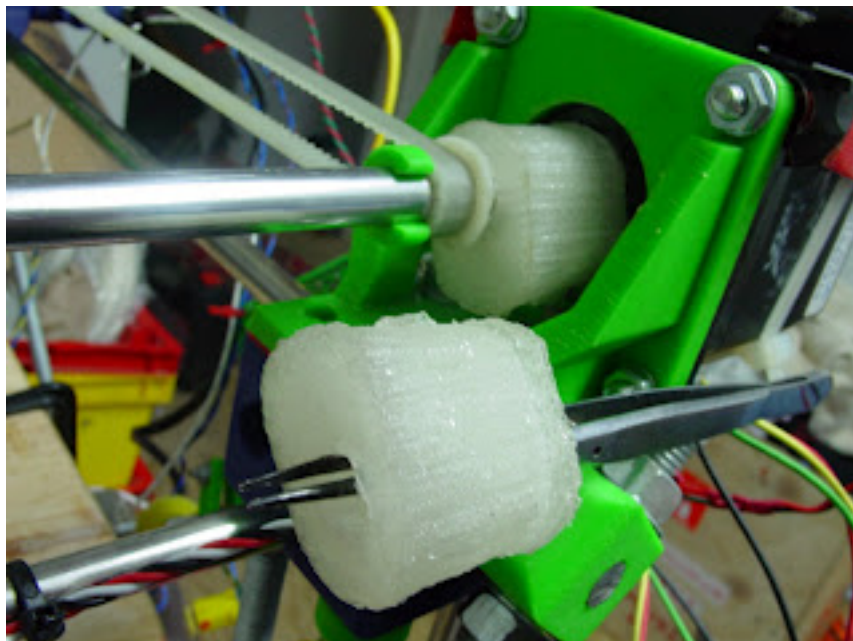

Using the new part, I then printed another identical coupling - so we know it lasts long enough to at least replicate itself. Note that the end away from the motor is somewhat thicker and there is a ridge running between the two grub screw holes. Here is one propped up by the working coupling on a pair of tweezers. Temperature graphs show motor temperatures halting below 45C, so the

coupling issues seem solved.

The End?

Vik :v)

Nozzle Cleaning Part Deux

Monday, 17th March 2008 by Adrian Bowyer

RepRap doctor blade in operation from Adrian Bowyer on Vimeo.

The doctor blade I blogged below is a sharp V notch which you run the extrude head over once to clean it. This works really well, but the extruded junk builds up in the V. So this little lever, nudged by the extrude head before it cleans itself, cleans out the last bit of extrude junk. As you can see, this one is made from bits of scrap plastic. We'll ad an RP version to the RepRap design soon.

A high temperature extruder?

Monday, 17th March 2008 by nophead

I made a quick lash up which shows that it is feasible to replace the PTFE heat barrier with a short stainless steel pipe and a heat sink. That will allow the extruder to operate easily over the full temperature range for thermoplastics and make it far more mechanically stable.

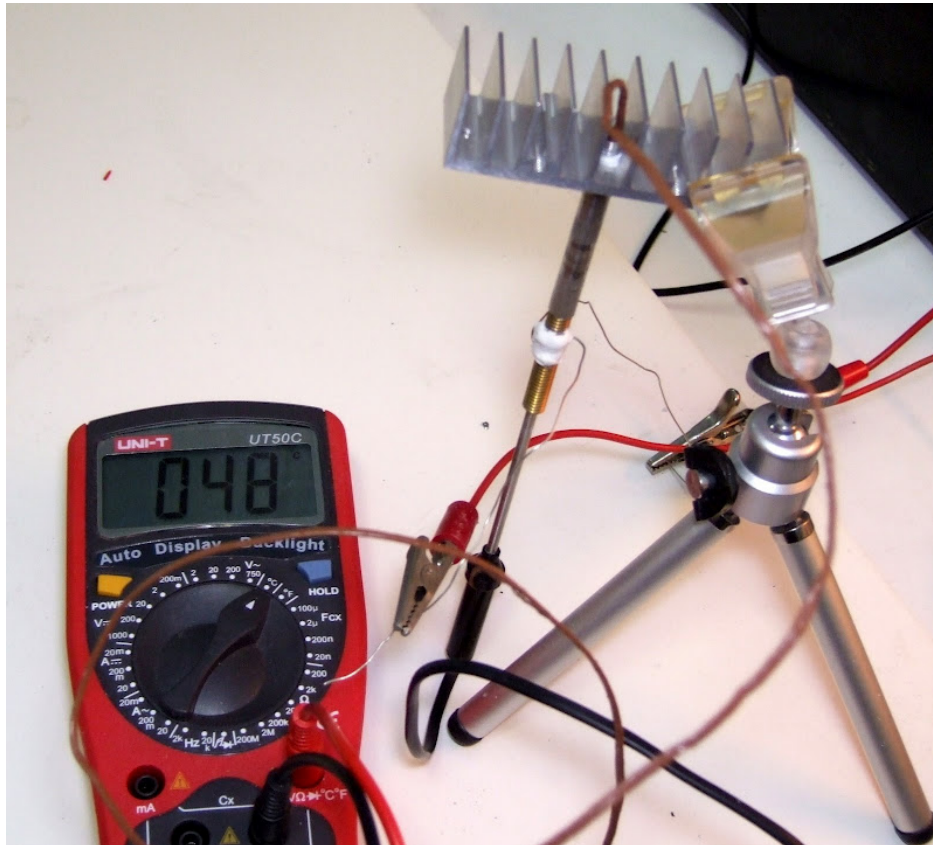

More details here: hydraraptor.blogspot.com/2008/03/high-temperature-extruder.html

More Nose-Wiping Action And A Boo-Boo

Thursday, 20th March 2008 by Vik Olliver

I've upgraded to the latest code (SVN #1428 at time of writing), and rediscovered why we're turning the extruder on and off a lot. In this video we see the extruder nozzle go to my hand-made Meccano nose-wiper, nicely clean itself, then shoot off on the Y axis at X=0. After turning on its extruder feed, the nozzle builds up a nice thread of goopy plastic en route to where it really should be printing, and wipes it off on the workpiece. Charming.

Finally, after printing out a Y motor bracket looped with festive decorations, the RepRap software drove the Z axis back to zero, pushing the workpiece through the cooling fan and kindly lowered it again to show off the damage. Did someone say holiday? Oh, good.

Vik :v)

Yet Another Minimug

Sunday, 23rd March 2008 by Adrian Bowyer

Having spent a while tweaking the parameters of my Darwin on a 10mm test cube, I decided to go for a minimug:

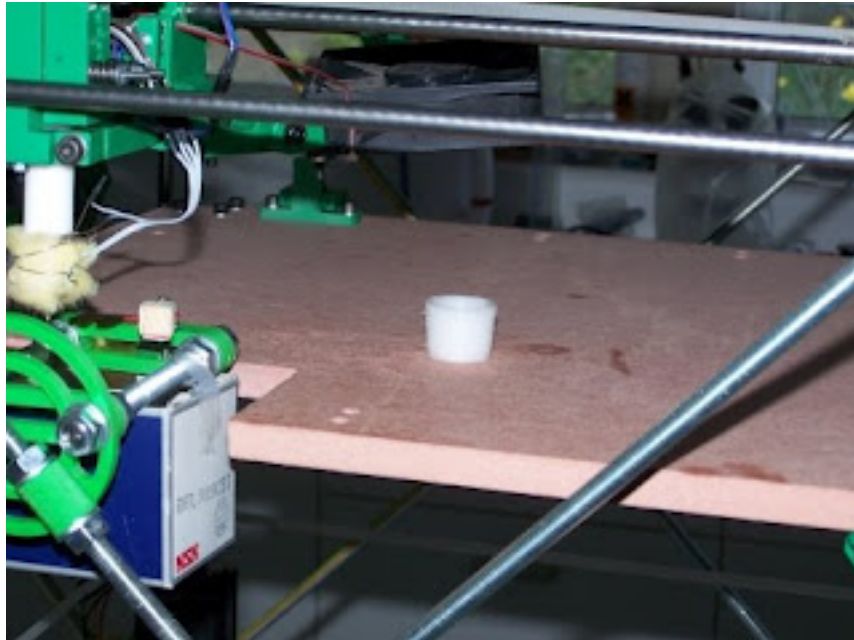

Which worked. My daughter Sally was home for Easter and so joined in the celebrations, which consequently had to involve Amaretto - slightly sweet, if you ask me:



In for a penny, in for a pound: I then decided to throw a Darwin opto-switch bracket at it:

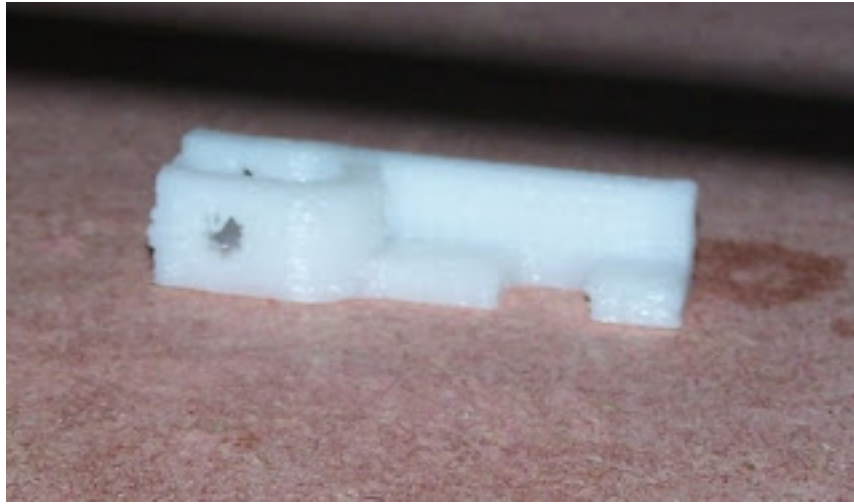

While it was printing, I soldered up a quick opto-switch PCB. Then I took the bracket off the build bed and ran a drill bit by hand down a couple of the holes to clean them up. I bolted the assembly together.

Finally I attached it to the very same extruder that made it:

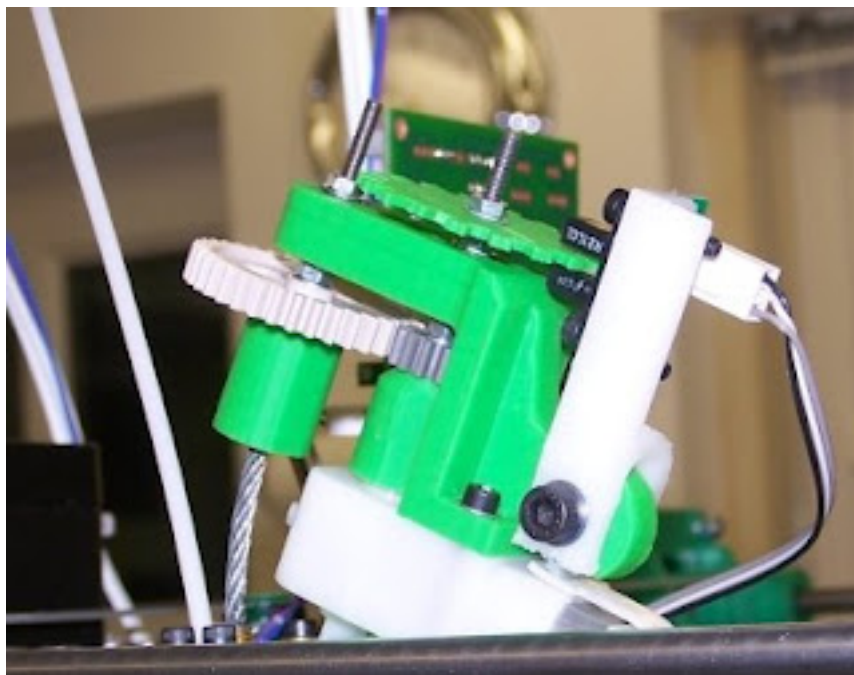

That extruder now has speed feedback. Job done.

*That's*what I'm talking about...

Replacing in-situ

Monday, 24th March 2008 by Adrian Bowyer

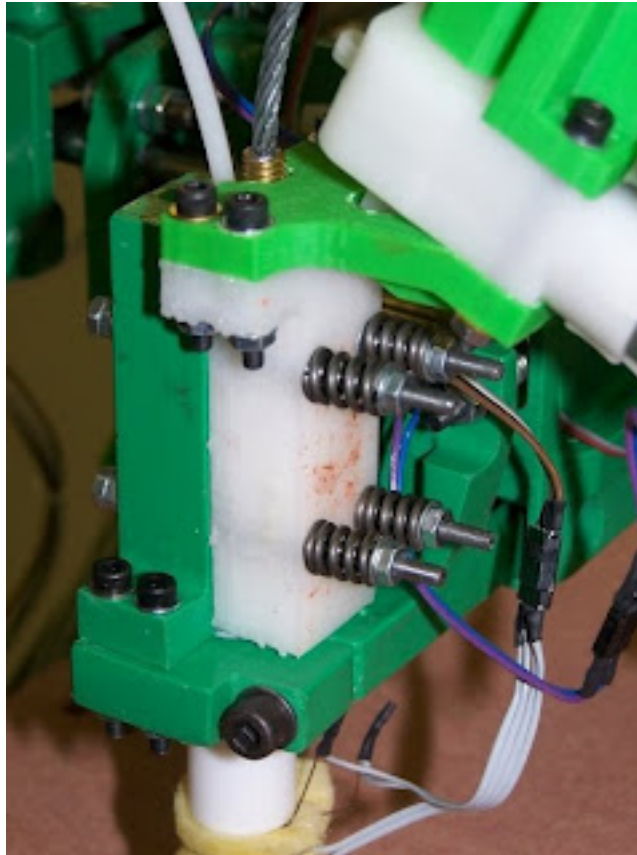

Buoyed up by yesterday's success, today I set my Darwin making the screw-drive holder from the extruder. It took about three hours, so I think I need to make some speedups, but it came out well. There were a few PCL strings from the extruder in-air movements, but a slash of the scalpel did for those. Again, I ran a drill by hand through the holes to clean them up.

Then for the acid test. I took the old screw-drive holder from the extruder, put it to one side, and bolted in the new one that it itself had just made. I warmed it up and turned it on and out came the extrudate stream :-) :-)

I didn't even have to change any of the settings to get it to work the same as the old one.

Now to see if I can catch up with that pesky Vik bloke...

Arduino chosen for next stage of RepRap development

Saturday, 29th March 2008 by Adrian Bowyer

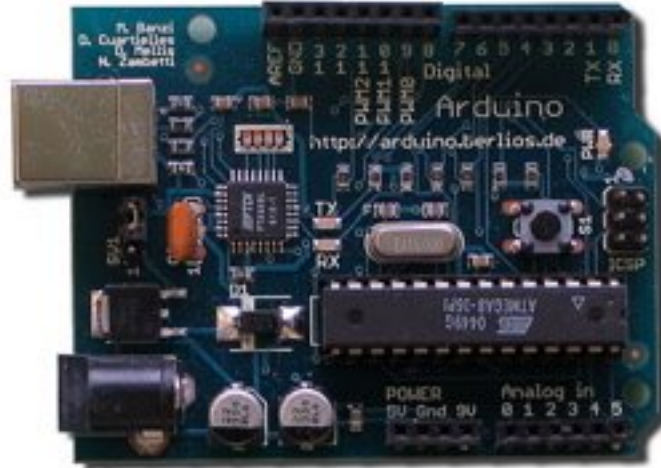

We have chosen the open-source Arduino microcontroller for the next stage of RepRap development. Zach has been working on this for a while, and it gives a number of advantages:

- Direct USB connection to the host computer, hence no significant communications delays
- Easy-to-use platform-independent software development environment
- Faster
- More memory

In addition, we have stepper-driver boards for it that allow RepRap to use much less expensive and more easy to obtain stepper motors than the current ones.

We shall do a release of the entire RepRap system (hardware, firmware, and software) shortly that will be a stable platform from which people can take the current PIC microcontrollers forward if they wish.

We will then do a subsequent release with identical host software, but with the Arduino electronics and firmware. This will form the basis of our next set of developments.

Serendipity

Sunday, 30th March 2008 by Adrian Bowyer



The MDF base of my Darwin is getting a little worn where I keep building experiments on it then ripping them off. I decided to bolt something sacrificial onto it to build upon. I had no more MDF, but I did have some balsa wood so I tried that.

It works really well. Above is the X-axis PCB holder. Even with PCL this has a slight tendency to curl up at the ends because it's so long and thin. But with balsa wood, no such problem - it builds perfectly. It works especially well if you run the first layer a little low. This causes the extruder to force the polymer into the grain a bit, giving good adhesion. But the balsa is so weak that it's still easy to separate the built part (though some bits of balsa come away with the part, they are simple to clean off with your fingernail).

Here are two of the general PCB brackets built in one build:



I made a little aluminium template to cut the balsa round with a scalpel and to act as a jig for the holes through which I bolt it to the base. And, as it gets a bit tatty, you can double its life by turning it over, of course.

New Board: Thermocouple Sensor v1.0

Wednesday, 2nd April 2008 by Zach Smith

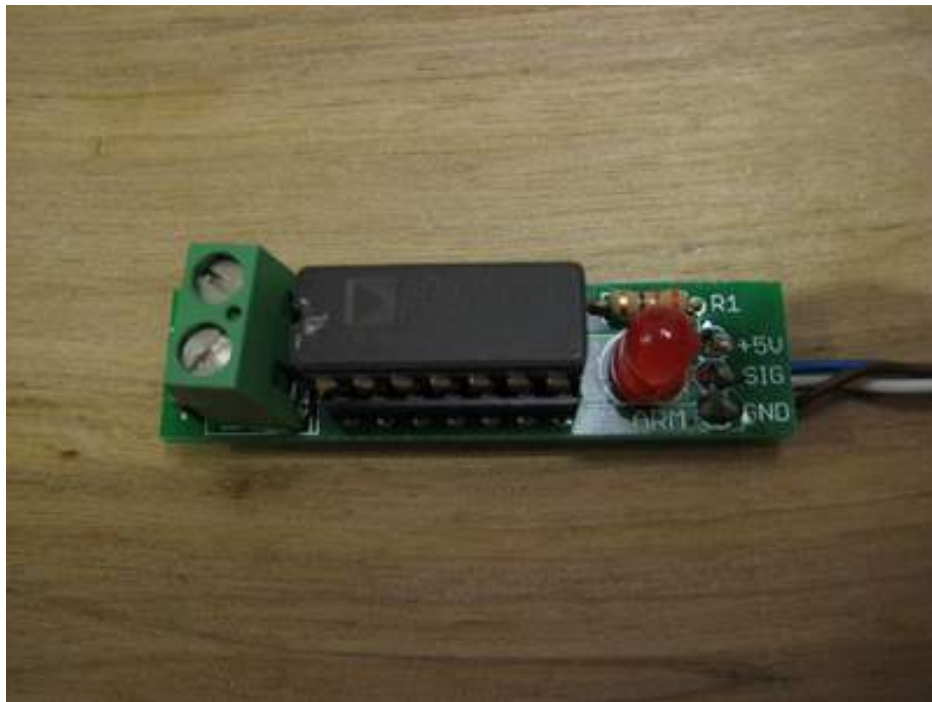

This new board is a cool, 'experimental' temperature sensor based on a Type K thermocouple, and the AD595 chip. It is very useful. It makes temperature measurement really easy, can easily measure up to 500C with the Arduino (up to 1300C with a bit of extra work). [Read about it on the wiki.](#)

It's not an official set of RepRap electronics, but can easily be integrated with the Arduino code. This board is intended for people who are interested in doing advanced research, are fed up with thermistor problems, or just want better temperature measurement.

It's available now from the [RRRF store](#) (kit coming soon!)

New Board: Arduino Breakout v1.1

Wednesday, 2nd April 2008 by Zach Smith



I recently finished a new board for the RepRap arsenal: its a 'breakout shield' for the Arduino that gives you screw terminal headers for all the pins (as well as extra terminals for all the voltages/gnd.)

Its quite useful, and available from the RRRF store (kit coming soon!)

Z Motor Adaptor Plate

Thursday, 3rd April 2008 by Vik Olliver

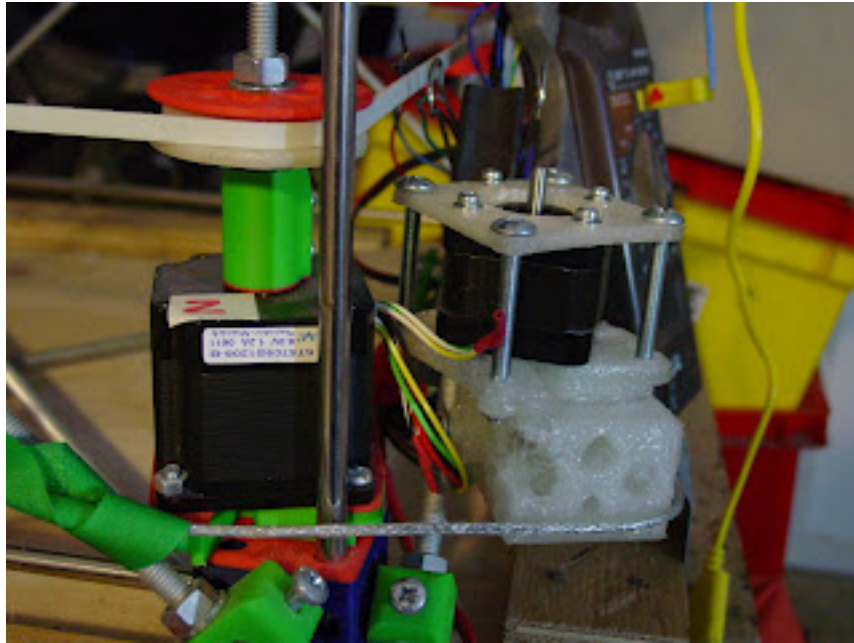

I've made an adaptor plate (it's in [SVN](#)) to allow single shaft stepper motors to be used on the Z axis. It's not a tricky part - you could hack it out of plywood or aluminium fairly easily if necessary. There are also slots in it to allow the mounting of smaller stepper motors, though I don't know yet if they'll turn the Z axis - we'll find out when I get the drivers for the Arduino stepper board.

The incarnation shown in the photo bends a little when fully stressed up, so I've thickened it by an extra mm since then.

Yes the corner bracket is fairly crappy, but the crappy side isn't used on the Z axis' corner so I'm using it anyway and saving myself another 7 hours of printing.

Vik :v)

RepRap extruder does ABS

Friday, 4th April 2008 by nophead

Acrylonitrile butadiene styrene (ABS) works really well in the RepRap extruder. Its melting point is 105°C which is less than HDPE so it does not stress the extruder as much thermally. It is harder than HDPE and PCL so it is quite tricky to get enough motor torque without the clutch slipping. Loosening the top springs on the pump and tightening only the bottom springs helps as well as lubricating the filament with oil.

Its warping is a lot less than HDPE and a bit more than PCL, but the main advantages are that the die swell is low and the filament is very compliant. It follows the head movement accurately even when extruding 0.5mm filament at 16mm/s. That gives objects good definition and sharp corners.

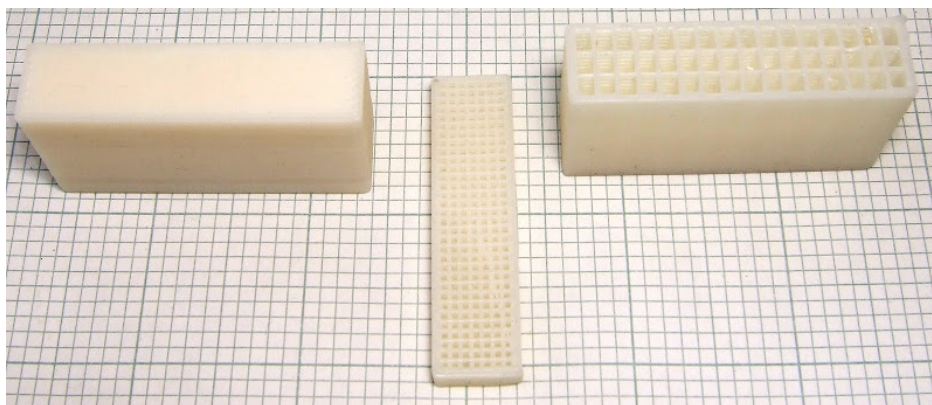

It is also much harder than the other two plastics and makes very rigid objects.

Read all the details here: hydraraptor.blogspot.com/2008/04/absolution and for comparison my evaluation of PCL is here: hydraraptor.blogspot.com/2008/03/chalk-and-cheese.

Ponoko.com lasercut kit, strike 2

Friday, 4th April 2008 by Vik Olliver



The folks at Ponoko are being very patient with me and have run off a second attempt at getting the RepRap printed out on their laser cutting service. I'm not as good at this as Toby Borland who did the original lasercut conversion. Ponoko did their job fine; I goofed again, hence a few nibbled edges in the photo where parts *almost* fit together.

But this run also produced parts that DO fit together. We also managed to include 2 x 9mm MDF baseplates with cutouts for the wiping mechanism (no mechanism bits yet though) instead of just one in acrylic. I used the cutout space to print some test parts in that normally would require laminating. If they work, that'll save money and effort as you pay per cut and we can get the kit cost down further. I think we shaved US\$40-50 off the previous run, and I hope to do the same again.

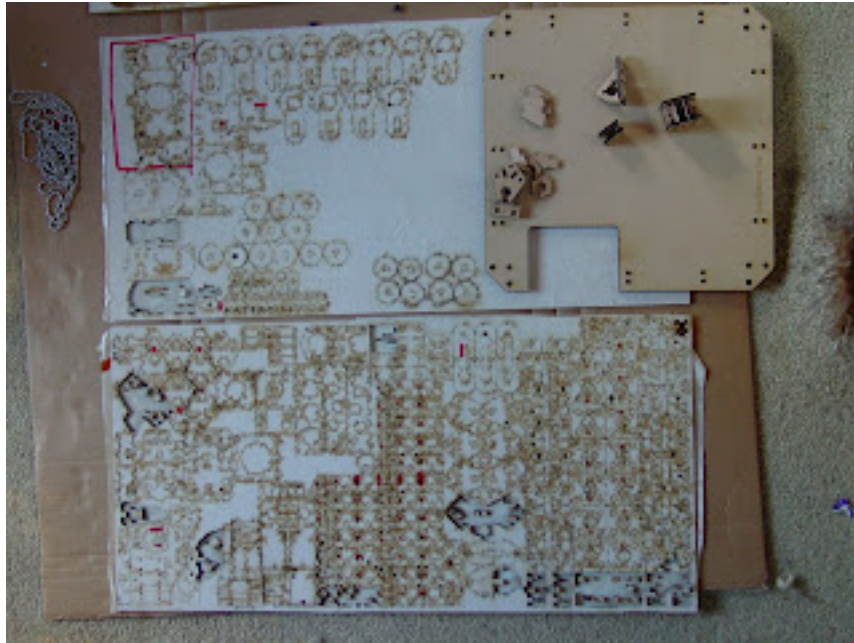

Most of the parts now have helpful little labels etched onto them, letting you know which tab fits in what slot. One of the more interesting set of goofs is that I accidentally told the laser to cut some lettering right through (and vice versa where some cut lines are only etched). So if you see lettering on the reverse of the cut sheets, you know it's a bad sign (marked in red on this photo, dropped sweet wrapper marked in blue). Maybe they parts will work if the 'D' and 'O' gaps are loaded with epoxy...

The ball-chain gears look like they'll work for 90 degrees of drive - just. I'll tweak them a bit more, and thicken the base of the gear teeth where the laser cut more than I thought it would. All being well, I'll be talking to the awfully nice Ponoko people in a week or so to run my third - and hopefully final - prototyping run. Meanwhile, I have what feels like a 1,000 piece 3D jigsaw to assemble and I have to correct the bits that don't fit!

Vik :v)

PS Missed the Y carriage out altogether Garrrr!

Granule extruder

Sunday, 6th April 2008 by Adrian Bowyer

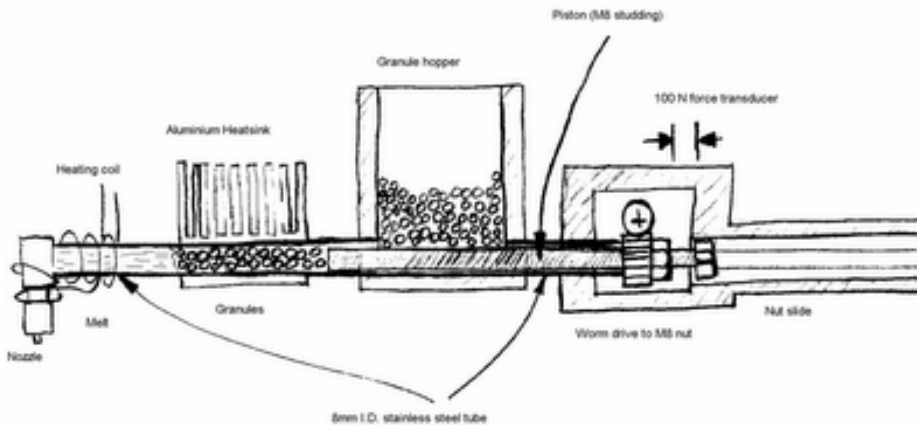

click the pic to get one big enough to see...

A couple of days ago Zach and Nophead independently came up with two important insights. Zach's was that, in order to make a granule extruder, you don't need a complicated auger to move the granules forward; you can just use a piston, like a syringe. Nophead's was that, if you want a tube that's hot at one end and cold at the other *and* strong you could use stainless steel (which has a very low thermal conductivity for a metal) and slap a heatsink on it at the point where you want it to go from hot to cold.

This prompted me to sketch out the above design for a granule extruder. The extrude nozzle is on the left, made out of a brass fitting screwed to the 8mm I.D. stainless tube. We wrap nichrome heater wire round that and that end of the tube to cook them up (there would also be heat insulation round this section - not shown).

A bit to the right is the heatsink, which gives the transition from hot to cold. Around here the polymer should go from a melt to granules. This phase boundary is important, because it is here that air bubbles get more-or-less automatically excluded.

If we can easily get 8mm internal diameter stainless tube (anyone know where?), we can just use a length of the standard 8mm studding that forms Darwin's frame as the piston. The piston stays cold at all times; when it gets near the melt region (detected by an optoswitch- not shown) it is retracted and a new charge of granules falls in front of it from the hopper.

Recently Ian measured the force needed to push polymer through our standard 3mm filament extruder- it was about 10 N. This means that this device should need about 70 N to give the same pressure. The drive is a worm gear turning an M8 nut against a force transducer that measures

that force.

Flow has to be controlled by force rather than the distance the piston moves, because the melting of the granules into the melt is an unpredictable process. [Also one potential problem with this design may be overrun: even when you take the pressure off, the nozzle may continue to extrude for a while.]

At the right hand end is a nut running in a hexagonal channel. This is soldered on the end of the M8 studding and stops it rotating.

I think the whole thing needs to be horizontal rather than vertical (which might be mechanically simpler) because my earlier granule extrusion experiments showed that the mere convection of heat up the tube was enough to melt the polymer all the way up. But a simple experiment with a heated tube and heatsink full of non-moving granules should show if it really does need to be horizontal.

I'm off to the Go Open 2008 Conference in Oslo in a few hours to spread theRepRapword. I'm back next weekend, when - unless anyone can think of a good reason why this won't work - I might try to put one together.

I'm also experimenting with a very very simple design for a field's metalextruder for electrical circuitry that's waiting for the transatlantic postman to lay some insulated nichromewire on me from the RRRFStore.

Watch this space for news on both when I get back.

Hello Slashdotters

Tuesday, 8th April 2008 by Vik Olliver

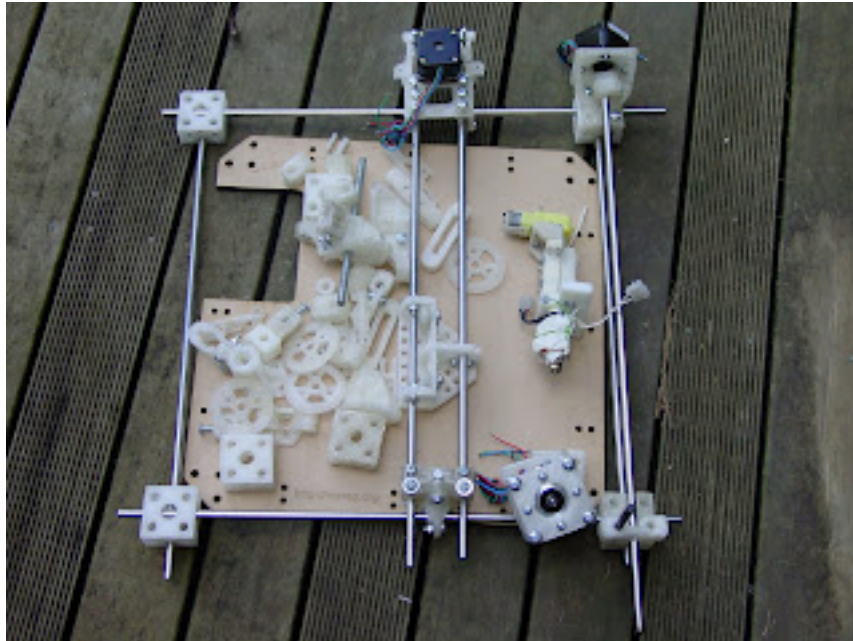

We've been Slashdotted thanks to an article in ComputerWorld. A quick update on the state of play: I have now fabricated all the parts of the RepRap except the Z flag which is probably easier to just cut out of the side of a beer can. I've taken delivery of the steel rod for the frame, and the driver parts from Jaycar turned up this morning. So, all systems are go - except I have to be in Wellington for the next two days. The suspense is killing me!

GPL Note: Yes, we know the GPL doesn't cover hardware. That's why we're releasing hardware "In the spirit of" the GPL. We know about TAPR but it's not right for us at this point. It's complicated.

Vik :v)

A few thoughts on warping

Wednesday, 9th April 2008 by Forrest Higgs

Recently, Chris (nophead) has been doing yeomanry duty in sorting out the problems associated with printing the various polymers that we hope to use while the rest of us worry about other issues. He recently published this little graph...

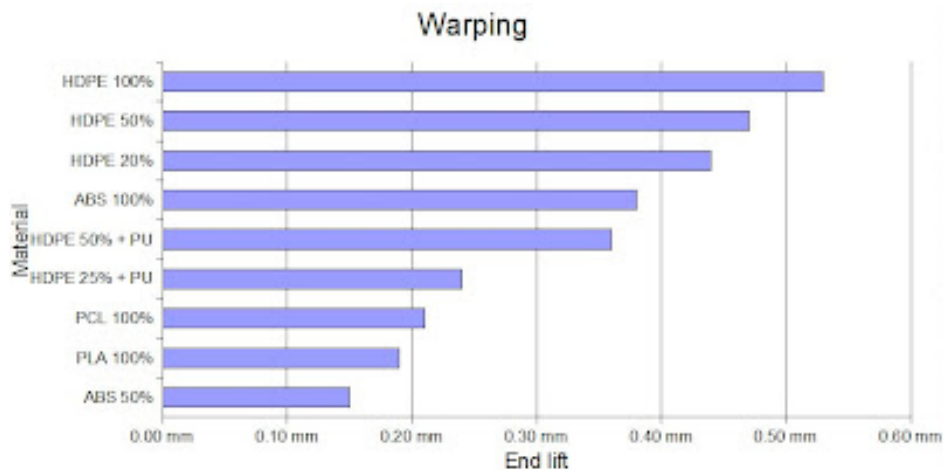

The chart displays the amount of upward curling that could be expected from various polymers printed at several fill percentages at each end of a 40 mm bar with, iirc, a 10x10 cross-section.

Chris, if I've understood correctly, has been doing such tests with the notion of identifying polymers and fill rates which give the smallest amount of warping after they've been pulled off of a printable surface.

I've been toying with the idea of trying to correct for warping by printing on a convex surface. The brute force approach to this would be to develop a mathematical model for warping and then design a support rick for a particular piece that we wanted accordingly. This morning, however, I am wondering if we could simply center any print on a standard convex support rick, the curvature of which would be determined by the polymer being printed.

It would seem that the first idea to test would be to try to print Chris' standard bars on top of a loose-fill support rick that corrected for the expected warping. If that worked a few other issues would have to be looked at.

The first would be whether the aspect ratio in the xy plane made much of a difference to the curvature of the rick. If it didn't it would seem that we should double the width of Chris' standard bar a few times to get the shape of the convex curve of the rick.

The second would be to see if the depth (z dimension) of the printed object affected the convex

surface curvature as well.

It would really be nice if we could get by with a standard convex support rick for printing parts of a particular polymer. It would certainly make life a lot simpler.

(No additional content at 3DReplicators.com)

RepRap in Oslo

Saturday, 12th April 2008 by Adrian Bowyer



With lots of hand-waving, obviously...

I was asked to give a keynote at Go Open 2008 in Oslo. The conference had other keynotes from the likes of Chris DiBona, the Open Source Program Manager at Google, and Simon Phipps, the Chief Open Source Officer at Sun. RepRap was well-received, and the conference as a whole was both very good and very well-organized. There should be a video, which I'll link from the RepRap video page as soon as it is available.

I had a little spare time, which I used to make contacts with a group who are concerned to shift free technology into the developing world (more on that if we can set up a collaboration), and also to make friends with a local:



Some estimates...

Saturday, 12th April 2008 by Forrest Higgs

Assuming that the convex surface of warping is spheroidal and assuming that Chris' measurements for warping on his 40x10x20 mm test block were taken at the extreme midline rather than the corners I come up with a radius for the spheroid of 425.3 mm for the warping of 0.47 mm for his 50% fill HDPE test block.

If that is meaningful then if Chris printed a 40x40x20 block of HDPE at 50% fill one would expect that the curling at the corners which would have a distance from the block's centroid of 28.8 mm would be about 0.94 mm. The warping at the midline would remain at 0.47 mm, of course.

(No additional content at 3DReplicators.com)

An iPod in your Ford

Monday, 14th April 2008 by Adrian Bowyer



My wife Christine bought a cheap iPod mount that clips into the air vent on her Ford Fiesta. But that means that she can't use the air vent, plus the iPod gets cooked when she has the car heater on.

The dash also has a place to clip coins in (presumably for bribing traffic policemen...) that she never uses. So I designed one of these in Aol and made it in my home RepRap machine:

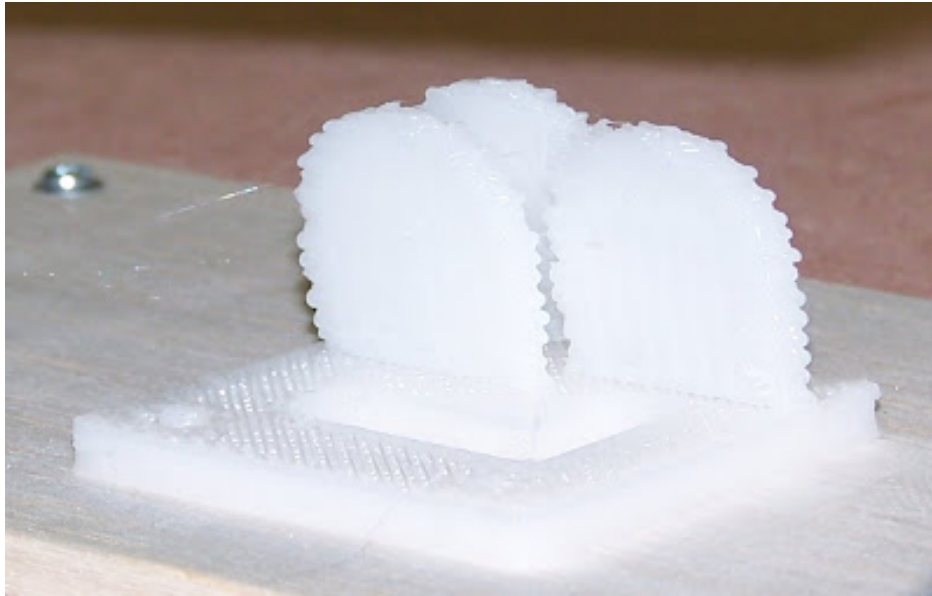

It pretends to be three coins in the right places to fit in the coin-clip, plus a bracket onto which the holder can be bolted. The picture at the top shows it working.

The tombstone coins are a bit woolly as I'm just back from Oslo and didn't have time to reset my machine from the experiments I was doing before I went away.

Also see a blog from Ed and Ian on controlling polymer flow shortly...

The design for the bracket is [in the RepRap repository here](#).

Anti-ooze

Tuesday, 15th April 2008 by eD

Anyone who's putting polycaprolactone through their extruder will appreciate what ooze is. It's the four or five second dribble of extrudate that continues to come out of the nozzle after the motor's been switched off. This extra material has the potential to mess up a build, and it does my head in. Simply reversing the motor would help to a point but ramping pressure up and down implies a lag. So what we need is a valve.

Here's my original idea, the ball valve section is actually a cylinder which runs through the nozzle to a lever and solenoid:

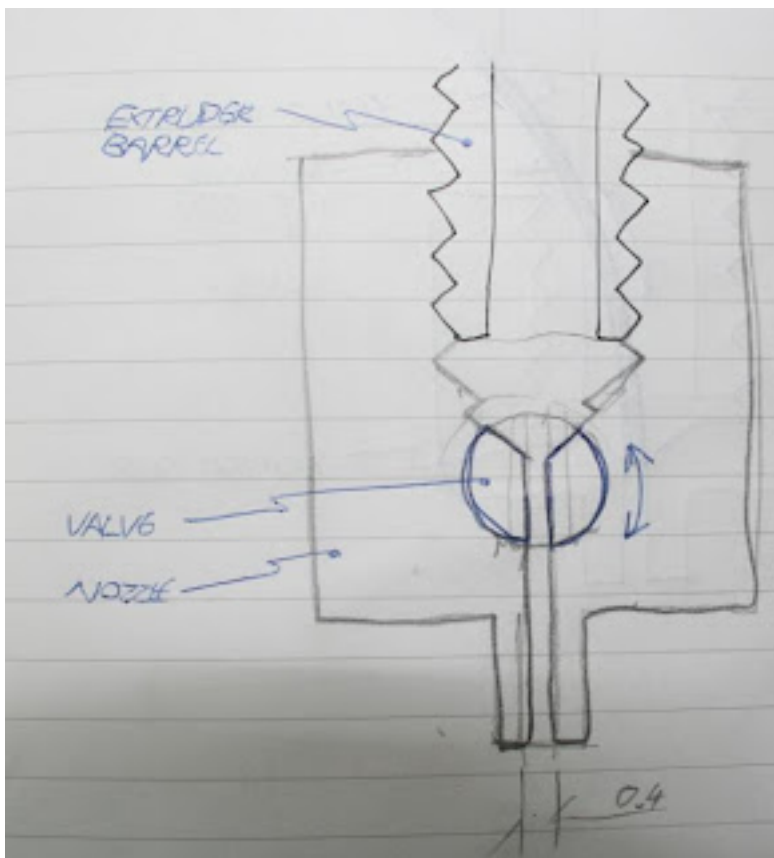

It suffers from leak potential and precision machining. It took this to Ian and he had a much better idea... a washing machine style valve:

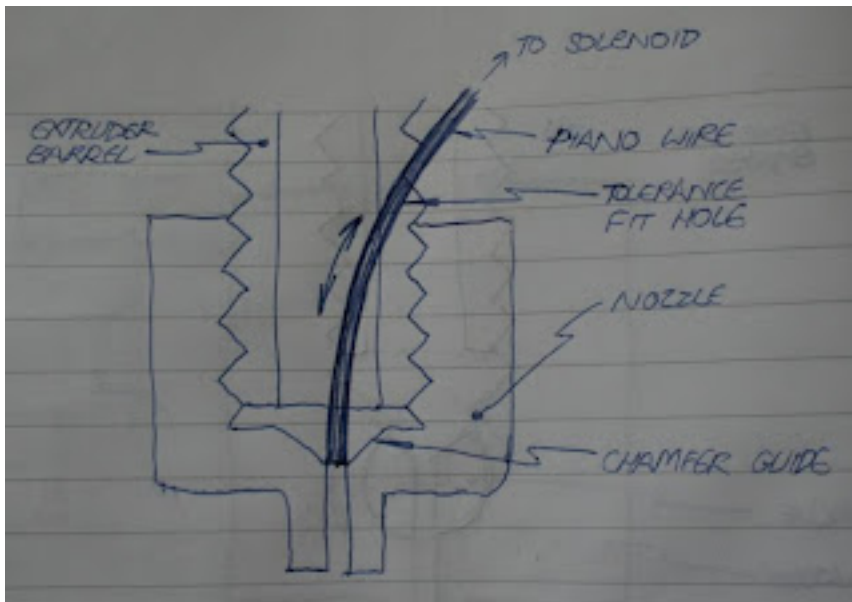

Much simpler to make than the first idea, and initial tests worked really well. No leakage. Developments to come...

Simple Hot Metal Valve

Tuesday, 15th April 2008 by Adrian Bowyer

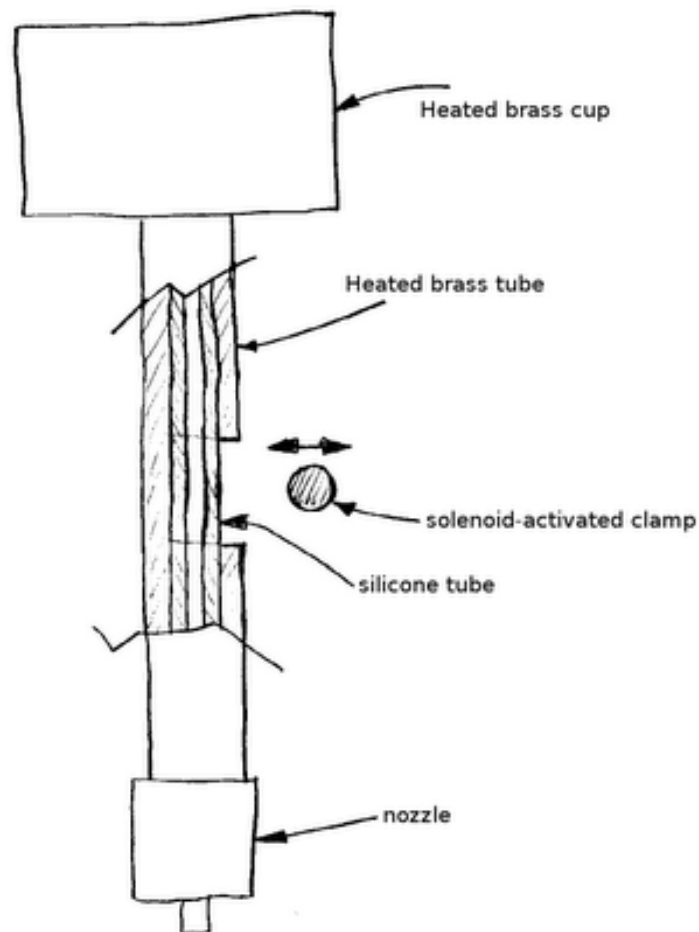

This is my prototype design for a field's metal extrude head. It uses the same brass tube that we use for the polymer extruder, and the same nozzle. The tube has a smaller silicone tube inside it and a notch filed in it. A solenoid clamps the silicone at the notch. There's a brass cup at the top full of field's metal (melting point 50 °C). All the brass parts are heated by wrapping them in nichrome wire set in JB Weld in our usual way.

And it works! Here's the vid:

[RepRap metal deposition head](#) from [Adrian Bowyer](#) on [Vimeo](#).

The heater (with no insulation) only needed a 50/50 PWM duty cycle at 12v to keep the metal molten, giving an average current about 600 mA.

Roll on electric circuits. Roll on electric circuits in full 3D...

RepRap prints a child

Friday, 18th April 2008 by eD



This is for anyone who doubts the z-axis. Ian's son, Johnny, weighs 17.5 kilos. Admittedly the axis will only drive Johnny down and not up, but that's the way RP goes anyway.

We did tests on other humans and found Darwin to have a lifting capacity of about 7kg. Perfect for babies.

Shaving The Yak

Friday, 18th April 2008 by Vik Olliver

Lots of things got in the way of other things this week. I broke a couple of corner brackets and my PC now runs out of memory before it can print a new one. I've dragged a beefy laptop into the workshop to try over the weekend.

As part of this, due to an amazing piece of [Yak Shaving](#), I have now committed the plywood RepRap files in SVG format to [Sourceforge](#). They're not complete, and there is no changelog. So obviously, that needs to be fixed for a start!

The original 4mm ply design is there, my 4.4mm attempts so far are there, and an MDF-based design that's not very Darwin-compatible is in the development stages. I haven't tried printing that last one out on [Ponoko](#) yet, and it's only half complete.

But I'd really like to get the parts I've made on the real RepRap together into a working machine, so for the moment I've released these files in their incomplete state for the enthusiastic among you to tinker with. Enjoy.

Vik :v)

PS The brass cup for the metal extruder looks like it might be easily made by tapping into the end of a 3/4" or 1" brass piping endcap and bolting the barrel on.

New Board: Arduino Breakout Shield v1.2

Sunday, 20th April 2008 by Zach Smith

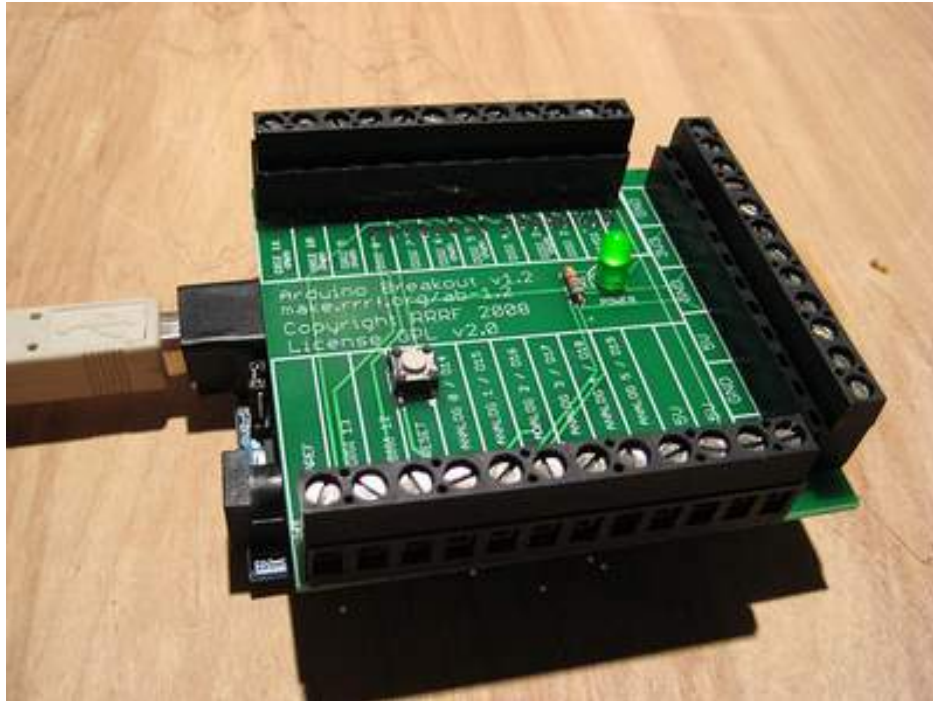

The Arduino Breakout Shield v1.2 is a really useful tool for Arduino based projects. It is a shield that plugs into the Arduino and transforms all the I/O pins into screw terminals. (plus lots of GND/3.3v/5V/input voltage pins!)

This is the latest incremental improvement, and the board feels pretty polished now. It has every I/O pin, a reset button, and a power indicator LED. Barring any sort of unforeseen bug, I'll be taking this one to production soon. Yay!

New Board: Temperature Sensor v1.1

Sunday, 20th April 2008 by Zach Smith

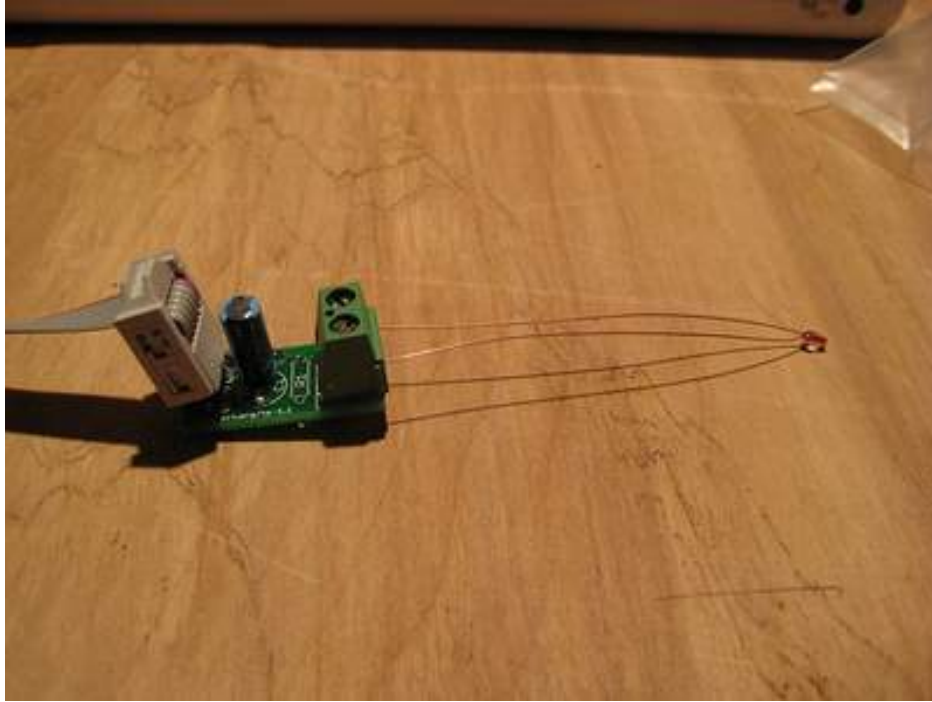

I just finished the documentation on the new Temperature Sensor v1.1 board. This board is an incremental upgrade over the previous temperature sensor board. It adds screw terminals for easier formatting and is now written for the default 100K thermistor.

More anti-ooze

Sunday, 20th April 2008 by Adrian Bowyer

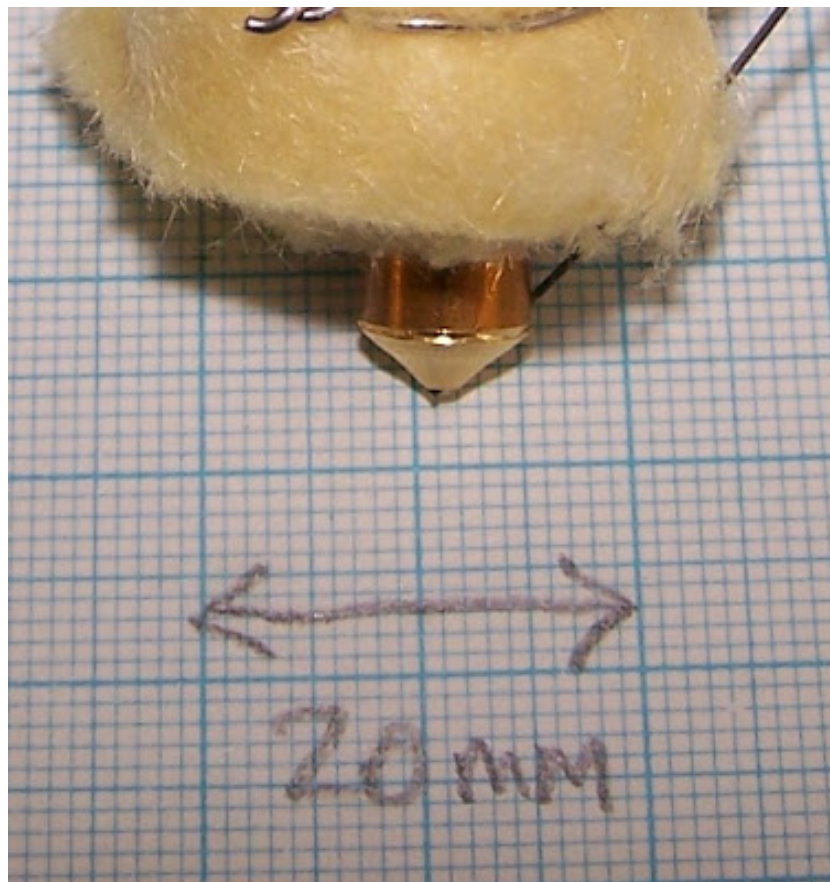

Inspired by Ed'n'Ian's blog below, I went home and made this. It is a nozzle with an 0.5mm sideways hole intersecting the 0.5mm nozzle hole. Into this goes a length of 0.5mm-diameter piano wire. When you shove it in by hand it stops the polymer flow instantly (even stalling the extruder motor if you leave that running). Pull it back 1mm and the flow restarts equally instantly.

It's really easy to make too:

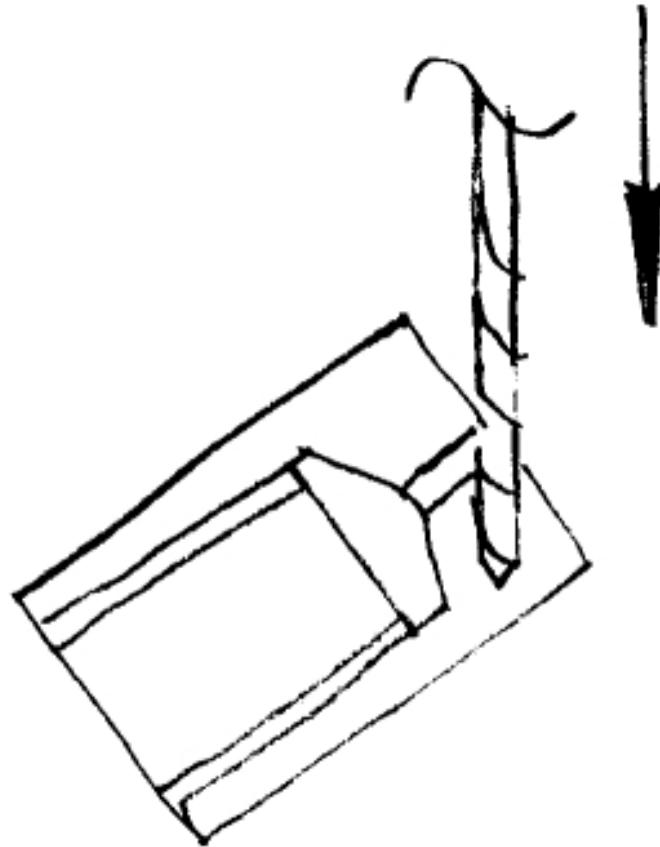

The trick is to drill the sideways hole using the nozzle hole as a centre before you make the cone. You have to use a woodpecker cycle to clear the swarf and be very gentle to avoid breaking the bit. But if you do, it works fine.

Then you just put the finished part in a drill chuck, use a felt tip to draw a circle round just below where the hole emerges, spin the drill and file the cone up to that circle.

Now to add a solenoid to move it back and forth automatically...

Darwin@Adrian goes Arduino

Wednesday, 23rd April 2008 by Adrian Bowyer

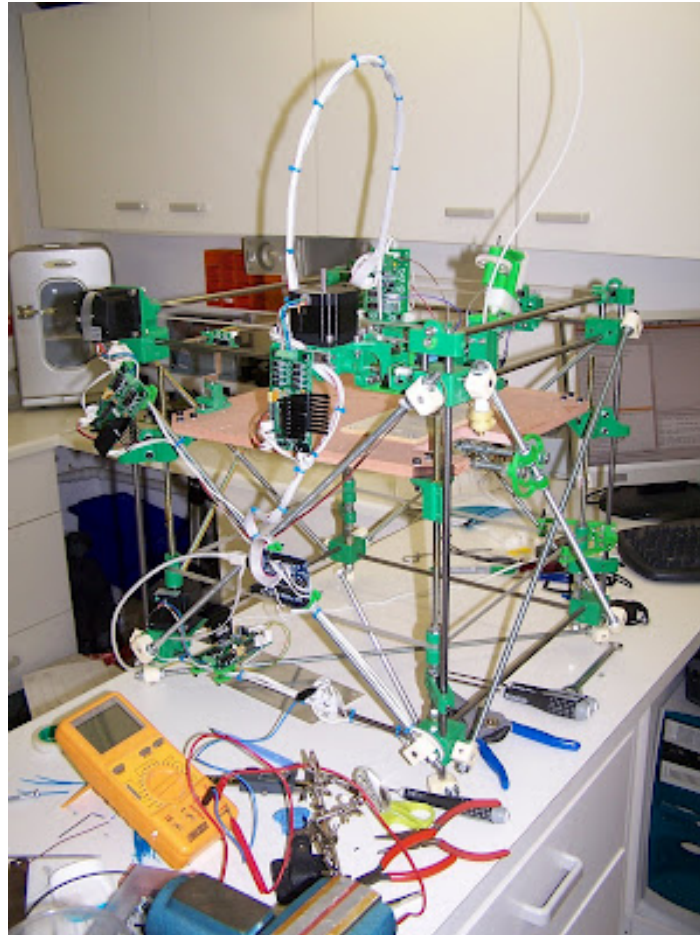

I've finished the hardware work on upgrading my home machine to Arduino control. I've done a few hacks:

1. I distributed the circuit boards round the machine next to the devices they control. This actually cuts down the wiring cross-section, if not number, in the sense that - for example - two power wires and three signal ones go to a stepper controller, as opposed to four power wires from it to the motor. Using ribbon cable for the signals keeps it neat.
2. I added 78L05 regs to the stepper boards so that everything only needs a single 12v supply. I just soldered them into the same holes as the power connectors, which I made 2-way screw connectors. There are already smoothing caps on the boards.
3. I reconnected the 5v input to the extruder motor controller board to its internal 78L05 to make a 5v output on it. This, and the ground connector next to it, are just at the right pitch to solder the little thermistor PCB on there facing backwards. It therefore gets a local 5v supply, and just needs a single signal wire to take the voltage from the potential divider to the Arduino analog input.

4. I don't have axis max optoswitches. If you leave them off, pin Analog 2 on the Arduino (Z max) needs to be grounded. X and Y seem happy open-circuit.

Everything checks out and seems to be working in the sense that I can drive the motors about. I think I still have to do a bit of debugging on the heater/temperature sensor...

Postscript: Number 3. proved to be a Bad Idea. The temperature sensing works a lot better if you drive the thermistor board off the Arduino's 5v line...

Made in China

Thursday, 24th April 2008 by Forrest Higgs

Last month, a little company that makes stepper motors in Shanghai posted a thread on the Reprap forums. Annie Fan from CW-Motor basically said that her company makes steppers and that they wanted to do business.

Of course, she got hammered for spamming.

I've lived in China and possibly have a better feel for how the small companies in China try to do business than most, so I emailed Annie and started a conversation. It turned out that they make NEMA 23's just like Darwin needs.

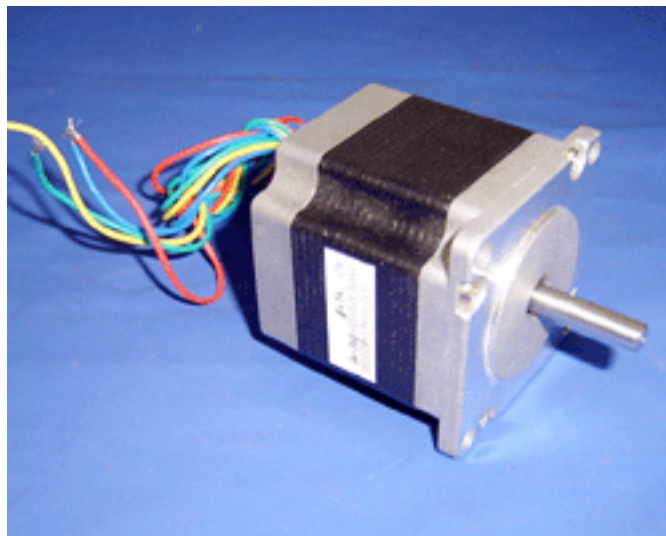

Now as I am sure you all know, I've not been overwhelmed with the Darwin design. The requirement for big, power hungry NEMA steppers has always seem to me to be excessive in the best of lights. I know, mind, that Darwin is a first design and that subsequent work will make much more efficient ones. I guess I just have a slight allergy to working with stepper controllers that pump multiple amps. I didn't scar but I did get a bunch of blisters when I got the diodes hooked up wrong on an L298N board I built last year.

All that aside, I started digging through CW-Motor's website and found a NEMA 23 that is causing me to have a serious rethink about Darwin and my objections to it.

Basically, their 57BYGH320 looks to be the answer to just about every objection I had to the Darwin design in terms of its power hunger. It's a 15v motor that delivers as much power at 12v as the original specification Nanotech that Adrian first used.

I ran the specification past Chris (nophead) since he seems to know loads about stepper motors

and he confirmed pretty much everything that I had read into the specification.

This bad boy only draws 0.4 amp at full power. It does that by using a LOT of very thin wire giving it a phase resistance of 38 ohms. What that means is that you could build a stepper controller board to drive this monster around the SN754410 chip that puts out 1 amp that Simon originally specified for Reprap years ago. No need for putting auto headlights in series with this thing to up the resistance or control amperage via firmware. You just wire it up and it should work fine as it is. No special arrangements and the controller for it could be put together and tested by a clumsy 12 year-old without your having to lay in a stock of burn creme and safety classes.

About the only shortfall of this stepper is that it is a 1.8 degree step angle instead of the 0.9 degrees that Darwin wants, so you would have to half-step with it.

Annie will sell this model to you for USD\$14.50/unit. I mentioned that it would be nice to have a 0.9 step angle and she said that they'd upgrade that model to 0.9 degrees for USD\$21.50, no problem.

Chris, unlike me, had the presence of mind to Google the model number and discovered that CW-Motor are apparently manufacturing these steppers for Kysan. You can see a fuller Kysan spec for this model [here](#).

Anyhow, Annie has turned my calculations for a Reprap design upside down. My little tin-can steppers, which also draw 0.4 amps at twelve volts deliver a small fraction of the torque that this Chinese stepper can deliver for the same amount of electricity. My big objections, electricity waste and high amperage circuitry have disappeared like morning dew on a warm day.

I've been over at Ian's BitsFromBytes looking at the costs of parts kits.

Anyhow guys, take a look at this stepper and see what you think. It could sure make Darwin a lot cheaper and safer to build and operate.

Just to assure you, I have no commercial or consulting connection with this firm.

Magnetic Rotary Encoder Design

Thursday, 24th April 2008 by Zach Smith

Magnetic Rotary Encoder

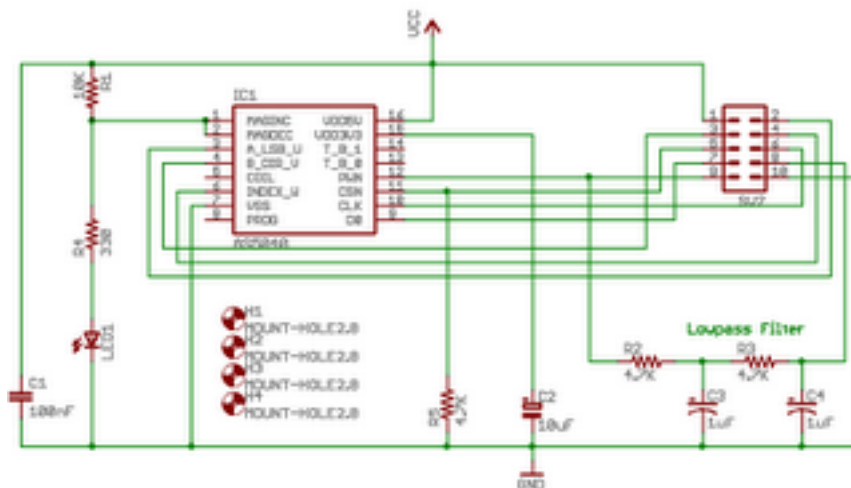

Hey RepRappers!

Inspired by Nopheads fantastic printing progress using his encoder, I decided that RepRap would greatly benefit by having an awesome, standardized rotary encoder board. The optical encoders can be finicky and hard to mount. Many RepRappers have also had great success in the past using AS50** family chips, so I decided to go that route.

I'm designing a new board around that AS5040 magnetic rotary encoder. Its nearly finished, I just need one more thing: Your input! This is one of the more advanced boards I've attempted, so if anyone has experience with the AS5040, or the Austria Microsystems magnetic rotary encoder chips in general, I'd love to hear you weight in.

Anyway, a few things to note:

- * the encoder has 10 bits of resolution (1024 steps/resolution!!!)
- * connector will be a 10-pin IDC header/connector to make life easy.
- * the AS5040 offers many modes, and I've attempted to allow you to interface all of them. The modes are: quadrature (+index), PWM signal, analog signal, and digital shift-register.
- * The pull-down resistor on CSN defaults it to quadrature mode

Thats about it. I've tested the quadrature wiring, and I'll be testing the rest this weekend. Assuming there are no bugs, I'll be laying out the board and sending it off for a prototype run next week.

Ball-chain update

Friday, 25th April 2008 by Vik Olliver

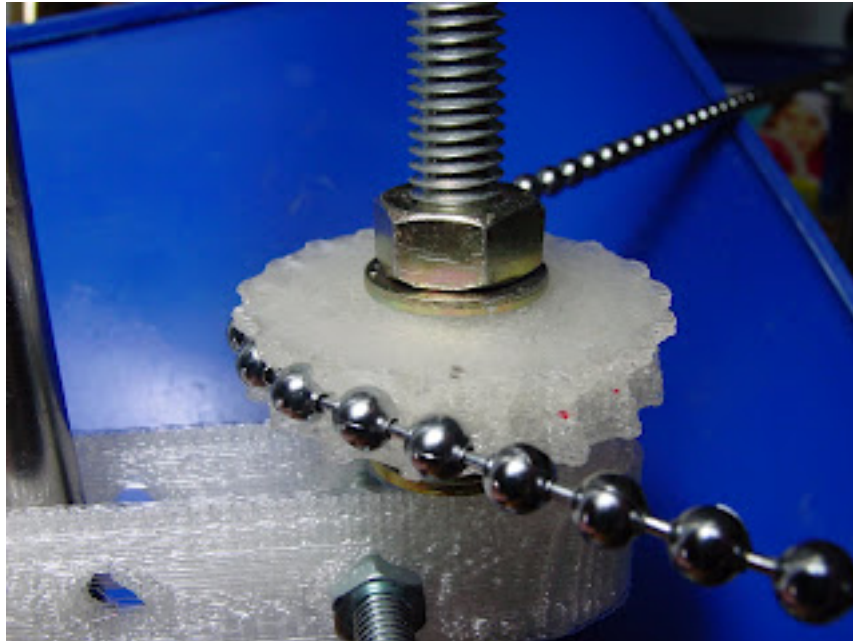

I've put a Z axis together using some ball-chain and 4 gears printed on my Darwin in PLA - I needed to fit a new motor anyway for testing with Arduino code. It appears that "4.5mm ball-chain" is a standard of some kind. It's a bit bigger than that normally used for keychains and biro bondage at the bank, but as I believe widely used by makers of window blinds and vents.

I have put the experimental ball-chain gear Aol files in the SVN on [Sourceforge](#). You may need to re-scale the rim using Aol depending on how thick a line your RepRap/RepStrap extrudes. With mine the chain fits well up to about 110 degrees around, then gets too tight. Fortunately I only need 90 degrees, so that's OK.

Turning the motor by hand makes the platform go smoothly up and down. Now to build some drivers for it.

Vik :v)

Gripping Stuff - The Extruder Clamp

Tuesday, 29th April 2008 by Vik Olliver

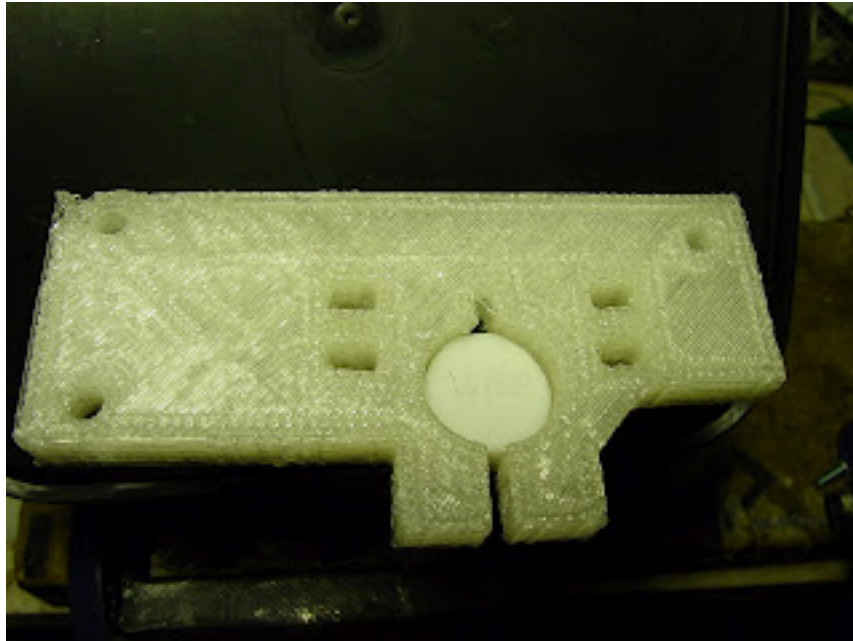

The extruder clamp was missing from my pile of parts in the "complete" RepRap, so I've remedied that. Took about 12 hours to print in PLA. As you can see, the clamp grabs a 16mm PTFE rod very well even without the clamping screws. There is also a channel in the clamp to take a 4mm self-tapping screw with which I intend to further secure the PTFE.

I was short a few diagonal bracing brackets, but those are no problem and shouldn't take more than a couple of days to run off.

I'm now also short an X-axis flag 'cos I put a bench vice down on top of it...

Vik :v)

Anti-ooze - the first design

Thursday, 1st May 2008 by Adrian Bowyer

Untitled from Adrian Bowyer on Vimeo.

Here is the new polymer valve in operation.

A solenoid pushes a short length of piano wire across the flow. This stops it instantly, giving a much better finish to constructed objects, and also stopping the polymer oozing from the nozzle when it is idle.

The AoI files for the design are in the subversion repository here. The solenoid I used is from RS: 250-0827.

I have also checked into the repository the changes to the host Java code and the firmware for the Arduino needed to drive the device. Note that, in the latter case, the new firmware disables the maximum (but not the minimum/zero) optoswitches on the RepRap machine's axes. Few people use these anyway, and - as pins on the Arduino are tight - it is better, I think, to use them to add new functionality.

Exactly the same code will drive the metal deposition head that I blogged here.

PLA & Stepper Drivers in NZ

Friday, 2nd May 2008 by Vik Olliver

I've got a 30kg test batch of PLA filament ordered up in New Zealand, which I'll distribute at cost. So if you'd like a 100m roll or two, shout up. I'll dispatch overseas, but do check the swingeing NZ Post overseas rates first. A roll is 420mm diameter and about 30mm thick, weighing approx 800g. If you want larger quantities, I'll put another order in for you no problemo.

Also, PMB Electronics of New Zealand now have the L298N and L297 stepper driver chips in stock at reasonable prices and low volumes. Tell 'em Vik sent ya. No, I'm not on commission. I've asked them to consider stocking Arduinos too, but mentioning it again wouldn't hurt :)

Vik :v)

Economics (n. pl.: the management of a household)

Saturday, 3rd May 2008 by Adrian Bowyer

Here's a reprapped coat-hook:



It took me 12 minutes to design in Art of Illusion, then I set it running in my home RepRap machine. The quality is a bit splodgy because, since I upgraded to the Arduino, I've been trying to maximize my build speed, and I have overcooked the outline printing rate a bit; I'll back it off for the next one.

Anyway. I went out for the afternoon, then I came back. Now I have a coat-hook that I didn't have before. Utterly trivial, except:

1. I have somewhere in my lab to hang my lab-coat, as opposed to draping it over my camera tripod:



and

2. An economist once told me that the world market for coat-hooks is bigger than the world market for gas turbines...

The design for the hook is [in the RepRap repository here.](#)

PLA Corner bracket failure mode

Saturday, 3rd May 2008 by Vik Olliver



Looks like we have a failure mode for PLA corner brackets. This picture shows a relatively recent bracket torn apart by the forces of fitting an 8mm rod into it and over-tightening one of the grub screws.

As you can see, the break is hardly a neat delamination, and the line of separation is at the apex of a teardrop-shaped hole. The corners also have little plastic in them, even after being squared off so they parted easily too.

As a temporary solution I am putting bolts through empty holes to hold things together. We'll see how it goes, but I think we may need to remove some of the unwanted honeycombing from the design and beef it up a little. I'm also installing the next one upside-down, so the apex of the teardrop is at the bottom of the bracket.

Vik :v)

Open sesame...

Tuesday, 6th May 2008 by Adrian Bowyer

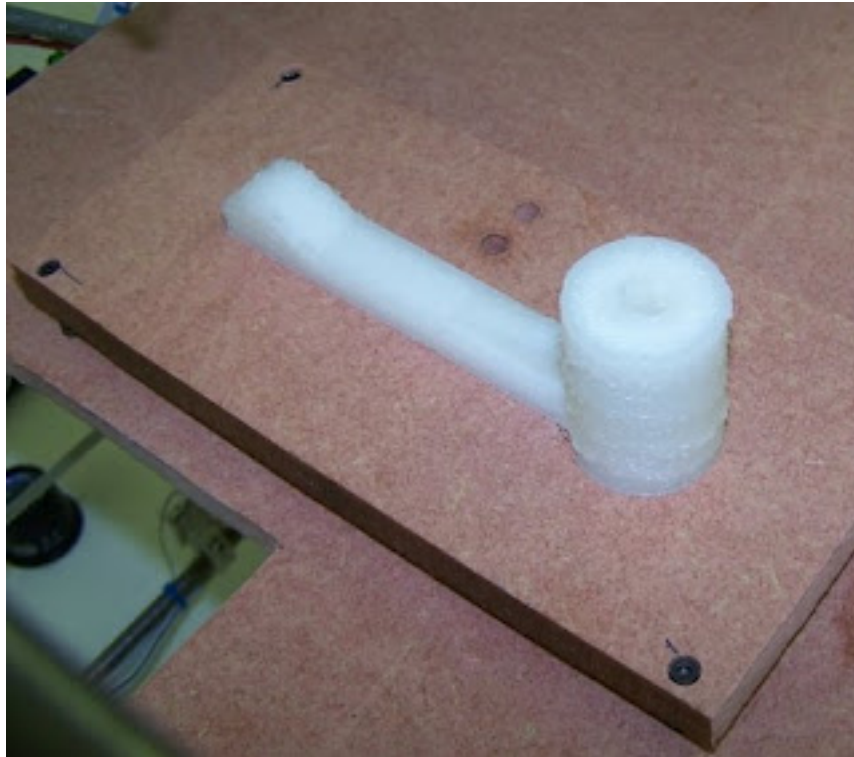

...using a rerapped door handle.

This was printed on top of the latest mod to my Darwin, which I recommend as it

1. Is simple to add, and
2. Saves lots of messing about with the Z-axis screw drives and zeroing.

It is a Z Bed. It consists of a piece of MDF held down by three (not four) screws and nuts. Between it and the bottom bed round each screw are some stiffish springs. With this, it becomes trivial to set up the $Z=0$ position so that it's exactly the same distance under the extrude head just by eye. You move the head about, adjusting the Z Bed's pitch and roll until it comes out right.

The trick, of course, is not to raise the Z Bed too high; then the head doesn't collide with it when you're moving the head about. Being cleverer than I, you should be able to manage that...

This is just a little test one. I shall replace it with a piece almost as big as the base below it. It'll have two screws in the front corners, and one in the middle at the back.

Oh. And now we can go out to the scullery:

Rerapped door handle from Adrian Bowyer on Vimeo.

(Well. We could before. But not using a cool rebrapped door handle...)

To get the door handle design, [see the RepRap objects library here.](#)

Bug fixing

Wednesday, 7th May 2008 by Adrian Bowyer

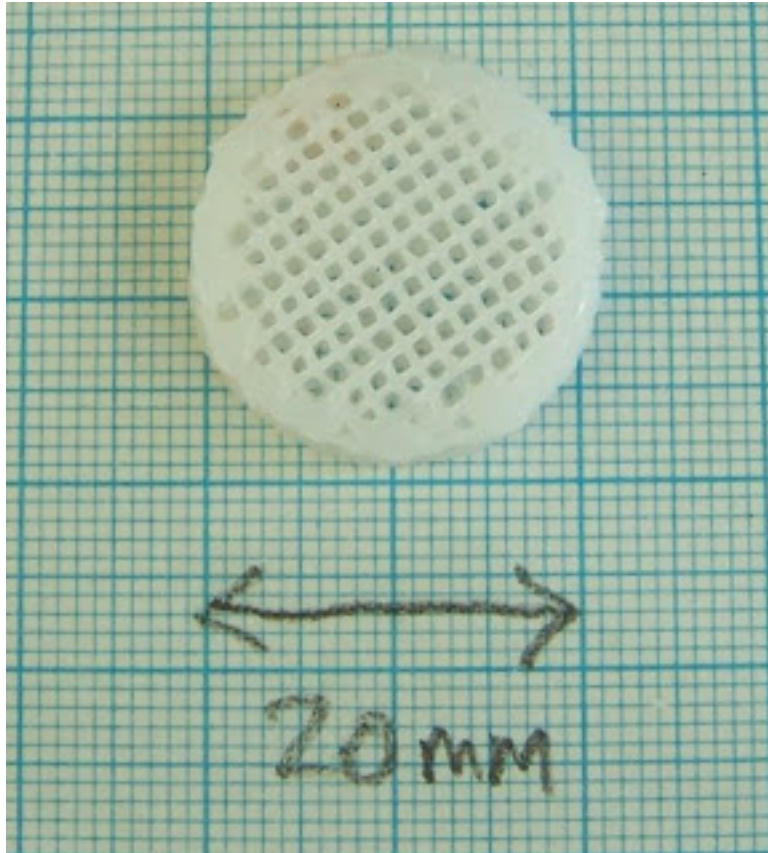

Inspired by some of Nophead's experiments, this is a water filter insert made in RepRap. Actually, it's a bit of a cheat: the model for it is a simple disc. But I've enhanced the host code so that you can plot multiple outlines of an object one inside another. Add that to the fact that you can set the infill width to whatever you like and the part becomes trivial to make. It took about 20 minutes in my home Darwin to build.

In general these enhancements mean that you can make the boundary of an object thicker (therefore stronger) and do a sparse infill, thus both saving material and reducing build time overall.

If you set

```
Extruder0_NumberOfShells(0..N)=1
```

in the properties file you get a single outline as normal. Setting it to bigger integers gives that number, one inside another. Setting it to 0 suppresses outline plotting altogether.

Also, if you set

Extruder0_ExtrusionInfillWidth(mm)

negative that suppresses infill hatching.

Anyway. Here it is filtering some non-potable water as input. (Mark you, I wouldn't drink the output, either...)

RepRap water filter from Adrian Bowyer on Vimeo.

Despite all evidence to the contrary, the noise on the soundtrack is not a Sopwith Camel that has just received the *coup de grace* from the Red Barron. It is my neighbour's lawnmower. I'm glad to say that he has removed the Lewis gun...

Freduino is free.

Sunday, 11th May 2008 by Zach Smith



I recently acquired and built a Freduino kit from nkcelectronics. The freduino board is a clone of the Arduino and is 100% compatible, right down to the pin placements. It was a painless build, and the board worked right away. If you want to have a machine where you've built all the boards yourself, or you want to save \$10 and buy a kit, this board is for you. Or, if you just want a board that is as free as free can get.

From the Freduino website :

Freduino is a collaborative open-source project to replicate and publish Arduino-compatible hardware files. The Freduino Eagle SCH, BRD and Gerber production files allow users to create boards that are 100% functionally, electrically and physically compatible with Arduino hardware.

Inter-layer cooling?

Thursday, 15th May 2008 by eD

Inter-layer cooling

Now Adrain's got the polymer extruder valve tuned, we've got loads more control over the extrudate. Which begs the question, why nozzle wipe? From experience this procedure ups the risk of what we affectionally call "nozzle crap" - unwanted bits of filament getting attached to the nozzle. So now there's the option to skip that and move straight to the next layer. The only side effect is cooling is eliminated, which *might* be a problem for small parts, we shall see...

Progress with ABS

Monday, 19th May 2008 by nophead

I have developed peelable rafts and a reusable bed for ABS: -

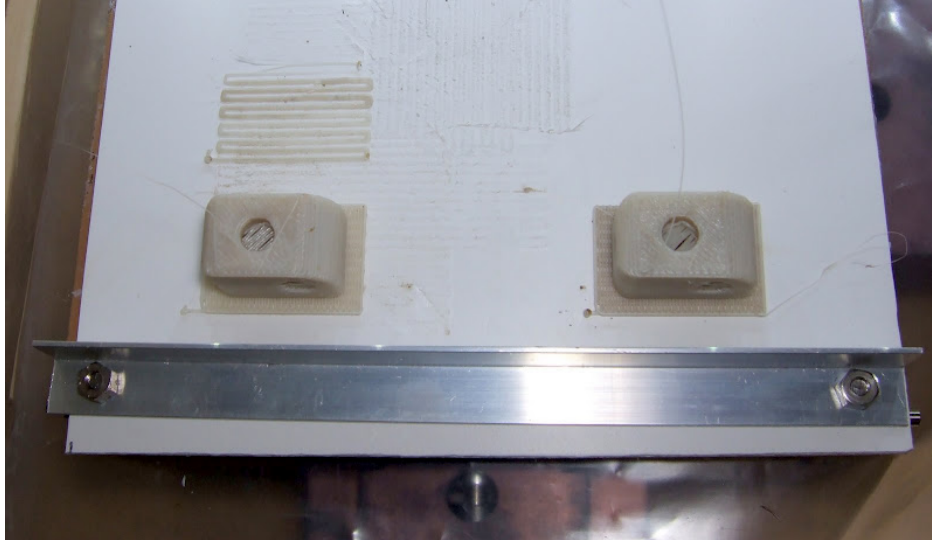

That has enabled me to make these Darwin parts before my extruder broke again: -

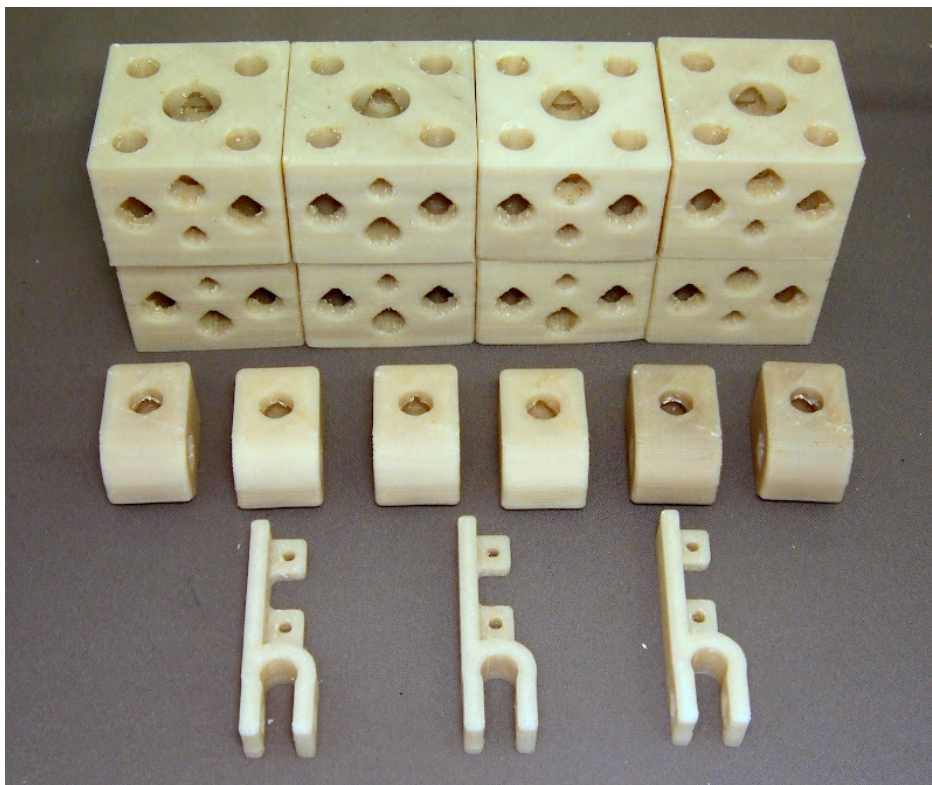

Details here: hydraraptor.blogspot.com/2008/05/stepping-up-production.

Shoe

Tuesday, 20th May 2008 by Adrian Bowyer



I lost count of how much I spent on shoes when my daughter was growing up.

I just rewrapped a left shoe. It cost me 30 pence...

And, should your child be as financially inconsiderate as mine, and also grow, a quick click on the

scale transform in Art of Illusion solves that problem. And scaling by -1 in any single dimension turns left into right...

Here are the parts as they came off my RepRap machine; I used PCL:

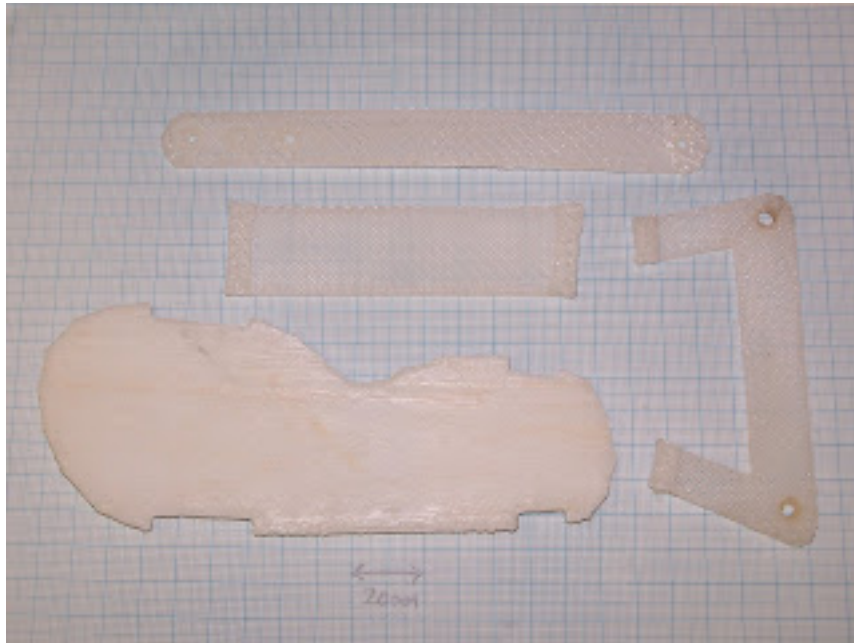

I simply welded them together using a coffee cup full of hot water to melt the edges a bit. I'll post the design in the repository shortly when I've made a few final tweaks.

Now for the right foot...

ABS Door handle

Thursday, 22nd May 2008 by nophead

Adrian asked me to try his door handle design in ABS. Here is how it turned out: -

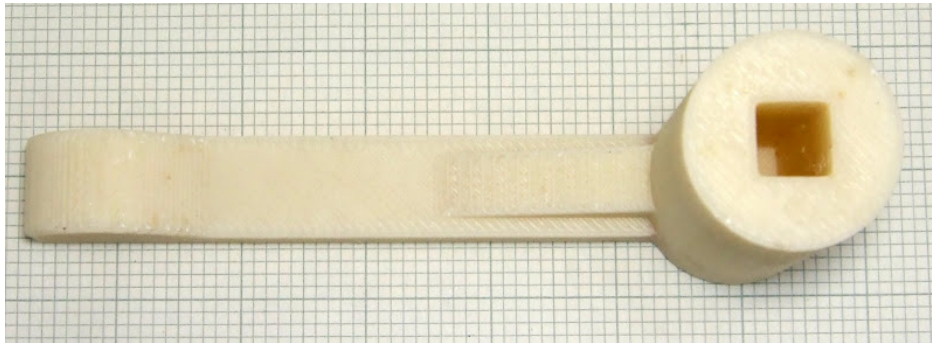
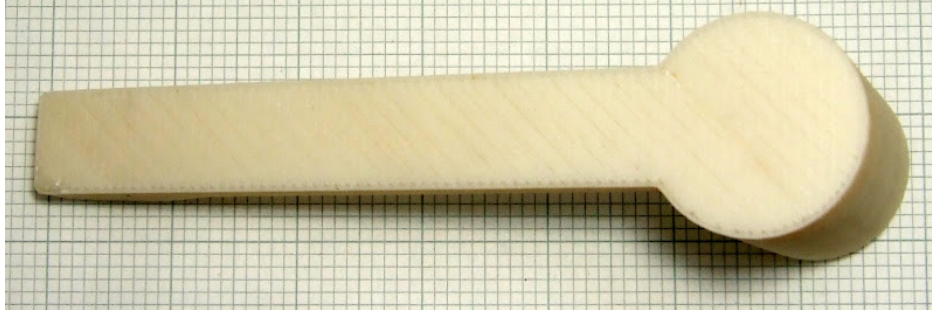

It took 2 hours to make (not including the raft) with a 25% fill. It seems like it would be plenty strong enough.

I added a 4.2mm hole for tapping for an M5 grub screw. I didn't teardrop it because below a certain size that is not necessary. It came out slightly under 4mm so I ran a 4.2mm drill through it and then tapped it M5.

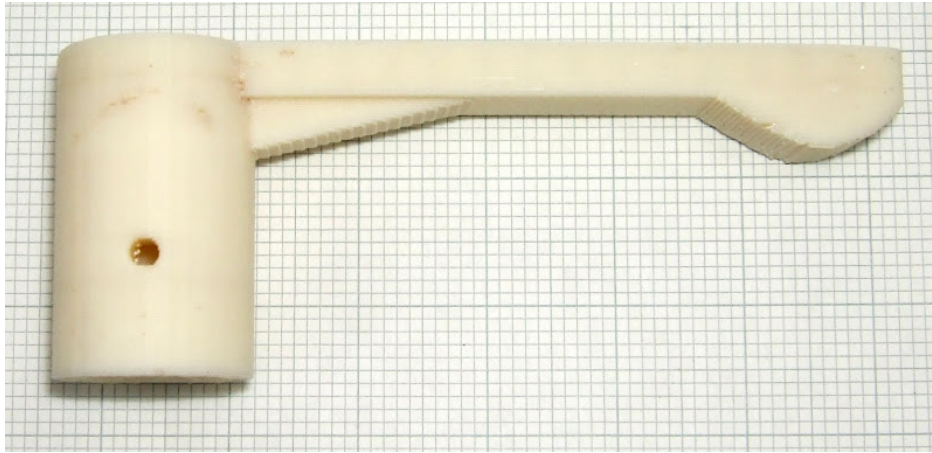

Here it is with the screw fitted: -

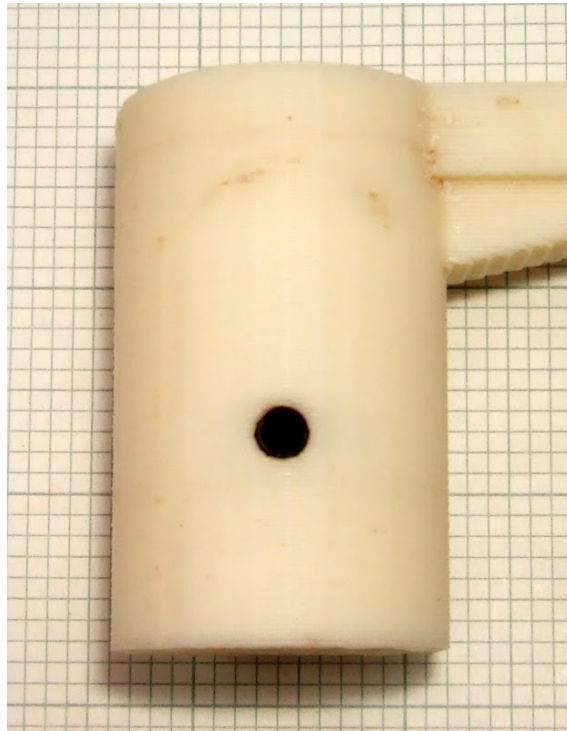

ABS is a bit soft for tapping, so I think a captive nut would be a better design. We don't have any compatible doors so I did not try it out.

I think it came out very well, but being a perfectionist, here are a list of the defects: -

- The faceting on the cylinder is noticeable because it seems to be made of only 32 segments. I think this is just a setting in ArtOfIllusion rather than being due to simplifying the mesh to 0.1mm resolution. AOI is intended for rendering, where surface shading normally interpolates the normals to get a smooth effect. In real life you need a few more line segments.
- There is scarring where I removed the strings with a knife. The anti-ooze mod should solve that.
- There is some brown discoloration, which is also indirectly due to ooze. When the extruder ends

a filament run it turns off, lifts slightly and moves quickly to the start of the next run. Sometimes that leaves a string, sometimes it snaps and leaves a peak of filament sticking up. That rubs against the nozzle and picks up burnt plastic from it. Hopefully the anti-ooze valve will fix that as well.

- The start of the first filament came unstuck. That is because I do the first layer at a low temperature to allow it to peel from the raft. I raise the temperature for subsequent layers but I don't wait for it to heat up before I start the second layer because of the ooze problem. I stuck it down with a bit of super glue.
- It is slightly warped along the length, but it does not matter in this design. I am hoping post heating in an oven before removing from the bed will reduce that significantly. Using PLA would also reduce it.

So I am pinning my hopes on anti ooze being the cure of all ills!

Then there were two...

Thursday, 22nd May 2008 by Adrian Bowyer



TRADITIONAL flyswatter :-)

Friday, 23rd May 2008 by Adrian Bowyer

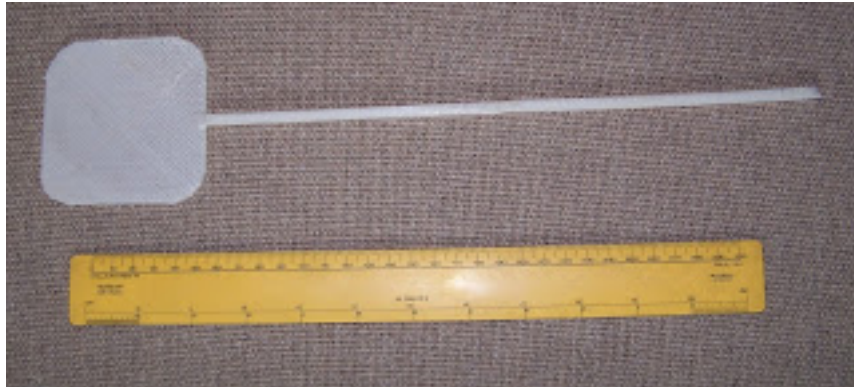

Ha! None of this laser nonsense... Here's a *traditional* flyswatter that I made last night. Like Vik, I'll put this in the repository as soon as I can. I *shall* be No 1 in the flyswatter download chart...

Laser-Sighted Flyswatter

Friday, 23rd May 2008 by Vik Olliver



In the never-ending battle between man and fly, the flies have the edge in manoeuvrability and speed. What you need is a system that takes them down first time, every time. The Flyblaster 3000 (not TM, no patent pending) brings you that capability by combining the latest in laser technology with the most effective non-chemical anti-fly system available.

Simply use this reapped fixture to clamp a cheap 12mm diameter laser pointer onto a spring-loaded flyswatter with an M3 bolt and watch your winged insect problems fly out of the window.

Design of a RepRappable spring-loaded flyswatter is left to the diligent student.

Full diagrams for the clamp will be available when I can edit the Items Made page :)

Vik :v)

Quality development

Tuesday, 27th May 2008 by eD

I saw these door handles on the bench today from Adrian and Nophead and thought 'photo'. From left to right: old to new. Its exciting to think about where this trend leads!

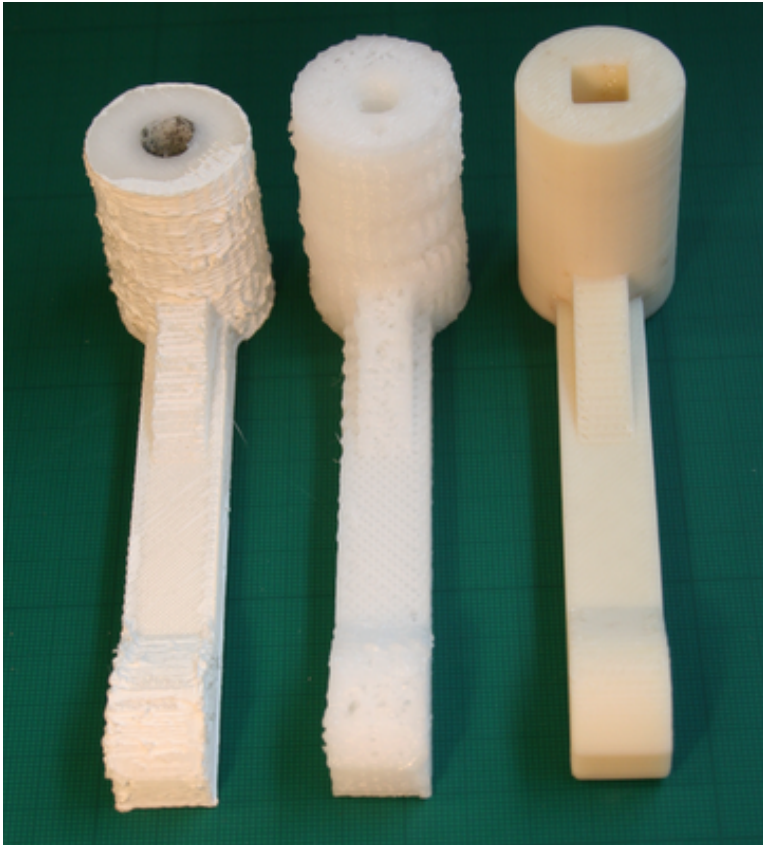

Arduino Firmware v1.3 Released

Tuesday, 27th May 2008 by Zach Smith

Changes:

SNAP:

- * overhauled stepper motor timer interrupt routines
- * updated stepper speed to completely emulate PICs
- * added thermistor table support
- * added support for extruder valves

GCode:

- * moved to init file for configuration
- * overhauled message receiving system
- * add stepper disable safety check
- * overhauled and improved gcode string parsing
- * added support for G2/G3 arc codes
- * added support for averaging temp readings
- * added support for thermocouples
- * initialization process is much better
- * removed need for external libraries
- * added experimental support for an extruder encoder

[Download it from SourceForge](#)

Come and see RepRap!

Saturday, 31st May 2008 by Adrian Bowyer

Come and see RepRap
at the Science Centre
on Saturday 31st May
from 10am to 4pm
in the main hall.
It's a free event
and you can see
the RepRap machine
in action. It's
a really interesting
technology and
it's worth seeing
it in person.
Come along in
the evening.

ABS coat hook

Sunday, 1st June 2008 by nophead

I made Adrian's coat hook in ABS for an exhibit at Cheltenham. The only problem is that my machine broke and it took me a week to get it working again. See hydraraptor.blogspot.com/2008/06/catalogue-of-disasters



This was designed by Adrian, sliced by Enrique's software, extruded though a nozzle made by Adrian. It took about 40 minutes and used about 8g of ABS costing \$0.16.

RepRap achieves replication!

Tuesday, 3rd June 2008 by Adrian Bowyer

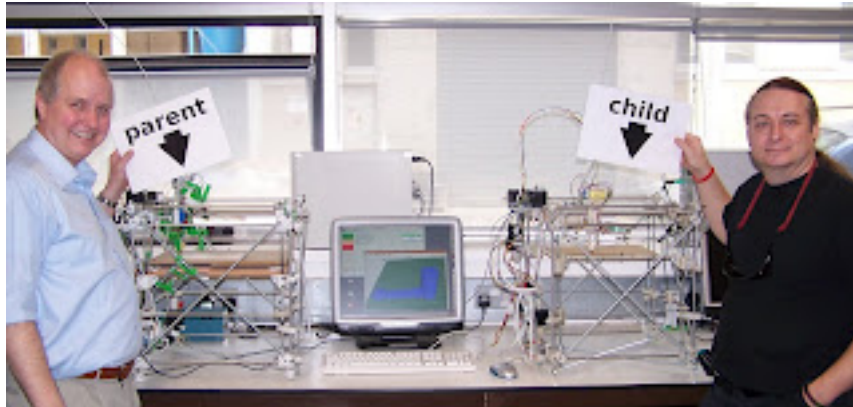

Adrian (left) and Vik (right) with a parent RepRap machine, made on a conventional rapid prototyper, and the first complete working child RepRap machine, made by the RepRap on the left. The child machine made its first successful grandchild part at 14:00 hours UTC on 29 May 2008 at Bath University in the UK, a few minutes after it was assembled.

[Sorry this news is a few days late, RepRap fans. We had a press embargo on it till 4 June to coincide with the opening of the Cheltenham Festival (see above and below), and it wouldn't be very good practice to break our own embargo :-)]

Full Electronics Kit Now Available

Thursday, 5th June 2008 by Zach Smith



Image not found.

Not only has RepRap achieved a major milestone, but the not-for-profit RepRap Research Foundation has also reached a major milestone: we are now offering a complete kit that contains all the electronics you need to build your own RepRap machine. We've come a long way since starting the Foundation in in May 2007 and have managed to create a business that is useful and awesome.

Looking forward, now that we have achieved replication, 2008 is going to be focused on moving the RepRap technology out of the lab and into production. Our goal is to have printed RepRap parts available for purchase by the Christmas 2008. Soon, anyone who wants access to a cheap, open source, awesome, self-replicating 3D printer will have it!

RepRap at the Cheltenham Science Fest

Monday, 9th June 2008 by Adrian Bowyer



Here is the RepRap stand at the Cheltenham Science Festival, with Nophead, Ian, Vik and Adrian (taking the picture) running out of vocal chords explaining what it's all about. Ed gets an honourable mention for helping to set up, and for manning the stand on the last day. In between he was slightly indisposed owing to his having taken a drink from a stream while on a hike without dropping in a little pill first...

We had both the parent machine (on the left) and the child machine made by the parent (behind Vik) working side by side, the first time this has been done in public.

We were the talk of the show - we lost count of the people who came up saying, "My friend said I'd got to see this," and, "We saw you on TV/in New Scientist and had to come to look." Also we were the stand that all the other staff on the other stands wanted to see.

And finally. Here's a video of a vacuum pump that we designed and built at the exhibition using the RepRap Child machine.

Vik's Venturi Vacuum from Adrian Bowyer on Vimeo.

A big thanks to all reappers everywhere for making it all so possible so quickly.

Adrian & Vik

Sensing temperature with no temperature sensor

Tuesday, 10th June 2008 by Adrian Bowyer

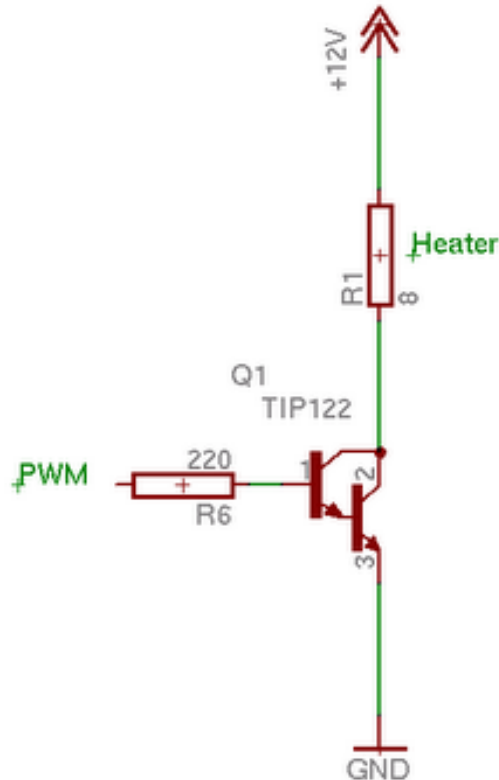

As always, apologies to whoever first suggested this causing it to sink into my unconscious and then re-emerge months later as my own idea...

Above is how we drive the heater in the polymer extruder. The microcontroller feeds a PWM signal into the darlington, and that puts a biggish current through the heating coil - typically about 1.5 A.

Ages ago Vik suggested using the change in the resistance of the heating coil to measure its own temperature by passing the current through a sensing resistor. But there are two problems with this:

1. That sensing resistor would get hot too, and so not give a stable indication of the current, and
2. The sensing resistor would waste some of the power.

Here's a way round that:

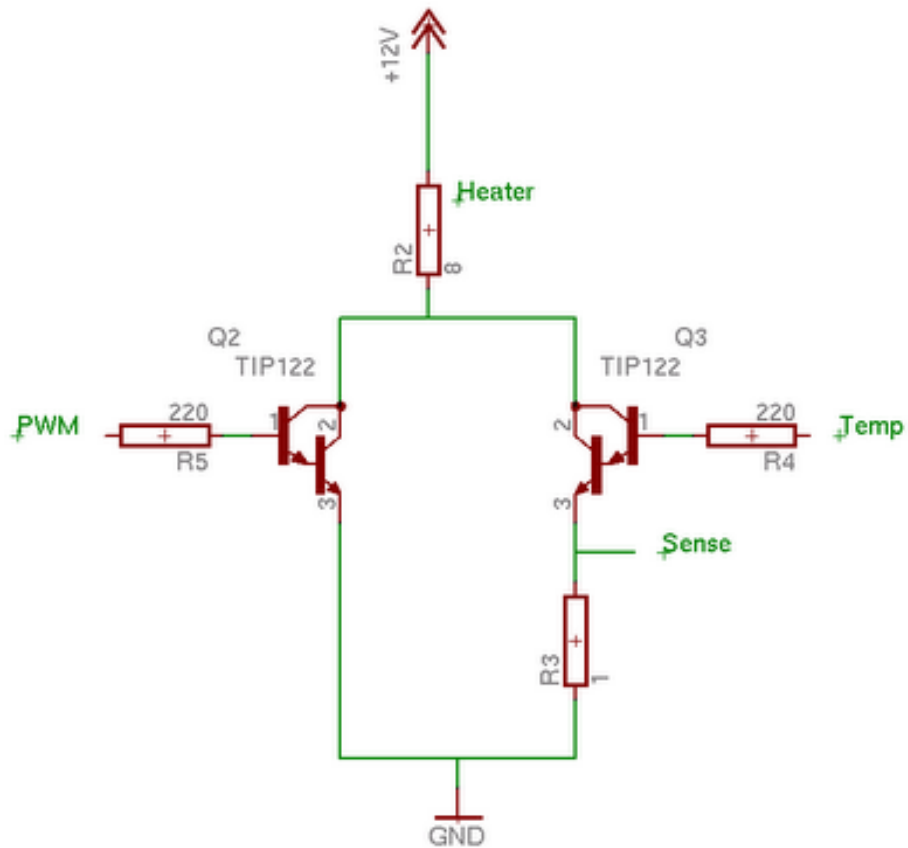

You leave the PWM/darlington circuit exactly as it is. But you add a parallel darlington and sense resistor too. Then, every second or so, *in the middle of the period when the PWM signal is at ground*, you turn on the other darlington at "Temp" for a few microseconds and measure the voltage at "Sense". That way the sensing resistor doesn't have time to get hot, and you don't waste power through it in normal operation.

I've put the value of R3 as 1, but one wants to choose a value that will give about 3V at "Sense" when the heater is cold - probably about 3R3 - because the microcontroller A->D has a full range of 5V. The "Sense" voltage will drop as the heater gets hot and its resistance increases.

Intermediate Java release

Friday, 13th June 2008 by Adrian Bowyer

A couple of weeks ago I released RepRap host 0.9. This was an intermediate release as some people wanted some of the new functionality that we're building into the system. That is mainly a single control panel to allow you to move the RepRap machine about, run the extruders, and so on. This works, but it is not yet finished.

Sorry for the lateness of this post; things got a bit buried under the attention for our hitting our first replication...

PIC file release

Friday, 13th June 2008 by Adrian Bowyer

I've just done release v1.2 of the PIC firmware. Get it [here](#).

There are three files in this release:

reprap-firmware-fullstep-all-20080613.zip

reprap-firmware-halfstep-all-20080613.zip

reprap-firmware-halfstepXY-fullstepZ-20080613.zip

These do as they say - you can either half-step or full-step the motors. Half stepping is more precise, but slower; full the opposite. There is a problem with integer overflow for tall objects (> ~50mm) if you half-step the Z motors. The third file allows precise XY, and also allows Z to go to about 100 mm. Precision is not needed for Z as it uses a screw drive anyway.

This version of the firmware will drive a solenoid valve in addition to the heater, extruder motor and cooling fan.

THE FAN NOW WORKS OFF RB6, not the spare channel of the L298. That channel is used to drive the solenoid.

To drive the fan, wire in a TIP110 to ALT 2 (or ALT 1), connect in the end of the 220 ohm resistor that goes to the base of that transistor, but connect the other end to hole 4 on the 7-hole connector by the Max/Empty connector. This goes to RB6. It's probably a good idea to wire a diode across connector P7 so that it's reverse biased (stripe to the +12v line, in other words); that'll take care of any back EMF from the fan motor.

The code is now compatible with the Arduino, and the latest Java host software is set up to drive it too.

As we are now switching to the Arduino, this is probably the last PIC file release that we will do.

Unsupported!

Saturday, 14th June 2008 by nophead

It is surprising what can be built without support material. Kyle Corbitt has designed a RepRapable solar collector described [here](#).

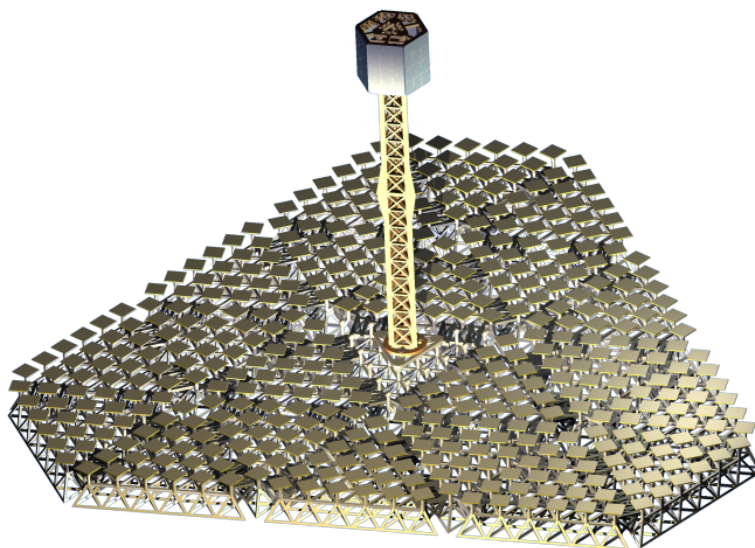

The structure is made up from a triangular lattice like this : -

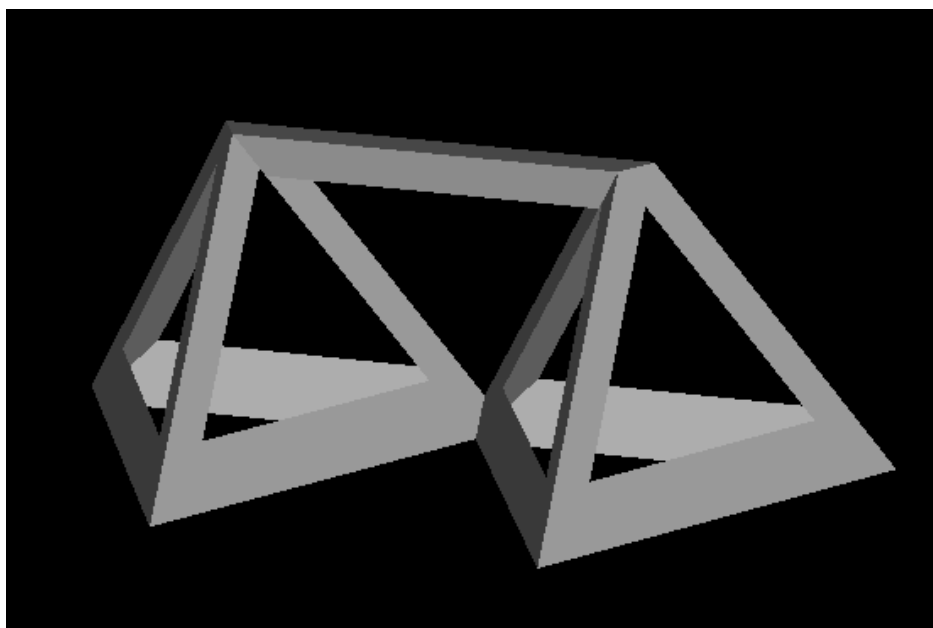

The risers only overhang 30°C, so they are no problem but the horizontal beam looks like it should need support material. Kyle asked me to try building it without, so I gave it a go. Here is what it looked like after it was made: -

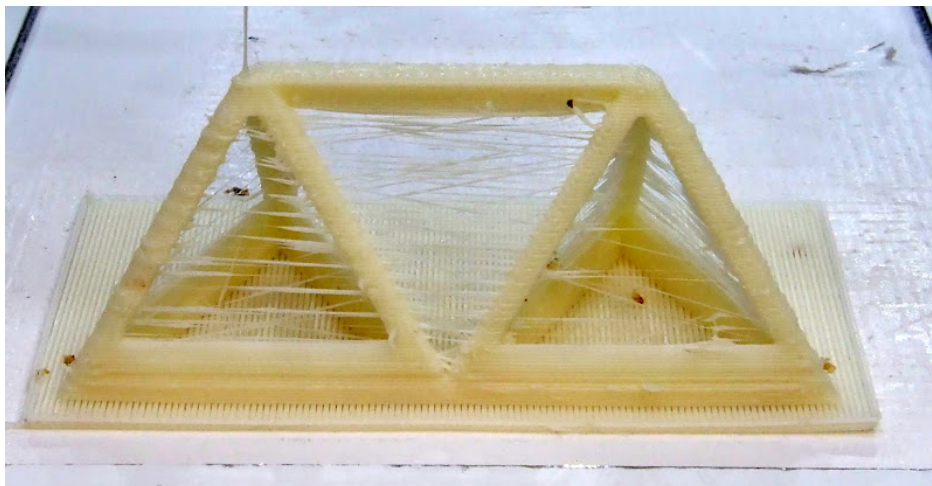

Very hairy but basically sound. This is it after being cleaned up with a scalpel: -

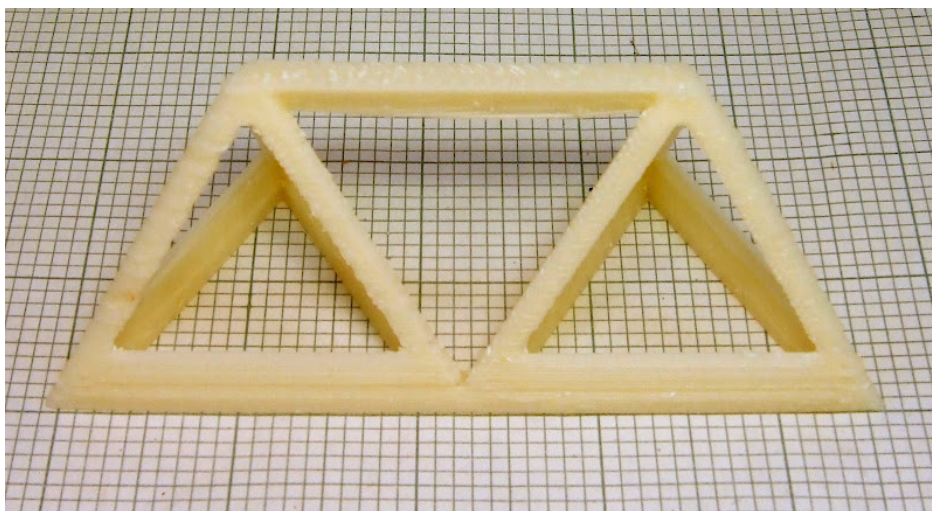

It took about 45 minutes to make and used only 7g of ABS, not including the raft. Head travel while not extruding was about 42% of the filament length but as I move twice as fast as I extrude that was only 21% of the time.

Despite the risers only being about 3.7mm thick it is very strong and rigid. I loaded the centre of the beam to 1.5Kg and it showed no sign of breaking. I also loaded one end to 6Kg with no sign of movement, so the beam could easily support 10Kg and possibly a lot more.

At the top of the base beams the triangular section goes down to zero width. The top four layers

are only one filament wide so are very fragile. I don't think they add much to the strength so it would be better to truncate the top of the triangle. Interesting though because it is the first time I tried to make something this thin (0.6mm) in ABS.

Enrique added an option to make the infill go along the length of bridges but it is not actually needed for this shape. The top beam has an inverted triangular section so the first layer of it is just two parallel outlines which span the gap. The rest of the beam builds out from this at 30° so it does not matter which way the infill goes. The first few layers did sag a bit but the top of the beam is flat. An inter layer pause may have reduced the sagging.

So this looks like a good way to make large structures that are light and quick to build, but still strong.

Another example of getting away without support [here](#).

Line buffering in the Arduino

Wednesday, 18th June 2008 by Adrian Bowyer

Arduino line buffering from Adrian Bowyer on Vimeo.

I have implemented a poly-line buffer in the Arduino code. This means that, when the host software wants to plot a polygon, it doesn't have to wait till one line segment is finished before sending the next. It can just blast them at the Arduino as fast as it likes (it gets stopped when the buffer is full...) and, more importantly, the Arduino always has a line ready to plot so there is no dwell between one line and the next.

The video shows it working. As you can see, the movements are much smoother with fewer and shorter pauses (unless your broadband is a bit narrow, when any jerkiness will be download delays...).

There are still some tweaks that need to be made to the host Java software (this upgrade has very temporarily killed temperature polling, for example...). We'll do that over the next few days.

Meanwhile, if you want to experiment, the host software is [here](#), and the Arduino code is [here](#).

For it to work you have to set the properties variable `Extruder0_PauseBetweenSegments` to false.

New Board: Opto Isolator v1.0

Friday, 20th June 2008 by Zach Smith

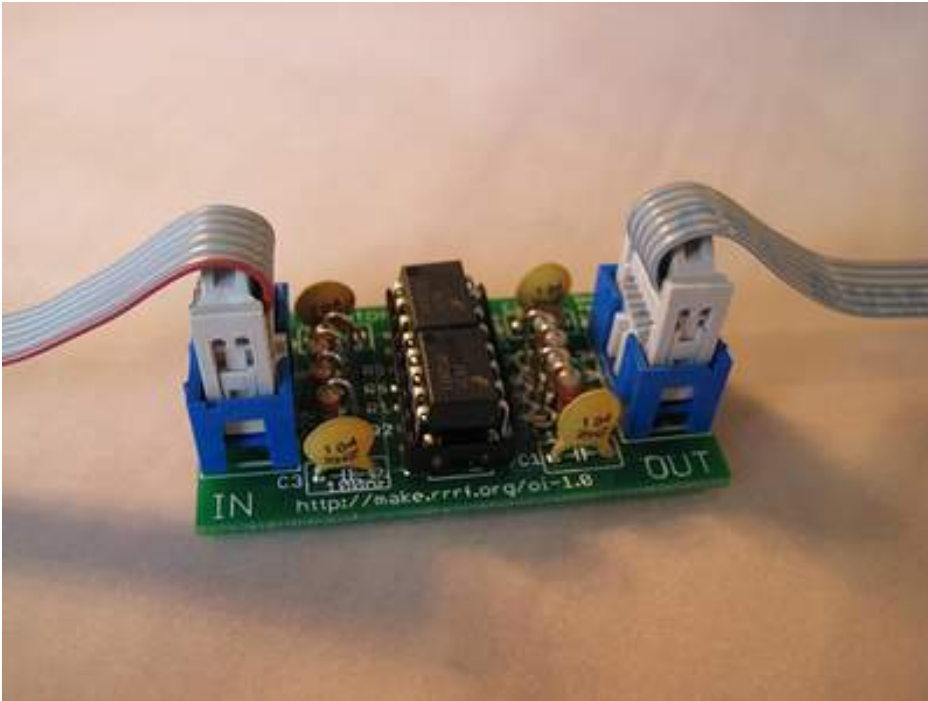

I'm proud to announce a new board today, the Opto Isolator v1.0. The opto isolator board is an accessory board that will make your electronics safer, contain less noise, and more reliable. An opto isolator is something that isolates 2 circuits electronically, while allowing you to pass signals through. It can protect against power spikes, as well as preventing noise (say from a motor) from passing through to your Arduino. The circuit itself is based on 2 of the HCPL2631 chips providing a 4-channel opto isolator capable of up 2.5kv of isolation, and 10Mbit/sec data transmission. Plus, its a beautiful and symmetric board, not to mention our first RepRap board to use super-awesome IDC headers. Yay!

Check out the full-on documentation today, or pick up a kit from the RRRF.

Measuring extruder temperature using Adrian's circuit

Wednesday, 25th June 2008 by Forrest Higgs

I prototyped and tested [Adrian's proposed circuit](#) for using the resistance of the Nichrome 60 heater on Tommelise's extruder barrel to measure its temperature...

Quitesome time ago, Vik Olivier suggested that it should be possible to use the resistance of a Nichrome heater wire to also measure the temperature of what it was heating if one were clever enough. A few days ago, Adrian Bowyer published a circuit design that could make that possible. I intended last weekend to do a lashup of the circuit to see if it would be of use in my next generation extruder design for Tommelise 2.0. Because of some other firmware issues that took longer than I expected I didn't get around to cobbling the circuit together till yesterday. It seems to work quite nicely.

A little background, first. While, I've been quite addicted to the notion of a single control board design for literally years now, I recently decided for convenience to have a main controller board run the positioning system and another, smaller board run the extruder(s). The reason for that change was more practical than philosophical. I knew very well what was needed to run the positioning system. The extruder, thanks to the growing number of people making and using Darwins with their Mk II extruder, had entered a period of rapid evolution. What with dribble controls, encoding the pump shaft rotation and now this nice new proposal for measuring extruder temperature, it seemed to me that it would be good to just freeze the main control board design and put another microprocessor to work just looking after the extruder(s). In my design the two boards would talk to each other via a I2C link, a technology that I've recently had a lot of experience with in setting up my EEPROM buffer.

To that end I put an add-on board to handle Adrian's circuit onto my old 18F4550 prototype board. You can see the lashup here.

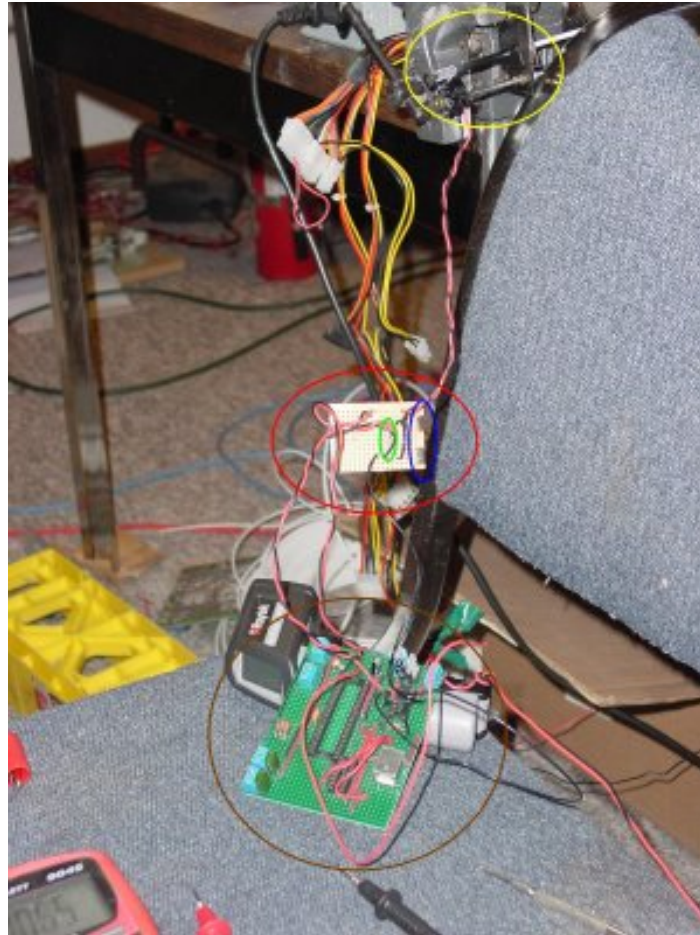

The yellow circle at the top of the pic encloses the actual barrelextruder barrel. The red circle in the middle marks the add-on board and the brown circle at the bottom encloses the 18F4550 prototype board.

Looking more closely at the add-on board (yellow circle) I've marked the two transistors that are TIP 122's in Adrian's design and BD681's in mine. The green circle right beside them encloses a relatively highwattage 1.6 ohm resistor a handful of which I bought to build up Zach's stepper controlled board and then never did. I couldn't understand why Adrian put the 220 ohm resistors between the transistors and the microcontroller, so I left them out. Mind, I expect that there is some very good reason and I'll find myself putting them back in at some point. Mostly, I didn't have any 200 ohm resistors in my supply drawers, so, since I hadn't used any such thing heretofore I omitted that part of his design. The Tommelise extruder heater is rated at 6 ohms. Figuring a nominal voltage to the heater of 12v that means that I should read about 3.3v at the sense point when the system is cold. Resistance for Nichrome 60 at 250C is about 1.15 times its resistance at ambient. What that means is that the voltage measured should drop about 0.34v over a range of about 230C. Given that the 18F4550 has a 0-5V range, 10 bit A/D circuit on-board what you are looking at is about 3.3C resolution for this kind of temperature measurement.

While I've not had time to design the firmware I did a cursory test of the circuit manually by tapping the extruder heater with a 5v supply source and then quickly measuring the voltage on the other side of the circuit with a digital meter after I'd disconnected the power input. The voltages are moving in the directions that Adrian suggested, so I suspect that my circuit is, more or less, right.

I fiddled with a range of resistor values for the 2.6 ohm one that I was using and discovered that while I could move the cold voltage measurement up and down fairly easily, there was relatively little change in the range of voltage that temperature differences yielded. Adrian suggested that one might want to put an op amp chip into the circuit to get better resolution. Another way to approach this would be to use a higher resolution A/D chip instead. Microchip offers both a 12 bit, I2C compatible A/D converter and a 16 bit, I2C compatible A/D converter for about US\$1. That would get your resolution down to 0.8 - 0.05C. I don't know why you'd want more resolution than that. Errors in other part of the circuit would be much higher than that.

Given that I know how to make I2C comms work and next to nothing about op amps, that's the direction I'm likely to take.

RepRap At OSCON 2008

Thursday, 26th June 2008 by Vik Olliver



The RepRap Child is heading for OSCON in Portland, Oregon (yes, I'm off to the US of A again). I'm presenting in the last session on Thursday afternoon and will probably set up an impromptu display in the foyer if I can get away with it, so pop in and say "Hi" if you're in the neighbourhood.

Vik :v)

Java Host Software

Wednesday, 2nd July 2008 by Adrian Bowyer

I've changed the RepRap control panel in the Java host software so that it'll work under Java 1.5. It used to require Java 1.6 (which isn't on the Mac yet), so moving it back a step was a real pain. It's checked into the svn repository.

It's mostly there, plus a little added functionality. You can now pause a build, Sto(re) the current machine coordinates in the XYZ tab, hit the Rcl (recall) button to load those stored coordinates into the destination location, move the machine about, restock the extruder, etc etc, then hit Rcl again then Go there to get back to where you left off, then resume the build. It turns the extruder off when you pause, but doesn't automatically turn it on again when you resume (as you won't always want this). Turn it on in the extruder panel before resuming if that's what you want.

You need swing-layout-1.0.3.jar in your classpath for all this to work. This requirement will go away when we finally move to Java 1.6 (as its equivalent is in there already), but for the moment it's in the lib directory for your convenience.

Hacking the Solarbotics GM3 Gearmotor

Wednesday, 2nd July 2008 by Zach Smith

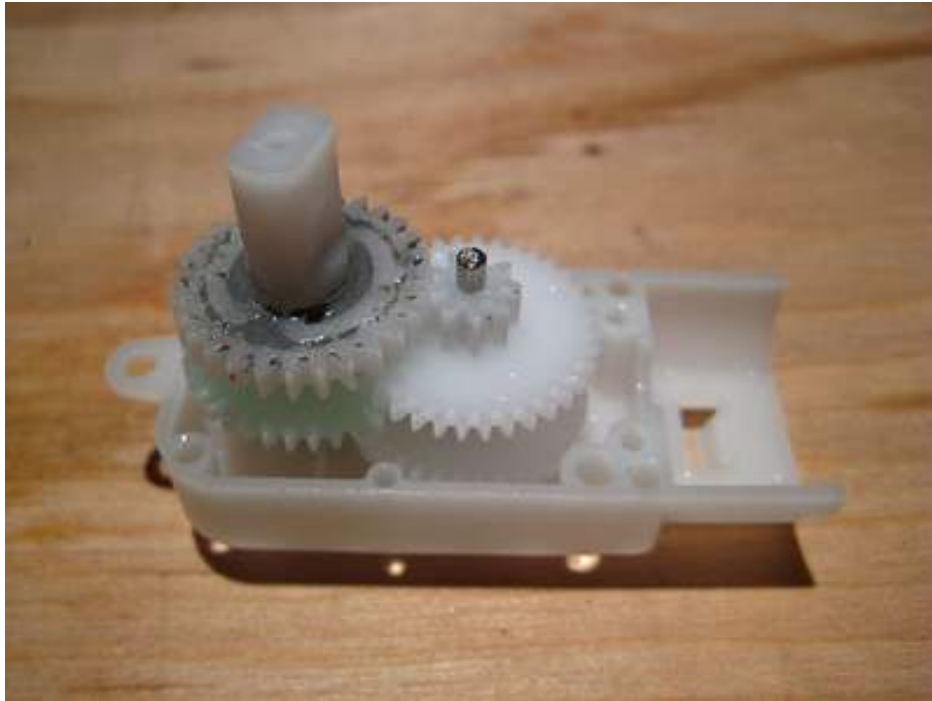

I finally got around to writing up a tutorial on how to hack the GM3 gearmotor to lock the clutch, which will prevent it from slipping when you try and torque it too much. It can definitely cause problems during printing, and this hack will make things much better.

[Read the tutorial](#), or [check out the flickr set](#).

Extruder instructions

Wednesday, 9th July 2008 by Adrian Bowyer

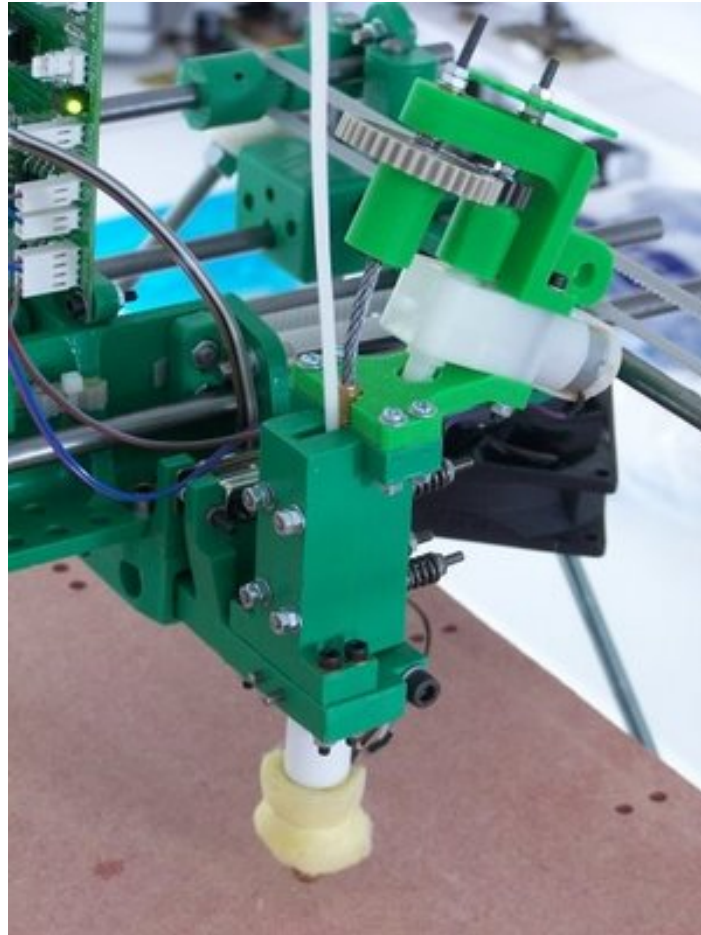

Apologies for the delay, but I have finally brought the [extruder assembly instructions here](#) up to date. Please let me know of any errors and omissions.

Multilingual Host Software

Saturday, 12th July 2008 by Adrian Bowyer

Thanks to Daniel Kessel, who has done a version of the RepRap Java host software that supports different languages. This isn't in the main subversion trunk yet, but if you want to experiment with it you can find it [here](#).

Revisiting the recycling of Reprap plastics

Saturday, 12th July 2008 by Forrest Higgs

The question of recycling waste products from a Reprap machine is revisited...

When the Reprap project was less than a year old the question of how one was to get the filament that the Adrian Bowyer's Mk II extruder, variations of which are almost universally used by Reprap and Repstrap machines today, required was entirely open. We were using polycaprolactone plastic at that time. Polycaprolactone would melt in a hot cup of coffee and Adrian, Simon, Vik and Ed were simply melting it and rolling it out in 3 mm rods on a sheet of glass.

I did the maths on that approach and soon realised that we were going to have to have continuous filament if we were going to print anything significant. That entailed us having some way to extrude filament. Adrian designed one for 3 mm granules and I designed another, smaller one, for powder resin shortly thereafter. We would have probably gone a lot further with this work except that the next month I discovered that the makers of plastic welding rods could provide us with all the plastic filament we wanted at very reasonable prices. That allowed the Reprap project to focus on actually making the printer.

Last Fall, Adrian revisited the idea but this time decided to go directly from granules to printing on the Reprap machine instead of making filament for a Mk II. He published the results of his work on the Reprap website.

The availability of a granule or powder resin supply begs another question, viz, are people printing with a Reprap machine like Darwin or Tommelise going to be buying such resin directly or are they also going to be attempting to recycle appropriate plastics, either scrap from their own printing efforts or scrap from elsewhere? If they are going to be recycling plastic they have to have a capability of reducing the scrap into a form that either their direct granule or filament extruder can cope with. That implies that you have some sort of shredder or grinder than can reduce the scrap.

A few days ago, in priority setting for R&D for the core Reprap project Dr. Bowyer included the development of a plastics shredder and further work on the granule extruder that he had published earlier. His rationale is very compelling...

But shredding RepRap's own products would be immediate, of course. I think this is worth doing intrinsically, and - less importantly - it is politically useful: "RepRap instantly and locally recycles its own products."

Heretofore, my thinking had been aimed at converting an entry level garden shredder for the task. You can get into the game with those for about US\$200. Dr. Bowyer's sense was that the cost should be somewhere around US\$40. He expanded on that...

I also think it should work very slowly; almost imperceptibly so, like a clock minute hand. Two

advantages to this: it'll be a lot quieter, and it can be run at much lower power. And I don't see why one would be in a rush.

Indeed. I'd never thought of it in that light. Adrian's feedback got me to rethinking the whole plastics grinding issue. Recently, I bought a rotary rasp and a rotary file while thinking of new approaches to pumping filament into heated extruder barrels. The rotary rasp was designed for my Dremel and was rather pricey at US\$17 while the file was much cheaper at about US\$3.50 but had a 1/4" shank that meant that I could only run it in an electric drill. Keeping in mind Adrian's notion that such a shredder, grinder in this case, should operate very slowly I did some informal experiments with that in mind. I first tried some scraps that I had of HDPE left over from a cutting board that I'd bought and cut up into several parts that I needed.

HDPE is a tough plastic. I'd tried grinding both HDPE and polycaprolactone (CAPA) before with a handcranked, old-fashioned meat and grain grinder some two years ago with different results. Since then I'd tried using several different kinds of grinders in a desultory fashion and noted that some of the HDPE grit that was produced tended to melt during the grinding and clog the grinder surface.

I began with the rotary rasp in my Dremel and ran it at the slowest setting possible with that very high speed machine.



Imagine my surprise when the rasp produced a relatively fine powder of consistent quality without clogging the rasp. Thus encouraged I tried the rotary file in my electric drill with much the same result.



The file, operating at much lower rpm ratings didn't clog either. While the grit that it produced was of a coarser quality than that produced by the rasp it would have worked perfectly in my old filament extruder.

This morning I decided to try to get a handle on how much power these rotary grinders were demanding. Repeating the experiment with the Dremel-mounted rasp while monitoring energy usage with my clamp meter I noted that depending on the speed I ran it at it drew somewhere between 0.21 and 0.5 amps (23-55 watts). The rotary file drew anywhere between 0.4 and 3 amps (44-330 watts).

Interestingly, the rotary rasp tended to clog as the speed pushed up the load towards 0.5 amps. It ran quite happily without grit melt at the lowest speed setting (0.21 amps). The file, on the other hand, was able to grind without melting the grit at upwards of 2 amps. The file, with its few cutting edges and larger mass seems to be subject to less mechanical heating and is, in any case, less prone to clogging by virtue of how it is designed. At 2 amps it was producing an impressive amount of grit.

While I haven't solved the problem of producing 3 mm granules from scrap plastic suitable for Adrian's granule extruder, I have produced a much finer resin grit which I suspect that his extruder would use just as happily.

Finally, assuming a very small, cheap grinder presumes that it is going to only grind small chunks of scrap plastic successfully due to its low capacity. That limitation assumes that one has a means of reducing larger chunks of plastics into something that the shredder/grinder can eat. Heretofore, I'd been achieving this end by using a hacksaw and heavy duty side cutters to achieve this end. Needless to say, this approach was both time-consuming and tedious. In that my brain was fizzing with ideas last night I wondered whether a simple bolt cutting tool could be applied to this problem.

Indeed, it could.



My US\$15 bolt cutters quickly reduced 3/8" HDPE to manageable chunks. I also used it to reduce an ABSinkjet printer housing. While the bolt cutter handled this job it seemed a bit overpowered for the task of cutting this much thinner plastic housing. I expect a heavy set of gardener's shears would do the job as well or better much more handily.

I did some tentative grinding experiments using the Dremel-mounted rotary rasp with the resulting ABS scrap with results very similar to what I got with HDPE.

New Board: Magnetic Rotary Encoder v1.0

Sunday, 13th July 2008 by Zach Smith

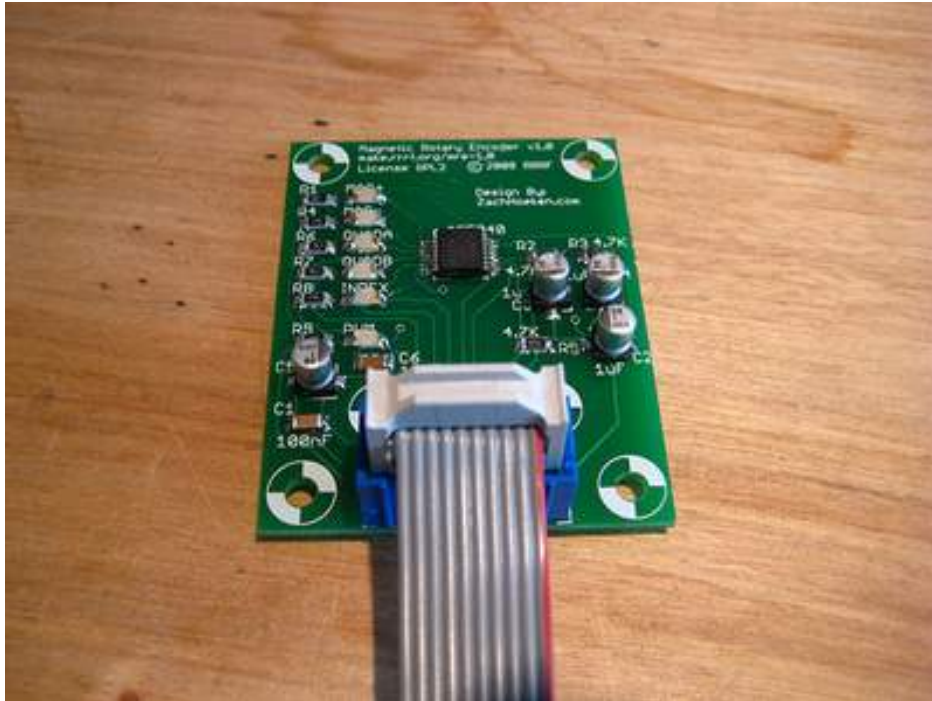

I'm very proud to announce a new board, designed and developed by the RepRap Research Foundation. Its called the Magnetic Rotary Encoder, and it uses a magnet to provide positional feedback information. It is based around the AS5040 chip, and provides 10-bits of resolution per rotation (1024 different positions!) It has 5 different output modes, a 6.1mm hole that fits the magnet for easy aligning, plenty of diagnostic LEDs for coolness, and 6 different mounting holes for ease of use, including GM3 gearmotor mounting holes.

Rotary encoding is one of the major innovations that Nophead uses in his extrusion process that has led to such high quality prints. Now, we have a standard, open source design that is intended for use with the GM3 gearmotor that we use on our extruder.

We have full documentation available on our wiki, an experimental GCode firmware for Arduino with support for it, and you can even buy a kit from the RRRF online store.

RepRap Child Now At OSCON in Portland

Monday, 21st July 2008 by Vik Olliver

The RepRap Child is now in Portland for OSCON 2008, hopefully not too badly beaten up in transit. Official presentation is on Thursday afternoon (5:20, D137) but I'll try to set it up in the foyer for folks to come poke at it. Will overcome jetlag before picking up screwdriver...

Vik :v)

OSCON RepRap Butchered

Tuesday, 22nd July 2008 by Vik Olliver

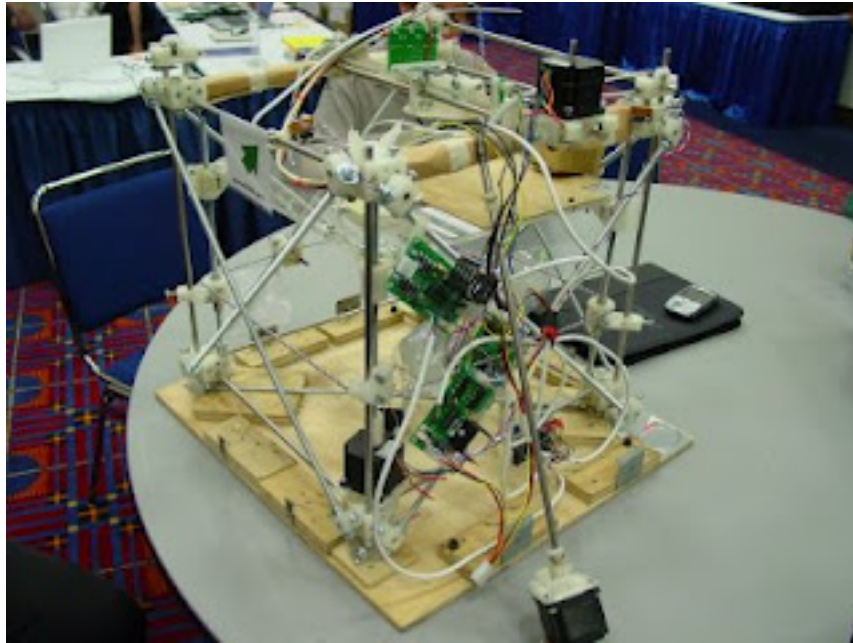

Looks like the airport baggage handlers have proved the minimum 98% chimp DNA content of humans, with the result that 3 corner brackets, the Y motor bracket and one bed corner are totally smashed.

Nice people at O'Reily have provided me with some epoxy, and so I'm busily putting the jigsaw back together again.

Vik :v)

Bits from Bytes RepRap now in Subversion

Tuesday, 22nd July 2008 by Adrian Bowyer

As many of you will know, Ian's company Bits from Bytes sells a lasercut version of RepRap:

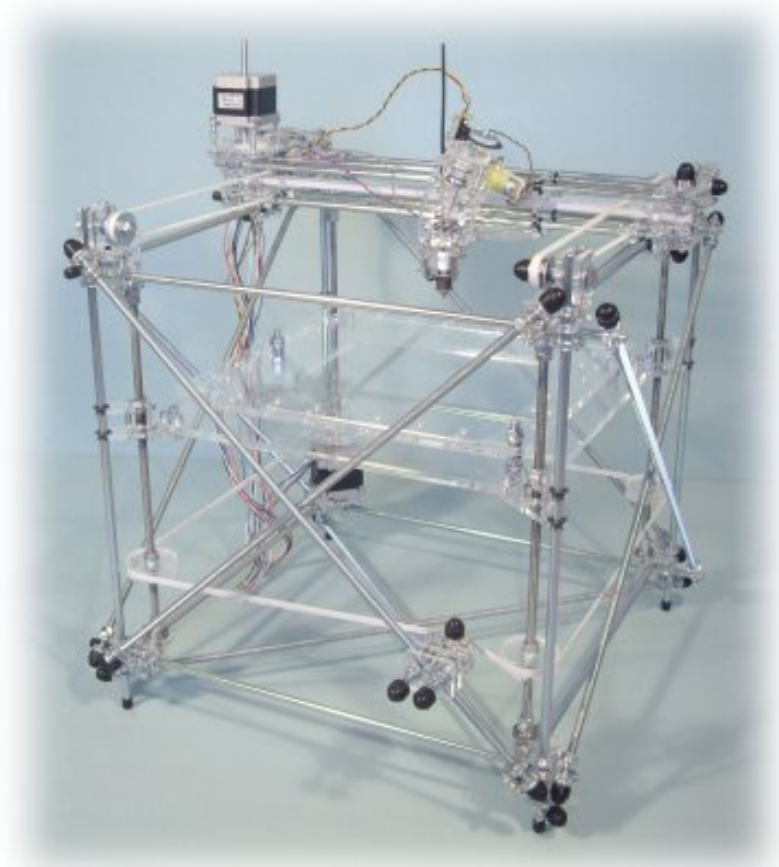

We have now put all the lasercutter DXF files in the RepRap subversion repository (under the GPL like the rest of RepRap) so that anyone with a lasercutter can make one. They are at:

<http://reprap.svn.sourceforge.net/viewvc/reprap/trunk/reprap/mechanics/bits-from-bytes-designs/>

Almost all the parts can be cut in 3mm, 5mm and 8mm acrylic; the file names give the thickness and material you need. (Just two parts are better made in acetal because they need to be slightly flexible.)

In addition we have started to upload the same parts as STL files so that, of course, RepRap machines can make them too. They are in the STLs-for-reprapping/ sub-directory from the above location. Only the extruder is in there at the moment, but we will add the other parts as soon as they have been translated.

Adrian & Ian

Minor notes on the Zach's Opto-endstop PCB

Tuesday, 22nd July 2008 by Forrest Higgs

Two minor notes on Zach's opto-endstop PCB for Darwin...

After doing the final assembly of the y-axis for Tommelise 2.0, I decided to wire in the opto-endstop for that axis before going on to the x-axis.

I bought a handful of the Zach's Darwin opto-endstops shortly after he took delivery on his first batch of these thumbprint-sized PCB's. The two items that I will be discussing here might not apply to later versions of the boards since Zach is meticulous about correcting problems on his board design on-the-fly, as it were. It would be good to check on yours, however.

Over the last few years I've collected an impressive inventory of electronic components. When I started to assemble the board, therefore, I was able to pull the 10K Ohm and 220 Ohm resistors from stock. Interestingly, the board had obviously been designed with 1/4 watt resistors in mind. The 10K Ohm resistor was rated at 1/2 watt and was considerably bulkier than the 220 Ohm resistor that also used in the board assembly. I had to bend the connector wires for the 10K Ohm resistor under it to meet the holes in the PCB.



You can see in the pic how that worked out. It works, but looks awkward. Widening the spacing between the holes for the resistor would help for those of us who use whatever resistor comes to hand make a better job of the board.

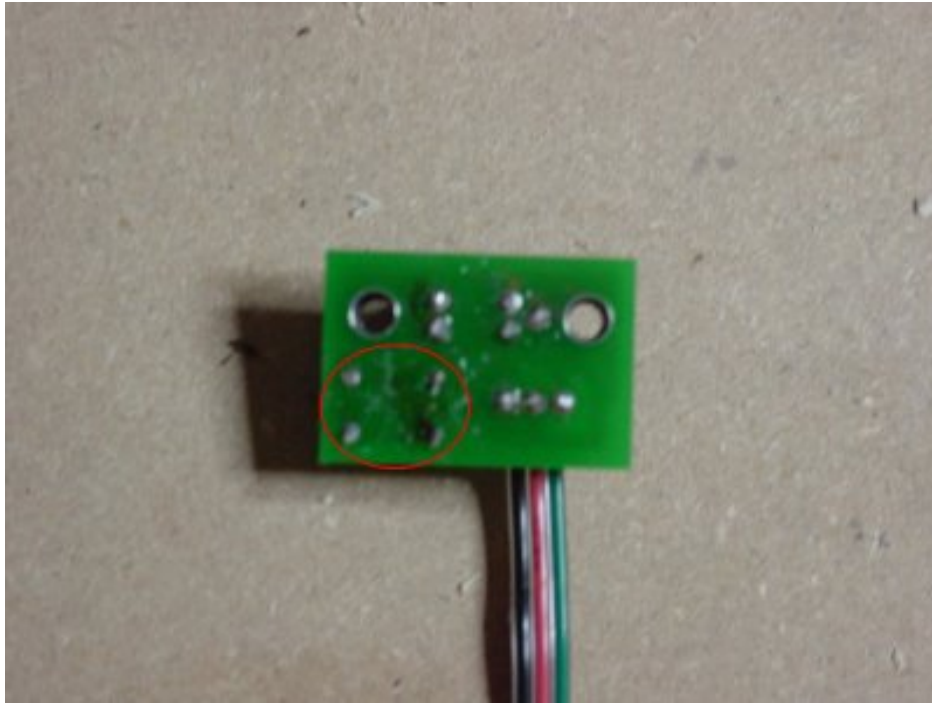

More alarmingly, the back-side soldering pads for the resistors (inside the red circle of the above pic) were virtually non-existent compared to the other connectors. This made securing the resistors electrically to the circuit something that I had to do quite carefully and then check with my multimeter to make sure that they were connected. If this problem hasn't already been corrected on the most recent prints of the board, it needs to be.

Aside from those notes, the little opto-endstop board that Zach kindly designed for the Darwin printer is brilliant and I am sure will work just as well on Tommelise 2.0.

A bit more about Zach's opto-endstop

Wednesday, 23rd July 2008 by Forrest Higgs

A small sharing of experience in incorporating Zach's ZD1901 opto-endstop into a controller board...

Hooking up Zach's opto-endstop was a trivial exercise. You provide ground, +5 v and get back a 5 v signal. To receive the signal from the opto-endstop, I set PortB.5 to an input by setting TrisB.5 = 1. I then rewrote the test program for the y-axis to reset the start point for the axis when it got a good signal from the opto-endstop.

It didn't work the first time out for reasons which caused me to include this short note. I tend to do temporary lashups with sticky tape and the like to test things. The thinking is that once I have everything running I can design proper mounts and such using Tommelise 2.0 and print them out, replacing all of the bits of wood and tape. This opto-endstop mounting was no different.

I had, of course, to use something to break the signal in the H21LOI. For that I cut a strip out of a piece of red construction paper, reasoning that it was thick enough and opaque enough to do the job. I was wrong. It wasn't.

From there I selected a much thicker piece of white paper of heavy poster quality with a heavy clay fill. No joy.

When I took a piece of carton (cardboard) off of the back of a shrink package of 16 pin sockets from Radio Shack and dipped that into the gap of the H21LOI I got a good signal back. I then cut a long strip of similar carton off of the side of a package of hack saw blades and taped it onto the y-axis. I also taped that opto-endstop to the baseboard of Tommelise 2.0 as you will see.

[Resetting the y-axis with the H21LOI opto-endstop from Forrest Higgs on Vimeo.](#)

That done, the test routine performed perfectly. The moral of this story is never underestimate the penetrating power of the IR beam in a ZD1901. It may not look like much, but it is nonetheless powerful.

One other thing gave me pause which I will mention for completeness. Ordinarily, my controller boards include a L9805CV voltage regulator that converts 12 v from my ATX power supply to 5 v for the logic circuits on the controller board. I don't use a heat sink on the regulator simply because the load that the logic chips put on it is not substantial.

When I put new circuitry on a board, however, I tap it briefly at frequent intervals to check to see if

it is heating up, that being a sure sign that I have a short somewhere on the board. This evening I noticed that it was warmer than usual. Without the opto-endstop the regulator was relatively cool to the touch. With it it was warm. Not hot, but warm. I checked my wiring additions and there were no shorts. I also tapped all of the chips checking to see if any of them had gone bad with similar negative results.

Being obsessive, I checked the amperage going into the board via the 12 v input while the y-axis plus opto-endstop was in operation and got 190 milliamps. I also checked the 5 v supply going to the opto-endstop board and got 20 milliamps.

Finally, I used my IR thermometer to measure the temperature of the regulator and got 36 Celsius. Room temperature was 21 C. Apparently the drain from the endstop board is warming the regulator up a bit, but not alarmingly.

In future, though, when designing controller boards I will place the L7805CV somewhere else on the board where I can slap a heat sink on it easily. A heat sink will let it happily handle loads up to 1 amp.

Every little helps

Saturday, 26th July 2008 by nophead

The Darwin design has 10 diagonal tie bars across the corners of all but the top face of the cube, making it very rigid. These are attached by 20 diagonal tie brackets: -

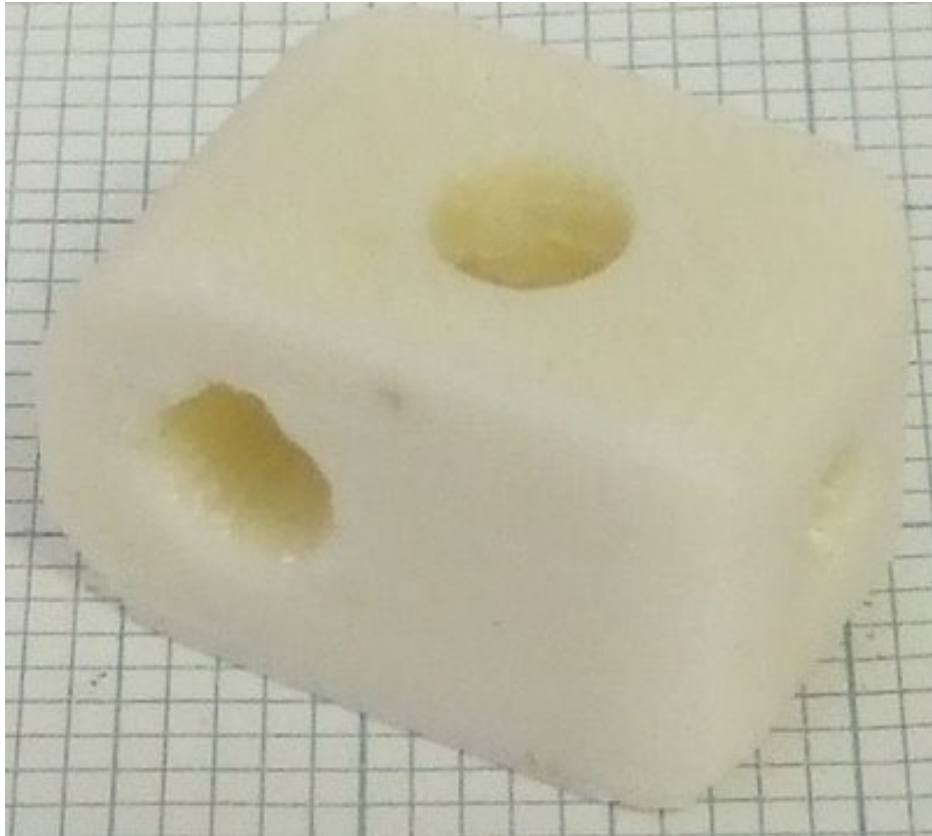

The brackets are held onto the protruding 8mm stubs by M5 set screws through a captive nut. The diagonal bars are then held in place by M8 nuts either side of the bracket.

When fitting them I noticed that the set screws and nuts are not necessary. All the holes I make come out a little undersized and stringy so I clean these out with an 8mm drill. This makes them an interference fit onto the M8 rods. The force exerted by the M8 nuts is enough to squeeze the bracket to make it a tight fit. This is the case when they are made from ABS with 25% fill. Other plastics may be too strong or brittle.

This shortcut saves 20 grub screws and nuts and the time to fit them (inserting the nut can be quite fiddly). Not only that, the bracket can be simplified and made smaller because it does not need space for the nut and grub screw. This optimisation is well worth doing because, although these brackets are quite small, there are 20 of them so they are a significant part of the time taken to replicate.

Here is my smaller design which uses 21% less plastic and reduces the time to make 20 from 11.5 hours to 9 hours on my machine :-

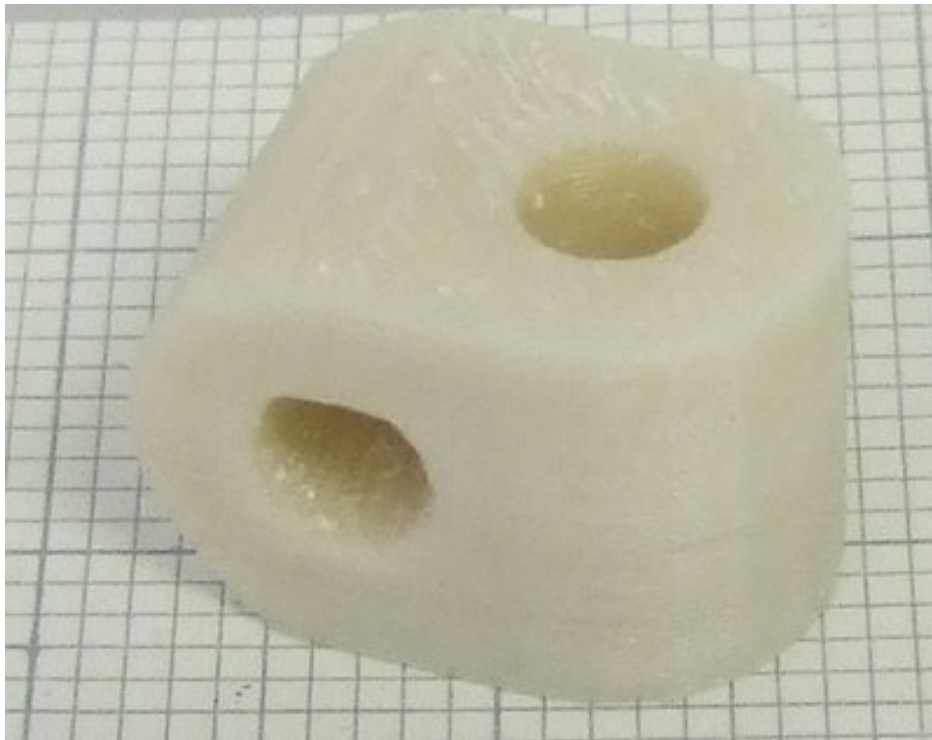

I also used a truncated teardrop for the lateral hole. This relies on the fact that filament can span gaps as well as being able to build out at 45° . The drawing below illustrates that, even for an 8mm hole, the difference between a proper circle, which would require support material, and this truncated shape is very little. It also shows where the full teardrop would extend to.

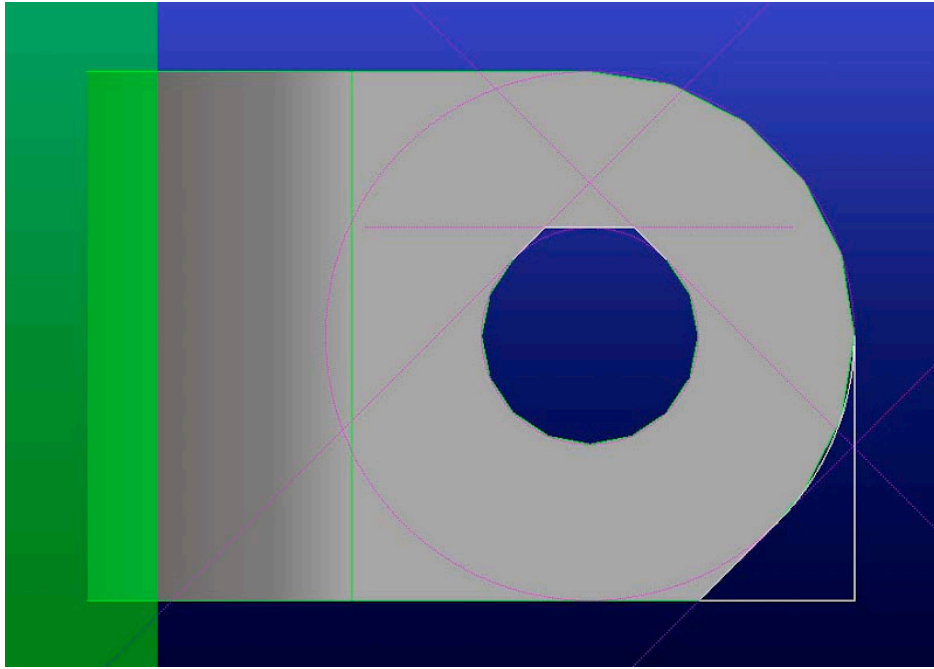

Here is a picture of it installed alongside the old design: -

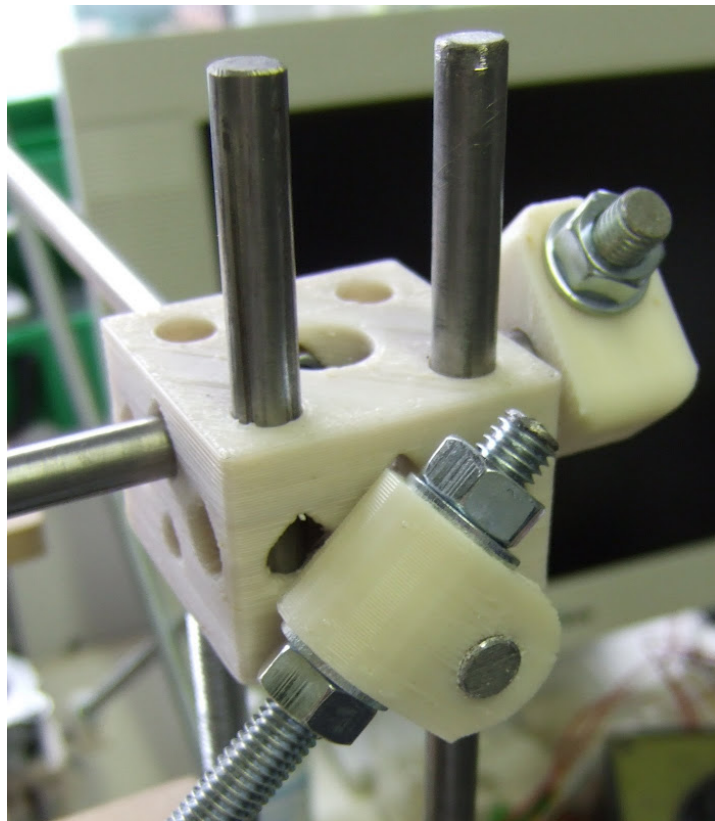

I think this is a beneficial mutation that will slightly increase the rate at which Darwins reproduce in the wild. The new DNA can be found [here](#).

Foundations

Monday, 28th July 2008 by Adrian Bowyer

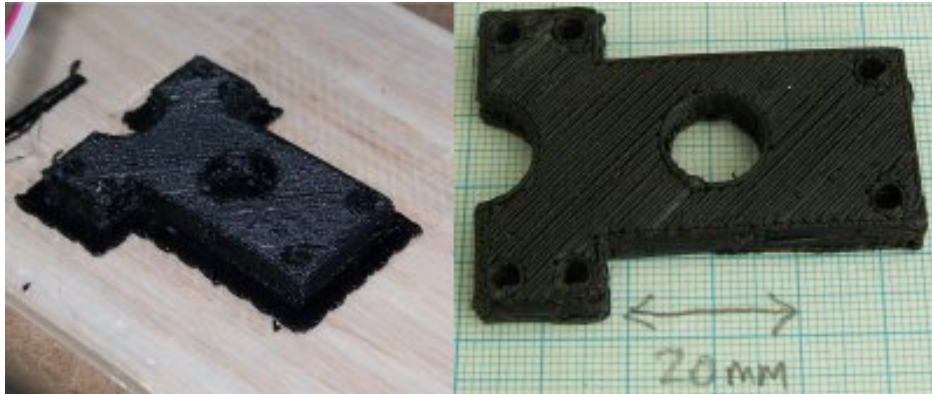

"Thou shalt raise up the foundations of many generations, and thou shalt be called, the repairer of the breach, the restorer of paths to dwell in." Isaiah 58:12

Well. It seemed appropriate...

Inspired by Nophead's outstanding experimental results, I've added code to the Java host software (in the repository [here](#)) optionally to put foundation layers under a build. This works particularly well with ABS (above - not yet up to Nop's quality, but servicable). I suspect it should also work with PLA, though I haven't tried that yet.

The host starts by putting down several widely-spaced hatch patterns on top of each other, then a narrower pattern, but still with horizontal gaps, then finally a hatch at the normal infill horizontal hatch gap. This last layer, though, is not the standard height-gap above the previous one, but less. This means that it is forced into the gaps in the previous layer, giving a very strong bond. The first layer of the part is then plotted where it should have been had the gap not been reduced, giving a bigger gap than normal between the part being made and the foundations. Consequently it doesn't stick that firmly to the foundations and can be separated easily with a penknife blade.

Nophead has found that this process is sensitive to ambient temperature (hot days give more stick), so we may have to allow for that. He suggests simply lowering the extruder temperature by the same amount that the ambient temperature exceeds some norm (say 20 °C)

Foundations allow us to do two things:

1. Build on an absorbent or rough base to give good keying. This will prevent parts separating from the base as they cool and tend to curl up. The part above (the [direct-drive extruder motor mount](#) - see that link for what it does) came out flat as a pancake, even though ABS is prone to

curl.

2. Experiment with layer separation strategies (like the changes in layer height that I mentioned).
Once that is fully understood (or even before...) we can use the polymers as their own support for overhangs.

TSA Really Wreck The RepRap Child

Tuesday, 29th July 2008 by Vik Olliver

On the return journey from OSCON, baggage handling found themselves outclassed. Instead of simply smacking the box around a few times as had happened on the outbound trip, the TSA dismantled the custom hard-case for the RepRap by removing the 16 bolts securing the top panel rather than undoing the 8 bolts marked "Open".

Unable to fit the panel back on again - it was not meant to come off so the nuts were not captive - they simply sent it on its way with the panel detached. I retrieved it from the conveyor - as opposed from the fragile/outsize section despite clear "Fragile" stickers on every face - being shipped in the

T
h w
i a u <==
s y p

configuration. Bits were still spilling out of it. Two of our suitcases were badly damaged, my daughter's hard suitcase on a separate return flight was also destroyed. It was replaced by Air New Zealand with an apology for circumstances genuinely beyond their control.

I recommend that anyone, anywhere shipping any equipment of value by air goes out of their way to avoid having it pass through the United States of America. Otherwise their badly-trained insecurity chimps and box-throwers will wreck it for you.

An affordable alternative to JB-Weld and BBQ paint?

Thursday, 31st July 2008 by Forrest Higgs

Cheaper alternatives to Cerastil for securing nichrome heater wire to extruder barrels may be in the offing...

Nearly two years ago when Adrian invented the Mk II extruder, the basic enabling technology for Reprap and pretty much any other low cost 3Dprinter project you'd care to name, he dealt with the problem of attaching the nichrome heater wire to the extruder barrel by wrapping the wire in PTFE tape, a very unsatisfactory solution. I found insulated nichrome wire which helped matters a bit but that was never quite a satisfactory solution and before too long we were experimenting with things like BBQ paint, which I still use, and JB-Weld, a high temperature epoxy which is in wide use in the Reprap community. The problem is that BBQ paint has to be refurbished about every hundred hours and JB-Weld simply perishes in a similar time period.

Recently, Chris Palmer (Nophead) discovered Cerastil, a German high temperature ceramic cement, which gives wonderful results but costs about \$200/kg. The problem with Cerastil is that the minimum size is a kilogram and you only need a few grammes to attach nichrome heater wire to your extruder barrel. A few weeks ago I went hunting for a cheaper alternative to Cerastil. I ran across an American firm, Cotronics, which offered what may be a close match for Cerastil for about \$50-60/kg. I took delivery on some this afternoon.



I will be trying to use Resbond 989FS to build up one of my thin-walled extruder tubes within a week or two.

Resbond 989FS seems to be slightly superior to Cerastil H-115 if the spec sheets are to be believed and much, much cheaper. On the negative side it comes premixed and the bucket is listed as having a shelf life of 6 months at room temperature. I immediately put it in a ziplock bag and tucked it into the fridge to see if I could do better than that. While cheaper, Resbond still comes in what amounts to 1 kg lots, which is enough to finish hundreds of extruder barrels. Cotronics was kind enough to send across their catalog, however, and paging through it I discovered that they

had another product, Thermeez7020, which isn't quite as strong, but handles heat equally well and, more importantly comes in both standard caulking tubes for about \$18 and in 4 oz tubes for \$26.50/(package of 3). That last looks to me like it may be about what an individual Reprapper might want to be using.

Components	1	1	2	2	2	2	1
Working Time	N/A	N/A	10 min.	20 min.	1 hr.	30 min.	N/A

Resbond Ceramic Putty
3000°F Thermal Insulation in a Tube



Thermeez 7020 Ceramic Putty is formulated with high purity, "Asbestos Free", Aluminum Oxide ceramic and Cotronics' unique binders. No mixing required. Just dispense from standard caulking cartridges and cure at room temp. to produce a strong, ceramic body that is usable to 3000°F. Provides excellent resistance to electricity, molten metals, most chemicals, oxidizing and reducing atmospheres. Use for instant repairs to ceramics, bricks, mortar, burner blocks, insulation, furnaces, holders, thermocouples, etc.

Applications Include: molding and bonding ceramic fiber components, insulation of pipes, supports, burners, turbines and rigid metal handling applications and brazing fixtures.

Description **Price**

Check out the pic. Those are, unless I am mistaken, heavy duty nichrome heating coils that they are applying that Thermeez to. That speaks well for its applicability for our purposes. Now. Who's going to buy and try this stuff? Me again? :-)

My bad: another note about compact flash cards

Saturday, 2nd August 2008 by Forrest Higgs

In which the narrator discovers that SD cards are indeed workable, thanks to Jonored...

Jonored pointed out that we weren't talking about CF cards but rather SD cards. A frantic search through the Mikroelektronika BASIC manual unearthed an SD schematic this time.

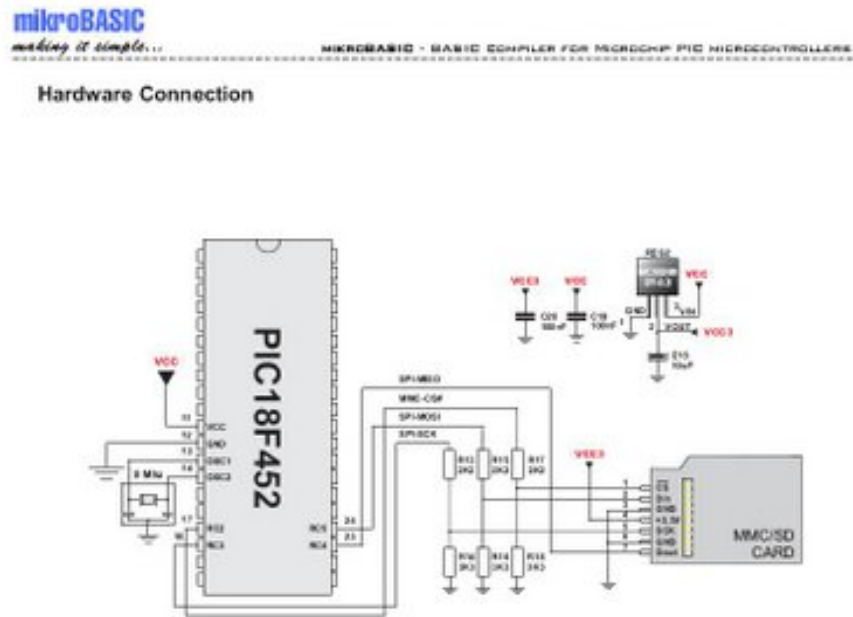

The SD card only requires 4 pins. THAT's possible and very attractive depending on how much flash memory the handling routines for SD cards require.

A note about compact flash cards

Saturday, 2nd August 2008 by Forrest Higgs

A possible practical argument against using compact flash cards for memory buffers with Reprap machines...

Recently, I've been thinking about moving over to the MikroelectronikaBASIC PIC development environment for Tommelise 2.0, not because it really needs the capabilities of this somewhat more expensive app, but rather because of some robotics work I have planned for next year which will require the use of at least Pic 24F controllers. While thumbing through their very detailed users' manual I noticed something that might bear on an extended discussion that we have been having about the relative merits of various ways of appending print buffers and off-line printing capability to our various approaches to controlling Reprap machines.

Compact flash cards have been a much discussed candidate for this role. When I discovered that Mikroelectronika had a library for handling this sort of device, I was naturally interested. My interest was rather lessened when I got a look at their sample schematic.

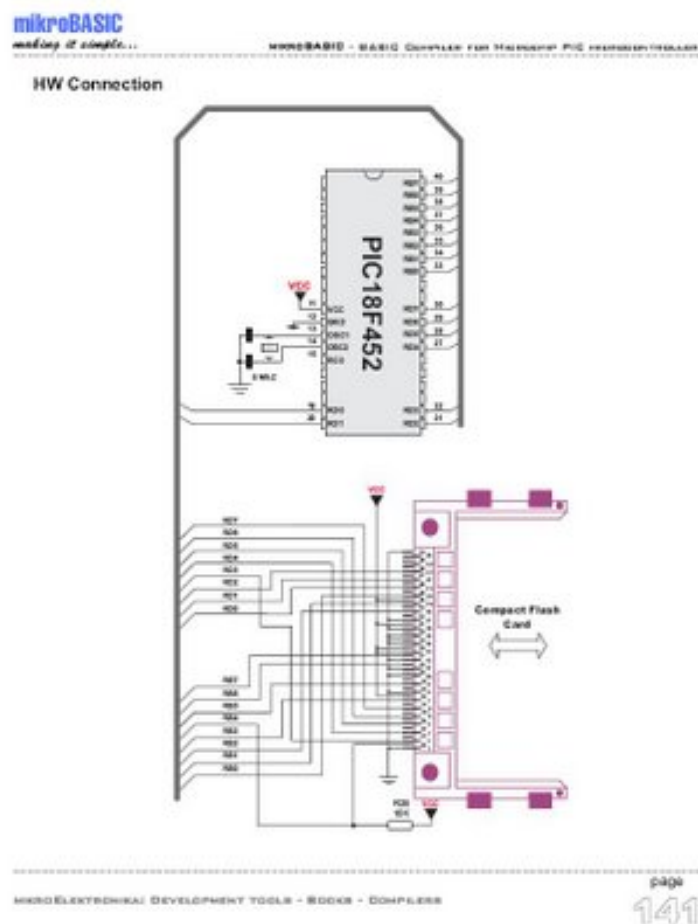

The long and short of it is that it appears that to implement such a storage device you are going to require two full ports. For a 40 pin PDIP controller chip that is a LOT and leaves you precious little left to actually control your Reprap machine.

Just in passing, Mikroelektronika has what more or less amounts to a Visual Studio situation for microcontroller programming, that is, they have identical compilers in BASIC, Pascal or C depending on your taste in computing languages. BASIC is the cheapest at \$149 while C, of course, is the most expensive at \$249. They also carry a huge selection of premade development boards the variety of which reminds me more than a little of Arduino. Interestingly as well, they offer boards and, I think, compilers for the ARM chip.

As long as NATO doesn't decide to bomb Serbia again, I think they will be a reliable supplier.

Extruder alternatives

Wednesday, 6th August 2008 by Adrian Bowyer

At Nophead's suggestion I've started a [page here on improvements and alternatives in the construction of the polymer extruder.](#)

The first couple of things I've added are a direct drive, which eliminates the need for the flexible coupling:

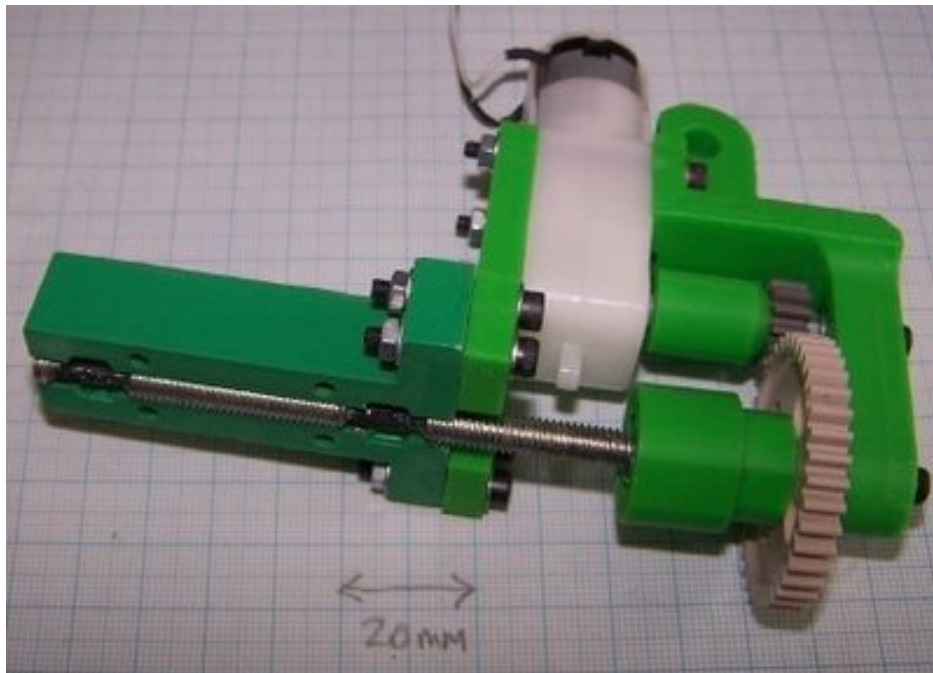

And a high-temperature heater design using Ian's idea of fire cement that will outperform JB-Weld-bonded ones:

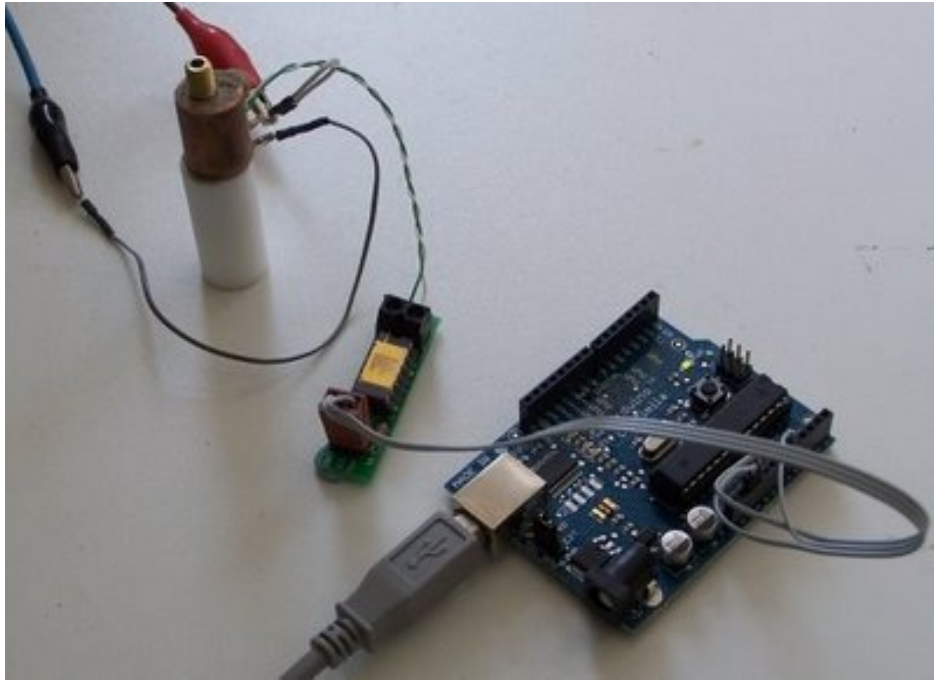

That also uses Zach's thermocouple driver board, rather than a thermistor. This will go higher in temperature, and also gives a linear output. I've also added the code to the Single Arduino firmware to support the thermocouple.

Announcing: Sanguino v1.0

Friday, 8th August 2008 by Zach Smith

I'm super psyched today to announce the Sanguino, a new microcontroller board I've been working on for the past month or so. As you know, we've been using Arduino as the recommended microcontroller to control a RepRap machine now for a while. It works, but we've pretty much maxed it out. The Sanguino is an Arduino-compatible board that boasts 4x the memory, 4x the ram, and 12 extra pins. Its a sweet board that gives us some room to expand while still being completely through-hole for simple assembly.

You can read more about it on the Sanguino.cc website, or buy a kit from the RRRF for \$25.

Sanguino: Arduino's Big Brother from Zach 'Iowa' Hoeken on Vimeo.

Going for an EDM toolhead

Sunday, 10th August 2008 by Forrest Higgs

In which the narrator decides that if an EDM toolhead is going to get built he'd better get on with it...

For the past year or so, I've been mouthing off about how it would be nice to have an Electric Discharge Machining (EDM) toolhead for Reprap. This weekend, after I overcame what I think is the last major technical hurdle in designing and building Tommelise 2.0, I began to wonder what I ought to be doing to keep my mind challenged for the next six months or so.

I already committed to seeing if I could move tin-can linear stepper technology a couple of notches closer to something that a Reprap machine could print major parts of. I've got most of the parts for that and am starting to cobble together a first try at making a crude tin-can stepper using ring magnets. The problem with that project, which I will continue to work on, is that it doesn't benefit the wider Reprap community that is building belt-driven Darwins and not linear stepper-driven Tommelises.

That's when I got to thinking about Electrical Discharge Machining (EDM). A lot of people in the Reprap community have been talking about wanting their Reprap machines to be able to do milling. The problem with that is that you need a much more robust positioning system and very different software to develop the tool trajectories for ordinary milling and shaping toolheads. Milling puts loads on the positioning system that printing plastic doesn't. EDM, on the other hand, doesn't load the positioning system either, aside from its having to support a dielectric bath to contain the piece being milled. That's a little tricky, but if you keep it shallow enough and don't run your positioning system (in Tommelise's case) fast enough to cause sloshing, you're good to go.

A few months ago, I started to get read up on EDM by getting a free subscription (sorry guys, American only for some reason having to do with postage, I think) to EDM Today. Yesterday, though, I went ahead and bought two books on how to build a desktop-sized sink EDM machine. I also joined a chat group of people who are building such machines, the EDM Home Builders run by the author of one of the books I bought, Ben Fleming. Ben even sells a ready-made PCB for his machine.

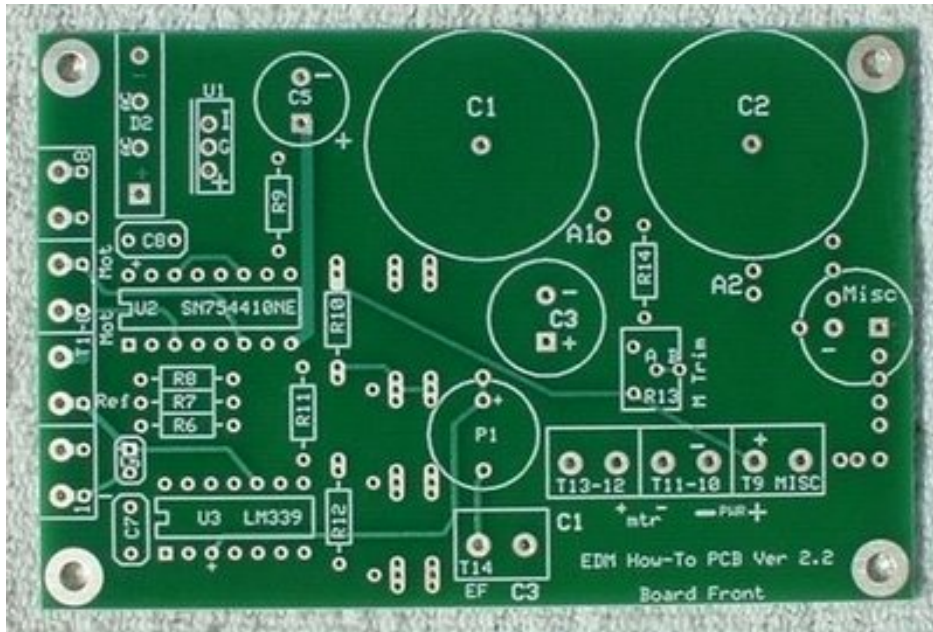

A sink EDM machine basically lowers an electrode cut into the shape of what you want removed from the billet. If you use a thin, stiff electrode, according to what I've been reading, you can shape surfaces if you mount the tool head onto an xyz positioning system.



If you want very fine cuts, however, you have to go to a wire EDM machine. It works a bit like a scroll saw.



Camtronic sells what I am told are a great set of plans for this sort of machine. While a wire EDM machine can make very fine cuts with great accuracy, I am told, it has a very limited ability to shape in 3 dimensions.

In any case, I've felt for a long time that we are going to have to be able to deal with structural materials other than plastic if we are to reduce the number of parts that our 3D printers can't make. I am going to see if it is practical to use a EDM toolhead to achieve this end.

RepRapped Shaft Encoder

Tuesday, 12th August 2008 by nophead

I have RepRapped a simple shaft encoder for the direct drive version of the extruder.

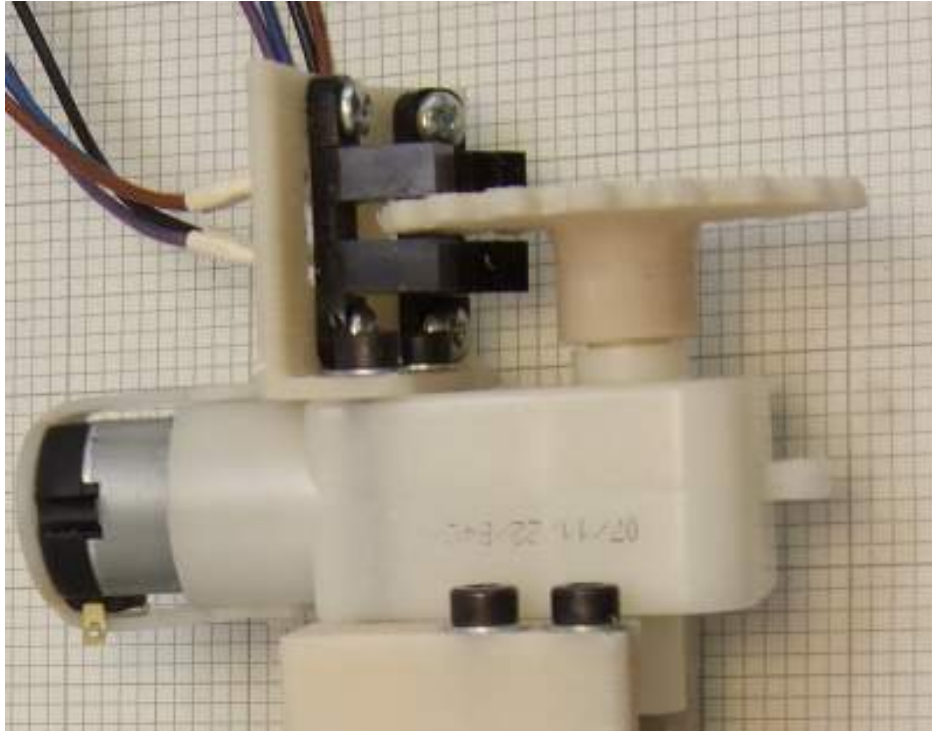

Read more about it here: hydraraptor.blogspot.com/2008/08/reprapped-shaft-encoder

RepRap Parts Lister Update

Friday, 15th August 2008 by Zach Smith

A while back, I created a little software project for RepRap called the Parts Lister. I was attempting to assemble my darwin, and I needed to know how many M8 nuts I needed. At that time, we had an HTML table with all the various assemblies broken out (X axis, Y axis, etc.). I had to go through each of the assemblies and tally up the total number of M8 nuts to make sure I was buying enough.

That experience drove me to create the parts lister, which is a database of all the various modules the RepRap project has created. This allows us to do lots of cool things, like generate parts lists with multiple suppliers that show you the totals, what parts are used where, etc. Its a nice little system.

Yesterday, I hacked on it and added a couple new features:

* You can now embed individual module part lists on any website using an iframe. the data itself actually lives in a Google Spreadsheet and gets imported to MySQL by a script we wrote. Up until now, we were actually embedding each individual google spreadsheet on the appropriate page. This was nice, but it only told you what parts you needed. Now we can embed the part lister page on a module page, and it will not only show you what parts you need, but it will link you to a page where you can find out *where* you can get them from. I've updated the recent electronics pages with these embeds, so you can see them in action.

* I added support for our 'legend' table so that the main page of the part lister is no longer so cluttered. It now breaks down the various modules into 'Production', 'Beta', and 'Obsolete' components so that you can easily tell the difference between the various modules.

We're constantly striving to improve the RepRap project, and every little bit counts. If you have any suggestions, or you'd like to get involved, there are lots of opportunities, even if you don't know anything about electronics or 3D printers.

Cheers,
Zach

Belt tensioner

Saturday, 16th August 2008 by Vik Olliver

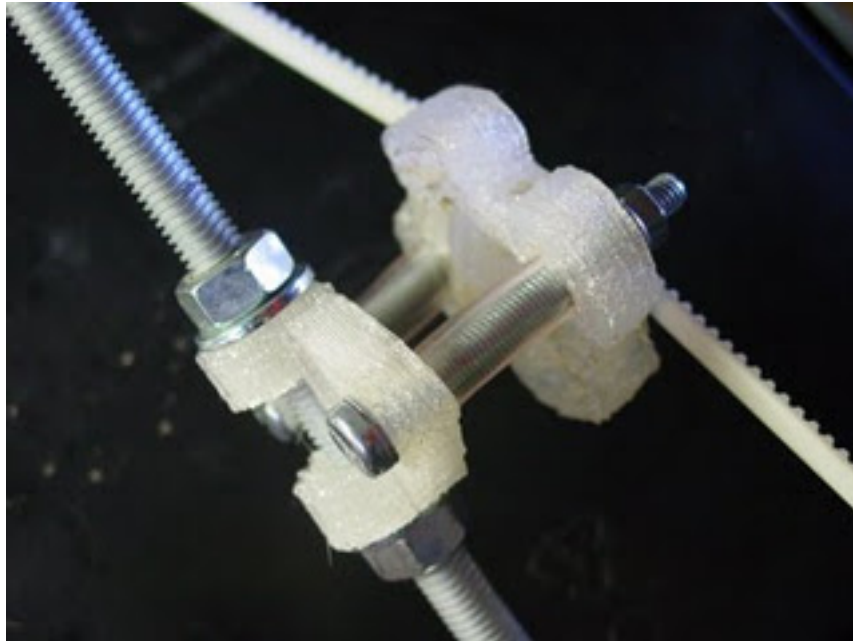

One RepRap part not covered much elsewhere is the belt tensioner. Here's the one fitted to my Darwin - it was printed out on aforementioned Darwin using a screwdriver in a clamp-down vice as an impromptu tensioner.

There is another version for ball-chain with a groove in the idler. These allow you to tension up the belt without moving the position of the Z posts.

The design is a little unusual in that I have used a piece of 3mm PLA filament as the axle for the idler wheel instead of the usual M3 bolt. To fix it in place I simply heated one end and pulled it into the body of the idler holder - instant welded axle.

I've just designed one for the lasercut RepRap kit. Hopefully I'll get that run off next week and we'll see how well it works in practice.

Vik :v)

Blood on the carpet...

Sunday, 17th August 2008 by Adrian Bowyer

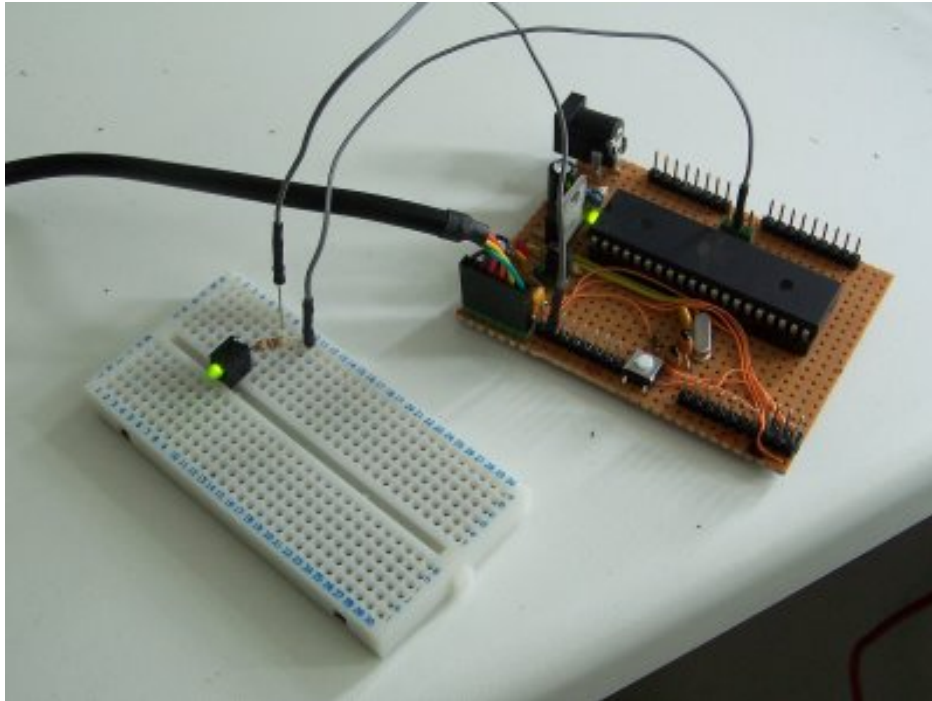

I soldered up one of Zach's Sanguinos on stripboard from the circuit diagram.

He intends it as an easy replacement for the Arduino with more pins, more memory, more ... well, everything, really.

Getting the bootloader in was a bit of a mission. I cut the old Centronics plug from a legacy printer cable and made one of these in-circuit programmers.

The first problem was that Pin 18 on the printer cable D socket (see the hand-drawn circuit) was not connected to any wires in the cable. But it's obvious that that is just the ground connection, so I found a wire that was connected to the metal cable shell and used that.

The second problem is that you can't easily drive the pins on an old-style printer port from Linux, so I had to use a Windows machine. I downloaded the giveio package from MIT and ran the program `install.bat` from it, but things were still not talking properly.

The Arduino bootloader page told me that it was Windows polling the parallel printer port to see if anything was plugged into it that was causing the trouble. The fix is to edit the registry (Run -> `regedit`), then go down the tree to:

```
HKEY_LOCAL_MACHINE\SYSTEM\ControlSet001\Services\Parport\Parameters
```

(in fact, my Windows didn't have Parameters at all, so I had to create it), then set "DisableWarmPoll"=dword:00000001.

Things still weren't right. In Zach's file boards.txt there is a line:

```
sanguino.bootloader.path=atmega644
```

that should read:

```
sanguino.bootloader.path=atmega644p
```

Zach's going to correct that asap, but the man's on holiday: give him a break...

Finally, I could burn the bootloader :-)

Then everything sprang to life :-))

I could download test programs, flash LEDs on pins (see above) and so on.

At the moment my Darwin is printing out parts in ABS for Ian's extruder design to make sure we can rewrap them as well as lasercutting them. When that's done in a week or so, I'll rip out the Arduino and put this new-fangled Sanguino thang in and see if we can use that. It should use identical RepRap driver electronics to the Arduino, so it ought to be straightforward (hollow laugh offstage...).

Watch this space...

Milling plastic with a Reprap machine?

Monday, 18th August 2008 by Forrest Higgs

It might not be impractical after all...

Back in April and May of last year, Nophead took a look at milling plastic on his reprap machine. Unlike most of us, Nop simply bought a proper xy platform and went from there. That decision, combined with his very thorough and thoughtful way of approaching problems has made him the treasure of a resource to the Reprap project that he has become in the time since.

Parts being almost impossible to come by in those days, Nop resolved to mill his own extruder. I wasn't following his blog regularly at that time and missed much of what he went through. At first he bought a spiral saw which could rev up to 30K rpm. For some reason, though, it proved inadequate, so he acquired a minidrill that could hit 20K rpm from his aunt. He used this one thereafter.

That decision made, he proceeded to try to mill some styrene...



... with indifferent results. He noted at the time that...

Imight be wrong but I think the snatching is due to the set up not beingrigid enough. I had already identified that as a weak point and the newmotor mount was aimed at improving it. The first drill was supported atboth ends but this one is too short so it needs a much stiffer mount,which is what I was trying to make! Perhaps the end mill bit is notsuitable for styrene, or perhaps styrene is not very machinable, orperhaps the RPM is too high, or too low.

...and decided.

Onething I can do to improve stiffness is to replace the 2mm aluminiumplate with the 6mm slab I already bought for the job. I was puttingthat off until I got the new mount so as not to have to drill two setof holes in it.

And subsequently managed quite nicelywith the string of results we've all benefited from today. It also leftus, however, with the impression that has since turned into a receivedwisdom that it isn't really possible to do milling work on things likeplastic with a light framed Reprap machine.

Extruder valve

Tuesday, 19th August 2008 by Adrian Bowyer

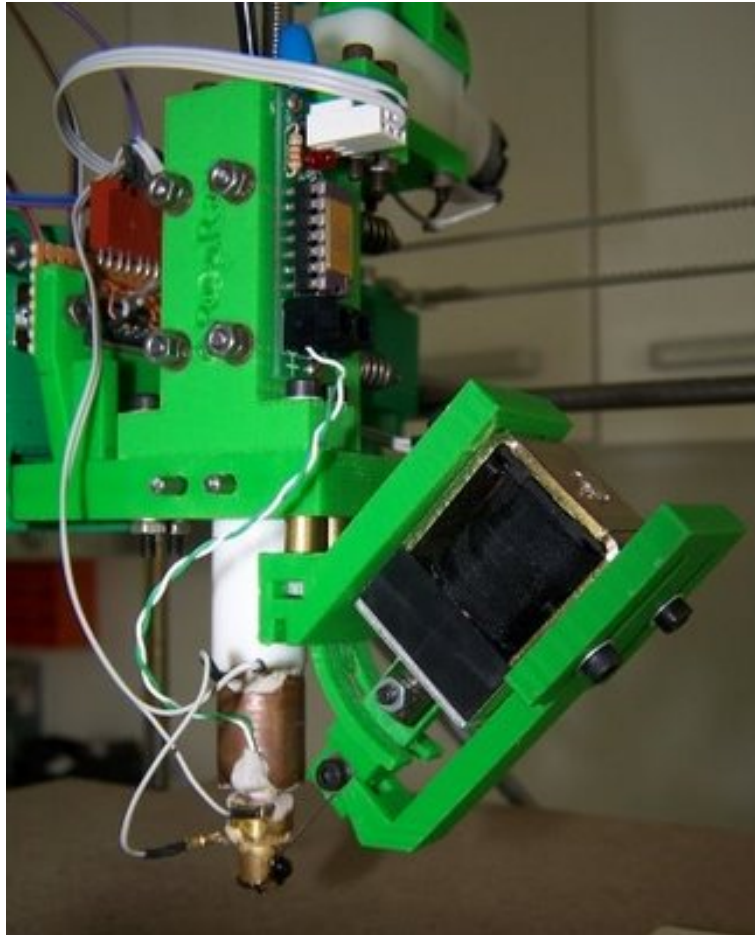

I've been working for a while on a valve to control the flow of the polymer from the extruder. The design above owes a lot to both Ed and Ian, and works reasonably well (though it leaks a little slowly at the side, as you can see).

I've documented it on the [Extruder Improvements and Alternatives page here](#).

It consists of a latching solenoid that pushes a piece of stiff piano wire across the exit to the nozzle, blocking it. This doesn't completely stop the flow, but it does eliminate a lot of leakage. It also allows tricks like starting up the extrude drive motor with the valve closed, building up a little pressure, then opening the valve to ensure a clean sharp start to polymer deposition. Controls for all that sort of thing are available in the RepRap Java software and in the Arduino (and PIC) controllers.

The big problem that this design overcomes, and the reason that it is a little complicated, is that of getting the nozzle and the wire holes to cross exactly in alignment in the middle of the device. It's quite easy to get them to cross at the exit (one just drills the 45° hole using the nozzle flow hole

as a centre), but that leaks - the crossing point has to be in the middle.

The nozzle is rather longer than the standard no-valve one, and so it can get a little cold at the tip as all the heat has to be conducted down to it from the heater coil round the main barrel of the extruder. For the extruder using this new valve, I took an extra 2-ohm length of fibreglass-insulated nichrome heater wire, crimped a couple of connectors on the end, cut a short length of brass tube, and set the lot in more fire cement round the top of the valve nozzle. With a 6 ohm main heater in series, this puts 25% of the heat directly into the nozzle, keeping it nice and cosy.

Arc Compensation

Wednesday, 20th August 2008 by Adrian Bowyer

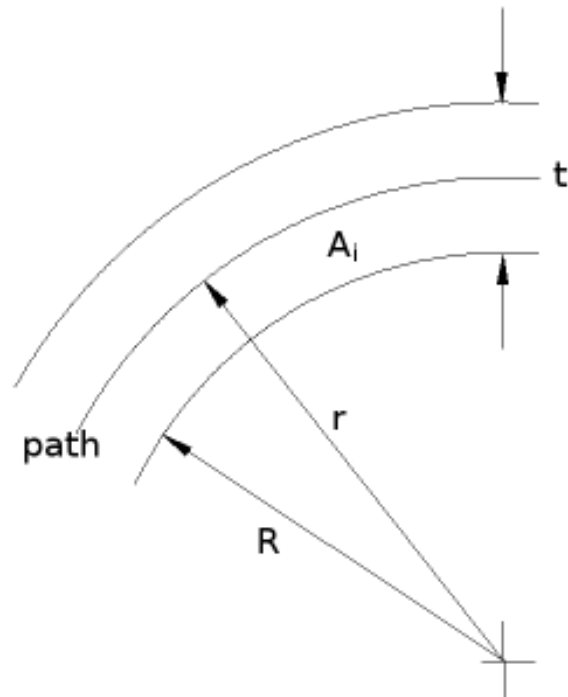

A few weeks ago Nophead pointed out that when the RepRap extruder moves round an arc it deposits too much material on the inside of a curve and not enough on the outside, owing to the differential in speeds caused by the slightly different radii. This is insignificant for large radii, but quite important for small ones.

I did the sums ([see this link](#)) and then put the compensation factor in the Java code, which is now checked into the repository. If you want to see how the code works, look at the `org.reprap.geometry.polygons.RrPolygon` class and see the function `arcCompensate`; the link gives the algebra, so I should start with that before looking at the code.

There are a couple of new parameters to control the behaviour (the default is not to do the compensation). The web page explains them too.

Going Round In Circles

Thursday, 21st August 2008 by Vik Olliver

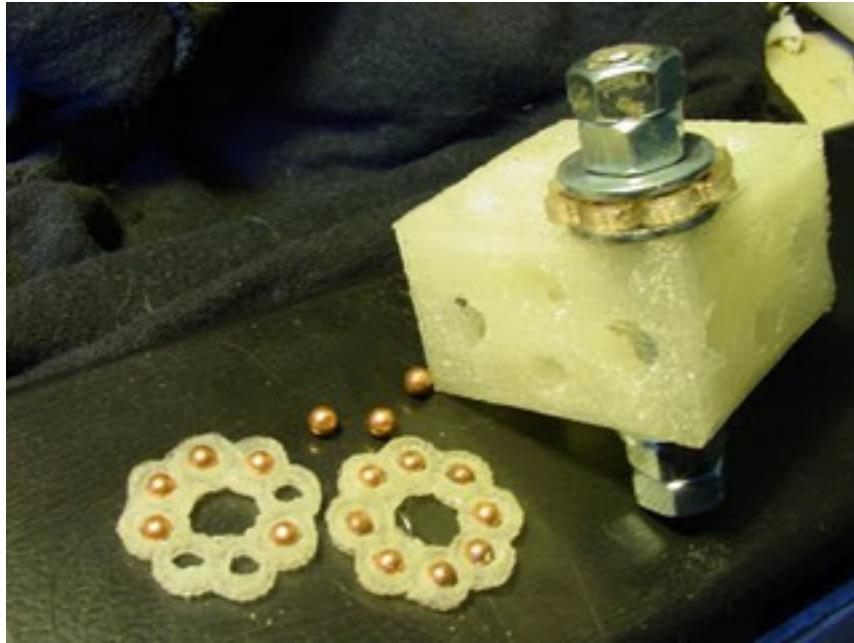

I took apart a swivel chair the other day and noticed an interesting ball bearing race in the bottom of it. So I made a RepRap'd version to fit under the Z axis drive rods, which currently sit on a couple of washers and some grease. Suz an I will hopefully fit them to Phoenix today, if we manage to get any time to ourselves.

On my machine it needs some tidy-up with a 5mm drill because I've not got the smooth-moving Arduino board installed on the Darwin yet. But once reamed out, the holes in the bearing race hold eight 4.5mm (.177) BB's normally used in an air pistol to plink at tin cans with in the garden.

It's sort of a compromise between running on bare plastic and using skate bearings - which cost me NZ\$6 a piece. BB's cost me less than a cent each and are also available from the same sporting goods stores as the skate bearings.

If they work well enough, I'll add them to the next run of the lasercut design. Ponoko's website tells me that the current one is 60% complete, so hopefully I'll see it early next week.

Vik :v)

New X Carriage Hot Off The RepRap

Thursday, 21st August 2008 by Vik Olliver



The Darwin has been busily churning out replacement parts for Phoenix, the rebuild of the original wrecked RRChild. The bed corner here is a standard support-free part, but the X Carriage has been modified to include an insert for all the places where the guide bars go through it. This fixes an issue whereby one of the holes (rightmost, in this picture) had a teardrop top in which the guide bar fitted very loosely.

The new carriage also features larger holes for the belts to pass through, which should allow some experimentation with fine-gauge ball-chain.

Vik :v)

RepRapped Screw Thread

Monday, 1st September 2008 by nophead

I needed something to pack part of my camera in to take it on holiday tomorrow, so I made a small pot with a screw top in HDPE: -



More details here hydraraptor.blogspot.com/2008/09/screw-top-pot.

Announcing ReplicatorG 0001

Wednesday, 3rd September 2008 by Zach Smith

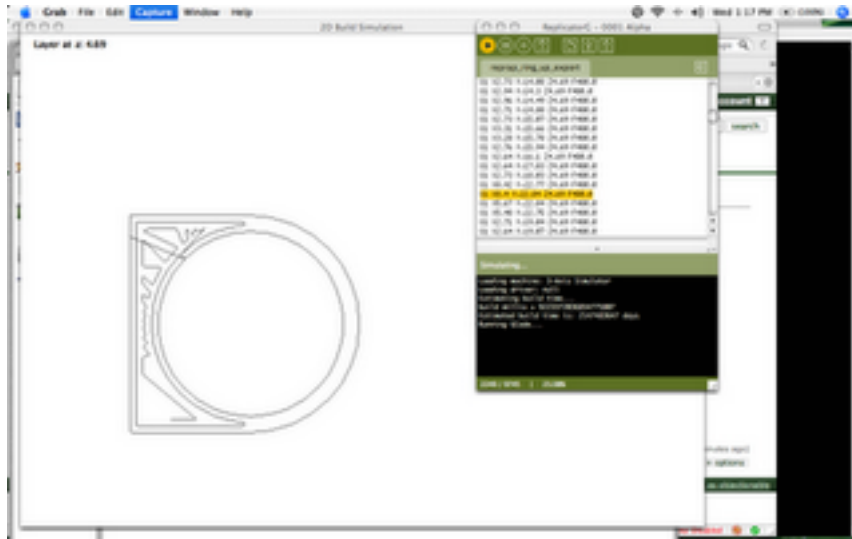

Hello All,

One of the many side projects I've been working on lately has now come to fruition! Its name is ReplicatorG, and it is an open source RepRap controller based around GCode. It is designed to solve many of the problems that I've run into when working with the current state of the art RepRap control software.

1. It is easy to install. Its forked from Arduino, so it comes with the simple installation.
2. It is easy to use. It comes with a gorgeous user interface, again courtesy of the Arduino project.
3. It is modular and expandable: It is built from the ground up with a Driver system to make adding support for new electronics systems and new protocols to be very simple.
4. It takes GCode as input, so you can use any one of the awesome GCode generators out there.
5. It is generalized, so you can use it for more than just RepRap: you could easily control a CNC machine with it.
6. It does one thing, and one thing only: control a RepRap machine. It doesn't try to do everything, and leaves the hard slice/dice work to smarter programs.

The first version is being released today, so please download it, give it a try, and let me know if you find any bugs. You can find out all sorts of into on the Replicat.org website.

Ball-chain for X axis

Friday, 5th September 2008 by Vik Olliver



This movie shows an X axis using ball-chain instead of drive belt. I built it on a design based heavily on Ian Adkins' lasercut RepRap, which I decided to attempt to simplify a little bit. As you can see, it appears to work. I'll do another run and tidy up the X axis - I just subverted part of Ian's design that looked handy.

One fly in the ointment is that I can't yet print the neat little lasercut toothed gears on my RepRap, though the new Arduino boards should help.

You can't see it here, but I had to elongate the holes for mounting the X motor into Ian's bracket. I'll do a quick redesign so that it can take the motor Ian is using and the ones I've got - plus anything between.

Vik :v)

All these parameters? WTF!?

Thursday, 11th September 2008 by Adrian Bowyer

There are, I will admit, quite a few parameters that the Java host software uses to control a RepRap machine when you select File -> Preferences...

I have (I hope) improved the documentation of these at:

<http://reprap.org/bin/view/Main/RepRapSoftwarePreferencesDocumentation>

Stripboard Sanguino

Thursday, 11th September 2008 by Adrian Bowyer

I have been asked to blog pictures of my stripboard version of Zach's Sanguino. Here goes:

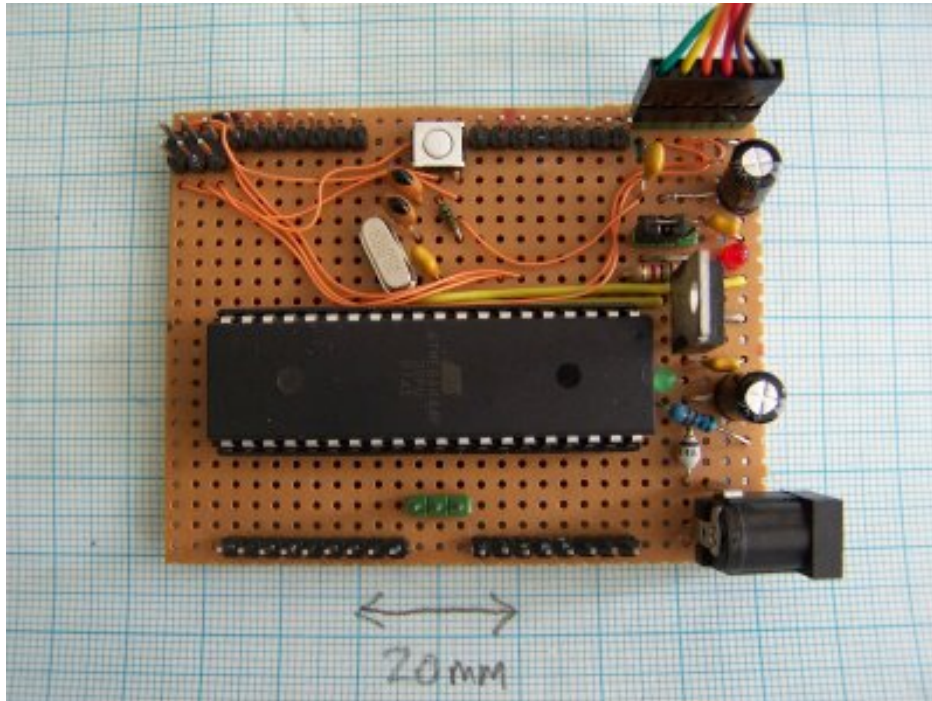

The cable top-right is the USB <-> TTL serial lead. The double-row 6-way connector top left is the ICSP connector, which you'll need to put the bootloader into the machine before you use the USB connection.

If you flip the board around a left-right axis in the middle of the above picture it looks like this:

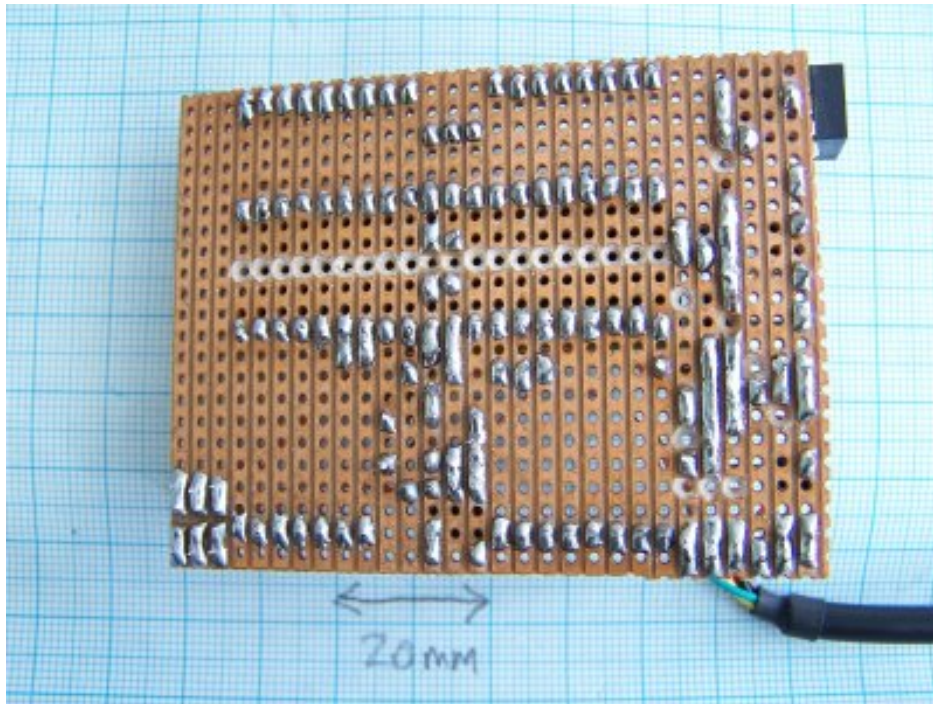

If someone has time (unlike me... sorry) to do a proper set of stripboard connection diagrams that'd be really helpful.

Off to Italy

Friday, 12th September 2008 by Adrian Bowyer



I'm off to CStem 2008 in Turin, who've kindly invited me to speak on RepRap. If you're in those parts next week, drop in!

They also wanted me to bring a working RepRap Darwin to demonstrate. What followed says something interesting about the cost of rapid prototyping. We looked into the amount we'd have to pay to transport the machine from Bath to Turin (it's not too heavy, but is bulky and delicate). It turned out to be both more expensive and more troublesome to do that than to buy and ship a RepRap electronics kit from the RRRF and a Bits From Bytes Silver RepStrap kit to Turin direct. So that's what we did. The CStem people have built and tested the electronics already, and are putting the laser-cut kit together as I type. When I arrive I'll help them with the last stages.

Mark you, last week we bought a whole working lathe for my University lab that cost less than a single RP polymer cartridge from a well-known RP machine manufacturer. How fortunate that it is possible to build all the RP parts of a RepRap machine from two such cartridges and still have quite a bit left...

Phoenix Gets A NEMA 17

Monday, 15th September 2008 by Vik Olliver

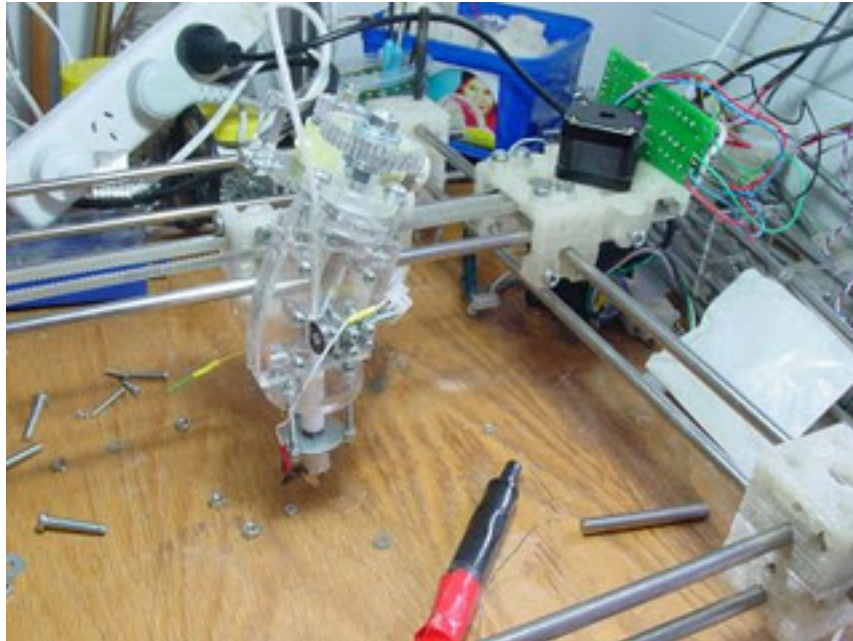

While reassembling rrChild into Phoenix, I fitted it with a NEMA 17 motor from Lin Engineering. These bolt on to the modified X carriage just fine and even fit the old belt gear moulds reasonably well. I wired up an Arduino driver and got it pulling a heavy acrylic extruder mechanism at just under 1A. The shaft is a little short, but things seem to run smoothly.

Also, I fitted new diagonal braces (the TSA killed most of the originals), using Ed's idea for a slotted diagonal bracket that needs no trapped nut or bolt. It simply used the M8 nuts to compress the bracket onto the 8mm rod. Works so far.

Oh, a Kiwi lasercut RepStrap is taking shape next to it. Hopefully using local suppliers where possible will reduce shipping costs for those in the Oceania region.

Vik :v)

Sanguino Software v1.1

Thursday, 18th September 2008 by Zach Smith

In tandem with the Arduino 0012 release today, I'm proud to release a new version of the Sanguino software as well! Its a pretty minor release, but here's whats new:

- * New and improved bootloader with 'Ladyada' mods contributed by Brian Riley
- * fixed bootloader path in boards.txt
- * added missing support for Serial.flush()

Also, I'm happy to say that you can now buy Sanguino kits from both the RepRap Research Foundation as well as Wulfden. Hopefully we'll have a European supplier soon.

Sanguino Software v1.2 Released

Friday, 26th September 2008 by Zach Smith

Just a quick bugfix release here. I fixed some bugs with the software that rendered it incompatible with Arduino 0012. Added some #ifdefs and brought in the new and improved timer code.

[Download it from Google Code.](#)

ps. If the Servo error bugs you, change line 43 in arduino-0012/hardware/libraries/Servo/Servo.c to:

```
#if (defined(__AVR_ATmega168__) || defined(__AVR_ATmega644P__))
```

New Board: Sanguino Breakout v1.0

Friday, 26th September 2008 by Zach Smith

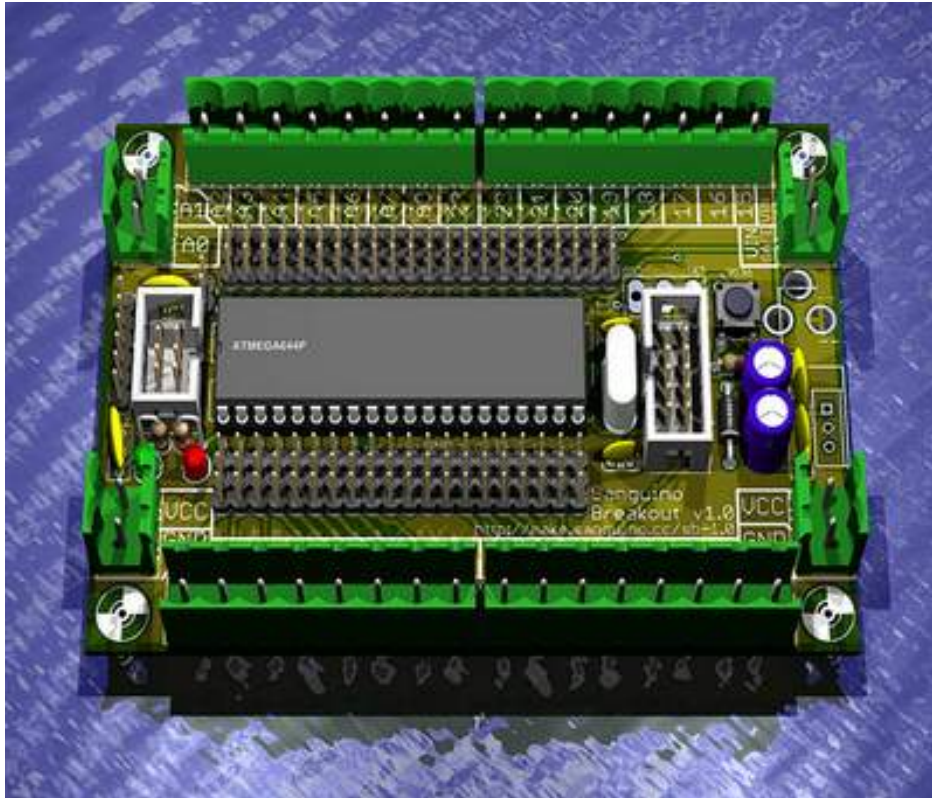

This is a breakout shield for the Sanguino. Similar to the Arduino Breakout Shield this board provides screw terminal access to all the pins on a Sanguino.

The board itself is designed for both new Sanguino users, as well as people with a pre-existing Sanguino. There is a full Sanguino footprint on the board. You can either populate all the components and have a single board, or you can populate only the pin headers + screw terminals and plug your Sanguino into the board. Since the space underneath the Sanguino is unused anyway, its like getting a free Sanguino!

Anyway, I sent it off to the board fab today, and will have boards back in about a week. They'll be available on the RRRF store, and kits will follow shortly.

Designs posted to Google Code.

New Board: GM3 Noise Suppressor v1.0

Friday, 26th September 2008 by Zach Smith

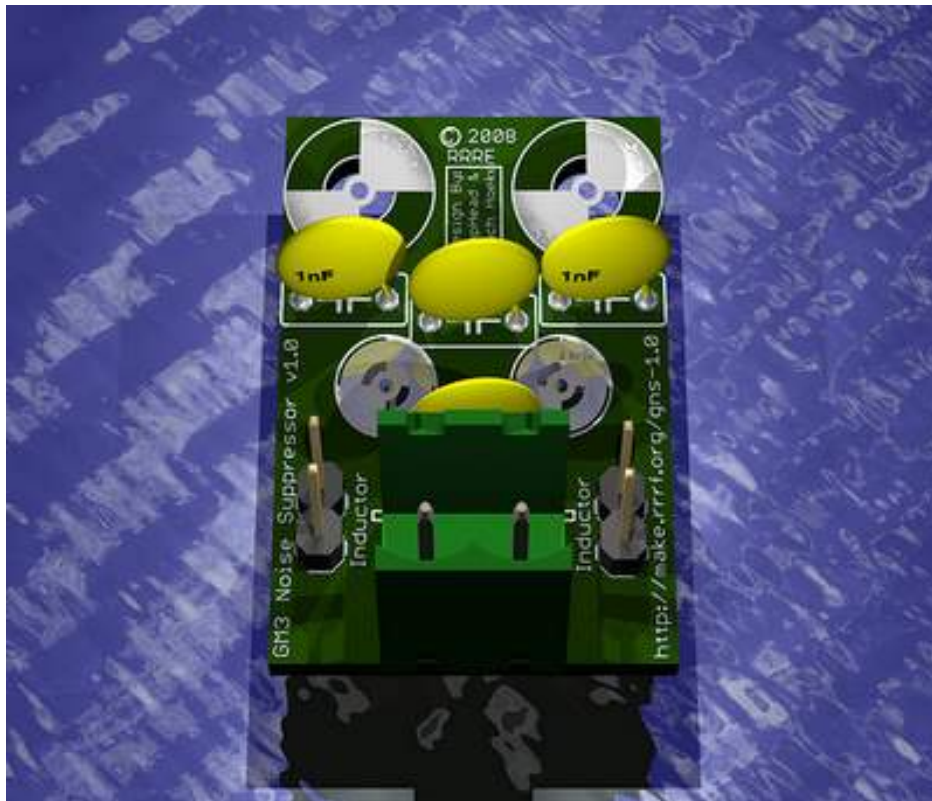

One of the things I'd like to improve upon is communicating what's happening in the project and new developments, even if they are not immediately available yet. So, today I'd like to announce a new board that we're sending off to the manufacturers: the GM3 Noise Suppressor.

The GM3 motor is our DC motor of choice for our extruders: it's small, fairly cheap, and fairly powerful. It also has dual outputs which is nice. Unfortunately it's also a cheap brushed DC motor that generates noise as it runs. One of our team members, Nophead solved this all the way back in October 2007. I'm just now getting around to making a board out of his circuit.

This board will do some cool things in addition to being a noise suppressor:

- * It will provide a secure place to attach wires to your motor (either via soldered wire + strain relief, or via screw terminals)
- * It will also provide support for the fragile metal tabs on the motor. (The board is intended to be zip-tied to the motor, then the tabs soldered.)
- * It will provide an easy way to mount/unmount the motor (via screw terminals)

Anyway, we should get prototypes back in 10 days, at which point they'll be available in the RRRF store, shortly followed by kits.

Cheers,

Zach

Update: board files released to SourceForge.

Sanguino RepRap

Saturday, 27th September 2008 by Adrian Bowyer

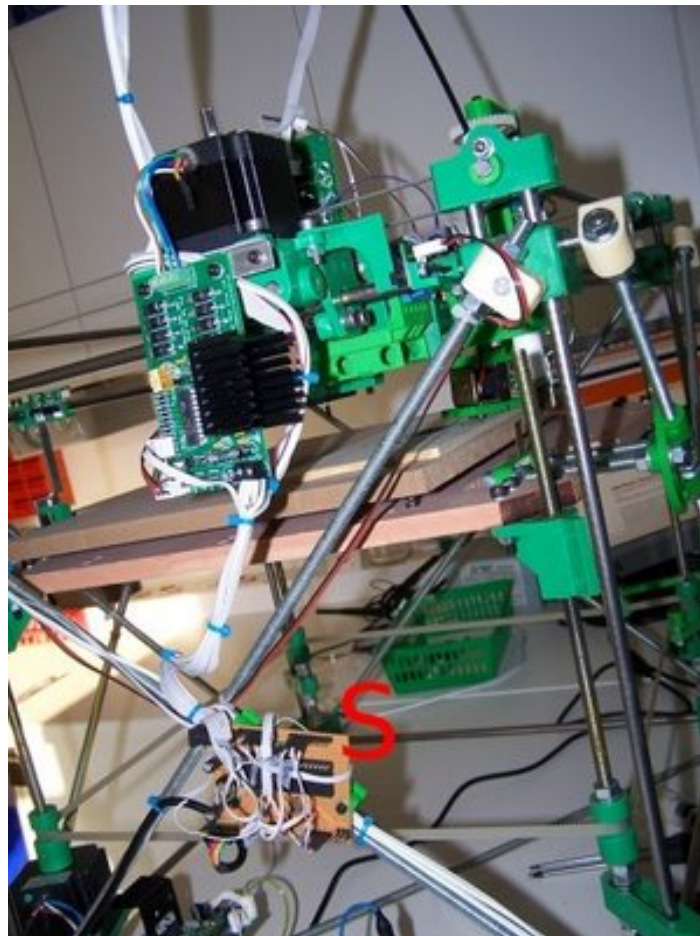

I stuck my stripboard Sanguino (red S) on my RepRap machine to see if it would fly. I want to do this so I can play with more than one extruder at once, for support material and so on.

Getting it to start working was pretty simple - I redefined the pins in `init.dist.h` for the Single Arduino Snap code, and the RepRap Java software started talking to it straight away.

With a bit of messing about I got the axes moving, then - when I put the wires on the pins I'd actually defined in the header file - the zero opto-sensors worked too.

But I got a lot of comms errors. These were much reduced by adding:

```
for(int i = 1; i < 32; i++)  
{  
  pinMode(i, OUTPUT);  
  digitalWrite(i, LOW);  
}
```

}

to the initialisation code, then letting the classes set the pins they actually use as they want. (Incidentally, the Arduino code doesn't do this for all the pins it uses - maybe it should...)

I suspect we have some stray interrupts from somewhere (like noise on unconnected pins), and also some code in there that switches off interrupts for too long, and so it loses bytes from the input stream.

The comms errors are still too bad to make the extruder go properly, though the temperatures are being measured fine.

If you want to play it's all at:

<http://reprap.svn.sourceforge.net/viewvc/reprap/trunk/reprap/firmware/Sanguino/>

The pin assignments are in the OpenOffice spreadsheet [here](#).

Tomorrow, if I have time, I'll see if Zach's upgrade just below cures some of the problems...

Ponoko Lasercut Prototype Strike 3

Monday, 29th September 2008 by Vik Olliver



The Ponoko-inspired lasercut RepRap is now hopefully in its final iteration. I've built most bits at least twice, and I have tried to remain compatible with Ian Adkins' lasercut RepRap at BitsFromBytes as well as the original Darwin. I've taken the best from both in true Open Source manner, so we have:

- No routing needed. No hand-tooling of any of the plastic bits, in fact (if I've got it all right).
- The extruder is now swappable and is compatible with the Darwin swap design (if I've got the measurements right on this one too).
- I have put 2 extruder mechanisms on the sheets so you have something to change.
- The Z motor can be replaced by a GM3-type gear motor and rotary encoder. I've made the Z motor bracket so it can use opto sensors and a variety of other gear motors too.
- There is now a capstan that can be fitted to the top of one of the Z driver rods. This can be moved by the head, allowing the carriage to move the Z platform up and down at <0.1mm>
- The DIY bearing races have been put in. You can still use the skate bearings if preferred.
- Ball-chain is used in place of all belts. The larger 4.5mm chain (either of 2 variants) is used for the Z axis, X and Y can use either 3.3 or 3.5mm ball chain.
- X & Y axes can be fitted with NEMA17 steppers.
- The Y opto flag can be placed on either side of the X carriage so we remain compatible with Ian's design.
- The X carriage may be removed without disassembling the carefully-aligned frame.

- The corner bracket parts that Ian reported his clients broke a lot are now cut from 8mm acrylic instead of 4.5mm - and I've included a spare.

Just submitting them for the Final Cut (thank you Pink Floyd).

Vik :v)

Meshlab

Monday, 29th September 2008 by Forrest Higgs

In which your narrator, unable to find the "simplify mesh" command in a newly downloaded copy of Art of Illusion rashly asks the rest of the core Reprap team where it is to be found these days...

Since getting the positioning robot of Tommelise 2 running properly some time ago, I've spent most of my time milling plastic and steel. Doing that quickly revealed the lamentable state of my PC-side Slice and Dice software which means that for every hour I've spent milling this or that I've spent 4-5 hours sorting out problems in Slice and Dice.

The slicing module started out being reasonably stable, if a bit slow. Most of the development action has been happening in the dicing routines. Efficient milling of objects requires that Slice and Dice do things that aren't necessary for additive extrusion like FFF.

Last night, I pretty much got everything running using my usual software development paradigm, viz, writing a horrifyingly complex piece of code (not necessarily the same thing as a BIG piece of code) and spending weeks getting it running properly only to realise that there is a much simpler way of doing the job. The code in question was one which collected and linked together minute line segments generated by my grid approach to dicing. About dark on Sunday, I realized that a simple agent routine could probably do the dicing job that I'd been struggling to make work. Three hours later, the agent was written, tested and commissioned in Slice and Dice.

In testing the agent module, I began to run up against an Art of Illusion-related problem. While Aol does a fair job of converting solids descriptions to STLs it does tend to rather proliferate surface meshes. A small, 40-toothed involute profile gear that I'd designed required about 175,000 mesh triangles to describe it. Much of this complexity comes as a result of doing the #D boolean operations needed to convert a gear profile into a solid object description.

There used to be and may still be, for all I know, a command in Aol called "simplify mesh" which could greatly reduce the complexity of such Aol surface meshes. Unfortunately, I've been working on the positioning robot for Tommelise 2.0 for a long, long time and had bought a new PC during that time. As a result, I'd not run Aol and had got quite rusty with its use. When I downloaded and installed the latest version. That's when I got rash and put out a RFI to the core Reprap team asking for assistance in finding the "simplify mesh" command in the newest Aol release.

Vik, ever helpful, responded within a few hours that I ought to take a look at a new open-source package that he'd discovered the previous week called Meshlab. I quickly downloaded and installed Meshlab and had a go with it. I'd hoped for a simple routine that simply ate big STL files and spit out smaller, more efficient ones. When I imported my 40-toothed gear milling project into Meshlab, I realised that I'd got considerably more than that.

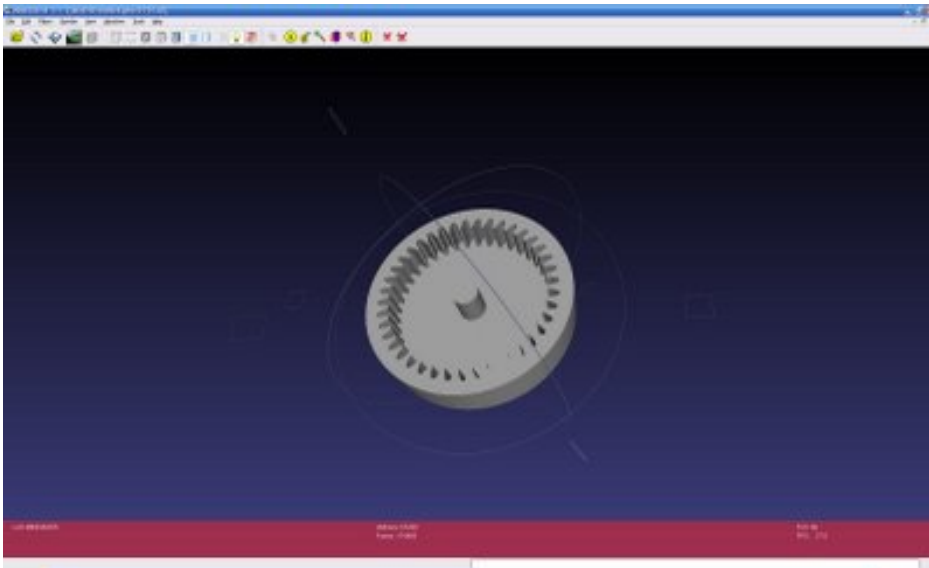

Following Vik's instructions I was able to reduce the complexity of the mesh described in my STL file by an apparent 75%, judging from the file size. When I tried to open this simplified STL file in Slice and Dice, the input routine crashed. I quickly discovered that whereas my Slice and Dice routine required that STL files be expressed in ASCII format, Meshlab spit them out in binary format. Finding no way to change settings in Meshlab to export ASCII format STL files, which is not the same thing as saying there are none, I solved the problem by re-importing the simplified STL file into Aol and then saving it again in ASCII format.

That done, I discovered that Meshlab had reduced the complexity of my original mesh by 50% instead of the 75% that I'd originally thought it had.

While poking around looking for an option in Meshlab to save STL files in ASCII format I noticed a little button consisting of a cylinder with a number of planes cutting through it.

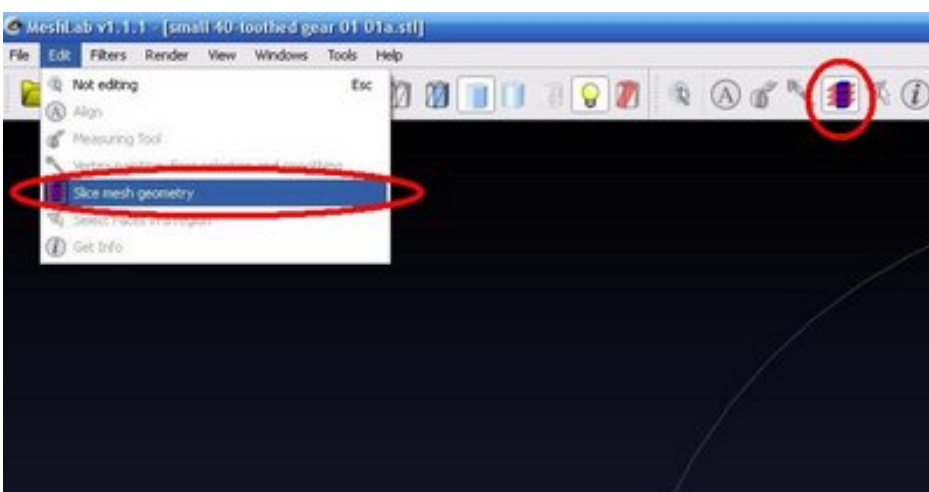

This command had the intriguing name of "slice mesh geometry". Clicking on it just for fun cut a plane through my gear project.

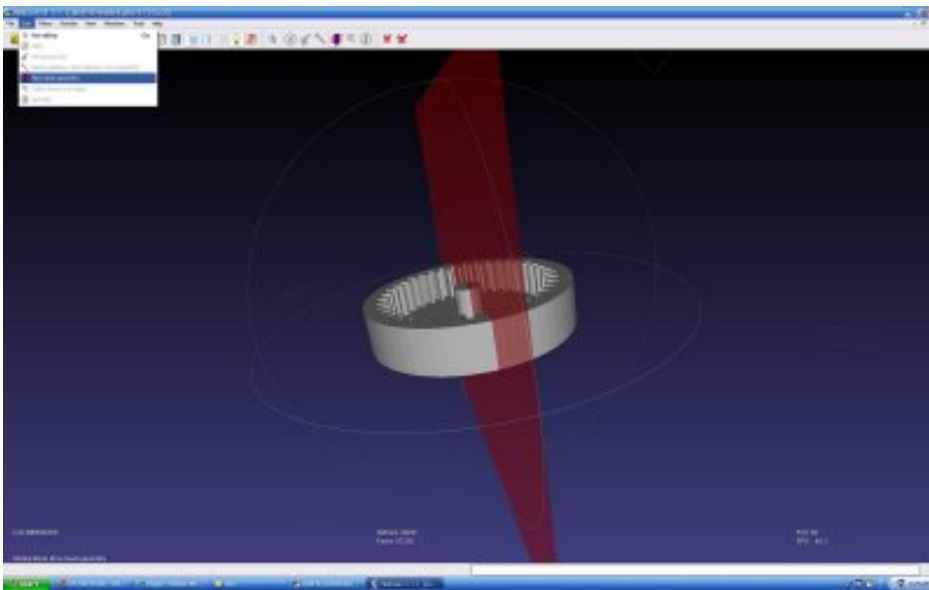

I quickly discovered that this cutting plane could be oriented and specified in some extremely interesting ways.

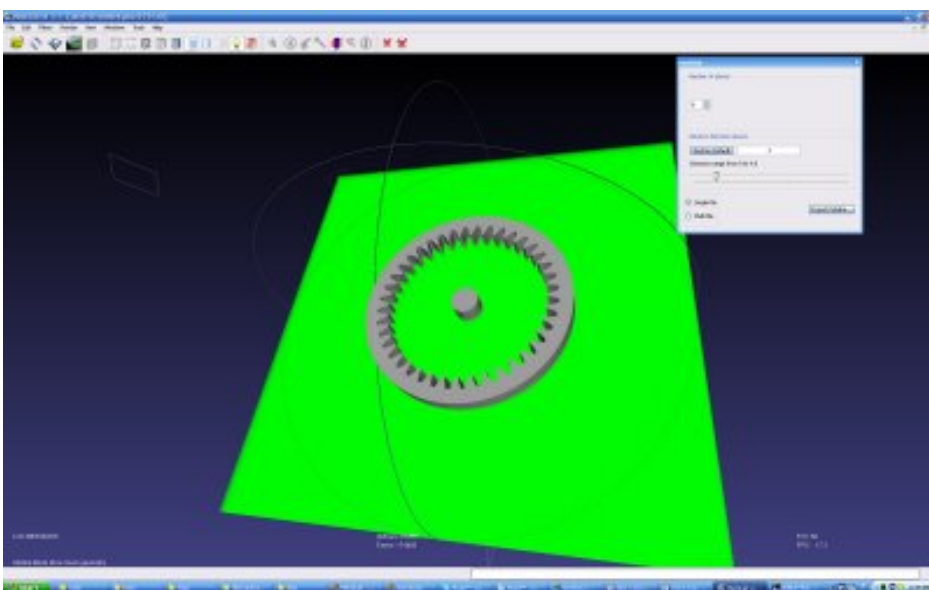

A small window popped up that allowed me not only to cut my object with a plane, but instead let me slice it with a set of parallel planes set at standard distances from one another which could be easily set. Not only that, it allowed me to save the resulting information in SVG (Scalable Vector Graphics) format, a variety of XML.

```
11:00 num:0 </text>
  <g stroke='black' stroke-linecap='round' >
<svg id = ' 1 ' >
<rect width = '1000' height = '1000' x='1000' y=' 0' style = ' stroke-width:1; fill-opacity:0.0; stroke:rgb(0,0,0)' />
<line x1='1401.500529' y1='50.743513' x2='1396.371970' y2='52.100632'
stroke-width = '2' />
<line x1='1396.371970' y1='52.100632' x2='1354.071654' y2='63.001501'
stroke-width = '2' />
<line x1='1445.501315' y1='43.519401' x2='1401.500529' y2='50.743513'
stroke-width = '2' />
<line x1='1450.042963' y1='42.700302' x2='1445.501315' y2='43.519401'
stroke-width = '2' />
<line x1='1494.040792' y1='40.233665' x2='1450.042963' y2='42.700302'
stroke-width = '2' />
<line x1='1490.949170' y1='40.000000' x2='1494.040792' y2='40.233665'
stroke-width = '2' />
<line x1='1547.095020' y1='42.410059' x2='1543.717939' y2='47.204292'
stroke-width = '2' />
<line x1='1543.717939' y1='42.204292' x2='1490.949170' y2='40.000000'
stroke-width = '2' />
<line x1='1596.349742' y1='49.995059' x2='1591.603042' y2='49.244664'
stroke-width = '2' />
<line x1='1591.603042' y1='49.244664' x2='1547.095020' y2='42.410059'
stroke-width = '2' />
<line x1='1643.044461' y1='42.601962' x2='1630.345020' y2='61.207690'
stroke-width = '2' />
<line x1='1630.345020' y1='61.207690' x2='1596.349742' y2='49.995059'
stroke-width = '2' />
<line x1='1347.724426' y1='46.201901' x2='1307.950200' y2='41.024503'
stroke-width = '2' />
<line x1='1354.071654' y1='43.001501' x2='1347.724426' y2='46.201901'
stroke-width = '2' />
<line x1='1409.940091' y1='40.348500' x2='1403.315350' y2='37.792613'
stroke-width = '2' />
<line x1='1403.315350' y1='37.792613' x2='1443.044461' y2='42.601962'
stroke-width = '2' />
<line x1='1307.950200' y1='41.024503' x2='1300.104444' y2='45.026270'
stroke-width = '2' />
<line x1='1300.104444' y1='45.026270' x2='1263.600364' y2='104.642954'
stroke-width = '2' />
<line x1='1726.244236' y1='90.751163' x2='1409.940091' y2='40.348500'
stroke-width = '2' />
<line x1='1714.209951' y1='102.024702' x2='1726.244236' y2='90.751163' />
</g>
</svg>
</text>
```

The biggest shock was the speed with which it could do this slicing. I'd been rather proud that my Slice routine could cut a slice something of the complexity of my gear project in a matter of a couple of minutes. Imagine my mortification when Meshlab did a dozen slices of the same project in the blink of an eye. Reading a bit more about the Meshlab project, they have some 32 programmers working on the code. From the looks of things they're also quite good programmers who know their geometry.

While I tend to trust my own coding, largely because if I need it to do something special I can get in and alter it to do that something special with relative ease, I know when I'm beaten. If the slicing routine in Meshlab is doing what it appears to be doing, I'm retiring by slice module and using Meshlab instead.

Meshlab Discovery - The Origins

Tuesday, 30th September 2008 by Vik Olliver



The Meshlab utility I recommended to Forrest was something that I'd hunted down while trying to find a PLY to STL file converter that was Open Source. I was trying to import free animal models in to the RepRap GUI to see how the RepRap did at sculpture, and to show off at the New Zealand Open Source Awards. In the end I found this cat, but it had eye-holes and the base was open. Fortunately Meshlab has a very intelligent filter for closing holes that creates Euler-valid solids (unlike the "close boundary" option on ArtOfIllusion).

As you can see, the RepRap (a standard Darwin extruding PLA) did a fair job of the cat, and that's at a resolution of 2,000 facets. Note also that it did a very nice job of the cat's chin, even though that was overhanging by considerably more than 45 degrees!

Vik :v)

RepRap Builder's Wiki

Wednesday, 1st October 2008 by Adrian Bowyer

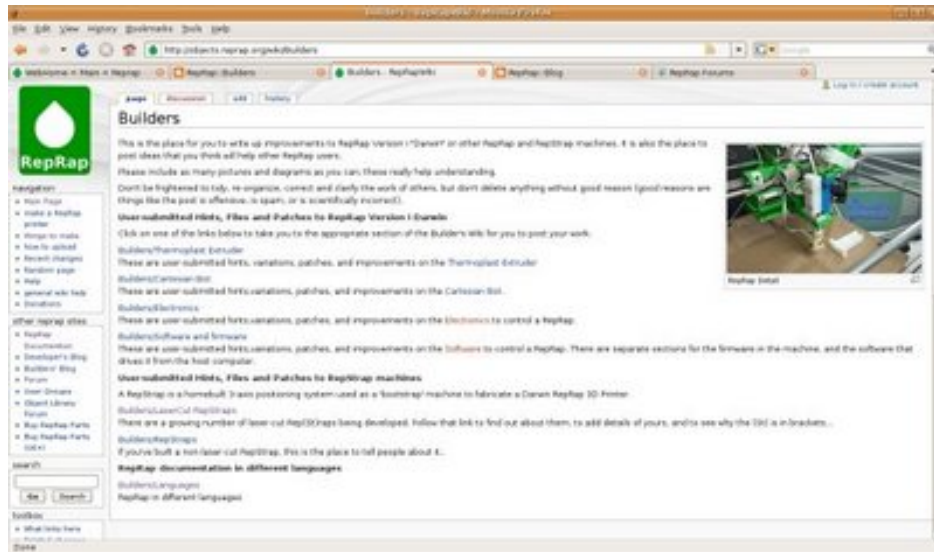

Today we launch the RepRap Builder's Wiki. Here anyone can post any RepRap information that will be helpful to the RepRap community.

Don't be frightened to tidy, to re-organize, to correct and to clarify the work of others, but don't delete anything without good reason (good reasons are things like the post is offensive, is spam, or is scientifically incorrect).

By all means include lasting information that has previously appeared in the Main Blog, the Builder's Blog or the Forums - we want to systematize that in a chronologically-independent way on the Builder's Wiki. But please don't post questions (they belong on the Forums) or information that is transient. Indeed, if all you do is to take some nugget from one of those sources that you personally have found useful and post it on the new Wiki, you will be doing everyone else a great service.

If you post, please include as many pictures and diagrams as you can; these really help understanding. Remember that you can freely copy any images and text from any other part of the RepRap website - it's all covered by the GPL.

Belts anyone?

Wednesday, 1st October 2008 by Forrest Higgs

In which your narrator makes a serendipitous discovery that may well impact replicating one of Darwin's critical parts while cleaning up Tommelise...

While cleaning up the plastic swarf from last night's gear making exercise, I had a close look at the scrap that was left between the gear proper and the cylindrical boundary of the milling exercise.



That was the point where serendipity kicked in. Those specific scraps looked pretty much exactly like a few teeth from a ruined automotive belt.

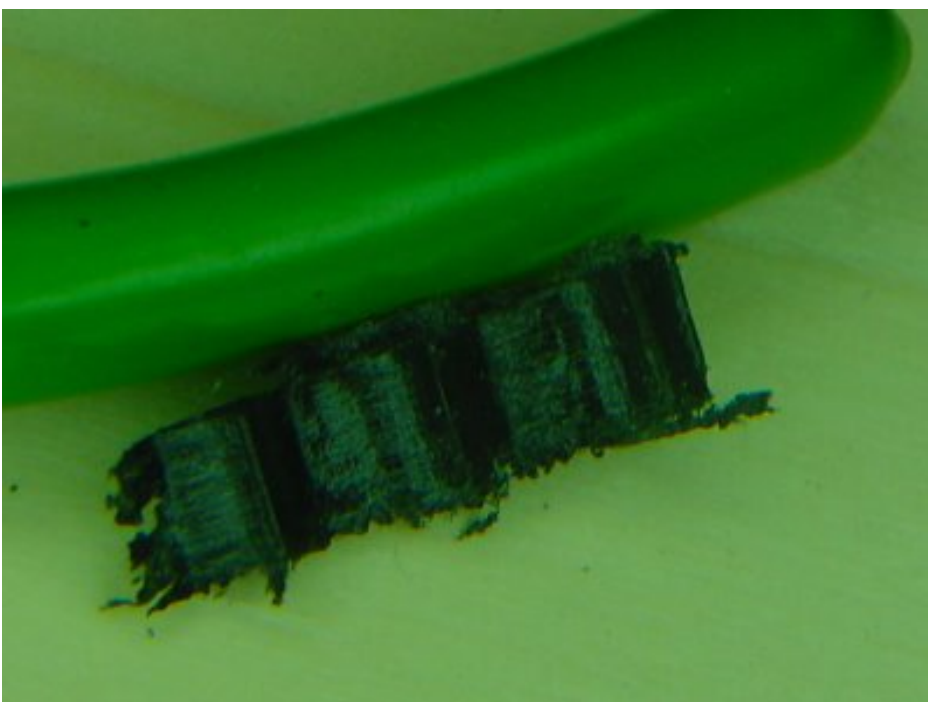

Not only that, they were flexible like the drive belt from a ink jet printer, albeit at rather a larger scale and tough as well.

What would happen if I set out to deliberately mill a drive belt out of sheet plastic like HDPE or HPP in a closed loop serpentine configuration that would allow me to make a continuous belt many times longer than the dimensions of the sheet of plastic I milled it from? Darwin would require one less very important "vitamin" , to use Adrian's happy term.

Thinking a bit further, there is no reason whatsoever why such a belt could not be similarly extruded as a single extrusion width, closed loop serpentine using the extruder tool head, either.

For my own more practical purposes, I can see one-piece treads for small robots being made by either of these methods.

Testing the envelope

Wednesday, 1st October 2008 by Forrest Higgs

Well, it's been about eighteen months since hitting a milestone on my Reprap work has caused me to to break out my 12 year-old Mcallans' single malt. Tonight... is the night, though. I should possibly have published this in the Builders' blog. I reasoned that you could do this with a Darwin, however, so I published it here in the main blog instead.

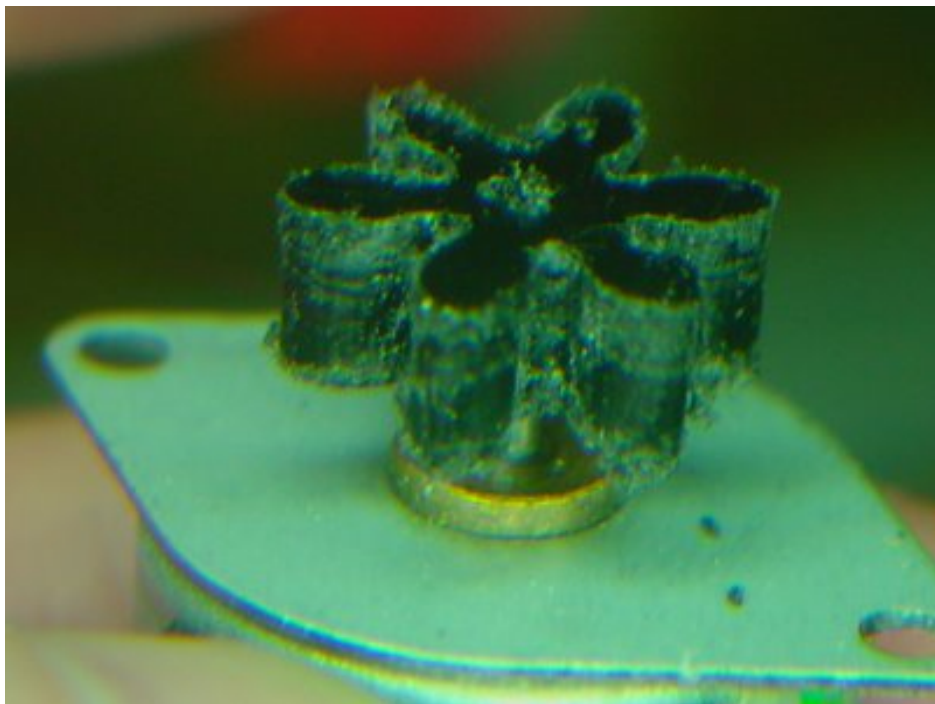

What you are looking at is a six-toothed involute profile sprocket gear cut on Tommelise 2.0. It has a pitch radius of 6 mm, a pressure angle of 20 degrees and with its involute profile surface defined by six planes. I cut it with a 1/16th inch cutter mounted in a flexible drive shaft on a standard Dremel hand tool mounted to Tommelise 2.0's positioning robot. It was cut in commercial 1/4th inch black, HDPE sheet. This sprocket is probably smaller than it needed to be.

I wanted, however, to test the envelopes of my Slice and Dice software, the cutter and the positioning accuracy of the Tommelise positioning robot. I could probably get eight teeth on a 6 mm pitch radius gear, but that would be right at the limits of my system.

It took me about two and one-half hours to cut it. Most of that time was spent worrying that I'd mar the piece. It should go quite a bit faster in future now that I have the parameters for working HDPE on this machine.

I developed the gear profile using a script that I wrote in Java two years ago as an add-on for the Art of Illusion 3D modeling system. Testing out the profile on a poplar blank went on yesterday

after what seemed like a lifetime of tweaking my Slice and Dice routine to do milling work instead of additive extrusion. You can see the relative size of this sprocket gear with respect to the original ten-toothed prototype that I cut some weeks ago.



Yesterday, however, everything seemed to come together and this morning during a break from my day job I found the final bug in the routine that turns the XML description of the gear into print instructions that are sent over the PC/Tommelise USB link and burned on the EEPROM print buffer.

My first attempt to cut this sprocket was tried with a sheet of 1/4th inch polypropylene. The handling of this material, however, proved to be tremendously different than HDPE, so after work I decided to do a trial cut in HDPE, a material I've had some prior experience with, instead.

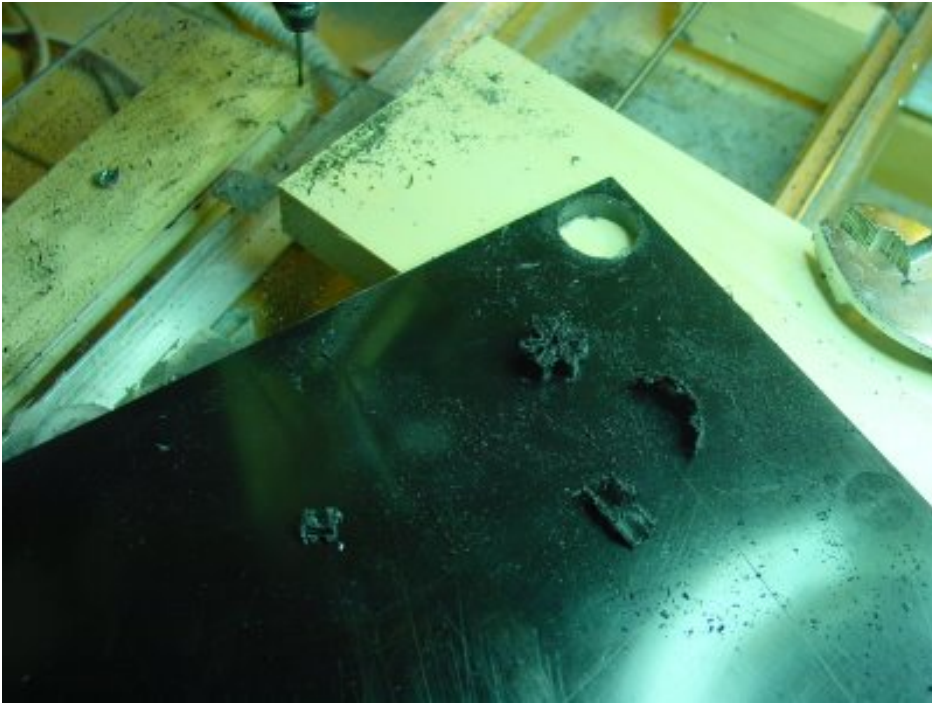

The gear broke loose from the sheet quite abruptly and caused me quite a fright. I feared that the cutter would damage the sprocket. Nothing of the sort happened, however.

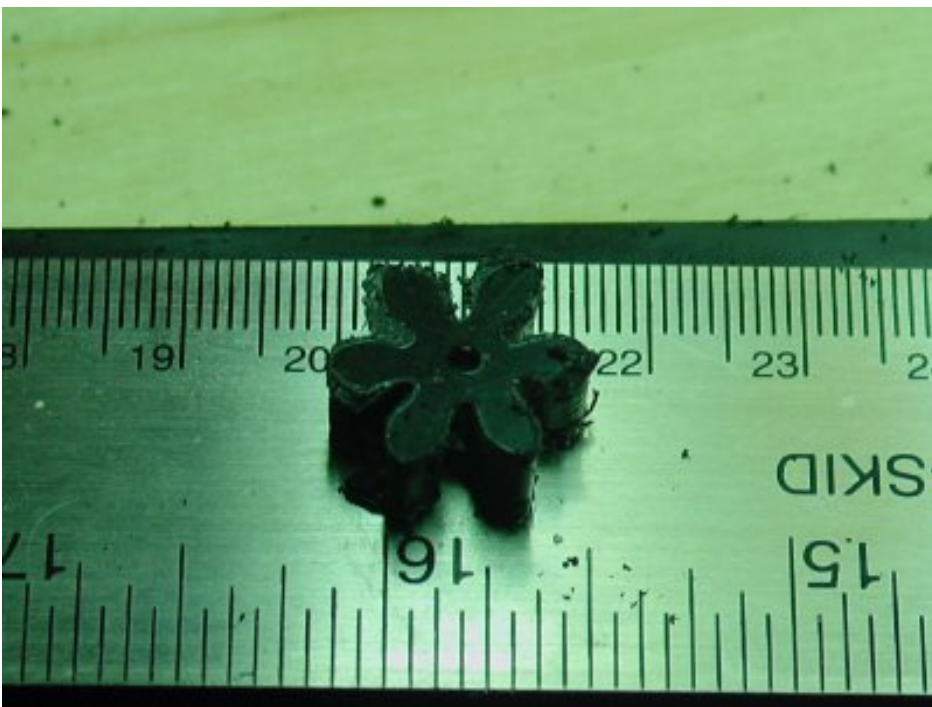

Here, you can see the scale of the sprocket. I designed the gear to have a precut hole that would give me a good friction fit on one of my little tin can stepper motors. The sprocket looks a little fuzzy because I didn't have any fine grit sandpaper to clean the swarf off with. Knocking off the swarf was a matter of a minute or so with a fine screwdriver and a loose cutter.

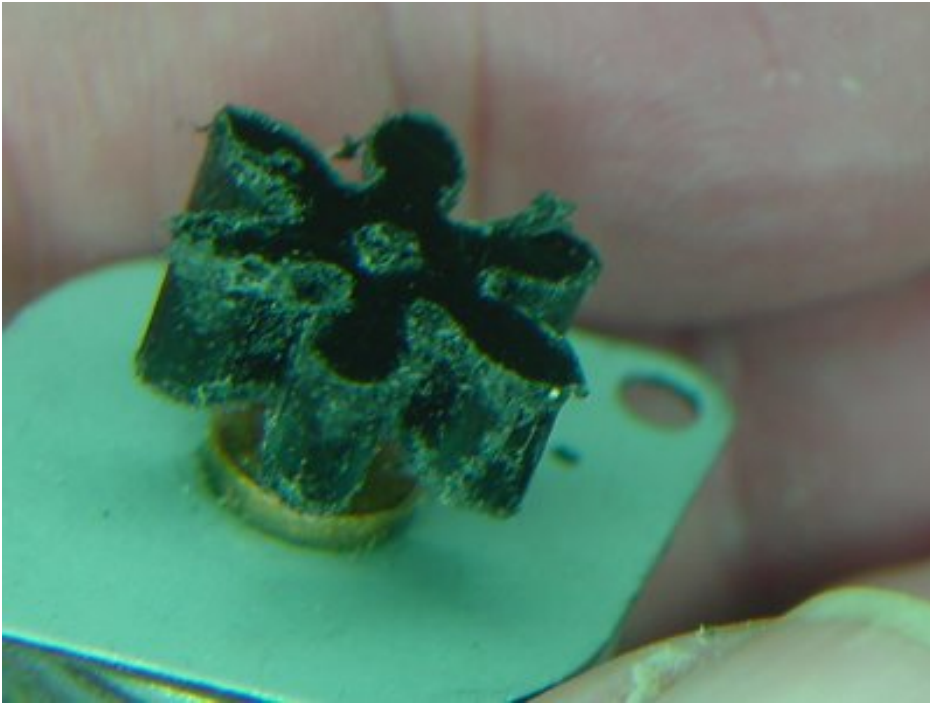

It needs saying that this sprocket is only sort of a demonstration piece. I've actually designed it as part of a fist-sized alti-azimuth positioning system for an infrared radar environmental mapping system that I'm building for a mobile robot project that I began recently. That project is most definitely not open source so you'll not hear it mentioned again for some time, if ever. Tommelise is getting put to very practical work from the get-go.

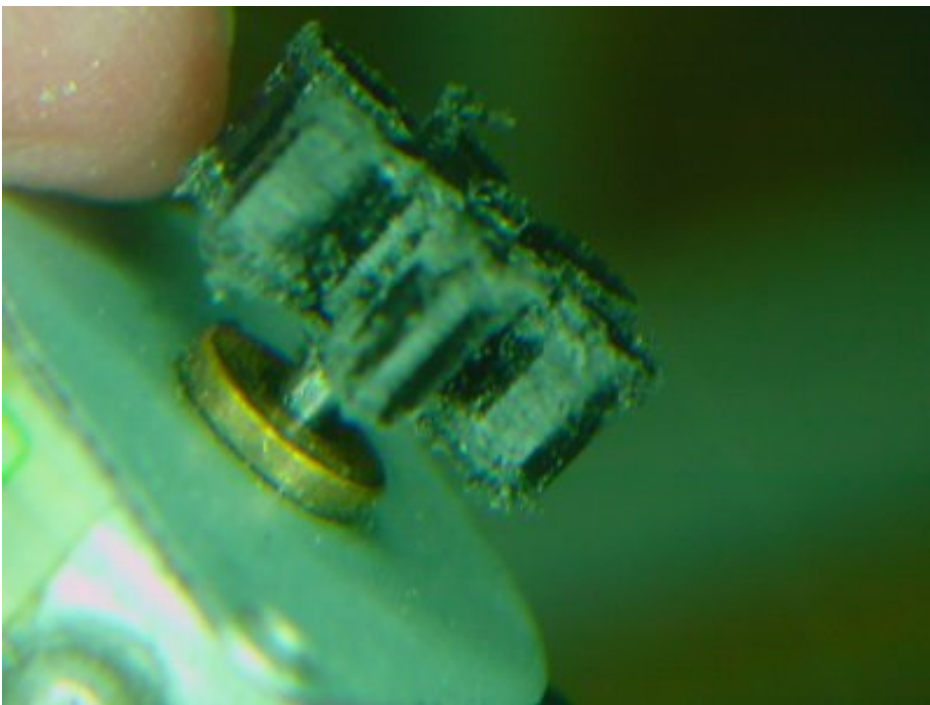

Here you can get an idea of how cleanly the walls of the sprocket have been cut. Now that I know how to cut steel and can cut spools for the electromagnets for my linear stepper motor project, which most definitely will be open source, I expect to start making rapid progress on that development shortly.

New Board: Stepper Motor Driver v1.2

Friday, 3rd October 2008 by Zach Smith

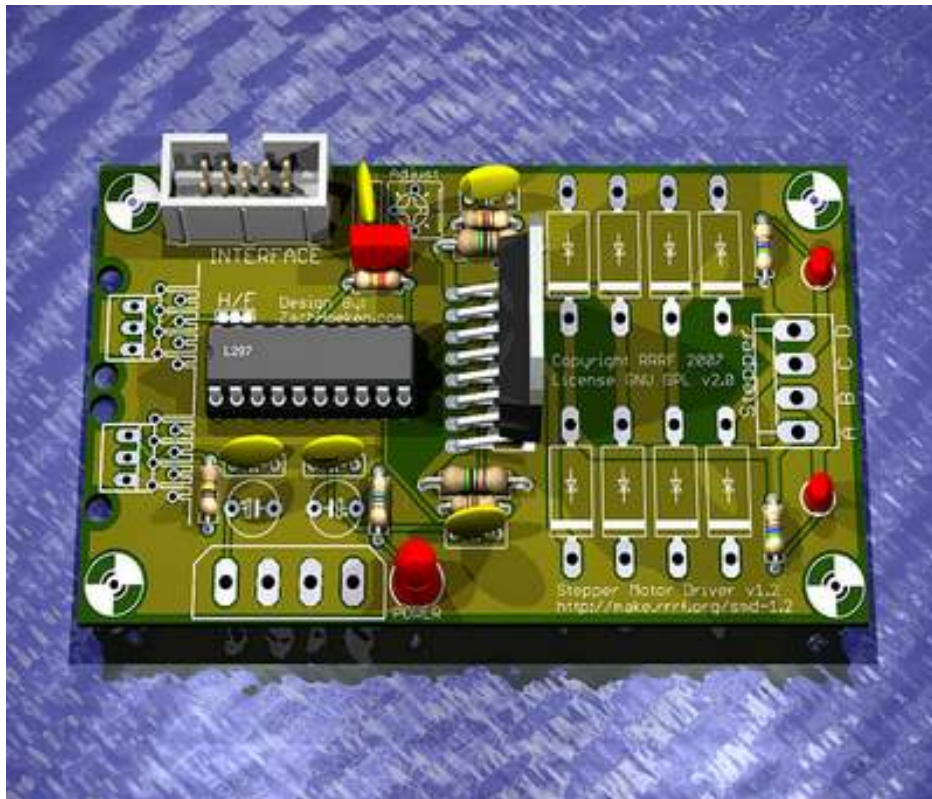

I sent a new board off to production earlier this week, the Stepper Motor Driver v1.2. This board is a minor upgrade from the previous Stepper Motor Driver v1.1 board. It still uses the same L297/L298 chipset (all through-hole!) but I've modified it a bit:

- * added 10-pin IDC header for interface
- * simplified unique component count
- * removed a couple unnecessary components
- * re-laid out the board to route better
- * added RJ-45 footprints w/ optional .100" header

I've also been working on the Generation 3 electronics for a while now. One of the things I'm aiming to achieve is making everything a bit more friendly to assemble. One of those things is the switch to using IDC connectors where possible. These things are super easy to make, polarized, and fairly cheap. I'll be coming out with a 'Sanguino Motherboard' soon which will have complementary IDC headers. Wiring up your RepRap will be *much* simpler with these new electronics.

Of course, you can easily just have an IDC connector on one end and route the individual wires to where you want.

Files posted to SourceForge or available in SUBversion as always.

Wahooo!!

Friday, 3rd October 2008 by Zach Smith

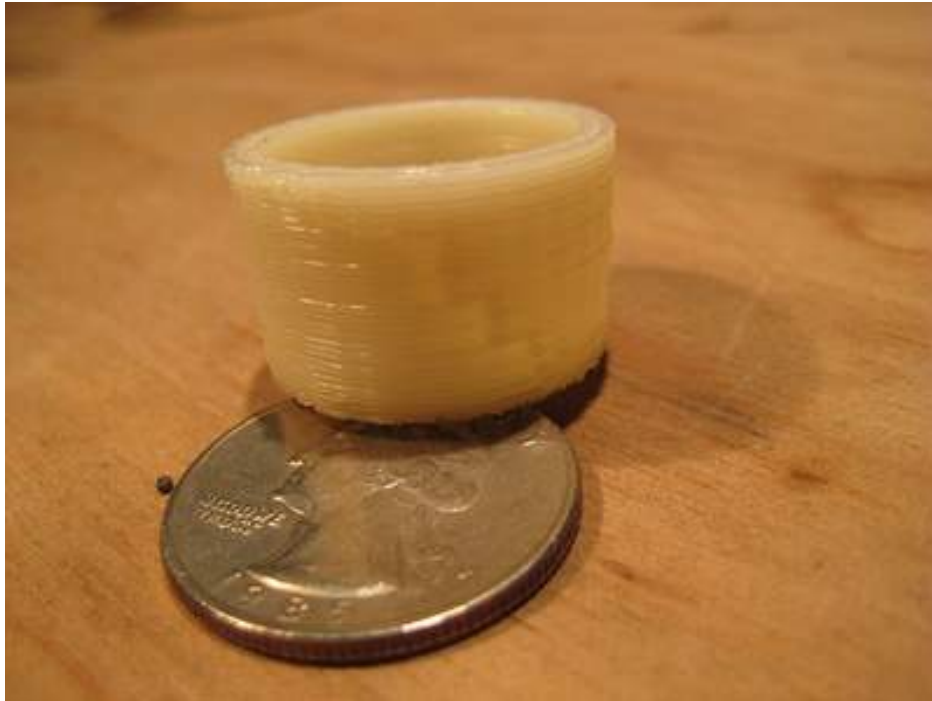

Well, I finally did it: I've printed my first minimug. This may come as a surprise, but the Director of the RepRap Research Foundation has never printed anything, UNTIL NOW! (Hey, I never said I was *good* at this stuff, just that I love working with it.)

I'm really excited about how this build turned out. Here's my current setup:

3-axis system: Darwin

Extruder: Lasercut Extruder (variant on BitsFromBytes.com design)

Electronics: Arduino + rotary encoder

Firmware: GCode Interpreter

Slice/Dice: Skeinforge

Control Software: ReplicatorG

I'd like to take this opportunity to reflect on the past few years of work (wow!) and say that I've thoroughly enjoyed working on the project and I look forward to working on it even harder in the coming years.

When I first started working on RepRap, I was a wild-eyed college student with dreams of 3D printers and being able to whip together a 3D printer in a few days and start changing the world.

Of course a few days turned into weeks, which turned into months, which turned into years. I've learned a *ton* along the way though and have had my share of mis-steps as well. I've come from

basically zero understanding about electronics, firmware, microcontrollers, extruders, and cartesian robots to a point where I am reasonably comfortable with all of those technologies and am now active in developing and hacking on the next generation designs.

We've come a long way as a project from the early days, and luckily things have only changed for the better. For example, when I first got started, the first thing I did was build the electronics. Except there were no manufactured boards. Adrian had but up a little how-to on the website about how to etch your own boards. I decided that this was way too hard for myself (and by extension, your average person) so I decided that I would get them manufactured. Thus the RepRap Research Foundation was born. Since then, nearly every single part you need to build a RepRap is now available from either the RepRap Research Foundation, or BitsFromBytes.

I'm not sure where I'm going with this, but I'm excited about the future of this project. Now that I have these physical objects in front of me that my machine produced, it feels so much more real. No longer is the printer this magical dream that I've been chasing for so long, but it is something that I have sitting in front of me. There are many things to be improved, and there are many things to be changed, but it works, and that's good enough for now.

For all those out there who are just following along, or are struggling with building your own machine: keep up the fight, and keep hacking on it. You'll have your machine working and when you do it will be beautiful.

Cheers,
Zach 'Hoeken' Smith

Building ABS on a lasercut/fabbed Darwin

Saturday, 4th October 2008 by Vik Olliver

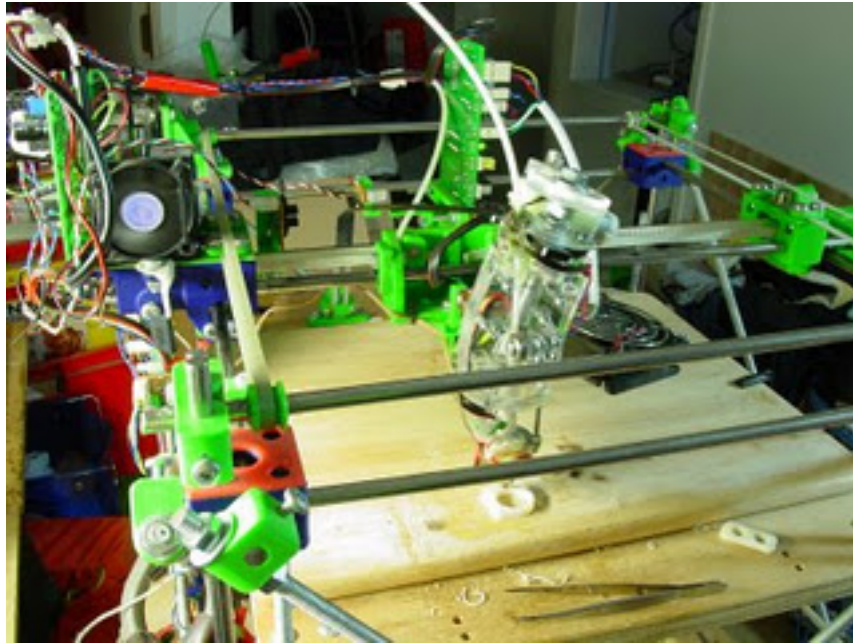

I've managed to put together one extruder from the bits of lasercut prototypes Ponko have been cutting for me. It slotted straight in to the Darwin head exchange mechanism, but was a bit loose. I've got a better extruder base already being cut by Ponoko so I was expecting that and simply wrapped it with tape. The extruder motor is a little far away, so a temporary heave-to has been executed with a cable tie. Sorry, ugly. Is also fixed already.

I've loaded it with ABS and am now printing components with it, as you can see in the photo, as well as a classic Mighty RepRap Power Ring. I've fitted the ABS extruder to a Darwin to try my hand at testing out ABS, Imagin Plastics were kind enough to give me a 50m sample of 3mm ABS natural. Looks good, and I should be able to get it for under NZ\$20 per 100 metre coil.

I've found ABS to be generally the hardest plastic to work with. It needs high temperatures, high pressures, and isn't that keen to laminate. You have to work in thin layers to keep lamination, which slows me down. It does score on accuracy and tidiness, however, as the paste-like exudate stops fairly rapidly even without a valved nozzle.

You need to have your nozzle mounted very rigidly, because ABS is not that easy for the hot nozzle to plough through if there are any rough bits sticking up from the surface. This is another reason I found to use thin layers and go slowly.

Getting ABS to stay down on the bed is hard too, but by accident I made one of those handy discoveries: With an eye-dropper, put a few drops of acetone (methylethylketone for the new-fangled) on a wooden extruder bed where the printing will take place. This hugely improves the

adhesion to the bed, **BUT IS VERY FLAMMABLE!** Just bear it in mind, and keep the big can of acetone well away with the lid on just in case, eh? (PS What pen do you label little acetone bottles with? It all gets dissolved off when I spill it!)

Things bode well for an alpha release of the Ponoko lasercut components kit. I'm getting excited about that, and it should tie in nicely with the imminent arrival of Zach's new shipment of extruder motors on the RRRF site.

Oh, the curly-white wave flowing over the top of the big washer holding the extruder barrel is an ABS leak between the PTFE insulator rod and the top of the brass M6 extruder barrel. I hadn't anticipated the need to seal it, but the ABS starts pressurizing some way up the PTFE rod and squooshes out the gaps in an organic way. I'll seal the gap with PTFE tape when I install the latest extruder clamp assembly off the pending prototype lasercut run.

Vik :v)

RepStrap In Chains

Sunday, 5th October 2008 by Vik Olliver



On the left we have the "Shiny" lasercut RepRap/RepStrap, completely fitted out with ball-chain drive and it all feels just fine. No rattly movement, though some of the screw heads are catching in the Y motor coupling and motor mount. I'll have to add a few washers or shorten the motor-mount/frame coupling bolts.

The Z drive was tested by connecting it to Phoenix and using the Arduino electronics on there (you can see the Y stepper controller on Phoenix's frame lower far left). The Y and X axes were tested by engaging my electric screwdriver in the adjustment slot at the rear of the motors, and whizzing it back & forth. Not a full-on electrical test, but the mechanics should do the job.

I have also properly fitted the NEMA17 motor to the X axis on the now fully-assembled Phoenix, and that checks out okay - and I printed an ABS cat. All in all a very busy weekend.

Vik :v)

New Board: Arduino Breakout Shield v1.4

Wednesday, 8th October 2008 by Zach Smith

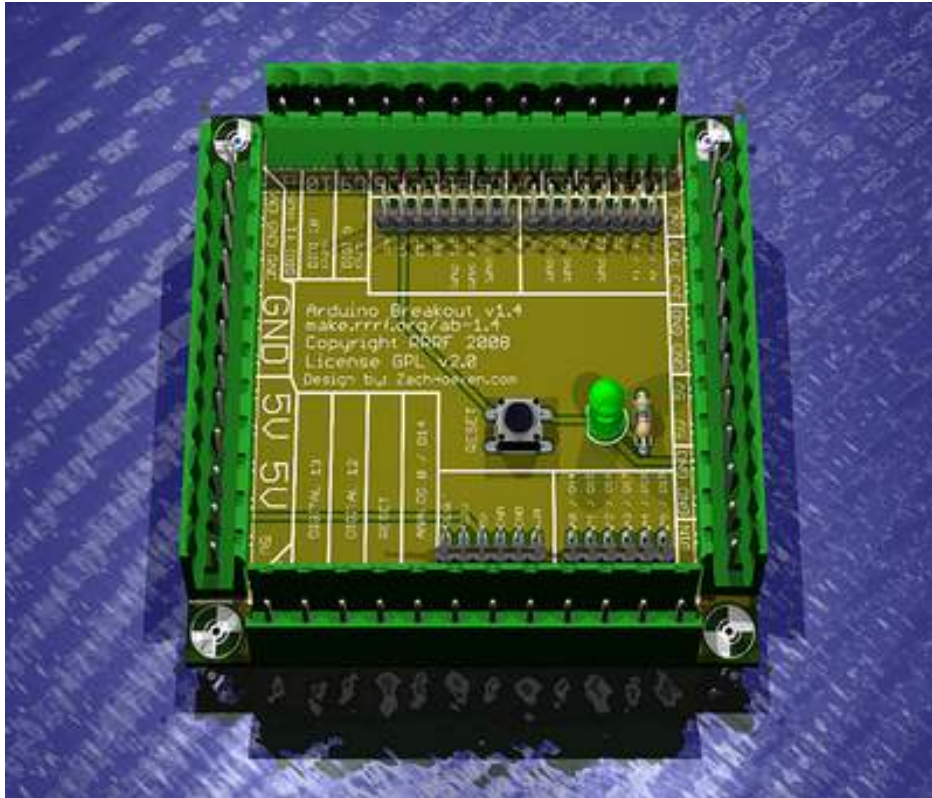

I sent a new board off to the fab today. This one is an incremental improvement on the super useful Arduino Breakout Shield v1.3. Here are the major things that have changed:

- * 4th row of GND / 5V terminals re-arranged to avoid shorting out on USB connector
- * added 2nd row of arduino-spaced headers to allow shield stacking
- * re-arranged reset / power led
- * made board square
- * added mounting holes!
- * tweaked silkscreen

I think with these tweaks, this board will be pretty awesome. I'm excited to get them back.

Source files posted to SourceForge, and are also available in subversion as usual. Documentation will be posted to the wiki as soon as i have boards in hand to document.

RS485 Circuit = Success

Sunday, 12th October 2008 by Zach Smith

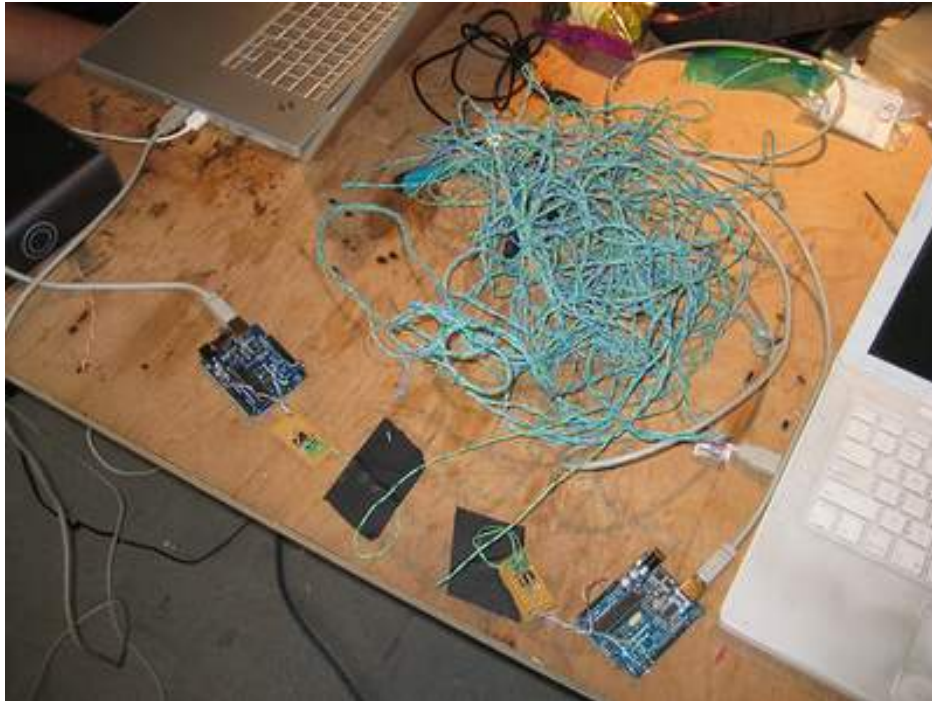

Recently, I've been working on the 'Generation 3' electronics based on the Sanguino / atmega644p chip. This new generation of electronics sets out to solve many different problems with the current electronics: modularity, simplicity of wiring, microprocessor power, as well as adding many new features: sd card support, lcd support, interface support, and much more. This next generation of electronics is a large topic, which I will cover in future blog posts, but for now I'd like to focus on one particular feature: the data bus for the modular extruder system.

If you remember back to the days of the Generation 1, PIC based electronics we had a token ring system where each part of the system had its own microcontroller and was connected via TTL serial. This system suffered from many flaws, including noise in the serial lines connecting the various microprocessors.

The Generation 2, Arduino based electronics fixed this by swinging to the opposite end of the pendulum: all the electronics are controlled by a single microprocessor and no serial data connections are required (except to the computer). The main disadvantage to this is that the Arduino is pretty underpowered to drive a complex system such as a RepRap machine. We managed to do it, but we had to take quite a few shortcuts. This basically means we're also pretty limited in the things we could achieve.

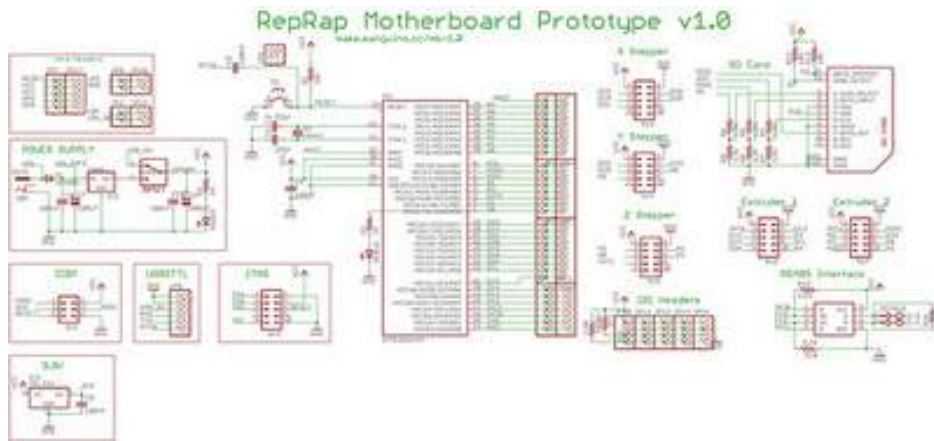

The Generation 3, Sanguino based electronics will swing back towards the middle, using a 'best of both worlds' approach. It uses a more capable microprocessor which solves the memory and pin problems. However, even with more pins its is still tricky to drive more than 2 extruders, or one extruder and an LCD screen / button interface. Thus, we need a modular system to allow expandability.

This long winded intro brings me to the subject of this post: RS485. This is a serial communications specification that uses differential signaling. The awesome thing about this is that it offers many cool things, one of which is improved noise immunity. As the wire contains the same signal twice (once normal, once inverted) When it gets to the other end, and the inverted signal is transformed into a non-inverted signal and combined with the original signal. Any electrical noise that was picked up is then cancelled out due to wave mechanics. Cool, huh?

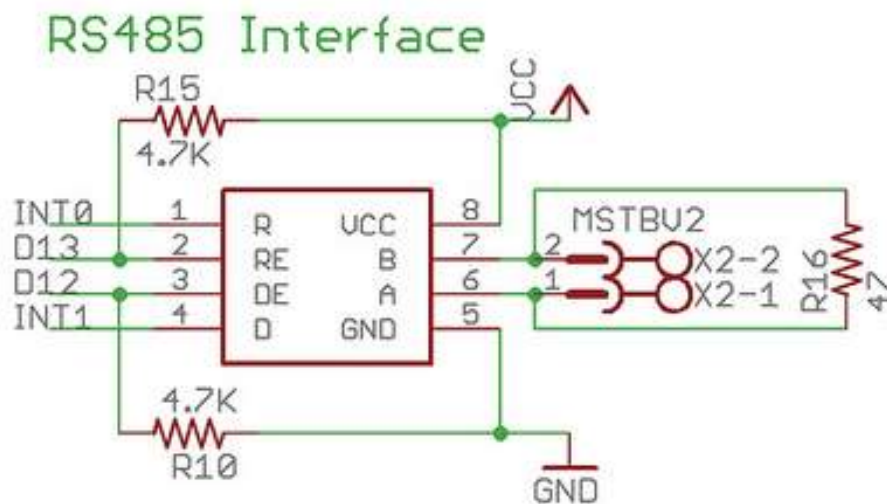

I'm not an electrical engineer, so this stuff is all pretty new to me. Fortunately, we have many smart people participating in the RepRap project with experience in many different areas. One of those people is Nophead, who you may remember from his excellent HydraRaptor machine. He might deny it, but he's an electrical genius and he gave me a chip number and a circuit for doing RS485 communications. Today I built and assembled it.

In the picture you'll see the eventual setup I had going. I wired up two RS485 circuits to two Arduinos, and wrote a quick sketch to get them talking. The connection was a very long long, unshielded, twisted pair cable from an old ethernet cable. I hooked all these up and started them communicating. It worked great! I also did a test to try and inject some noise into the system by operating a powertool right next to the wires. It was very unscientific, but the RS485 connection didn't skip a beat.

There was one problem that I ran into, which was easily fixed. The Arduino only has one hardware serial port, which was being shared by the RS485 chip as well as the FTDI usb -> serial converter chip that is on all Arduinos. The problem was that when uploading a new sketch to the arduino, the RS485 would also be sending and receiving data which would seriously mess with the uploading process. Luckily, the RS485 chip has both a transmit enable and a receive enable pin. I used the appropriate pullup/pulldown resistors to default these both to off so that when the Arduino was reset for the upload process, the RS485 was disabled. This means that I had to wire up an additional two pins on the arduino to control the RS485 receive/transmit status. This is not a big deal because using RS485 frees up a lot more pins than it uses, so there will be plenty of pins available.

Anyway, today was a good day of hacking. Hopefully later this week I'll be able to wire up the SD card and run it through its paces. Luckily for me, there are schematics and code already written for the Arduino all over the internet, which means that it will be fairly trivial to wire it up and getting it working on the Sanguino.

Yes - it's a square...

Wednesday, 15th October 2008 by Adrian Bowyer

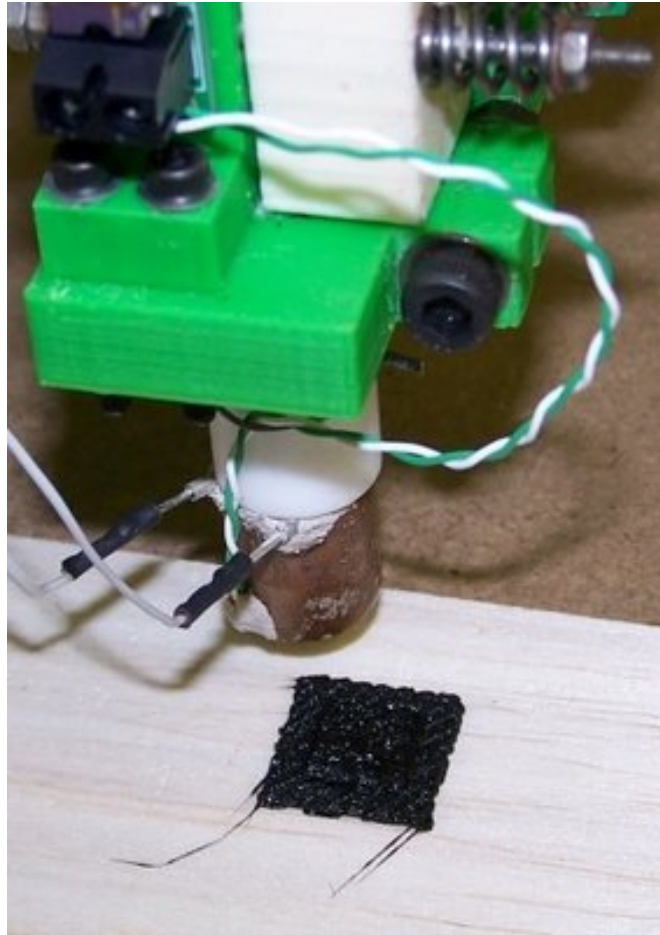

...but a square made by a Sanguino -controlled RepRap...

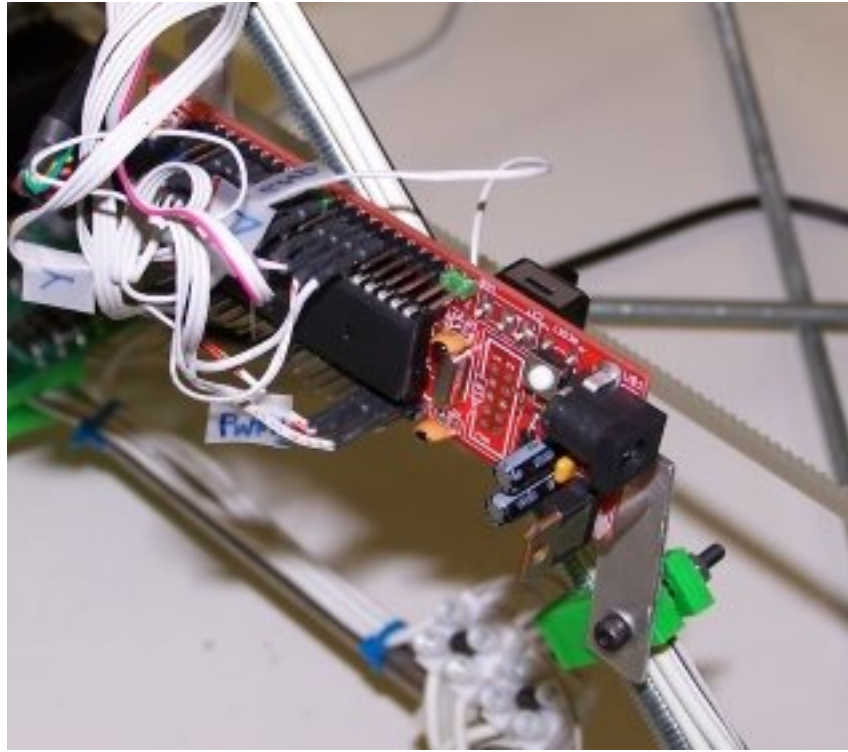

...running the G-code interpreter driven directly by the standard Java host software.

The control panel can now send G codes if they're switched on too, so you can control a G-code RepRap interactively.

I want to get to the point where we can drive both the Arduino and Sanguino running either the SNAP protocol or G-code all using the same program.

The next step is to reconfigure the Sanguino so it uses the latest pinouts decided by Zach to give the maximum electronic versatility.

ReplicatorG 0002 Release

Friday, 17th October 2008 by Zach Smith

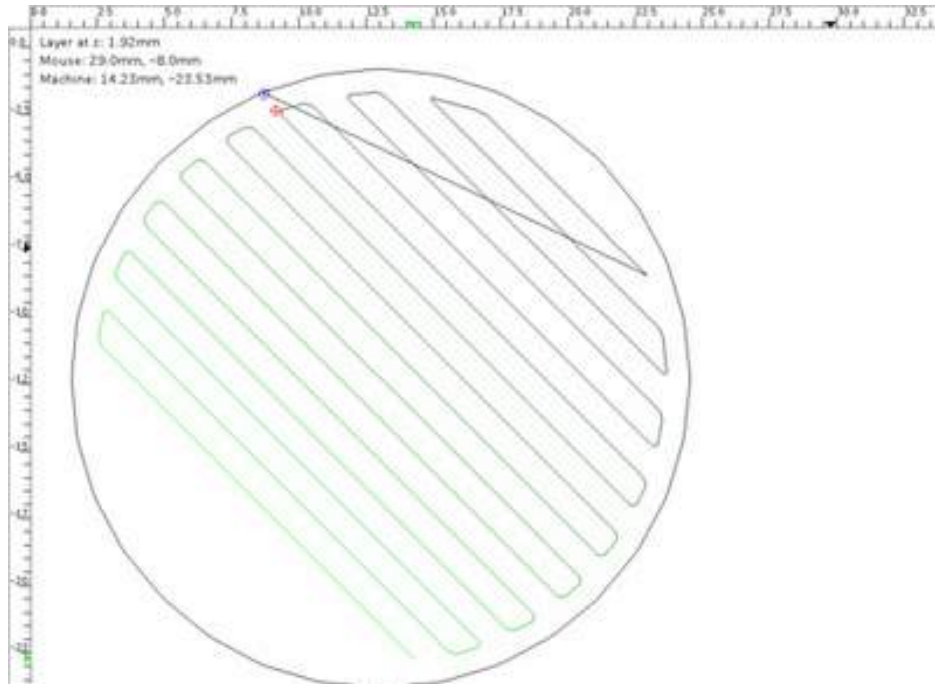

Today has been a busy day... I'm also releasing ReplicatorG 0002. If you're not familiar with this software, its a generic GCode host software designed for use with RepRap machines. You feed it a GCode file, it parses it and then uses a driver based system to control a RepRap machine. Its simple, modular, and expandable. Its based on the Processing/Arduino codebase so it has a nice, friendly GUI system. Its also cross-platform straight out of the box. The installation process is pretty straightforward: download it and run it! You might have to install Java if you dont already have it.

Anyway, here is the changelog:

- * add units to simulation window
- * add proper bounds to simulation window
- * add warmup/cooldown to machine config
- * add simple exerciser / status window
- * add color to simulation window
- * add up/down arrows to simulation windows
- * implement Peter Edworthy ideas on driver instantiation
- * have simulation move to a proportional wait time
- * fix build time estimation
- * add estimate menu item
- * add basic machine configuration stuff to XML (axes, resolution, extruders, toolheads, clamps, etc.)

- * move to a controller/model/driver system.
- * Add an extruder section (temp, start/stop extruder, extruder direction, extruder speed)
- * added text boxes to control/display feedrate data
- * fix shutdown of driver
- * fix windows icons

You can [download ReplicatorG](#) from google code, or head over to the [Replicat.org website](#) to learn more about the software.

Sanguino Software v1.3 Release

Friday, 17th October 2008 by Zach Smith

I'm happy to release the v1.3 of the Sanguino software. This is a compatibility update for the Sanguino. I've fixed some minor compatibility issues with some of the core Arduino libraries.

I've tested and fixed the following libraries:

- * LiquidCrystal - for controlling LCD displays
- * Servo - for controlling servo motors

I've fixed, but not tested the following libraries (need circuits to test on):

- * Wire - for talking i2c to various things
- * Ethernet - for doing ethernet communication

Anyway, you can download it from SourceForge or check out the Sanguino homepage.

Lasercut RepRap Available in Australasia & US

Sunday, 19th October 2008 by Vik Olliver

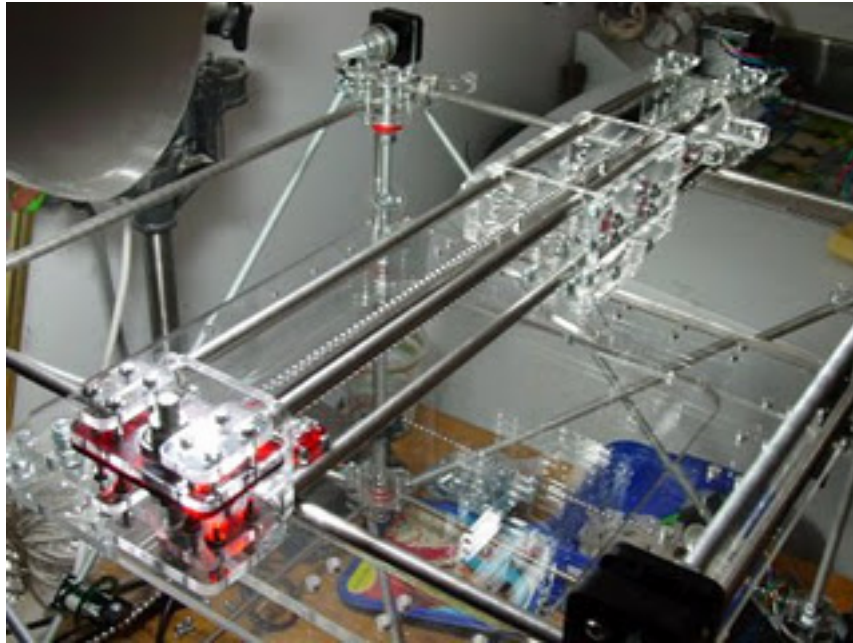

At long last, I have got the lasercut RepRap kit online, available now from Ponoko [here](#). Cost of the lasercut components is approximately US\$380 plus shipping, and it is compatible with the electronics kits and motors sold by the [RepRap Research Foundation](#). As you can see from the photo on the right of the X axis assembly, it uses ball-chain instead of 2.5mm timing belt. What you can't see is that it also has an option for using lasercut bearing races instead of skater bearings. That worked really quite well.

I've bearily started the instructions [here](#). The instructions on the [BitsFromBytes](#) page are generally applicable and will fill most of the gaps, though the Ponoko variant does use more laminated parts to avoid having to use routing. I recommend using all clear acrylic as it is much easier to see through the parts and see what you're doing!

I have also started acquiring Australasian suppliers for PTFE rod, PLA filament, fine nichrome wire and stepper motors with a view to making a complete electronics kit available from local sources.

Hopefully we can redress the balance and get a few more RepRaps going in the Southern hemisphere!

Vik :v)

Multimode Host Software

Saturday, 25th October 2008 by Adrian Bowyer

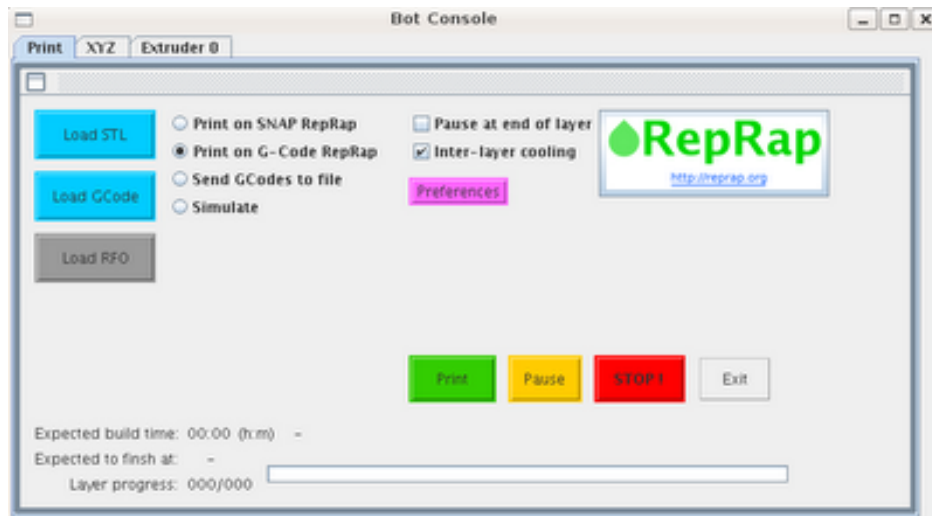

I have been working on the Java RepRap host software. The latest version (<https://reprap.svn.sourceforge.net/svnroot/reprap/trunk/reprap>) allows you to:

- Load STL files and print them on a SNAP RepRap (PIC or Arduino).
- Load STL files and print them on a GCode RepRap (Arduino or Sanguino).
- Load STL files and print them as GCodes to a file.
- Load a GCode file and print it on a GCode RepRap (Arduino or Sanguino).

The next step is to put a simple GCode interpreter in there that will allow the final combination: sending a GCode file to be printed on a SNAP RepRap. Also, before doing a release, I need to do a bit more testing (so far I have tested the Sanguino stuff but not the Arduino, for example, as my home machine is Sanguino). I also need to get the progress indicator working with the print-from-GCode-file option; it works with all the others.

The transmission using GCodes is buffered through a separate thread which makes it pretty smooth. This works particularly nicely with GCodes stored in a file (as with Zach's ReplicatorG), and gives good-quality builds. As soon as I've got something more interesting than a cube, I'll post it.

I've had to change a few preferences values - see <http://www.reprap.org/bin/view/Main/RepRapSoftwarePreferencesDocumentation>.

Finally, you'll see that there is a greyed-out button for "Load RFO". This is the format that Zach proposed along with the Fab@Home guys for multiple-material builds (see <http://reprap.org/bin/view/Main/MultipleMaterialsFiles>). Watch this space...

New Board: LCD Controller v1.0

Sunday, 26th October 2008 by Zach Smith



This is a fun board that has some really cool potential. It was primarily designed by Bruce Wattendorf who did the heavy lifting on finding the right chip, prototyping it, and figuring out all the technical details. I hacked on it a bit to get it ready for production with proper silkscreen and such.

The heart of the board is an MCP23S17 chip made by Microchip. This chip is really cool: it is a 16-bit port expander that you can communicate with via i2c. They also make a nearly-identical one you can talk to via SPI. Our board supports both of those chips. We chose to go with i2c, because it is fewer wires and slightly easier to interface.

The board is designed for the upcoming Sanguino Motherboard which will have matching i2c headers, although you could talk to it with anything that is an i2c master. We only needed 11 pins for the LCD screen, so we've provided the remaining 5 pins as headers for your hacking pleasure. We're planning on making a breakout board with some buttons, or perhaps LEDs. You could easily make your own as well with perfboard.

LCD Interface v1.0

<http://make.rrrf.org/lcd-1.0>

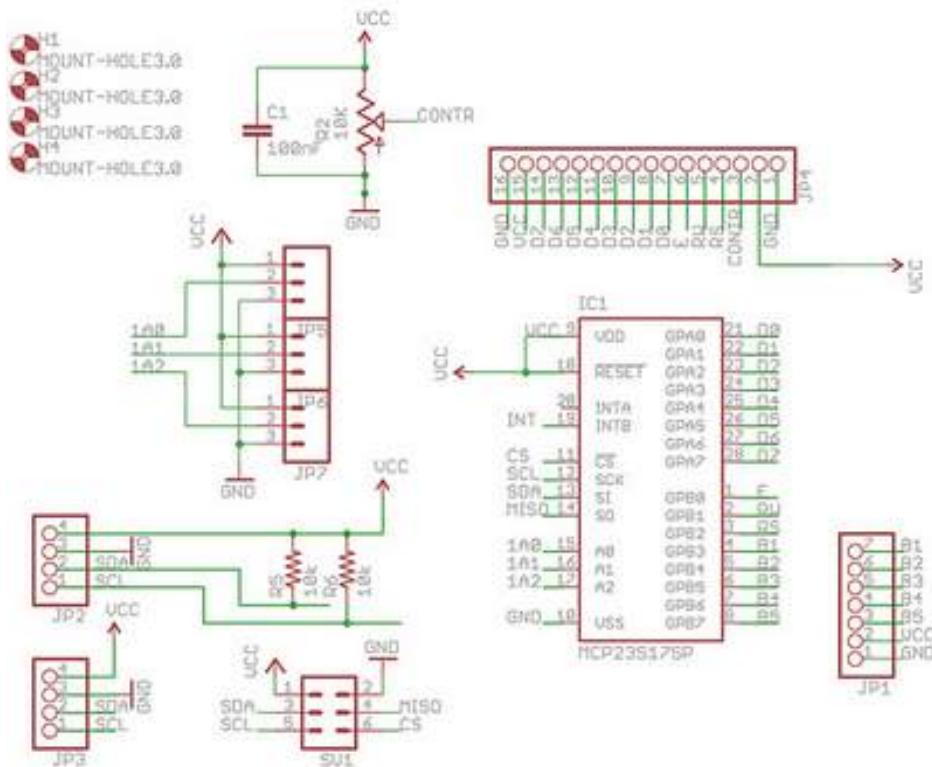

If you'd like to download the design, its [available on SourceForge](#). We just sent it to the fab today, so it will be at least 10 days until we have prototypes back. Boards and kits will be up on the RRRF store ASAP.

Finally, big thanks to Bruce for his help and contributions. I'd also like to take the opportunity to point out that this type of collaboration is what the RRRF is for: to help researchers and contributors to the RepRap project see their ideas reach fruition. The RRRF funded the prototypes for this design and might fund yours as well. If you have a design for something that fits with the goals of the RepRap project, please email me at hoeken@rrrf.org. We don't have funding, so all the money for research comes from sales at the [RRRF store](#) if you'd like to support us.

Oh, and here's a video from Bruce:

[RepRap I2C LCD test board from Bruce Wattendorf on Vimeo.](#)

New code first build

Sunday, 26th October 2008 by Adrian Bowyer

Ever since we decided to separate the computation of slices from the driving of the RepRap machine by writing the computed slice movements to a G-Code file then subsequently re-playing that on the machine, we have known that that strategy would improve quality. This is because it removes dwells and delays from the build caused by the slicing code having to perform (sometimes quite intensive) computations. The G Code file has exactly all the right speeds and delays in it, and there is no significant delay in transferring the commands to the RepRap machine from simply reading a file.

This improvement was confirmed experimentally and in production by Nophead's Hydraraptor work, and by Zach's ReplicatorG G-Code RepRap-driving program.

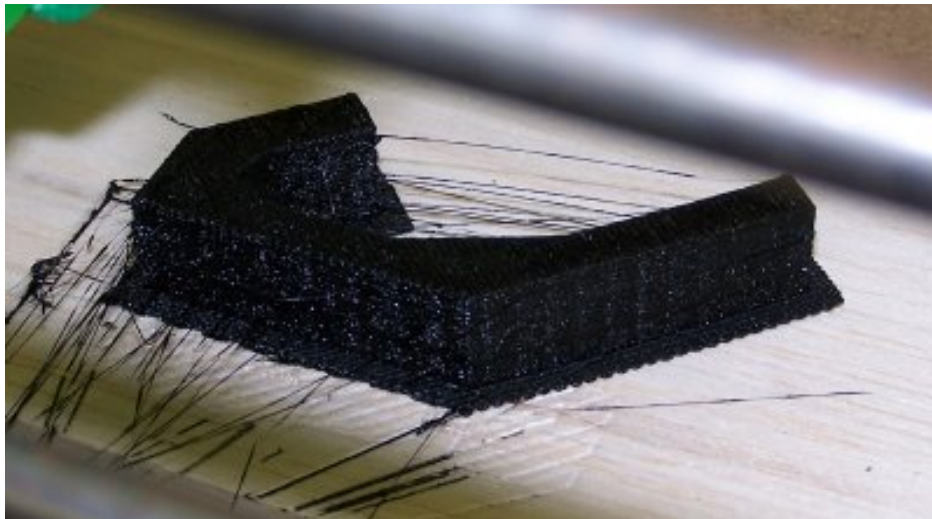

Here is the first build out of the standard RepRap Java host software updated as in the post below. It's the RepRap coat hook. I computed the slices and saved them to a GCode file (this took about 12 minutes). Then I replayed the file (this took about an hour and a half). This was on my home RepRap, driven by a Sanguino running the Sanguino GCode firmware extruding ABS at 240 °C.

Above is the coat hook unretouched just after the build finished.



And here is it after brushing the hair off. The quality is almost as good as the superb results that Nophead gets, at which I am well-chuffed as I haven't finished tweaking the parameters yet.

One tiny bug became aparent: the Java hangs writing the GCodes to a file if the RepRap machine isn't plugged into the computer's USB port, even though nothing is going to the RepRap machine at that stage. Now I'm off to hunt that one down; I suspect I may have been too clever adjusting thread priorities...

Tomorrow, Ed and I will get together in the lab at Bath to make sure this all works with the Arduino (which we have on the lab machine) as well as the Sanguino.

Exchangeable Lasercut Extruder

Wednesday, 29th October 2008 by Vik Olliver

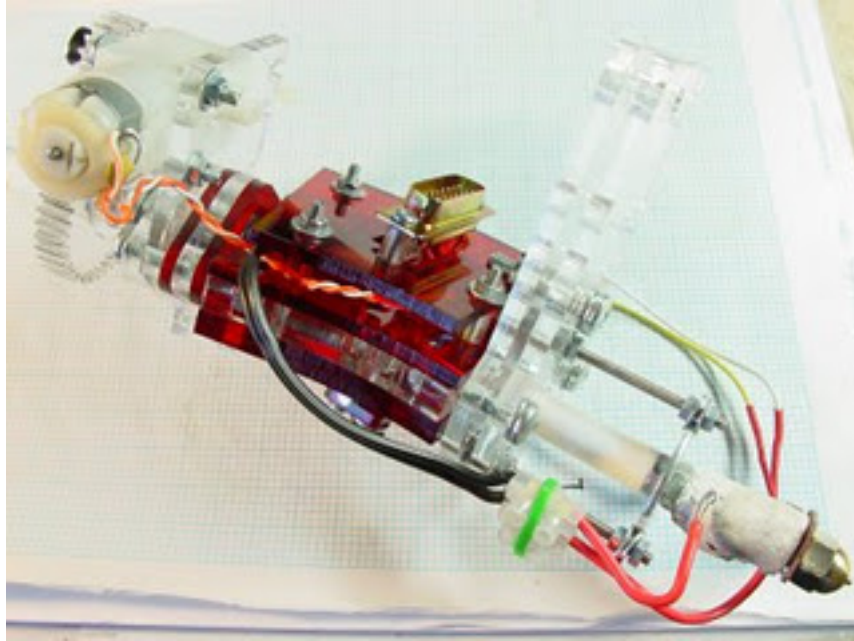

I've been working on the design of the Ponoko lasercut extruder. I've managed to make it fit better into the extruder socket and even made the "handle" on the extruder clamp variable in width for maximum grip by putting a split in it.

By tightening or loosening the M5 locknut on the screw that goes through the "handle" (roughly in the centre of the picture) you can pull its two halves, expanding or shrinking the handle's thickness.

The whole thing is compatible with the [Darwin exchangeable extruder](#), and in fact seems more rigid. If there's an interest in making the extruder available as a kit on its own, let me know and I'll do so.

In the photo, the red pieces are made from 3mm acrylic, the gears from 8mm and the rest from 4.5 mm. I've also made parts to hold an opto sensor in place which I've not fitted and a 1:1 gear set that I've yet to try out. Busy writing [assembly instructions](#)...

Vik :v)

Puddle to the Metal

Thursday, 30th October 2008 by Adrian Bowyer

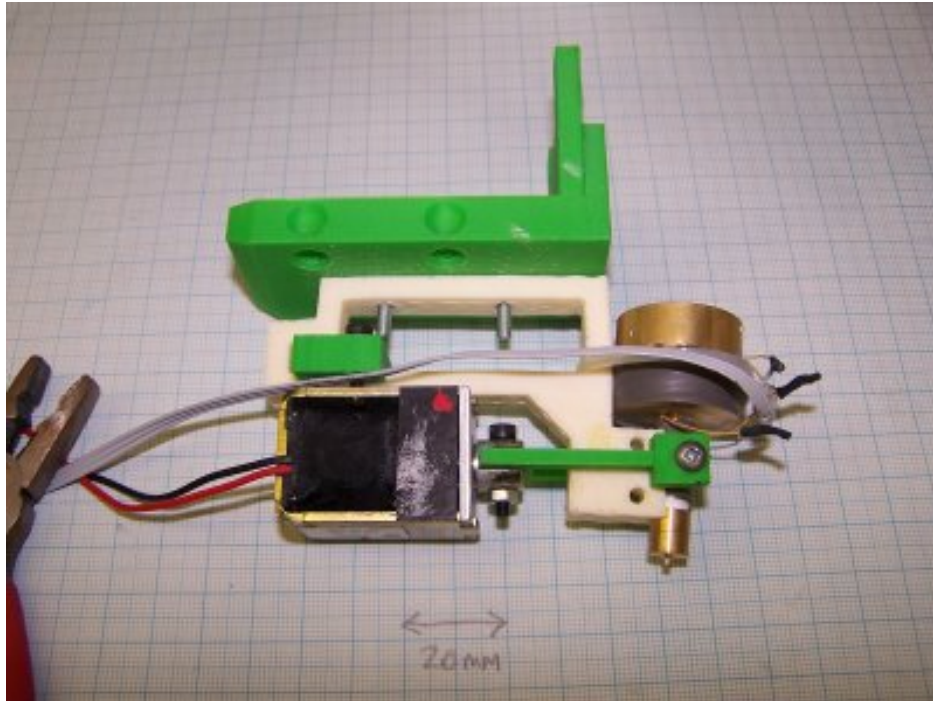

I don't normally blog mere links, but with progress being so rapid recently we'll revivify the metal-inlay extruder very soon so we can do electricity. So here are some materials that we could use for that:

<http://www.princeaugust.ie/alloys/>

Note that one would also be able to cast just about all of these in a silicone mould.

Lasercut RepRap Extruder Instructions on Wiki

Thursday, 6th November 2008 by Vik Olliver

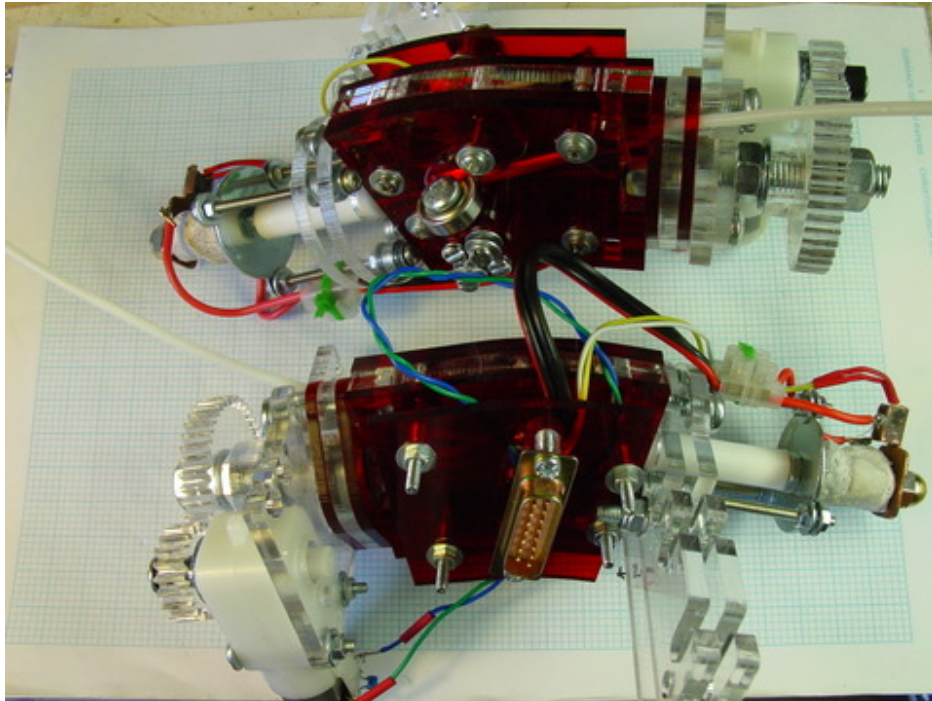

I've put the instructions up for assembling the lasercut Ponoko RepRap Extruder here:
<http://reprap.org/bin/view/Main/PonokoExtruderAssembly>

It's a fairly basic design, but copes with a range of motors. The instructions include some directions on improvised lathing techniques for those of you who do not have access to a lathe.

Feedback welcomed.

Vik :v)

About !*\$!*&! time...

Friday, 7th November 2008 by Adrian Bowyer

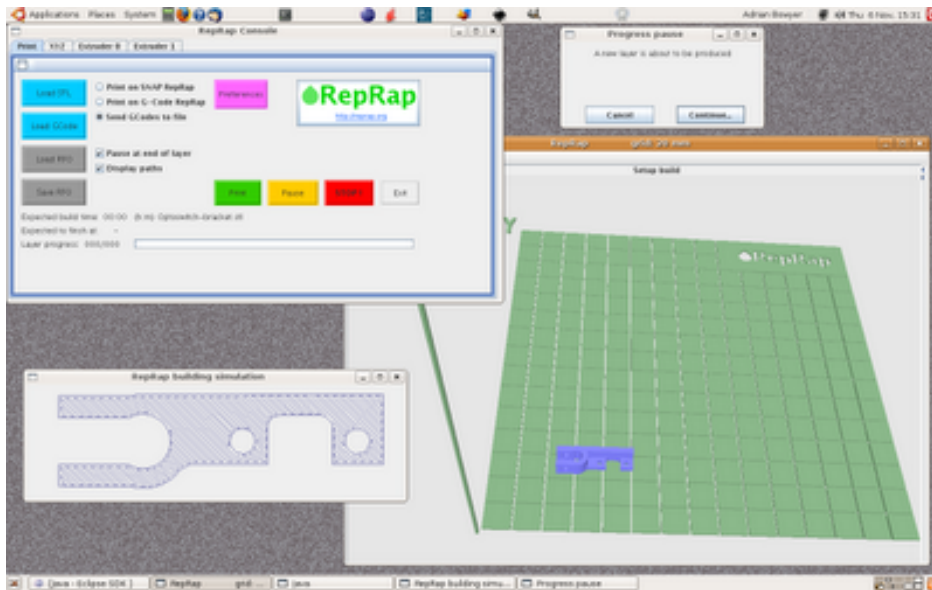

I have (finally... sorry) updated the documentation on how to use the Java host software. It's linked from the left menu bar of the RepRap website under [Using a RepRap](#) and from that link too.

I've also put in a few tweaks, like a 20mm grid on the build base to make it easier to position things.

Comments and abuse welcome...

DIY PLA

Tuesday, 11th November 2008 by Adrian Bowyer

Forrest has just reminded me that I should have blogged this ages ago.

Bath undergraduate Nick Grudgings did some experiments on making polylactic acid. Here's his setup:

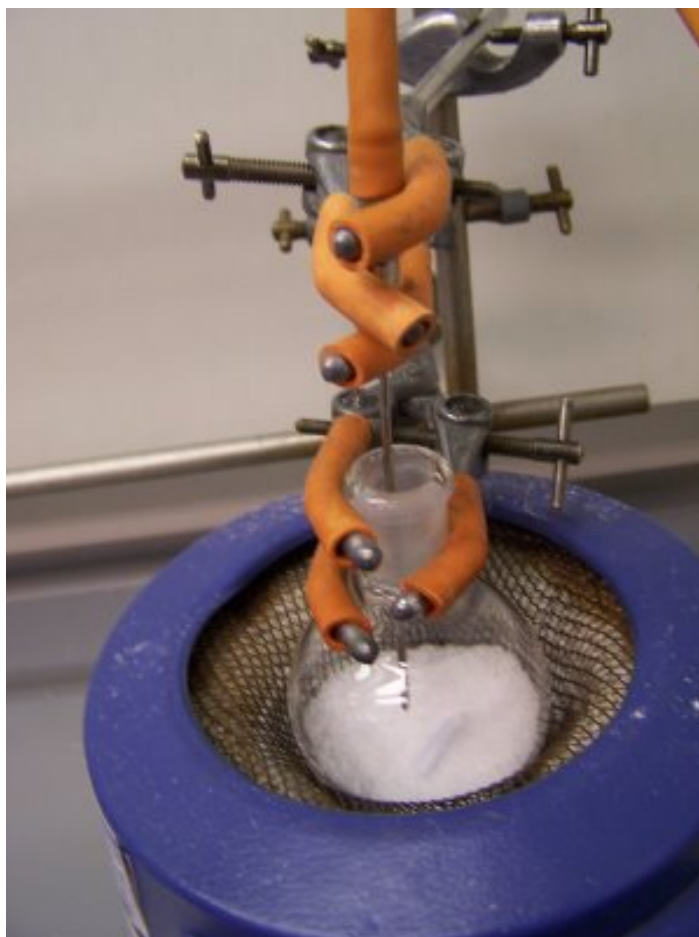

The flask contains lactic acid, and is resting in a heater. The tube is feeding in dry nitrogen to eliminate moisture. There's a magnetic stirrer flea under the lactic acid that you can't see. We also put in a thermometer. The whole thing was in a fume cupboard, as you don't want to breathe lactic acid vapour...

We warmed it up gradually, with the stirrer turned on. When the lactic acid started to melt we added 1/600 by weight of tin octoate as a polymerisation catalyst. The melt became quite viscous at around 140 °C as polymerization started. You can control the mechanical properties of the result by the amount of catalyst: the polymer chains form from each catalyst molecule, so more catalyst means shorter chains.

Here's the result:



At the bottom of the flask is a cool solid clear lump of poly(lactic acid), with - it turned out - a little residual lactic acid embedded in it.

After a while (weeks) that lactic acid started to absorb atmospheric water vapour and thereby to disrupt the polymer, from which we learned that we needed to cook it for longer (we used about half an hour) to complete polymerisation. Obviously the longer the polymer chains you go for, and thus the less catalyst you use, the longer the polymerisation will take.

Multiple materials

Sunday, 16th November 2008 by Adrian Bowyer

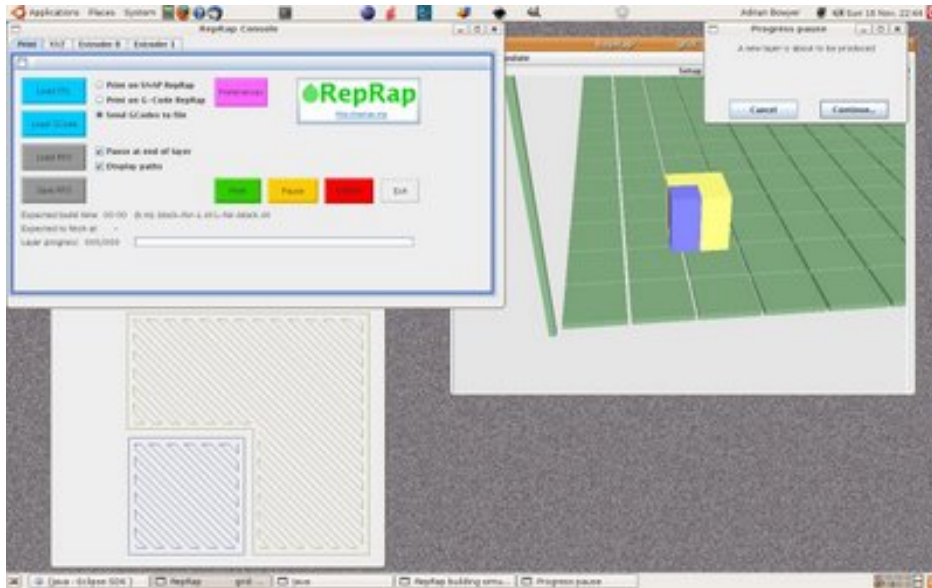

The Java host software is now set up to handle objects made from any (reasonable) number of materials. If you load an STL file, select it with the mouse, then load another the system keeps the relative position and orientation that the two had when they were created. Thus you can design something in several materials, save each as an STL, and then load them all together.

As you can see, the sectioning software distinguishes between the two and creates the correct outline and hatch patterns for each.

So far I have tested this on an Arduino-controlled RepRap with LEDs in the place of the extruder motor and valve (because I only have one extruder here at the moment). The LEDs all seem to light up and go out at the right times.

This is cheating slightly, as the Arduino only has enough pins for one extruder, but if you have two, one of which just needs a motor like our [plastic extruder](#), and the other of which just needs a valve, like our [prototype paste extruder](#), then you can control both.

Next I'll update the paste extruder design and get that working again, and see what we can make.

Then I'll upgrade the Sanguino (more pins...) software so it can genuinely handle two extruders.

This, of course, will allow us to use different support materials, and also fun stuff like silicone rubber and Field's metal.

Announcing Thingiverse.com

Monday, 17th November 2008 by Zach Smith



Image not found.

or, "Why you need a RepRap machine"

One of the most frequent questions I get after people understand what a RepRap does, is a variant of either 'Why do you need a machine like this?' or 'What do you make once you have one?'. Well, Thingiverse.com is an answer to that. This is no ordinary object sharing website. Thingiverse.com is a home for all your digital designs. If you can represent a physical object digitally, then we want it on Thingiverse. You can upload 3D files for a RepRap machine, vector files for a lasercutter, or even a PDF of instructions on how to build a sock puppet.

One of the tricky things with digital designs for things is that your average web browser doesn't know an STL from a dodo, which is why we support automatic renderings of common digital design formats. If you give us a file, we'll try our best to generate a rendering of it so that when people come to look at it or download it, they will be able to know what it is. We support STL, DXF, SVG, AI, and many other formats including Eagle PCB design files. Even if we don't support rendering it, we'll still put it up for other people to download. Not only that, but once we add support for your file, we'll render the previously uploaded files of that type too. Yay!

The dream behind [Thingiverse](http://Thingiverse.com) is that someday in the not so distant future, when everyone has a RepRap machine, they will be able to go to Thingiverse.com, find a useful/interesting/cool thing, download it, print it, and 15 minutes later be able to hold the actual thing in their hands. This is the coming revolution of digital fabrication and we want to help you make it happen. If you want to be involved, now is the time to [step up and get involved](#).

Idea for reduced cartesian structure

Monday, 24th November 2008 by eD

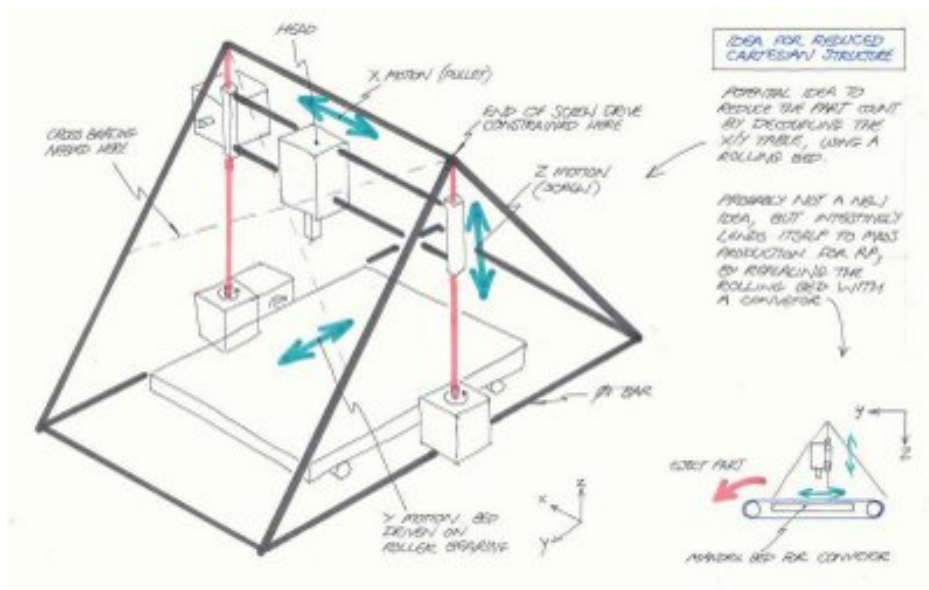

I've been playing with ideas on part count reduction for Darwin. Having an elevated XY table requires a fair bit of support structure. After brainstorming with Adrian we came up with this as a concept - I will try to do a feasibility on it at some point. Interestingly the rolling table concept could lend itself well to a large-batch production machine: if the table was pimped with a conveyor we'd have an infinitely long work area.

Heating the print surface: doing the numbers

Thursday, 27th November 2008 by Forrest Higgs

Scaling up Metalab's heated printing surface...

Recently, Marius, at Metalab in Austria, reported that printing onto a heated surface solved the problem of getting plastic to stick AND greatly reduced warping of the printed object. As you might imagine this report drew a considerable amount of interest, since warping has been one of the most serious technical challenges faced by the Reprap project.

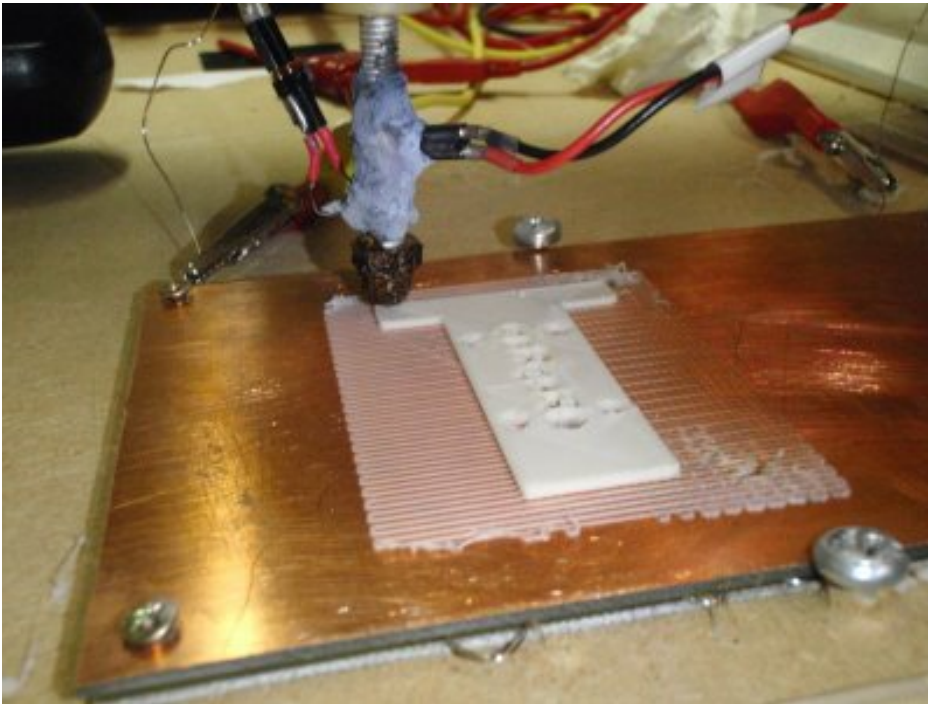

Metalab simply placed a layer of what appears to be mineral fiber cloth on top of their particle board working surface, placed what appears to be heavy gage nichrome wire on top of that and then placed a single sided raw printed circuit board, copper side up, on top of that. From the placement of the power clips it appears that they attempted to heat the whole surface.

My first problem was to determine the area that they were trying to heat. The configuration looked familiar, and in this picture from Marius' blog he was attempting to print a standard old-style Mk II filament guide. I prototype my controller boards, as a rule on Euroboard scaled stripboards, those being easy to acquire where I live. I pulled a spare Euroboard and a filament guide from my stocks and quickly determined that Metalab was also using a Euroboard scaled printed circuit board.



What that means is that Metalab was heating a 10x16 cm surface. At the end of Marius' blog entry he demonstrates a second pass at the design problem.

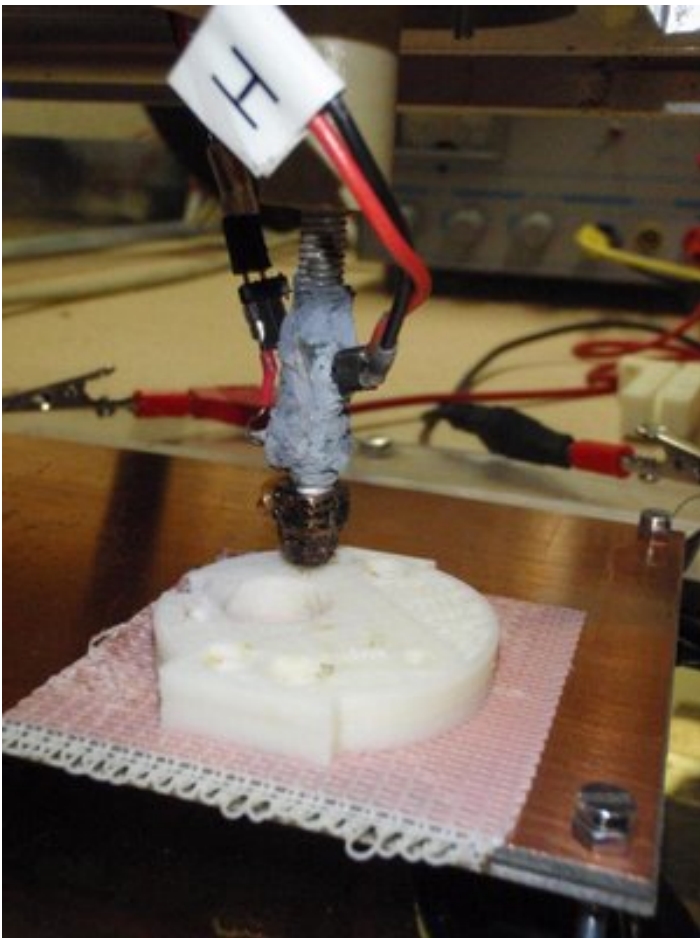

Here you can see that they've simply sandwiched the nichrome between the fiberglass sides of

two Euroboards. It's an elegant solution at that scale if not particularly energy efficient or scalable. What is important, however, was that for this design they gave parameters for the nichrome heating element that they used successfully.

The base plate consists of two standard epoxy/copper PCBs with a ca. 9 Ohm nichrome wire sandwiched between them and fed with ca. 15 volts. This resulted in a base plate temperature of around 120 degrees celsius.

Applying Ohm's Law one quickly finds that this board draws 1.67 amps at 15 volts or roughly 25 Watts of electricity to heat it.

Doing a quick scaling of that load to Tommelise 2.0's working surface, 12x12 inches or ~930 cm², the scaling factor works out to...

$$930/(10 \times 16) = 5.8$$

That means that to heat Tommelise's full print surface I am looking at...

$$(25 \text{ Watts})(5.8) = 145 \text{ Watts.}$$

Given that Tommelise 2.0 only draws about 20 Watts max while operating, that is a rather huge additional amount of energy to use.

Because of that, I decided to do some quick calculations to see if I could see a way clear to get a better handle on this problem. To begin with, Metalab is radiating off of a clean copper surface. That gives you an emissivity of about 0.1. Assuming an ambient temperature of about 20 C, a heated surface of 120 C and applying that information into an expression of a formula for radiant exchange which assumes an ambient emissivity of 1.0, you plug numbers into an expression like this...

$$\dot{q}_{\text{net } 1 \text{ to } 2} = \frac{\sigma(T_1^4 - T_2^4)}{\frac{1}{\epsilon_1} + \frac{1}{\epsilon_2} - 1}$$

You get an energy requirement due to outgoing radiation of about 4.4 Watts. Please note that this is for one radiating surface, not two as Metalab has., so the outgoing radiation from a Metalab configuration would be about 9-10 watts. This is over a magnitude less than what Metalab reports. At a similar temperature differential one would expect natural convection losses in a still air environment

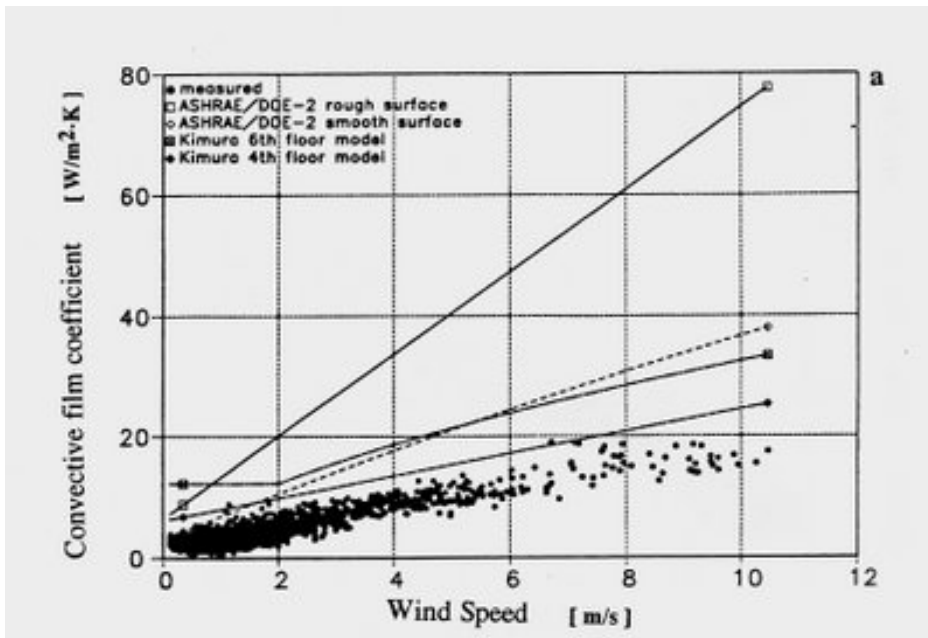

M. Yazdanian and J. H. Klems, Measurement of the Exterior Convective Film Coefficient for Windows in Low-Rise Buildings, ASHRAE transactions, v100, Pt. 1, pp 1087-1096, 1994. to be running something on the order of 2-4 Watts K/m². For our work surface this would be on the order of 10-20 Watts/side. That would mean that we would be looking at a total energy demand of around 30-50 Watts for a Metalab configuration in a still air situation. Kick the convection level up to, say 4 meters/second as we do when we direct an air stream at the top of the printed surface and your convection contribution would increase by a factor of five on the top side of the heated surface. With such a configuration you'd be looking at...

9 Watts (radiation) + 10-20 watts (bottom side convection) + 50-100 Watts (top side convection) = ~70-130 Watts

Metalab chose copper as their print surface. Providentially copper has a very low emissivity (~0.1). If they had used anodized aluminum instead, they would have been looking at a radiation fraction for a single side of around 70 Watts. Similarly, if they had printed a raft across the whole top side they could expect to be an effective emissivity of the top of the raft of 0.95 which would have raised the radiation contribution of that side to just over 80 Watts.

Obviously, we can greatly improve on the performance of the Metalab design, which was purely exploratory in nature. Insulating the bottom half of the printing surface would effectively reduce the energy demand by a bit less than half.

With respect to materials, while the printed circuit boards have the rigidity to handle surface deflection on a Euroboard scale, I doubt that they can be reasonably expected to do so at wider spans given the depth of the boards. Cross-bracing under the printed surface assembly should, however, put that right. Another question remains as to how the fiberglass printed circuit boards would handle 100 degree heating and cooling cycles over a long period.

The one thing to remember is that while the heated printing surface offers us a technical fix to the warping problem that is unlike anything developed heretofore, it has substantial energy requirements. Taking such an option would pretty much put paid to the notion of Reprap machines operating off batteries in a third-world environment.

Award for RepRap?

Friday, 28th November 2008 by Adrian Bowyer

Do you think RepRap should get an award? (I do, but then - I'm biased :-))

I just got the following e-mail:

"The Society of Manufacturing Engineers (SME) is now accepting nominations for its RTAM Industry Achievement Award. If you know of someone that has done fantastic work in the additive manufacturing (RP) industry, please visit <http://www.sme.org/industryaward> for details on submitting nominations.

"Nominations will be accepted through January 31st, 2009, and the award will be presented at the RAPID conference on May 12, 2009 (Schaumburg, Illinois)."

And we wouldn't dream of nominating ourselves, of course...

Suppression

Sunday, 30th November 2008 by nophead

Zach kindly sent me a sample of his PCB version of the radio interference suppressor that I designed for the GM3 gearmotor.

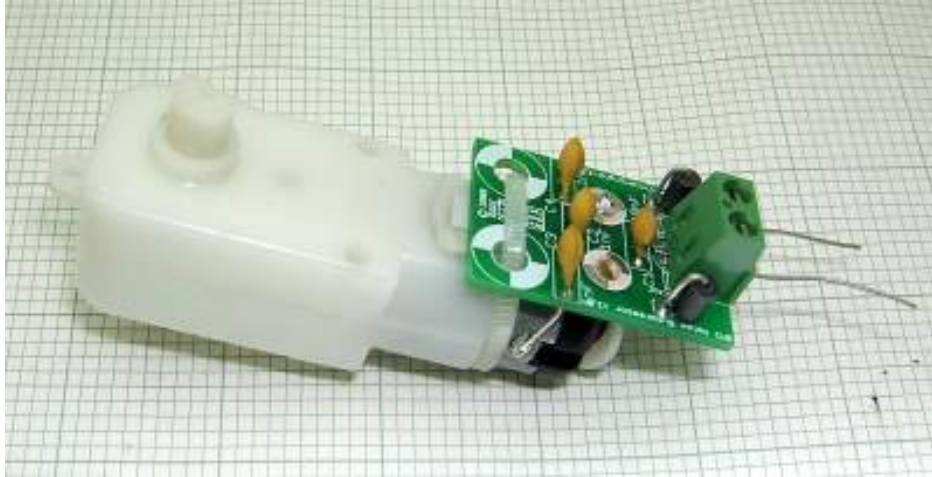

I have tested it and am pleased to report that it works at least as well as my prototype, possibly better.

Here is the noise spectrum without it fitted.

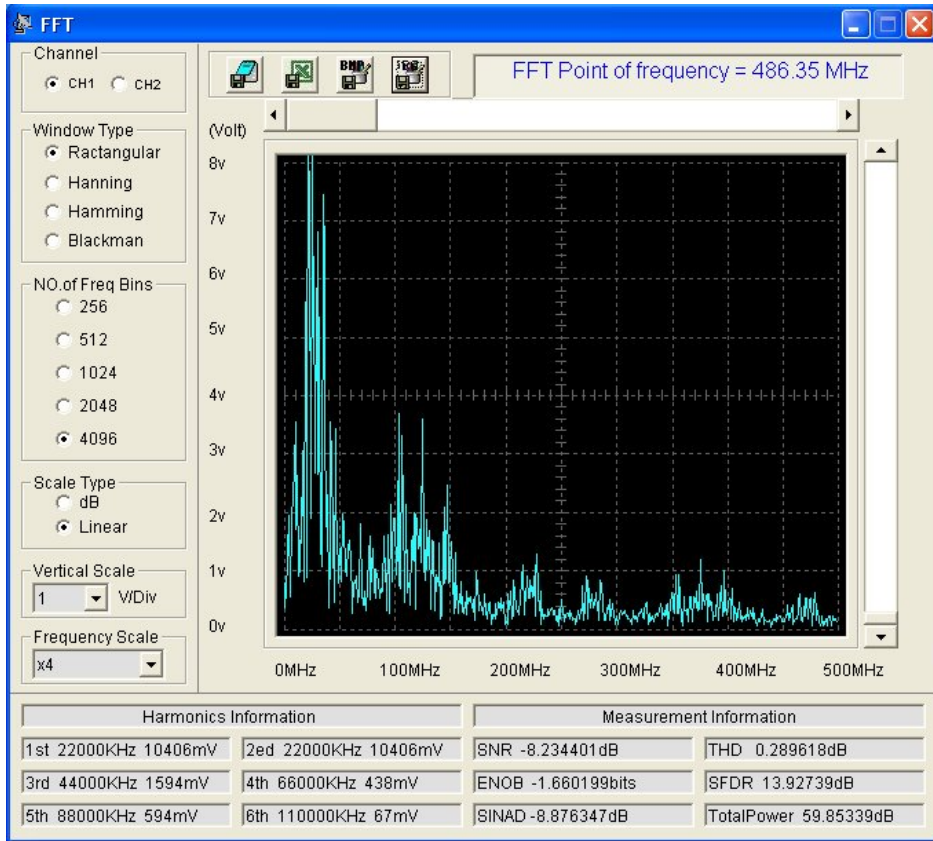

And here is the result of fitting it: -

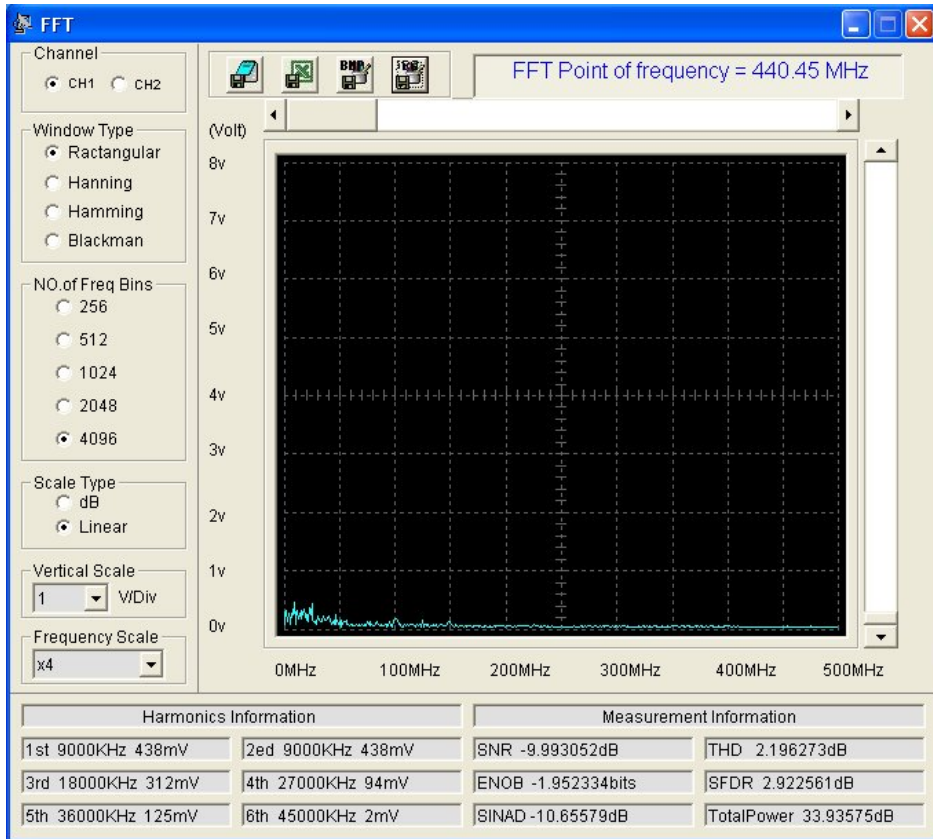

More details here: [hydraraptor.blogspot.com/2008/11/suppression.](http://hydraraptor.blogspot.com/2008/11/suppression)

Sphere

Sunday, 30th November 2008 by Steve DeGroof



I tried an experiment in support material. The idea was to use the same extruder for both support and build. The host software allows you to do this but it's a relatively recent change. It's not available in any of the official releases (I think, correct me if I'm wrong on that) but, if you build from the SourceForge source, you can do this.

The first thing I did was create a second extruder in the host settings. I copied all the Extruder0 settings and made them Extruder1, then set NumberOfExtruders=2. Extruder1's settings differ from Extruder0's like this:

```
ExtrusionInfillWidth(mm)=2.4 (instead of 0.8)
NumberOfShells(0..N)=0 (instead of 1)
ExtrusionSpeed(0..255)=175 (instead of 215)
MaterialType(name)=support (instead of ABS)
```

The intent here was to make a sparse and loosely-bonded mesh. The lower extrusion speed causes the ABS to be stretched into thin threads. The wider infill width creates an open weave pattern. The zero shells removes the outline around each layer. The end effect is a structure that looks a bit like a plastic pot scrubber.

To test, I used a 20mm sphere with a support object. I exported the two objects as sphere.stl and sphere-supt.stl. Now, to get the two objects to print together, you have to do this:

1. Load sphere.stl (when prompted, choose ABS)
2. Select the object (this will bond the object to the next one loaded)
3. Load sphere-supt.stl (when prompted, choose support)
4. Position and orient the (bonded) object in the build area

Note: The select-and-load thing to bond objects is a relatively new feature too.

The first image above shows the object as printed. The blobiness is mostly due to not having a proper nozzle cleaner yet. The second image shows the object after picking the support material off using my fingernail. The support material crumbled off fairly easily from the lower layers but was more difficult on the upper ones. The third shows the object after cleanup using a Dremel.

The upper layers of the support object are probably unnecessary and do more harm than good. The build can support itself once it's past a 45 degree overhang. I might try again with smaller support object.

Sure, it's a long way to go to make what's essentially a marble but it was an interesting experiment. I haven't tried anything with a purely-horizontal overhang yet. Not sure how that'll turn out.

Granule Extruder - the sequel

Sunday, 30th November 2008 by Adrian Bowyer

I've rabbited on about granule extruders before. I think it's important to have a design for one as:

- Granules are the standard form that plastics are supplied in,
- It's easy to make granules yourself by shredding, thus RepRap becomes a home plastic recycling machine, and
- If you have a hopper full of granules as the feed, it's much more compact than a plastic filament, and also very easy to refill in mid-build.

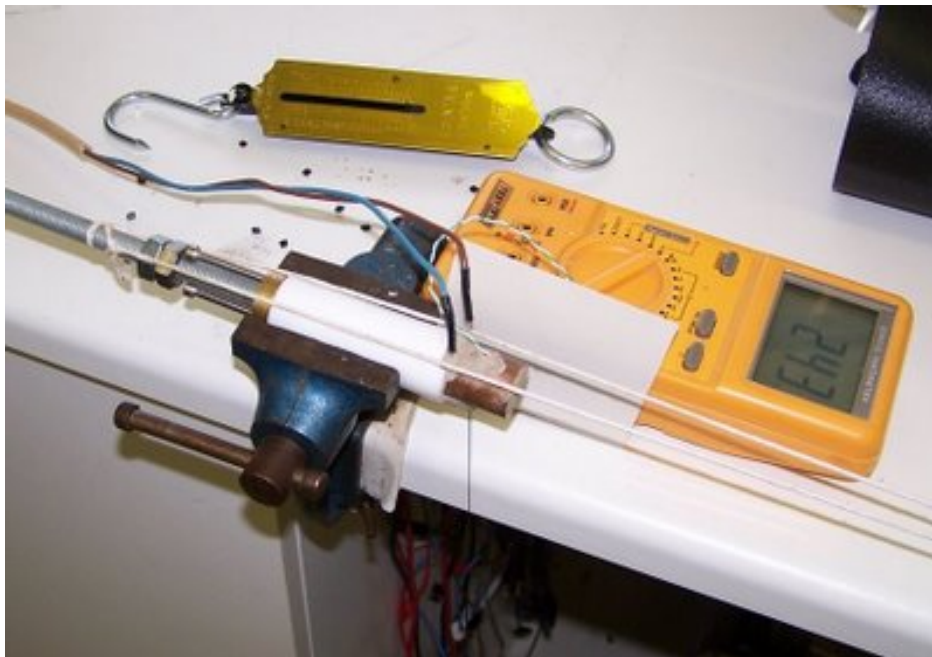

Here's my latest attempt held in a vice under test. It's a PTFE tube with a 10 mm hole down the middle containing the granules. At the left end a brass plate is (very securely) attached by being screwed in and then held with extra screws, which you can see projecting to the left. (Also note the the solid-state force transducer near the top of the picture...)

A length of M10 threaded rod is pushing against the granules in the PTFE tube and being dragged to the right by the string tied to it.

At the right end is a heated brass chamber where the granules melt and are then extruded. This has a nichrome heater embedded in fire cement with a copper tube round that for mechanical strength. The nichrome is 6 ohms, which is a bit high - it'll just about get to full temperature at 12v, but there's no leeway; the next one I do I'll make 4 ohms. The green and white wires are a K-type thermocouple.

Here it is extruding:



This is running at 243 °C. To get the same flow rate as on my conventional RepRap Extruder at the same temperature I had to hang 17 kg on the string - a force of 167 N. The flow seemed very smooth and even under constant load and - equally importantly - seemed to stop pretty quickly when I lifted the load off. As you can see, I've run the extrude nozzle off sideways so that the main axis of the device is horizontal. This reduces heat convection from the hot end to the cold end, thus keeping the granules at the cold end from melting.

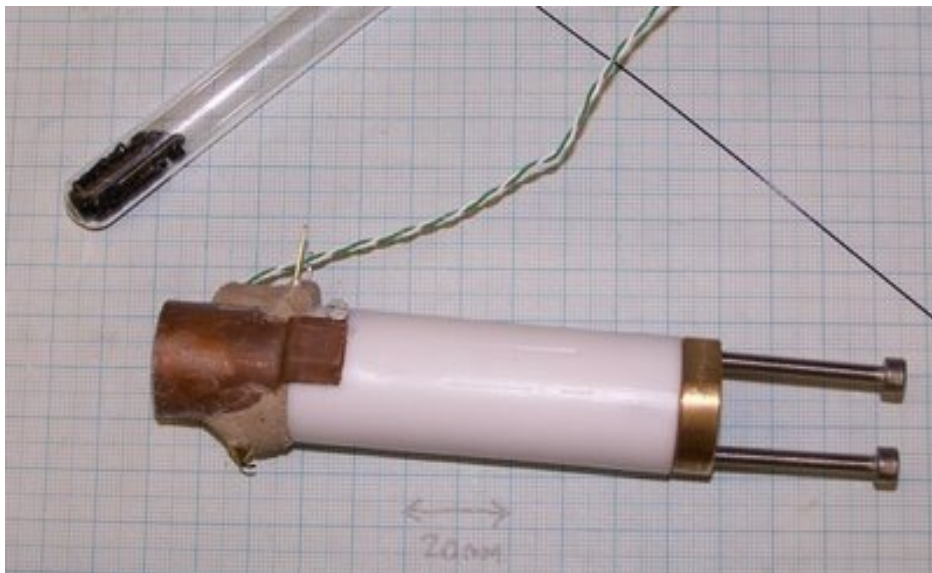

Here's a close up of the device with some of the extrudate it made. The test tube (10 mm internal diameter) contains the granules that didn't melt ahead of the screw. I tipped these out at the end of the test. They form a buffer between the melt and the screw, and mean that it should be easy to withdraw the screw and recharge the device with more granules when the screw has moved inwards to the end of its travel.

Now to design a hopper, a motor drive for the screw, and a force transducer for it to push on so we can control the flow rate...

Another approach to heating the print surface

Sunday, 30th November 2008 by Forrest Higgs

In which the adventures of your narrator in his quest to create a heated print surface are related...

The more I thought about the way that Metalab was heating their printing surface, the more problems I saw with the approach. The most important one, in my opinion, was the amperage requirement that heating a 12x12 inch working surface with 12v electricity would entail. Roughly, we are looking at 150 Watts to heat a 12x12 inch surface. That works out to about 12-13 amps of 12v power.

Yesterday, it occurred to me that one might well achieve more or less the same effect by using a conventional IR heating bulb instead of a nichrome heater between two heat resistant layers with a copper printing surface. This morning I acquired a 150 Watt IR bulb from my hardware stockist and decided to see what was implied by using this approach.

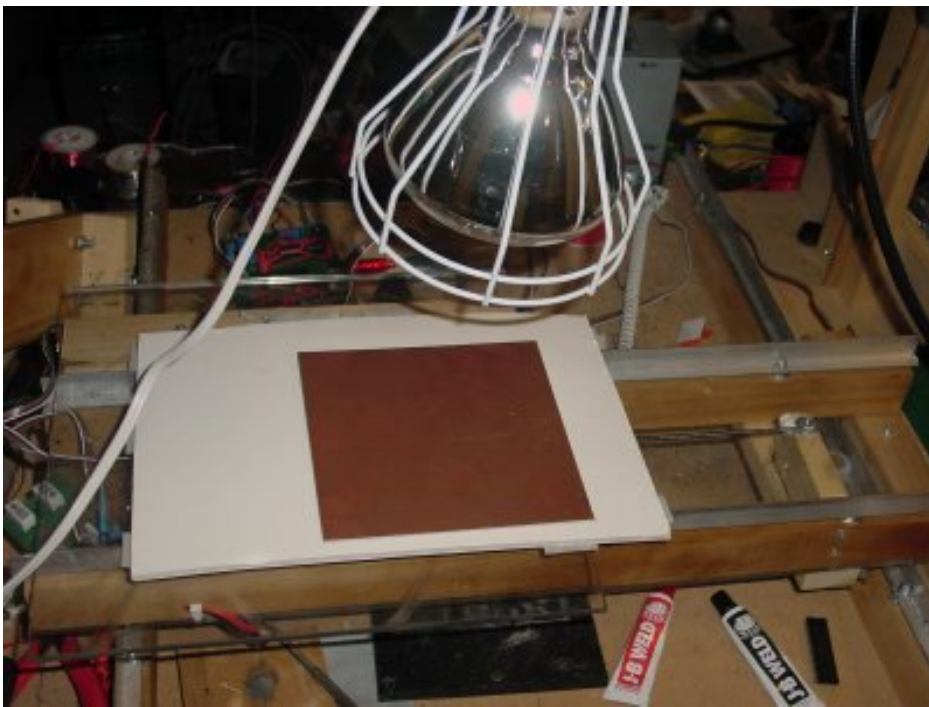

I bought a standard cage holder for the rather fragile IR bulb and used the clamp to attach it to Tommelise's gantry with no problem at all.

My first experiment was to simply turn it on and focus it on a 6x6 inch single-sided printed surface board that I had in stock. I put down a piece of foamboard to keep the xy printing table from heating up and then laid the printed circuit board copper side up on top of it.

As I expected, the emissivity of the copper was very low. While the air temperature in my flat was running 20-21 C I was unable to get the copper to reach much more than 27 C measured from the top. . The IR radiation was not only reflecting off of the copper, but it was doing so in a highly

specular manner as well. If I aligned my IR thermometer so that it saw the reflection of the bulb itself, I saw temperatures of 100-110 C. If I changed the alignment a few degrees, the temperature dropped down to 27 C again.

An interesting aspect which, in retrospect was obvious, was that what the copper side of the printed circuit board was seeing, vis a vis radiation, was the surface of the IR bulb, not the filament or anything like that. Thus, the surface of the bulb pretty much stabilized at about 110-120 and the center of the printed circuit board stabilized at about 100-105. It is worth noting that when I rapidly flipped the board and measured the temperature of the fiberglass-epoxy backside the temperature at no time exceeded 32 C.

It seems that Metalab was able to achieve their temperatures pretty much as a result of the low emissivity of their copper-sided pcb's.

At that point, I recalled that several developers had talked about printing onto HDPE sheets. I decided to try that in that I had a lot of quarter inch 12x12 inch sheets of black HDPE. That exercise gave me a result that made sense as well, in retrospect at least.

Focussing the IR lamp on the HDPE sheet resulted in a slow warming of the center of the sheet. After about 20 minutes the center of the sheet was measuring 105 C while the edges were running about 40 C. The unexpected result was that the differential heating created a substantially raised dome of HDPE in the middle of the sheet. This photo was taken a few minutes after the sheet was removed from the xy print table.

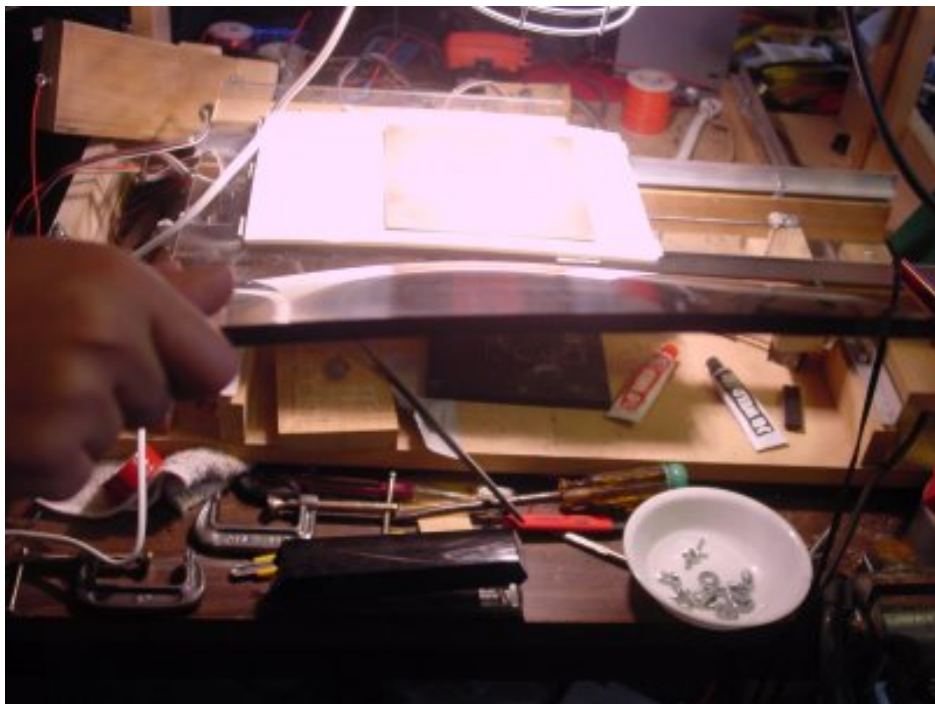

The degree of warping is quite clear in the photo. While the temperature on the top side ran 105 C

the temperature of the bottom side read 80 C. Cooling off the sheet with tap water returned the sheet to its original state in a matter of moment.

Several things can be taken from the exercises.

- the surface on which we print needs to be insulated underneath
- the surface needs to have very good conductivity in order for the heat to spread laterally
- a high emissivity would be nice as well as a diffuse, rather than specular, response to directed IR radiation.

Another thing that might be useful is to not use IR bulbs but rather use a radiant coil, so that a much higher radiant temperature could be achieved. The glass face of the IR bulbs kept the temperature from getting much above 110 C for the wattage used.

Solid Model files for Darwin's Cartesian Bot

Thursday, 4th December 2008 by eD

The latest release of the Cartesian Bot files (1.0.6) are now available on [SourceForge](#). This release includes assembly and part models in STEP and SolidEdge (v19, Academic Licence) formats, as well as the STL files.

Building a printable stepper for a next generation

Tommelise

Friday, 5th December 2008 by Forrest Higgs

In which your narrator gets down to cases in the quest to design and build a more or less printable stepper motor...

Back in July I started [a project to build a tin can linear stepper motor](#) for my next generation Reprap machine, Tommelise 3.0. Before I went on to other projects I established that it ought to be technically feasible. I had two motives for wanting to do this

- to increase the percentage of a Reprap machine that it could build
- to get around the pig-headedness of the Chinese engineers who were refusing to sell me lead screws for their very inexpensive (~\$2.50) linear stepper motors in the lengths I needed

I bought the original linear stepper motors for Tommelise 2.0 from [Haydon](#). While their product massively simplifies the design and construction of accurate positioning robots, their pricing structure obviously factors that ease in to the point where a Haydon linear stepper and lead screw costs about \$80/axis. The Chinese were much more attractive, pricewise. Unfortunately, they had had some customer complaints about the tendency of their small diameter lead screws to bend under load. While I tried to explain that I wasn't using their linear steppers to anything like their design loads, they still flatly refused to sell me the lead screws in the 12-18 inch lengths that I needed.

Having lived in China and liking the Chinese people immensely, I was altogether shocked and finally angered at this situation. In the months since July this annoyance began to inform my efforts at building a printable tin can linear stepper. The big problem with making a tin can linear stepper lies in the rotor. If you go for a one for one match you have to have an aluminum spindle and coat it with either a polymer or epoxy layer with an admixture of magnetic media. While this isn't technically a really difficult problem, you then have to create a special gaussing device to create the alternating magnetic stripes of opposite polarity on the rotor.

I came up with an alternative design which used thin steel strips and a ring magnet to simplify this process. There were two problems with my solution. First, the retail price of the ring magnets was on the order of several dollars. Second, and more importantly in terms of my annoyance with Chinese suppliers, was the fact that the Chinese these days pretty much make ALL of the rare earth magnets in the world. This situation has got to the point that the GPS guided bombs that the US uses to pound terrorists use Chinese magnets. Finally, I discovered that the nickle plating that the Chinese put on their rare earth magnets perishes after a few years leaving you with a really nasty mess where your magnet used to be.

All this kept me from continuing the effort I'd started to build a linear tin can stepper. A few days ago, however, I ran across what began to look like a much more suitable alternative. While, I'd

read about variable reluctance steppers in a variety of stepper references, I hadn't really run across one in practice. Recently, however, I was nosing around in the Reprap forums "Things to Print" section, a place that I rarely visit. Back in May, Tim Atwood came up with a [printable variable reluctance stepper](#), although he doesn't quite call it that.

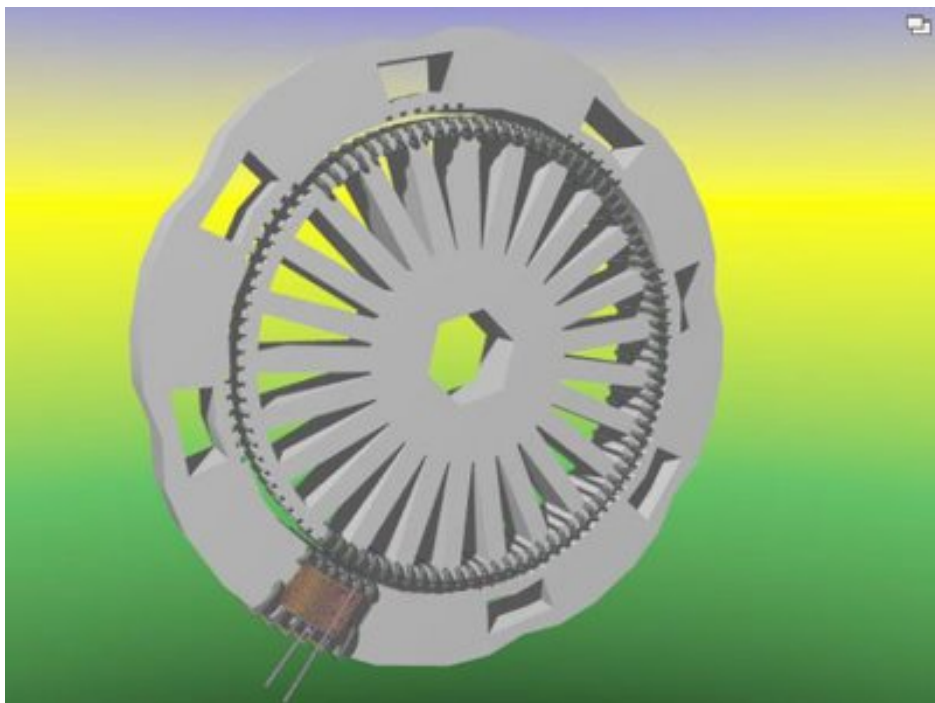

While Tim was aiming at producing a stepper with a very small step angle, the Tommelise approach needed nothing this complicated. What really got me moving, however, was what [this little project](#).

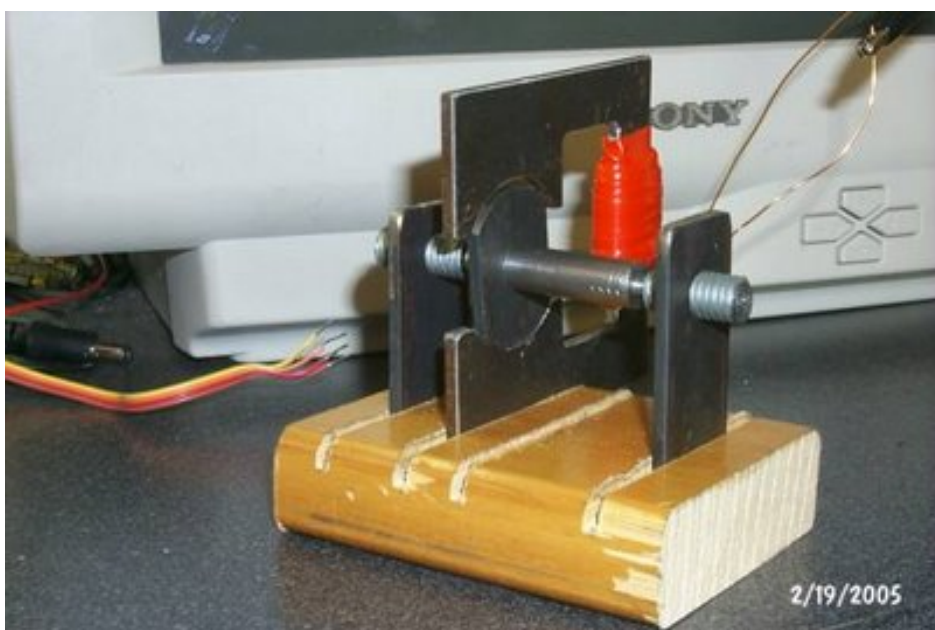

The motor you see is a one phase variable reluctance motor. As you can see in the video it is a bit of a pig to get started and keep going. Watching its inventor work with it, however, I was

reminded of [an illustration I'd seen some time ago](#).

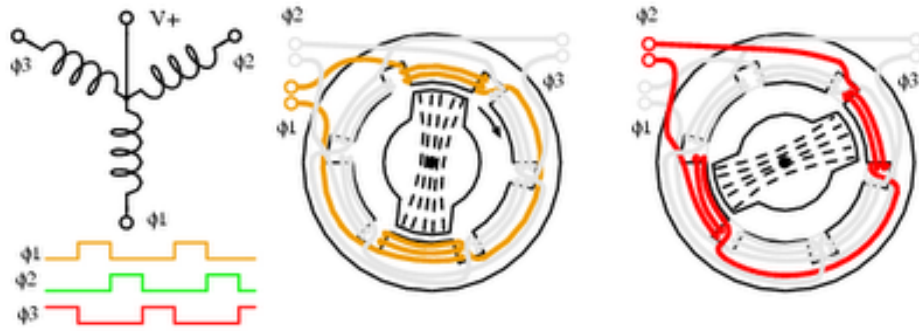

While this design had a 60 degree angle step, I could get it to give me 30 degrees by either half-stepping it or using a cruciform configuration rotor rather than a simple bar rotor.

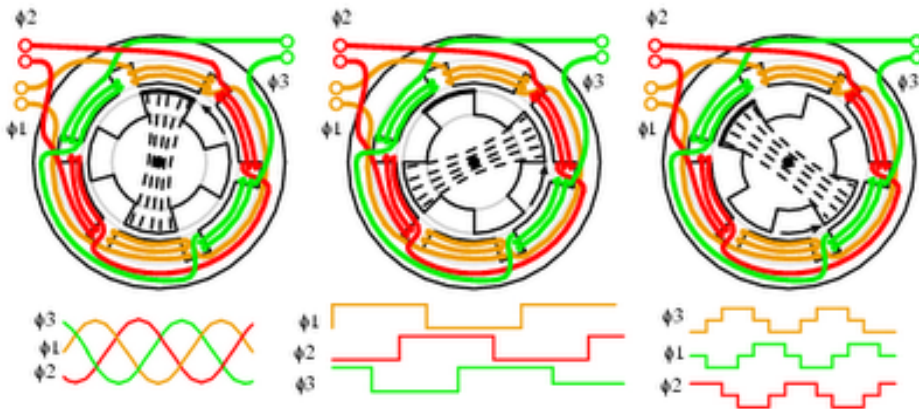

Further, if I used the general design of the single phase variable reluctance project that twiggled my imagination, I could reduce the complexity of the fabrication dramatically.

With all that in mind, I dug out [Rick Hoadley's Excel app](#) for designing electromagnetic coils and had a go at designing a coil for a first cut at such a stepper out of stuff that I had at hand.

Electromagnet Design										
ALL DIMENSIONS ARE IN INCHES										
Coil Data		for max gauss								
core radius	r1	0.25	inches	0.25						
core diameter	B	0.5		0.5						
outer radius	r2	0.5		0.75	r2=3*r1					
coil diameter	D	1		1.5						
coil thickness	N	0.25		0.5						
core length	L	0.5		1	L=4*r1					
Wire Data		awg	dia	nom dia	turns/in	turns/sq in	Ohms/1000'	Current	Fusing	lb/1000'
wire size, enamel		28	0.01264	0.01360	85.44	4282.0	64.89	0.16	14.50	0.48
number of turns/layer	t		32.7		36.8	max				
number of layers	y		16.4		18.4	max				
total number of turns	T		535.3	turns	675.8	max				
total length	x		1180.2	inches	98.4	feet		0.05	lb	
total resistance	R		6.382	Ohms						
applied Vdc	V		5.4	Volts						
rated current	I		0.85	Amps		I ² *R	4.6	Watts		
amp*turns			453			surface area	1.57	sq in		
						dissipation	2.91	W/sq in	0.5	ideal
Gauss at center	G1		252	Gauss		(center of air core)				
	G2		179	Gauss		(center of edge of air core)				
	G3		74	Gauss		(inches from RH edge of air core)				
	at		0.25	inches from RH edge						
Inductance with air core	L		3.7	mH		Coil				

This was a nice little coil. I got considerably better gauss ratings than my linear steppers gave me and kept the amperage down to something manageable. The only worry I had was that I was generating 2.91 watts/square inch of heat to dissipate while Rick suggested that 0.5 was ideal. I had no idea what "ideal" meant when Rick used the term.

So... I built the coil. The spool for it was made from two nylon sleeves epoxied together.

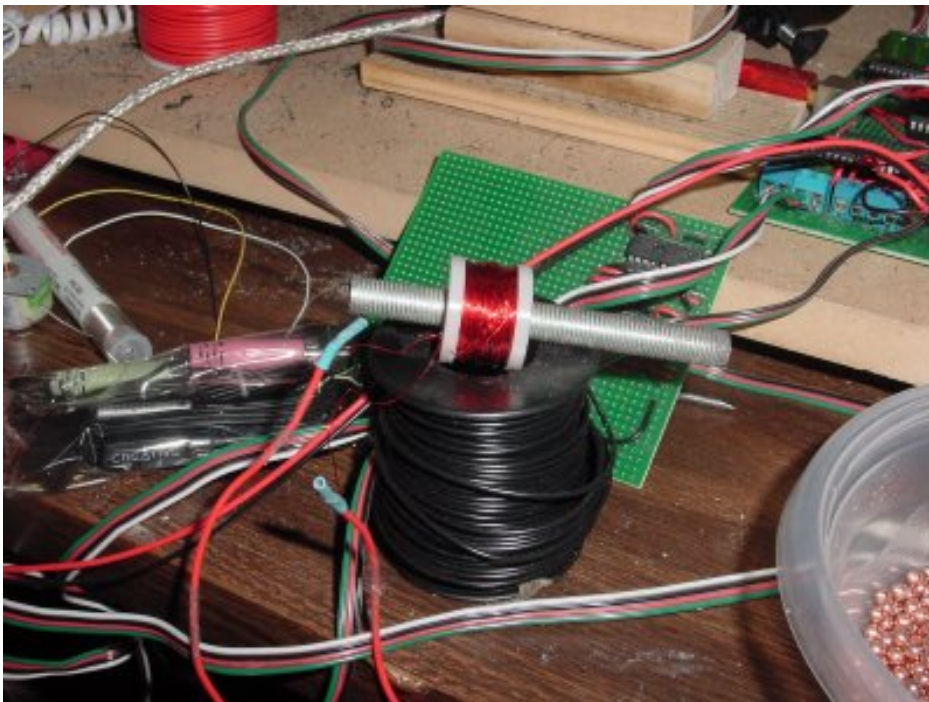

To give you an idea of scale, that's a piece of 3/8ths inch threaded rod running through it. I pulled 5.4 and 12.2 volt power off of my ATX power supply. When I ran it at 12.2 v, it got quite hot within

a few moments. I monitored the coil's surface temperature and shut it down when it nosed over 100 C.

I then applied 5.4 volt power. At that level the coil stabilised at about 71-72 C, hot, but not outrageously so. Apparently Rick's "ideal" dissipation rate heats the coil to only a few degrees above ambient.

[Rick also mentioned another little game you could play with your electromagnet.](#) The game was to see how many steel BBs (4.5 mm copper washed steel pellets used in American air guns) your electromagnet could pick up. Although Rick didn't mention it, it struck me that the number of BBs a magnet could pick up may be directly related to it's gauss rating. I had a go with this.

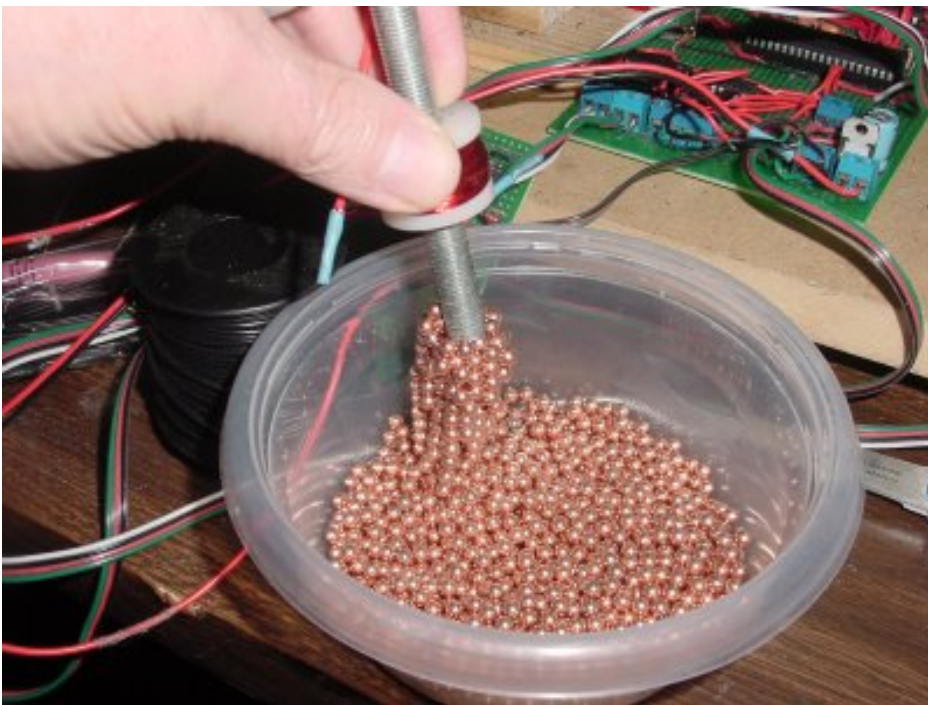

The only trick to this experiment is that to lift the maximum number of BBs you have to be very careful. Also, if you lose power before you get your BBs from the dish to another container things can get a little messy. In fact, though, I discovered that the pickup power of the electromagnet related to the gauss level predicted by Rick's Excel sheet such that...

1 gauss = 1.8 BBs

One end of my electromagnet would pick up 42 grams of BBs at 5.4 v.

I'm quite excited about going forward with my variable reluctance stepper motor project. Freescale described this class of motor in these terms.

The reluctance motor, commonly referred to as either a variable or switch reluctance (VR or SR), offers the simplest, lowest cost motor available to date. This motor consists of a shaped, highly permeable material for the rotor and two- or more-phase windings in the stator. The shape of the

rotor concentrates magnetic flux lines into "poles" on the rotor which then interact with the rotating field being developed in the stator windings. The VR and SR motors must be electronically controlled to start turning and to produce the torque needed to continue rotation. Torque pulsations generated by this design tend to produce undesirable audible noise, leaving much research still to be performed. The potential for its low-cost application into many areas, however, makes it an extremely desirable motor to use in a broad range of products.

This looks promising.

No-curl hair dryer

Thursday, 11th December 2008 by Adrian Bowyer

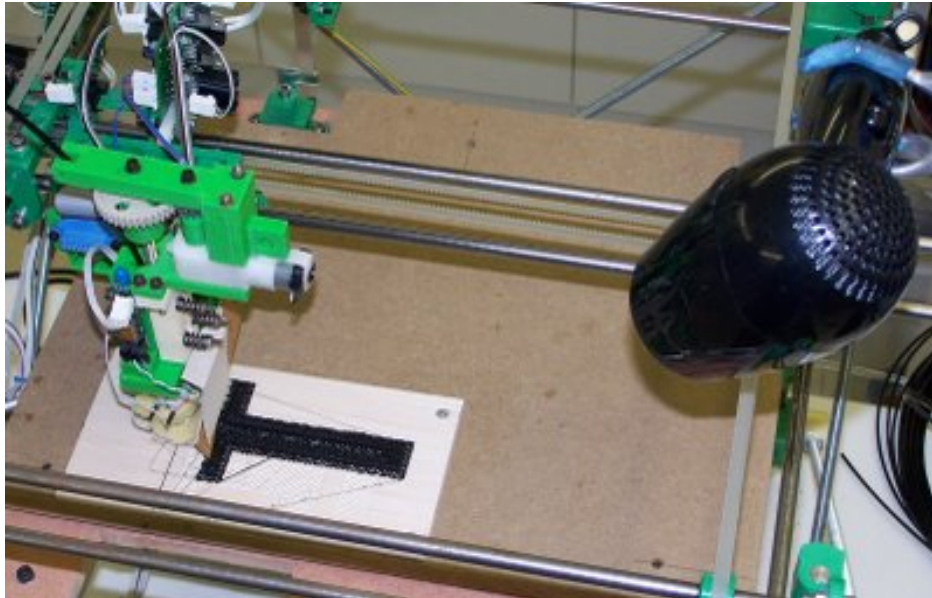

ABS is a superb building polymer, but it does tend to curl up and delaminate as it's laid down because of thermal contraction. Inspired by Nophead's work and the [heated base done by Metalab](#), I decided to try a very simple solution. I ran a build with a cheap hair-dryer (right) clamped above my RepRap machine blowing on the build.

The result was perfect: there was no curl at all; the part built as flat as a pancake.

I had to insulate the extruder head by wrapping it in fibreglass wool and putting a piece of cardboard on to exclude the draft: the hot air cooled it too much...

The head was running at 240 °C. I put a thermocouple thermometer on the base at various locations around the build as it progressed. The result was a pretty constant 60 °C. Measuring the temperature of the part during the build with an IR thermometer gave 70 °C. Measuring the components of the extruder (including the motor) gave temperatures just below 40 °C; I directed the hair-dryer carefully to minimise the flow of hot air over them and the electronics.

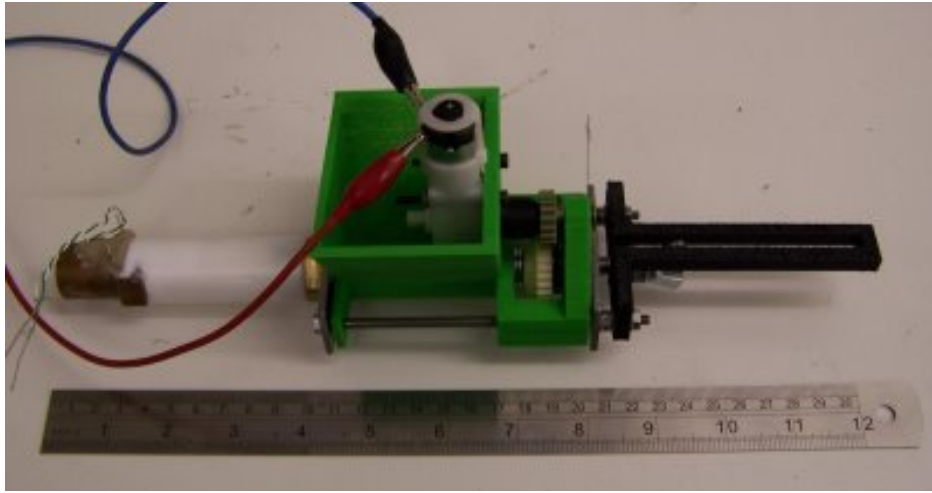

And here is the part fitted (right). This is the prototype granule extruder coming together. The part is the guide that stops the screw-drive rotating as it's driven against the polymer granules. I made the hopper (green) in the Strat as my RepRap was in bits the day after I'd finished the design for that.

Watch this space...

Chemically grinding ABS scrap: part 2

Thursday, 11th December 2008 by Forrest Higgs

In which your narrator [continues his efforts](#) to get something for Adrian to put in his granule extruder...

This time I prepared 5 cm³ of ABS from 3 mm filament by cutting it into 4-5 mm bits



To this I added 20 cm³ of pure acetone at room temperature (~18-20 degrees C).



After about an hour with periodic stirring to keep the softening bits from sticking to the bottom of the container about 20-30% of the ABS was dissolved.

At that point I put the jar in a water bath 43 degrees C. (~110 F). Raising the solvent temperature allowed the rest of the ABS to dissolve within another 20 minutes. Thus, at this point, I know that I can dissolve ABS in pure acetone in volumetric proportions of 1:4. I expect that it would be possible to improve on this. The limiting factor seems to be the need to wet the pieces of ABS with acetone more than anything.

When I decanted the ABS dissolved in acetone in the previous experiments I skimmed the floating precepitate off the water and was able to filter it quite easily with an ordinary coffee filter. Unfortunately, I soon discovered that much and possibly most of the precipitate was heavier than water and settled, over a period of days to the bottom of the water.

As a result of that, this time I simply filtered the whole water/acetone mix through the coffee filter so as to get all of the ABS precipitate instead of just the lighter fraction. While the light fraction of ABS did not jam the coffee filter, apparently the heavier fraction was of a fine enough grain size that it did and I had extreme difficulty using the filter to separate water and ABS precipitate.

Cleaning the filter several times and changing it once did allow me to recover all of the precipitate eventually. I know now, however, that coffee filters aren't going to be a practical way of recovering the ABS. I'm beginning to think that some minaturised variation on a [spray drier](#) is going to be needed in which we can skip the need to precipitate the ABS in water.

Ponoko Lasercut RepRap BoM

Sunday, 14th December 2008 by Vik Olliver



Image not found.

Russ Nelson has kindly compiled a Bill of Materials for the Ponoko lasercut RepRap. He did this with a markup language that is integrated into the web pages themselves, allowing him to pull the BoM out automatically for any web page using the same markup scheme.

For example, two M5 washers would be described in the wiki page as:

```
<part p="two M5">washer</part>
```

I am also able to offer a 50% discount on Ponoko's cutting costs to RepRappers. They currently have the V1.1 design available here but it has the words "Safe area" printed over the parts and I can't change it because a run is in progress. However the source files are in my user RepRap directory on SourceForge, and I can cut unblemished ones.

Ralith is testing out the new 3.5mm ball-chain gears from V1.1 because the old design frankly didn't work. But the 3.3mm ones are just fine.



Image not found.

There is also a single RepRap extruder design available, containing just one extruder and a selection of gears for various motors.

If you want the discount, get hold of either suz or vik at the diamondage.co.nz e-mail address and

we'll set it up for you.

Finally, there is a #reprap channel on freenode.net where a lot of real-time assistance can be had, and the RepRap Project has applied for stewardship of it. If you've not used IRC before, the best way is probably a Firefox browser add-on called Chatzilla.

Vik :v)

Paste extruder motor test

Friday, 19th December 2008 by eD

I wanted to find out which motor lends itself best to a paste extruder design. I came up with some rough prototypes and pitted Fab@Home's non-captive stepper from Haydon (left) against our old favourite, the Solarbotic GM3 servo (right).

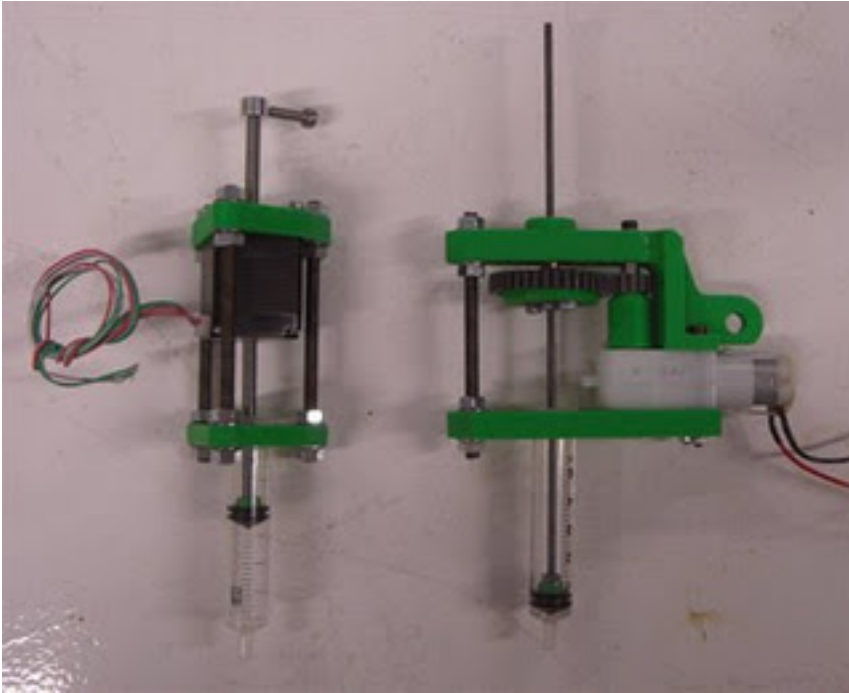

Both designs worked great, however, the non-captive stepper design was radically simpler with significantly less fiddle and faff (hats off to Evan from F@H for going with this principle). Unfortunately, this particular non-captive stepper (Haydon, 28000 series) is worth \$100+, and with cost of the RepRap an ever-pressing issue, we are investigating cheaper non-captive alternatives. From the design point of view non-captive is the answer. Could we make the GM3 non-captive?

Adrian demonstrated a great hack to convert a captive stepper into a non-captive by boring a clearance hole into the shaft and leaving an internal thread on the last few millimeters:

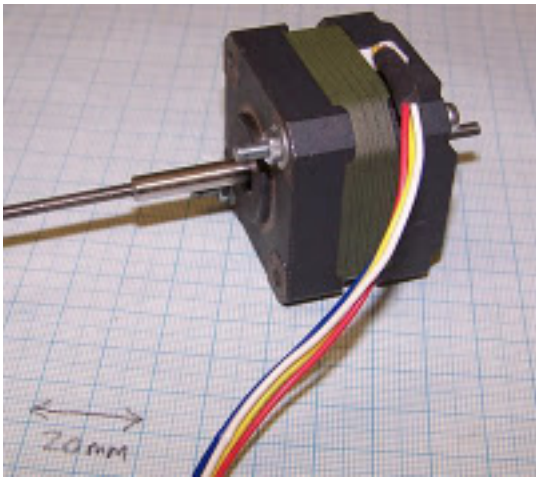

Investigations continue...

Well. That didn't work...

Friday, 19th December 2008 by Adrian Bowyer

That being this - my attempt to make a granule extruder. It worked perfectly *first time*, but - after it had cooled and then re-heated for a second run - the plug of solidified polymer wouldn't shift, regardless of how much welly I gave the motor. Nophead had the same problem when he tried this, but I thought my use of PTFE might have fixed it. No such luck.

So.

Back to the drawing board.

It was too big anyway.

This is my new vertical design based - as you can see - on the existing filament extruder drive and motor (M). The nozzle and PTFE arrangement (N) at the bottom are the same as the current extruder too, except the internal diameter is 4mm.

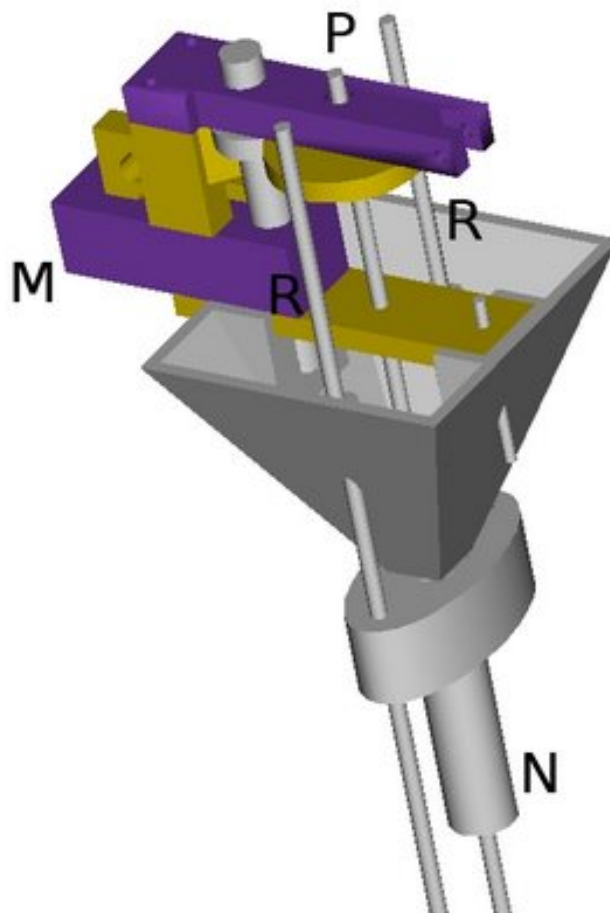

It'll need smaller granules than standard (about 1mm). But we also need to make a recycling shredder anyway, and Forrest has been getting interesting results with ABS precipitation to make powder.

The central rod is M4 and is driven down by the larger gear, forcing granules into the PTFE. The mechanics are essentially the same as the previous design, so we have halved the radius and thus increased the pressure by a factor of 4. That should, I hope, shift the frozen plug and get the thing started.

As before, all the force is taken by the rods (R) to a plate at (P) (not shown). All the pyramid hopper and central arrangement floats on those rods and sees no force, though the extrusion force will be considerable.

To the machine...



Bother! I made this using the hairdryer trick, and you can see the delamination top right. This proves that the hairdryer works really well to prevent this - that was the only corner to grow out of the hairdryer flow, and the only corner not to build smoothly.

Serves me right for leaving it running while I drove into the university for a meeting with eD. Fortunately the part is usable - I'll just cyanoacrylate it in a vice and it'll be good as new.

Sticking point

Sunday, 21st December 2008 by nophead

sid, who is a regular contributor to the RepRap forums, had an idea to get a soldering iron manufacturer to make a heater barrel assembly for RepRap. He approached a Chinese company with a specification and they sent him some prototypes. He forwarded one to me for testing. It appears that they ignored his specification and just sent a standard de-soldering iron element. Nevertheless it is a nice unit and looks eminently usable.



It works perfectly apart from one fatal flaw, full details in my [blog](#).

Non-captive Gearmotor

Sunday, 21st December 2008 by Steve DeGroof

There was some discussion in [this post](#) regarding hacking a GM3 into a non-captive motor. Partly out of curiosity but mostly out of bloody-minded stubbornness, I decided to give it a shot. I couldn't find a spare GM3 but I had a GM17 lying around. It, like the GM3, has a coaxial pinion on its shaft.

Turns out it's possible to drill right through both. A 1/8" bit makes a hole big enough for an M3 screw but small enough not to ruin the pinion. I took apart the motor, removed the steel axle and drilled out the gears.

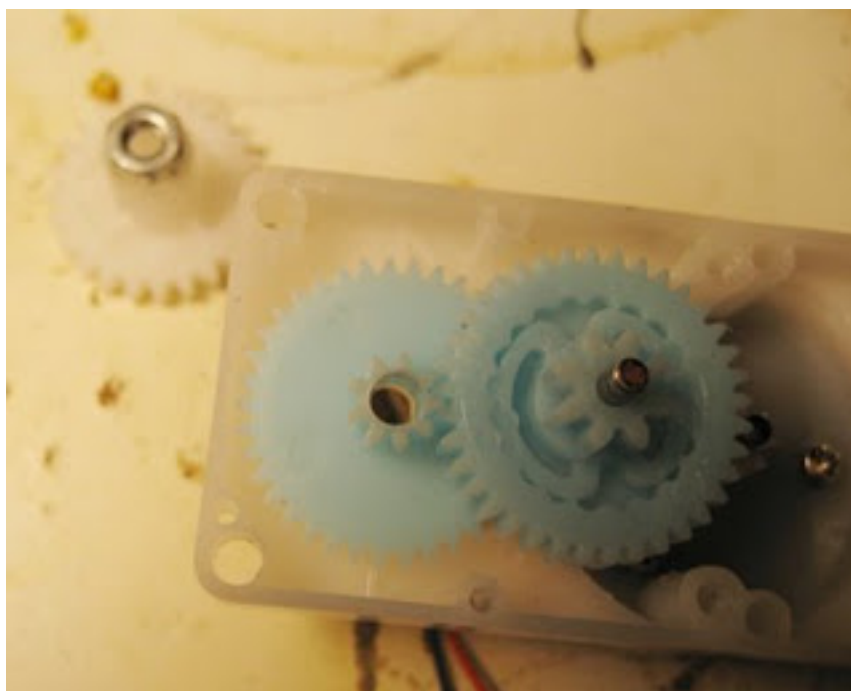

I put an M3 screw in place of the axle, glued an M3 nut onto the shaft and reassembled the motor.

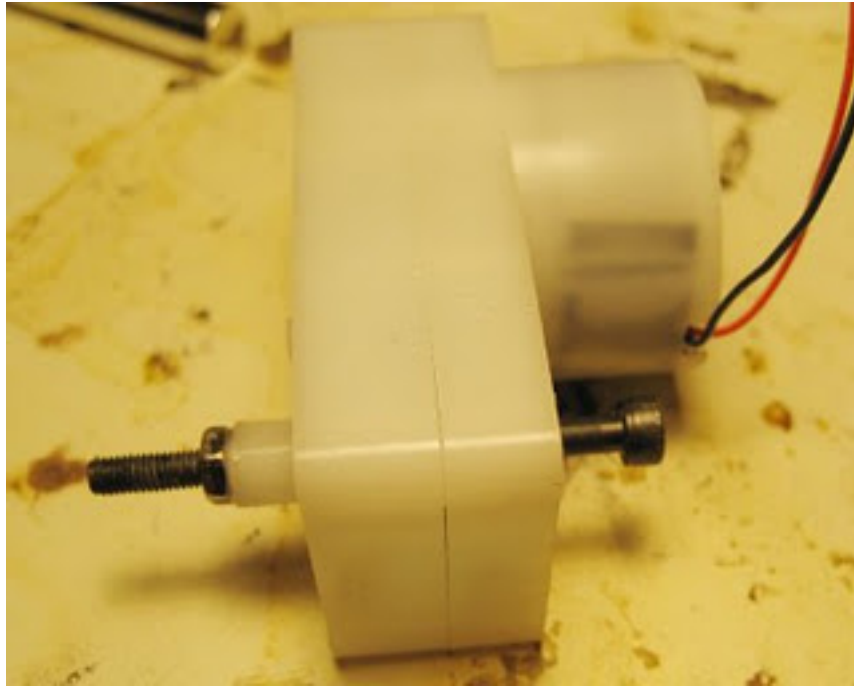

I doubt the glue would take much torque. Need a much more solid connection. The M3 screw ends up acting as an axle for two gears rotating at different speeds. No idea what kind of wear that will produce.

On the other hand, the screw does move back and forth just like you'd expect, as long as you keep it from rotating.

UPDATE: Here's a shot of the same motor pulling 3mm ABS directly. The GM17 doesn't seem all that powerful but it was able to pull the filament fairly well. Oddly enough, it was relatively easy to keep the filament from turning, just by holding it in a gentle 90 degree bend (say, 15cm radius).



Roast-in-a-bag Duck...

Monday, 22nd December 2008 by Adrian Bowyer

...tape.

The hair dryer works remarkably well as a means of creating a constant warm environment for building with ABS. This prevents both curling and delamination. But it can be a bit hit-or-miss, and is also noisy and uses a silly amount of power (1.4 kW according to its rating plate, or - to put it another way - over 20 times as much as the whole of the rest of the RepRap machine...).



Forrest had a brilliant idea: use an oven roasting bag to enclose the build in a bubble of warm air. So, from a suggestion by Nophead, I built a miniature fan convector (above). It's an old processor heatsink and fan with two 10-ohm pieces of nichrome wire woven in among the heatsink fins. They're in parallel, and at 12v will give about 30 W. As an alternative you could obviously just bolt a fat 4.7-ohm resistor on the back.



Then I phoned Christine and Sally (w. and d.; they were out buying things for some sort of festival that they claim is imminent; I think they're trying to pull the financial wool over my eyes...) and asked them also to buy oven bags. I bolted a sheet of balsa (previously used to build on) just under the extruder mechanics and duck-taped the bag to it and to the build base.

I moved the machine about to make sure there was enough slack to accommodate a build. This was a bit tricky, as too much and folds would have got in the way.

The cream object to the right of the picture is a thermometer. With both the extruder on and the mini fan convector the temperature in the bag stayed pretty constant in the top sixties.

I ran a test build:

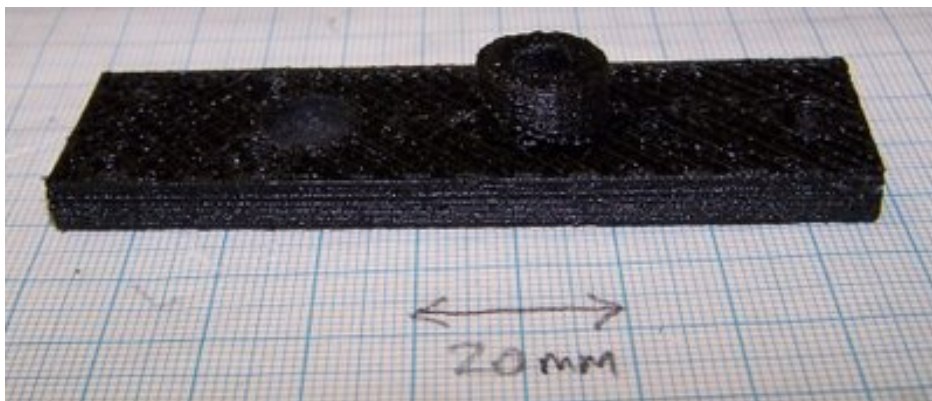

Another part of the newest granule extruder. Holding a rule against its base and squinting at the light in any gaps reveals it to be as flat as a pancake in Flatland.

Clearly the bag arrangement could be considerably tidied-up with the addition of some concertina folds and springs and so on. I don't know what polymer they use, but the extrude head (internal temperature 240 °C) came to rest against it several times and didn't cause any damage at all.

A rather good side effect was that the slightly acrid smell of molten ABS was completely enclosed and thus eliminated. Even when I opened the bag at the end no smell emerged, implying that the volatiles had condensed inside.

Mother of all Boards...

Wednesday, 24th December 2008 by Adrian Bowyer

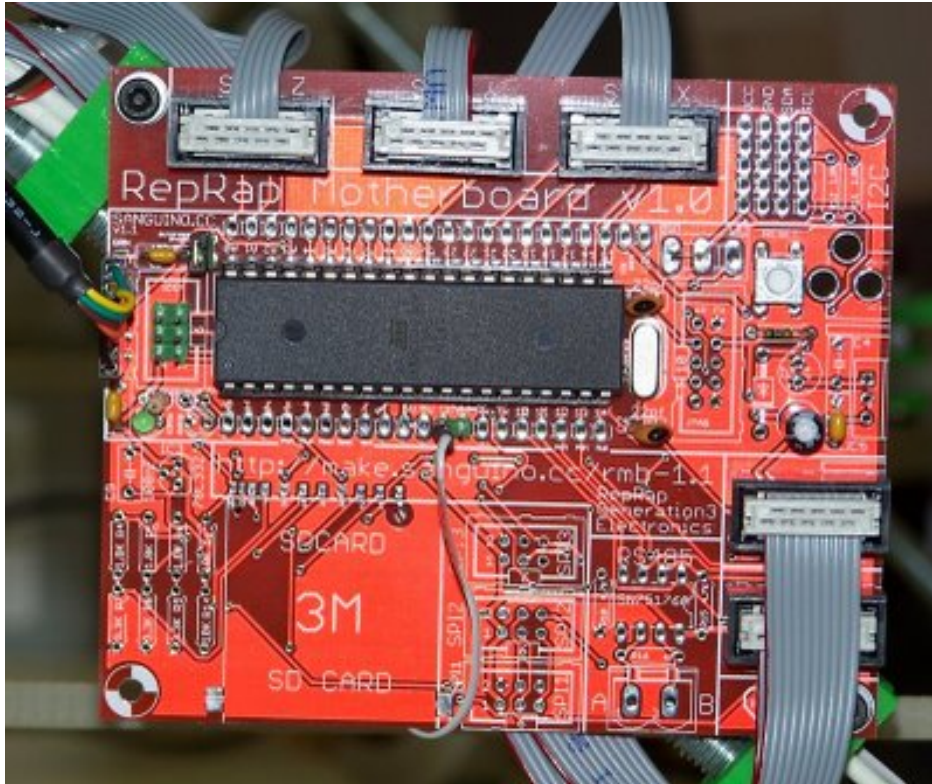

Zach kindly let me have a prototype of his latest Sanguino board. I've just installed it on my RepRap (above) and it runs just fine.

The Sanguino is great as a RepRap controller, and I have been using one on my machine for months. But Zach rightly designed it as a general microcontroller with RepRap as one application, not specifically for RepRap.

He has now used the Sanguino as the basis of a dedicated RepRap motherboard, which is what is in the picture above. This has insulation-displacement connectors on for wiring to all the RepRap Generation 2 electronics, which makes it really quick and easy to hook up.

In addition, it has the components that will allow us to move to the Generation 3 Electronics, which will be needed for RepRap Version II "Mendel" sometime next year. Those extras are an SD card socket, which will allow an SD card with a G Gode file to be plugged in and run on the machine, so the RepRap doesn't need to be attached to a host computer to build things. It will also have RS485 communications to allow it to control an expanding number of other PCBs, particularly for multiple extruders and hence multiple materials.

As you can see, I haven't populated the board very fully. This was deliberate: I wanted to set up a

minimal-Sanguino-to-control-a-RepRap configuration. For that you need (on the new Motherboard or a conventional Sanguino):

1. C5
2. C6
3. SV1
4. C8
5. JP8
6. R1
7. S1
8. C1
9. C2
10. Q1
11. C3
12. JP5
13. IC1

And you can also have the unnecessary but useful power indicator (hang the expense):

1. R2
2. power LED

On the new motherboard you also need:

1. SV3
2. SV4
3. SV5
4. SV6
5. SV7

That's enough. Off to wrap presents now...

IRC Chat Now Has An Archived Log

Friday, 9th January 2009 by Vik Olliver



Matt Chan has kindly set up a logging daemon, so we now have an IRC chat archiver!
All messages sent to the #reprap channel on freenet.org will be recorded and archived online at <http://mattchan.homelinux.net:55555/reprap/>.

The bot is an eggdrop client (<http://www.eggheads.org/>) running on a CentOS 5.2 server. More features are expected in the coming weeks.

If you have the [Chatzilla plugin](#) installed, just click on <irc://irc.freenode.net/#reprap> to join in the realtime chat on all things RepRap.

Vik :v)

[No Title]

Saturday, 10th January 2009 by Zach Smith



We've been using GM3 gearmotors for our RepRap extruder motors, but they have a few problems (most notably being underpowered and having cheap plastic gears) so I decided to shop around and try to find a motor that I could be proud of. I stumbled onto the site kysanelectronics.com and ordered a bunch of their 12v DC gear motors. I got about 10 different motors with various gear ratios, sizes, etc. I decided to sacrifice one and take it apart. Turns out I was actually (miraculously?) able to piece it back together again, in working order too!

Here is a [flickr set](#) with the teardown.

Anyway, here are a few observations about these motors:

- * they are all-metal construction (gears, housing, shafts, etc) the only plastic was an insulator on the terminals
- * they are very powerful (my test is attaching vice grips and letting them rotate the vice grips, then trying to stop the rotating pliers with my hands. all could easily move the pliers, and most took a decent amount of force to stop)
- * they are pretty cheap! for a single motor, they are \$9.07 for a single unit and at volumes of 100+ they drop to \$7.34. Not as cheap as the GM3, but they have dramatically higher strength, etc.

I think I may just have to place an order for a hundred of them. =)

Pinch Wheel Extruder Prototype

Monday, 12th January 2009 by Zach Smith

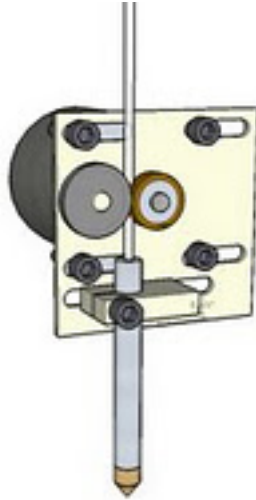

Ever since reading [Lou Amadio's blog entry](#) on an idea for a pinch-wheel extruder, I've had the idea stuck in my head. One of the consistent problems I've had with building a RepRap has been the extruder mechanism: its either super complicated, needs machined parts, or usually a combination of both. When I saw the simplicity of this design, I instantly loved it. However, I didn't know what motor to use on it, so the idea went into the 'rock tumbler' portion of my brain.

Before even starting a design, I wanted to make sure that it was feasible. Going to a direct drive of the filament means that you need a motor that goes really slow... but how slow? Well, glad you asked. I created a [Google Spreadsheet](#) with formulas relating to filament feedrate. There are three different things I looked at: Driven Screw based extrusion (how things are now), Pinch Wheel Extrusion (what i wanted to experiment with) and finally how the filament feedrate actually translates into extruded filament. Luckily for me, nophead had posted most of the formulas to the reppap mailing list, so I just had to setup the spreadsheet.

So, what did I find out? Pinch wheel extrusion *is* possible, but you need to hit two important criteria: 1) an RPM of 2 or less, and 2) a pinch wheel diameter of less than 15mm, ideally under 12mm. At these numbers, you get 1.26mm/sec of filament extrusion. With a 0.7mm nozzle, you get 23.08mm/sec of extrusion. This is really fast, but thats okay.



This was all just a random rewrap idea in my head until a few days ago, when I got a shipment of DC gearmotors from Kysan. Randomly, I managed to pick up an extremely lucky motor: it is geared down something like 600:1 and thus rotates at 2 RPM. This also means it has a lot of torque. I started on a filament feed prototype yesterday and got a working model.

Unfortunately, the model had some flaws! I really had no idea what to use for the actual pinch wheel. I tried about 5 different things until I found one that worked reliably. I'll list them below so you can learn from my mistakes:

Fail: Acrylic wheel w/ a rubber band glued on. I figured since rubber grips on ABS pretty well, it would work okay. It didn't. It slipped when I applied any sort of 'realistic' force.

Fail: Acrylic 'gear': I tried a variety of lasercut 'gears' with little teeth cut in a variety of profiles. If I didn't push the idler wheel in tightly enough, they would just slip. If I pushed it in too tightly, they just cracked and broke.

Fail: Dremel sanding wheel. I noticed a sanding wheel from a Dremel laying around. It was slightly bigger than the shaft of the motor, so I used a dab of hot glue to attach it to the shaft. I figured that at such low speeds, it would simply grip the filament... which it did. Until it slipped, then it just turned into a super-slow filament sander, lol.

Fail: Tiny belt pulley from McMaster. This pulley wheel was the proper diameter, but the hole to

mount on the motor was too small. I decided to drill it out bigger. Well, I basically destroyed the belt pulley.

Win: Slightly larger belt pulley from McMaster. This pulley wheel had a 1/4" (6.35mm) bore which was just slightly bigger than the 6mm motor shaft. A bit of masking tape to keep it properly aligned and it fit perfectly. It has set screws, so it is **very** firmly attached, especially with one set screw on the flat of the motor shaft. This setup was super strong. I had to use quite a bit of man-force to keep it from pulling the filament in. Seriously awesome.



If you look at [the pictures](#), you can see that the pulley wheel actually imprints its tooth profile onto the plastic, which turns the plastic into a sort of matching gear, giving it some serious grip strength. I think that this is the key to getting a good, solid filament drive. There are a few downsides to the pulley: 1) its slightly too big, but McMaster doesn't sell a smaller pulley with the same bore size. 2) the tooth profile is not very sharp. with a sharper tooth profile, it would probably have a much better grip vs the blunt profile.

I'm very happy with how this design turned out: it has very strong filament output, it is a **super** simple design, and everything except the lasercut parts are things you can buy on McMaster.com (or hardware store)

The next step is to modify the design to mount the heater barrel stuff to it, but that should be easy since the lasercut extruder design by Ian has a really nice design for that already.

Oh, and I need to do 2 other things: 1) modify the design to allow super easy mounting of the magnetic rotary encoder and 2) modify the design to allow super easy mounting of the new extruder controller board, which is in prototype stage right now.

Anyway, if you want to check out the design files, they're up on [Thingiverse](#) or in RepRap subversion in my home directory.

Cheers!

Zach

MiB

Wednesday, 14th January 2009 by Adrian Bowyer

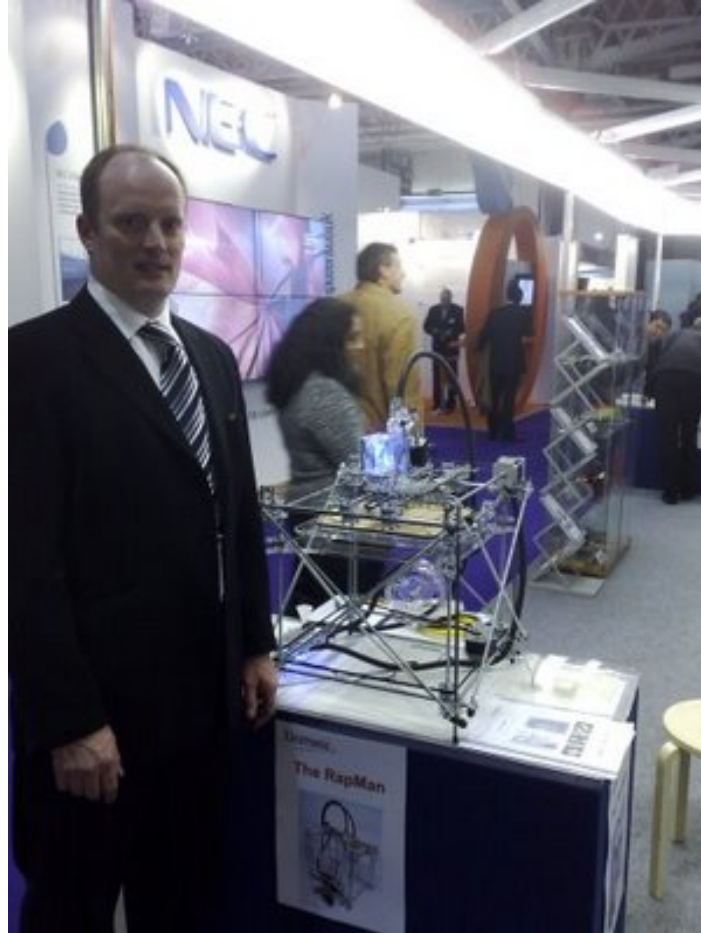

No, not Will Smith, but reprinter Ian Adkins of Bits form Bytes at the BETT 2009 Show at Olympia in London with his latest version of RepRap, which is being sold as a kit into the education market and elsewhere by Unimatic Ltd. It's based on his previous lasercut version but with some neat additions, like a better extruder and a built-in filament reel. It's also driven by PIC32-based electronics that Ian's developed. All designs etc. will be posted online as soon as we get our breath back.

If you're near London why not drop in? It's just up the road from Earls Court tube, or get the special exhibition train to Olympia.

Pinch Wheel Extruder Prototype v1.1

Friday, 16th January 2009 by Zach Smith

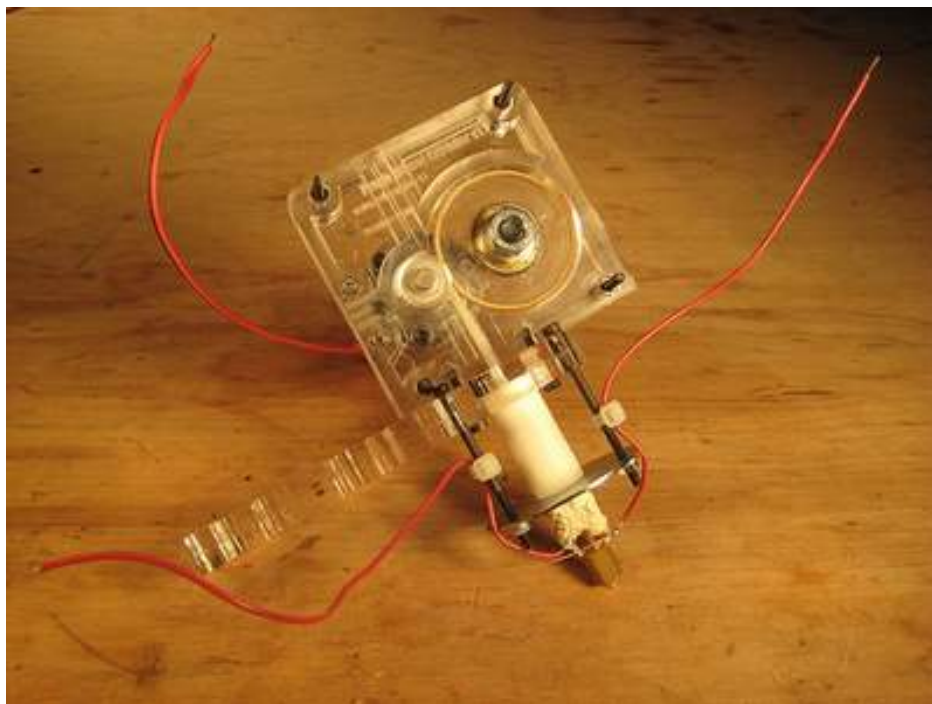

Update on the pinch wheel extruder v1.1 design:**It works!**It works really really well. I'm a happy little daddy.

I posted the initial design a few days ago, which was just the filament drive portion. Thanks to the wonderful RepRap community, I received a bunch of very excellent design suggestions! I've implemented as many as I can, and updated the design with a whole bunch of improvements. The result is an extruder that is much more powerful, easy to operate, and safer than the standard designs. Here are a few of the changes:

1. Complete Extruder Design

I borrowed the mounting design / heater assembly from my modification of Ian's lasercut extruder. This makes it easy to mount the extruder on a rewrap, and easy to mount the heater to it. It is now a fully functional, complete extruder design!



2. New Gear Source

Thanks to Corwin, I found pretty much the perfect drive component from sdp-si.com: It's 10.3mm OD, 6mm bore and it fits *perfectly* on the motor shaft. It even has flanges to guide the filament! Additionally, the teeth are much sharper and deeper than the pulleys that I got from McMaster. What a nice bonus! It is part #A 6A51M017DF0306 if you're interested.

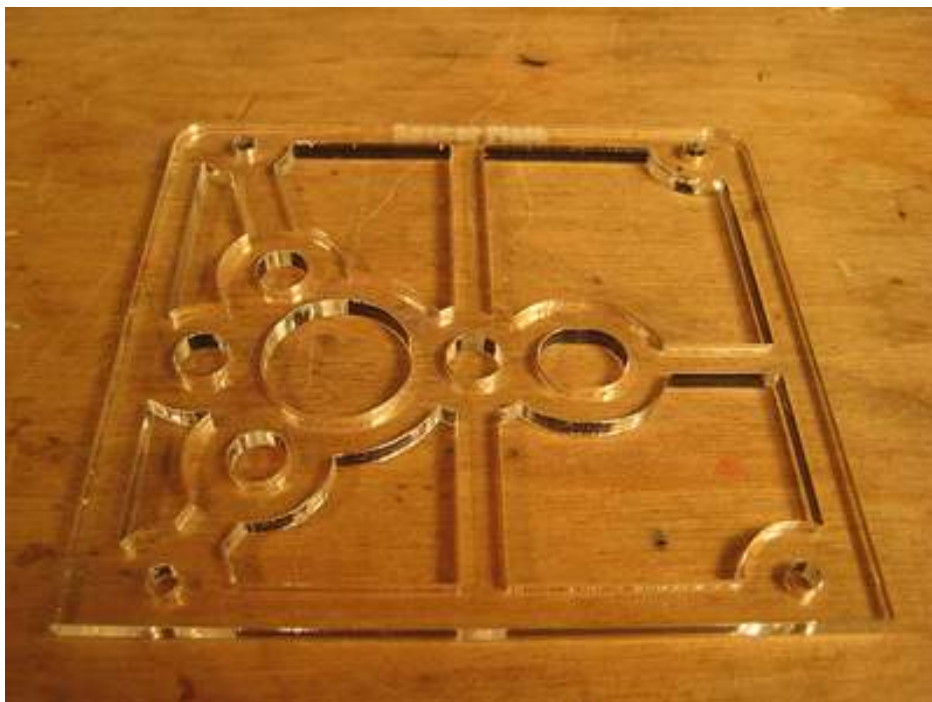

3. Lighter Design

I lightened the design and added cut-outs of non structural components, so the whole extruder clocks in at 1.25lbs, or ~560g. The bulk of this is the motor, which is about 260g, I think. I ordered a few lighter motors from 120g - 200g which should drop the weight down even more. Regardless, I hooked the extruder up to my RepRap machine and it had no problems moving that amount of weight around.

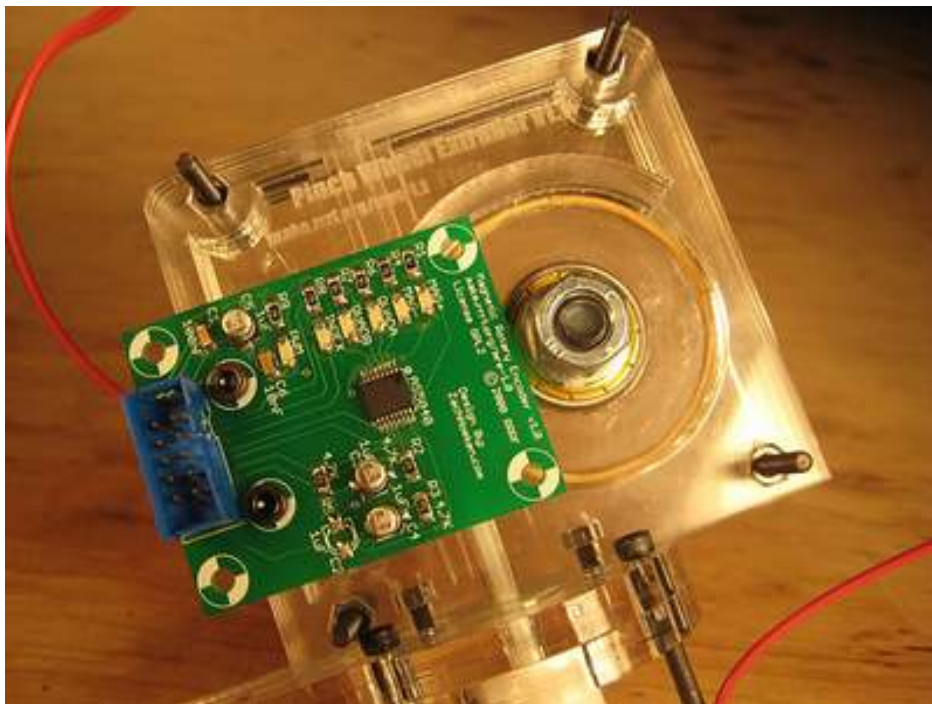

4. Easy electronics mounts!

As a super awesome added bonus, I modified the design to make mounting the electronics to it stupidly easy: First off, the magnetic rotary encoder board will mount directly to the board to give you super precision control over the motor speed. Secondly, I made the four corner bolts to be exactly the proper spacing for the new Extruder Controller v2.0 board which I'll have prototypes coming for in the next week. I don't want to leak too many details yet, but its going to kick some ass: onboard atmega168, so it'll 'be' an arduino, screw terminals for motors, pwm, etc, and RS485 for error free comms to the motherboard. It will mount directly to the extruder, and you can easily wire everything up to the board. Then the only wires you'll have trailing back to the motherboard are power and comms. Yay!



5. LED Mounting Holes

What design would be complete without the option to add some LEDs? Well, the design now has two holes that you can easily and simply press-fit some 5mm LEDs into for a nice backlit / edge lit clear acrylic action. Combined with the weight-reducing honeycombing, there will be some very gorgeous reflections going on. Beautiful and Powerful. Yay!

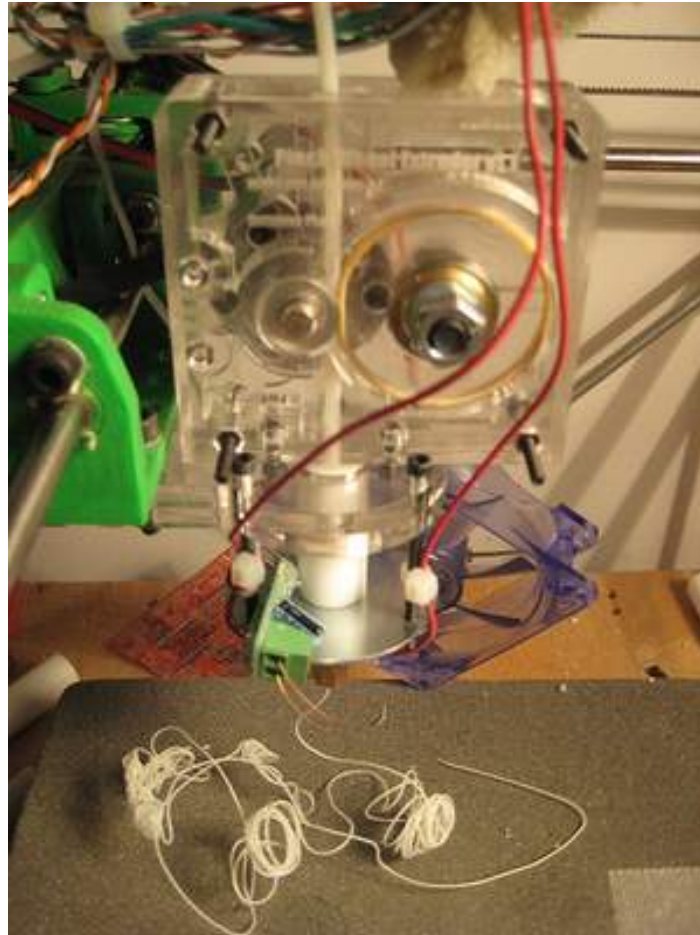

Did I mention it works?

Yeah, I fired it up last night and had a do-or-die moment where all my hard work the past 5 days was on the line. What happened, you ask? She performed flawlessly!!!! The motor had absolutely no problem keeping up with the extrusion. The gear didn't slip a bit, and the extrusion rate was rock solid, even without an encoder to provide feedback. The fact that the motor is geared down so much means that it has a very steady speed. This translates into very steady extrusion. I went through a meter of ABS like butter. I was too excited to take measurements, but the initial test showed that I can extrude at what looks like speeds from 8mm/sec up to 15-20mm/sec. I'll be measuring extrusion rates today. Will post more info later.

Anyway, now I need to really thoroughly test it, make some prints with it, and get it ready for production. You can get the designs on [Thingiverse](#), or in RepRap subversion. There are a TON of pictures in my [flickr set](#) as well. I'm going to Madrid for 3 weeks to run a RepRap workshop, but I'll try and get kits up as soon as I get back in mid-February. In the meantime, beg, borrow, or steal your way into a laser cutter if you want one.

After Darwin: Should Mendel be a specific 3D printer or a technology toolbox?

Friday, 16th January 2009 by Forrest Higgs

In which your narrator suspects that we are using the wrong model of evolution...

Darwin has been a roaring success by virtually any measure you'd care to name. In April of 2008 we had exactly five reprop and repstrap printers more or less operating. Last month, Dr. Bowyer estimated that several thousand were either operating or under construction. That's not exponential growth. It's hyperbolic. I, personally, have no doubt that in 5-10 years Dr. Bowyer is going to find himself on the Queen's annual Honor's List. Mind, in my opinion he richly deserves it. That said, I wanted to share a few ponderings that I've been nursing on the nature of change in the reprop movement for the past few months.

Basically, Reppap has two models of evolution going on in parallel. In the core team, we see what I will call a punctuated animal model of evolution while the larger reppap community is a very vibrant bacterial model.

Back at the end of 2006 and the beginning of 2007, the Reppap Core Team had several prototypes for a first release Reppap machine; Da Witch in New Zealand,

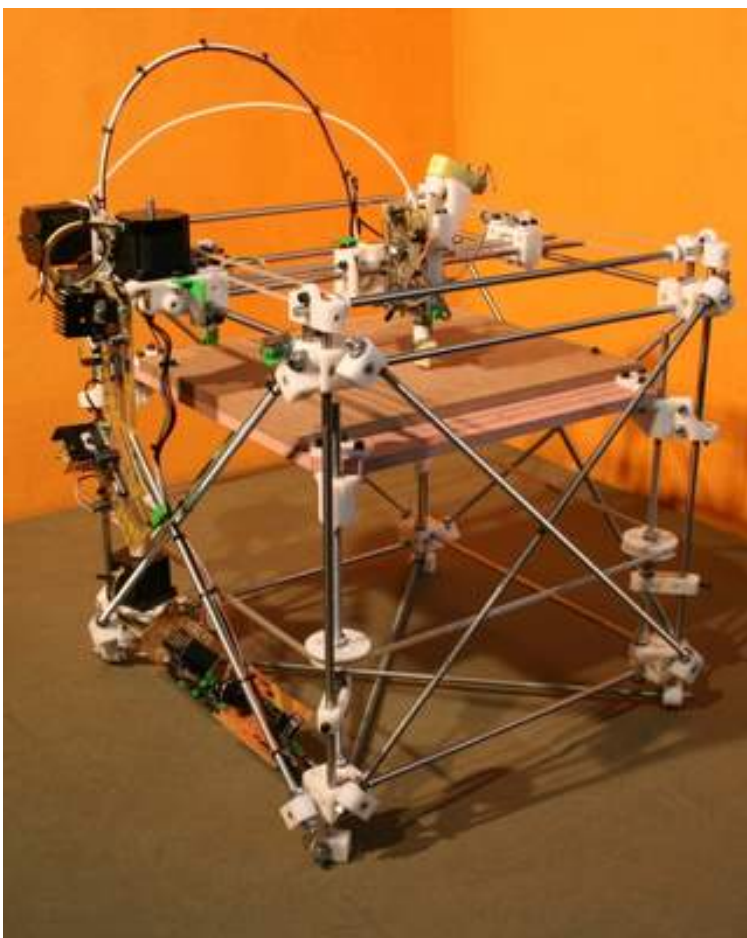

A.R.N.I.E. at Bath

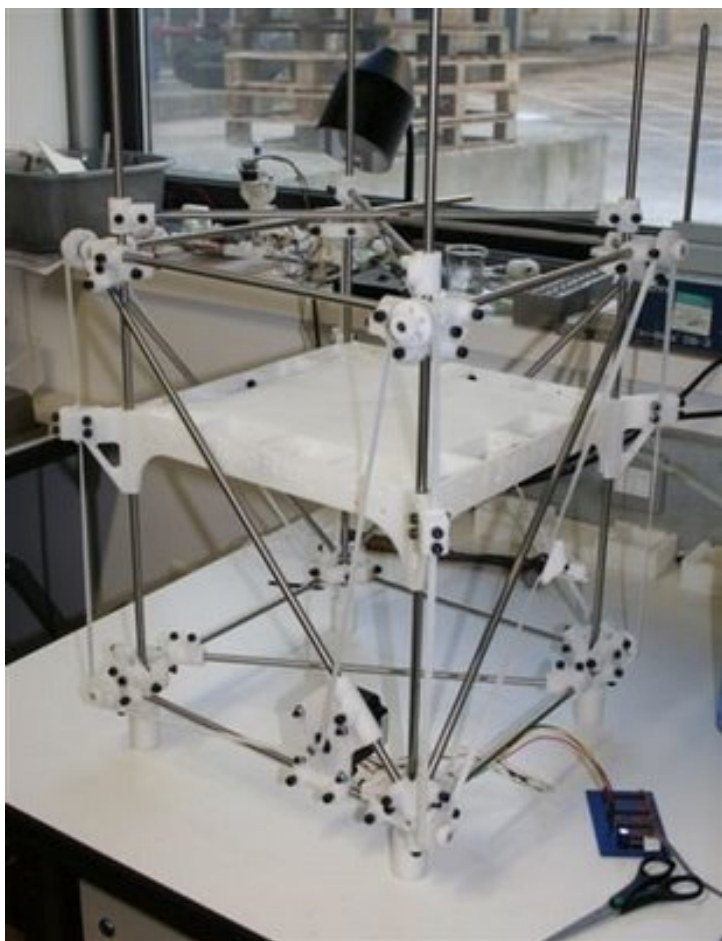

and Tommelise 1.0 in the US.

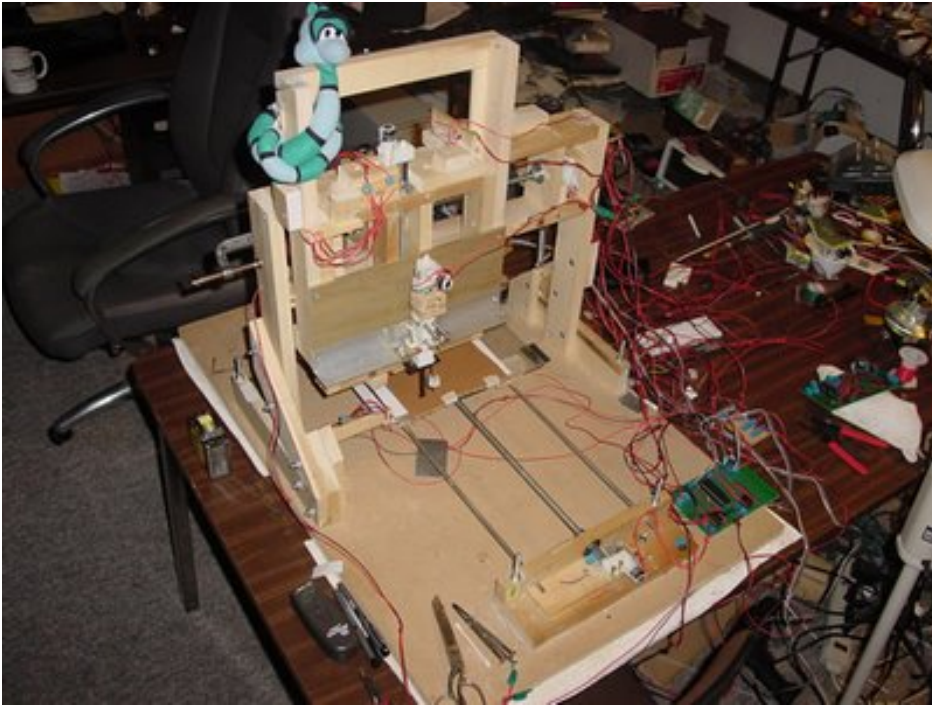

By March of 2007, Darwin, which was to become the first official release rebrap machine had grown out of the A.R.N.I.E. prototype...

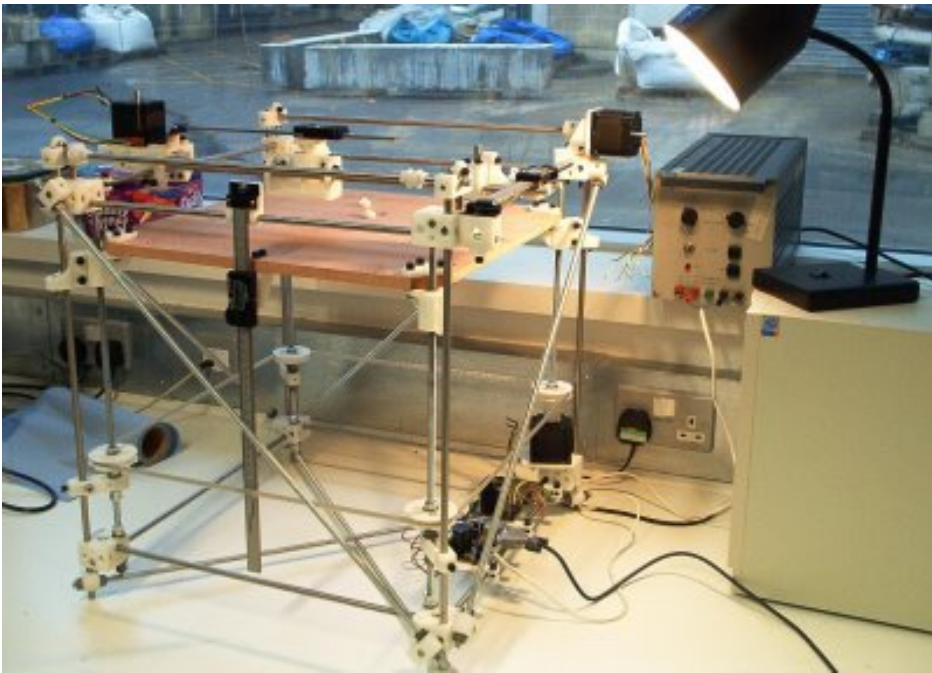

...and by the second quarter of 2008 Vik Olliver had managed to print a full parts set for a Darwin with his Darwin machine.

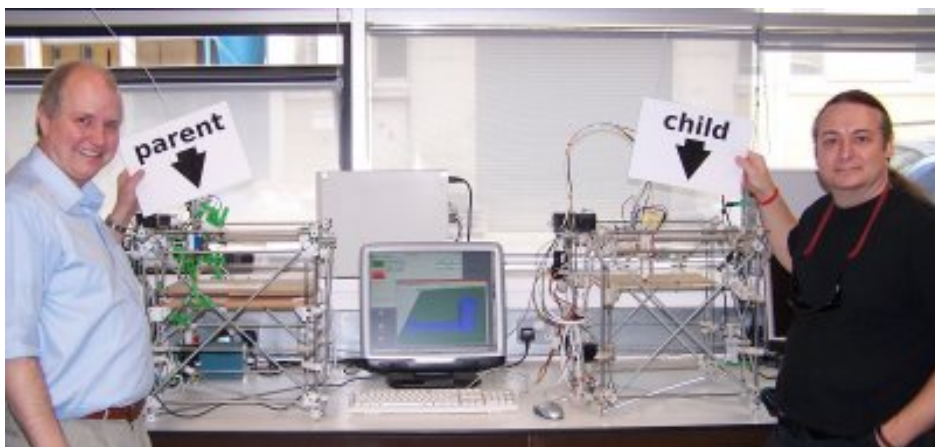

Then a very curious and totally unexpected thing happened. Fully 6 months went by before a Darwin replicated again, this time in Canada.



By that time, however, by Dr. Bowyer's estimate the population of Darwins were in the low thousands. What had happened?

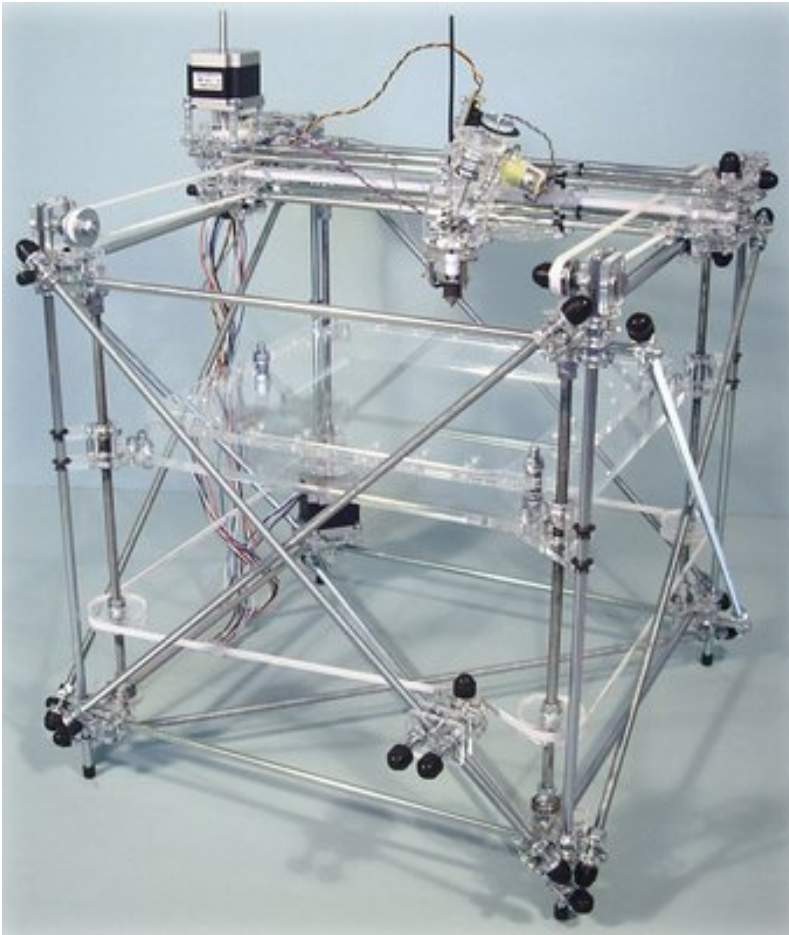

Basically, Darwin morphed into a fully industrial product. It began with the controller boards being outsourced for production by the Reprap foundation and has culminated with a shippable kit purchasable for US\$1,100 {shipping not included} requiring little more than the sort of assembly you'd be expected to apply to something bought from Ikea. What is getting built out there in its thousands, to use Dr. Bowyer's metaphor, is 100% vitamins - 0% replicated parts.

These aren't really Darwins, they're repstrap machines. You could use one to make a Darwin, but they aren't. Further, because they are repstraps, the machine you print with one isn't even the machine you're printing. The parts in it are laser cut, not printed. Now I suppose you could, if you wanted, print the laser cut parts. I haven't seen anybody attempt this, though.

A few tentative attempts have been made towards coming up with a second generation mainstream reprop machine. The most notable effort in this regard has been undertaken by eD at Bath university.

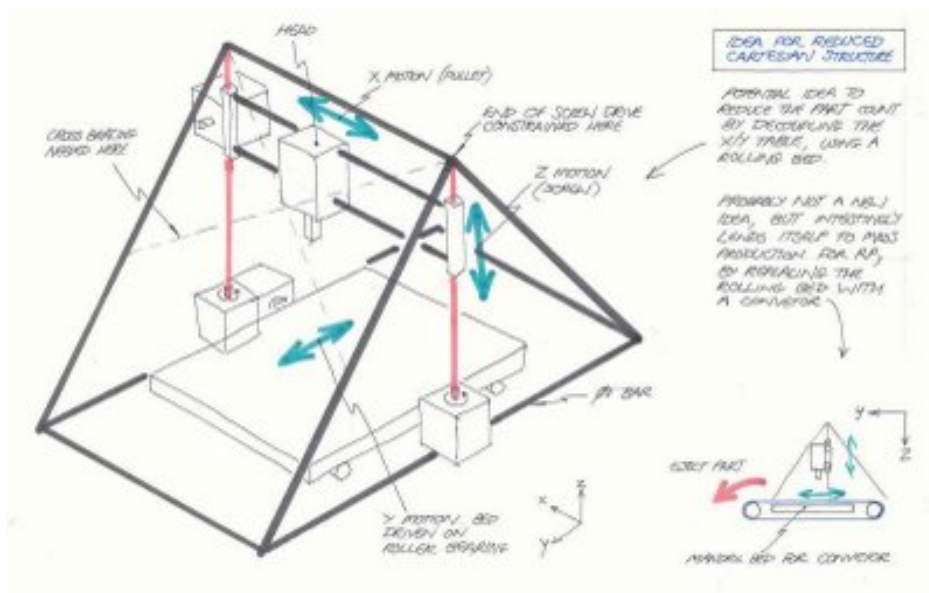

eD's new design promises to be considerably simpler to build and less materials-intensive than our current Darwin design.

We've found ourselves increasingly sliding towards designing with industrialisation in mind from the onset. Instead of designing simpler electronics that would be easy to cobble together, we have been designing boards with parts like surface-mount chips friendly to outsourcing and short production runs. Design, for absolutely the best of reasons, has been getting more and more centralised and unified.

I think that this has been happening in large measure because of the model of evolutionary development that the core Reprap team have been using. While we have been giving lip service to Darwin's original theory of natural selection, in practice we've been using Richard Goldschmidt's Saltation theory in which very large changes happen from one generation to the next.

I think, and this is my personal opinion, that we really haven't thought about the implications of what we are doing when we come up with a single specification for a particular generation of Reprap machines. Single specifications presume a particular environment of parts availability. As practice has shown us there ain't no such thing as a general availability of a particular set of parts for the Earth as a whole or even large parts of Earth.

The only place that sort of thing can economically happen is on a factory production line variously defined. That's why there are factory production lines and that's why it makes sense to make something at one point on the planet and then ship it everywhere.

If we look, however, at the larger Reprap community we see a very interesting thing happening. For example, lathes are relatively expensive and have a learning curve associated with them so in one place we see things like this

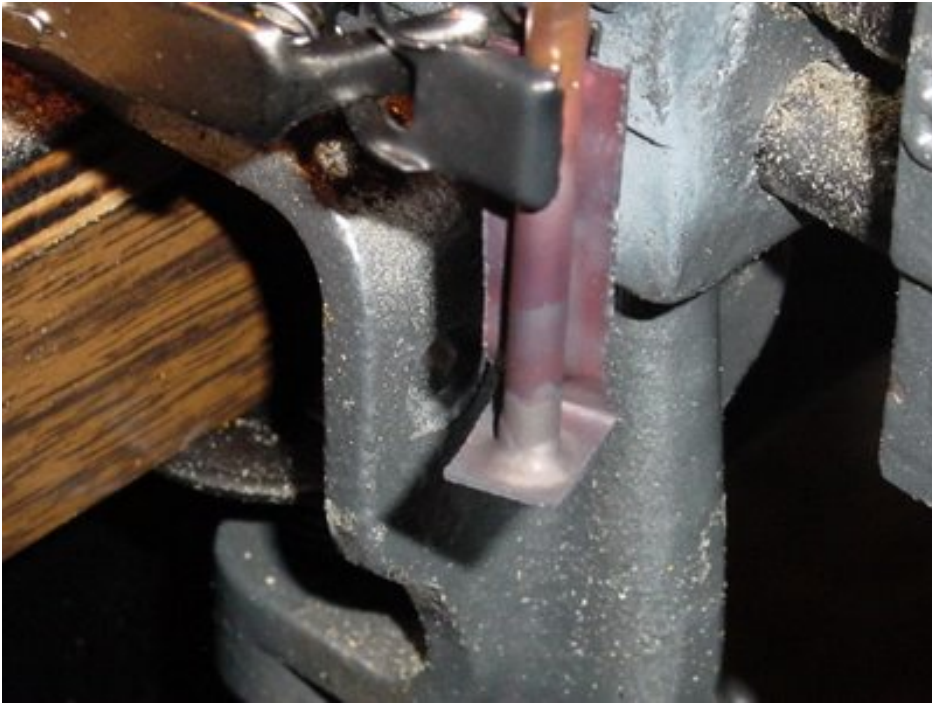

In another place nichrome wire and ceramic potting material is difficult to obtain so magical solutions like this occur...

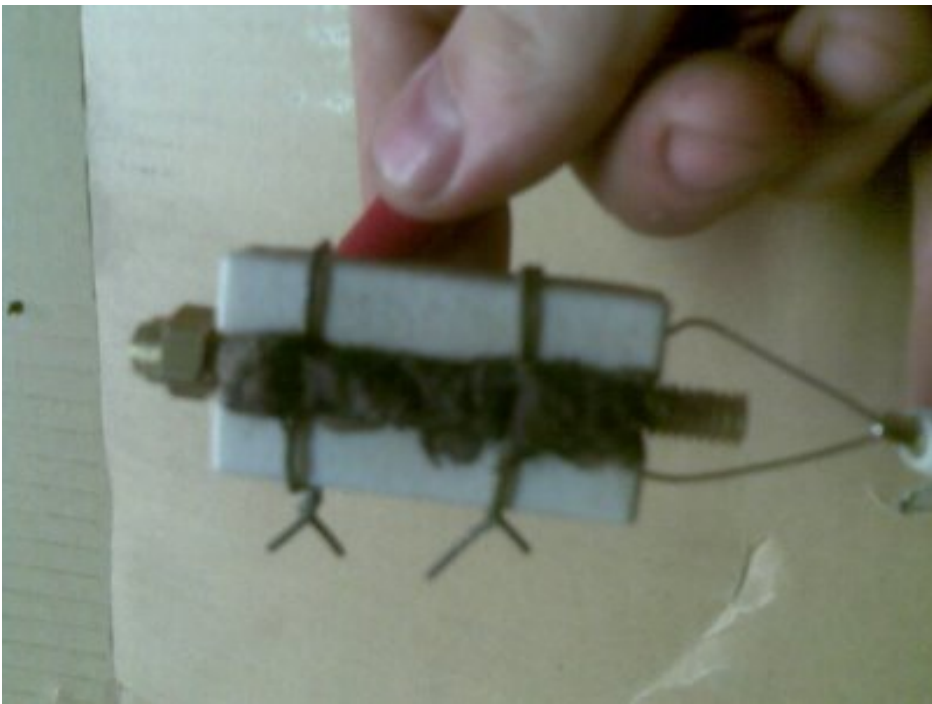

While the Reprap Core Team is practicing Saltation, the larger Reprap community is practicing Horizontal Gene Transfer, a method of exchanging recipes that enhance adaptability and communal robustness that bacterial populations employ to manage extremely rapid evolutionary rates and exploit new environments.

If you look at Darwin, for example, you can subdivide it into a set of different parts or systems, depending on how you look at it. A quick partial tree structure of Reprap Darwin looks a bit like this...

- 3D modeling software
- Slice and Dice software
- PC-side control software
 - communications
- Positioning system
 - mechanics
 - firmware
- Toolheads

I think, and this is again my own, very personal opinion, is that the core team needs not so much to dictate the technologies used as manage and facilitate the interstices/interfaces between the different parts and systems while letting the community at large provide the microenvironment-specific solutions to problems.

There are, for example, at least half a dozen solutions in the community to controlling a Reprap machine. Some depend on open source compilers, some don't. Similarly, there are a variety of kinematic solutions to the question of positioning the toolhead.

As a practical matter this means that the Core Team needs to climb down from more than a few articles of faith that it holds about what belongs in a Reprap machine and concentrate more on the much more difficult task of managing and interfacing the rich diversity of parts and pieces that have been developed by specific community members trying to solve specific problems in particular environments.

If we do that, as I see it, we have a chance of creating a prototyping/production capability that truly can diffuse into the furthest reaches of the planet. As it stands now, we're developing technology that is easy to make in a factory, put in a box and ship worldwide. In my opinion, what we have slipped into doing now is the antithesis of what we set out to do so many months ago.

Pinch Wheel Extruder Is Alive

Saturday, 17th January 2009 by Zach Smith

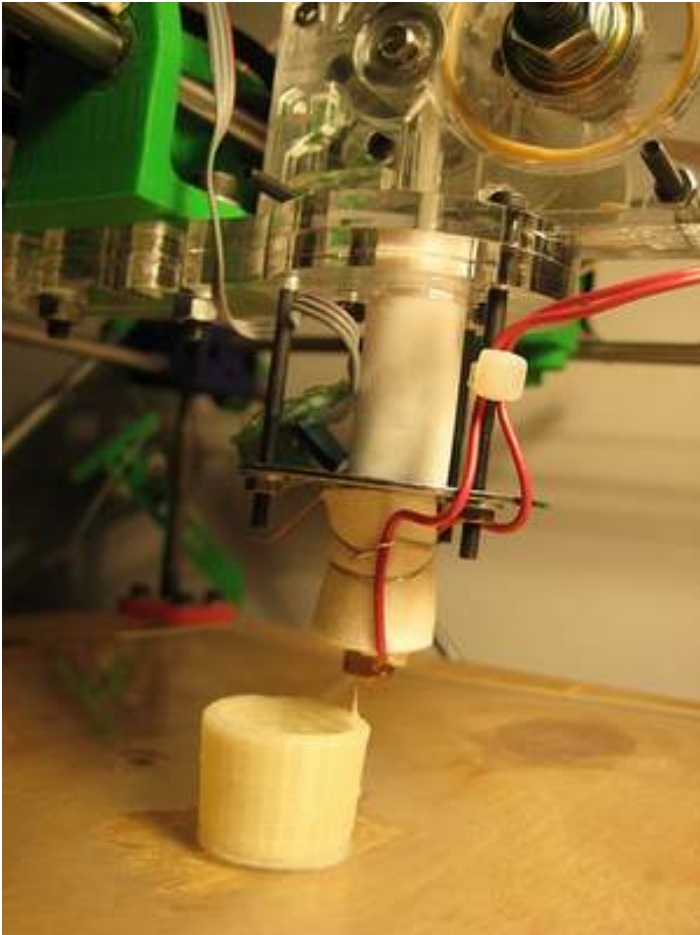

After I got the Pinch Wheel extruder working reliably, the obvious next step was to actually print something with it, right? I spent the past 2 days doing just that. I'm a big fan of Enrique's Skeinforge program, and I used that to generate the GCode for printing a minimug. It took me about 10 tries before I homed in on the proper settings, and they're still not quite right. Skeinforge is an excellent program, but there are a ton of settings that I just don't understand. Hopefully as I use it more, they will become clear to me. If anyone has some tips or tricks, please let me know.

Anyway, here was my process:

1. Use science* to get a feel for the extruder properties. I measured the ooze-rate after I turned the extruder off, and also the length of filament extruded at a certain speed for 60 seconds.
2. Put these measurements into a document to calculate extruder flowrate, etc.
3. Input these values into the Skeinforge program
4. Do a test print, tweak Skeinforge properties to improve build quality.
5. Rinse and repeat.

* for very loose definitions of science

Of course, it wasn't without its mishaps. Here is a short list of things that went wrong:

1. Don't extrude onto superglue on acrylic. The filament attaches really well. I mean really, really well. I destroyed my best print getting it off the acrylic :(

2. Don't use short lengths of filament. The new piece of filament tends to go to one side, while the other filament goes to the other side, jamming things up. Always extrude from a continuous length of filament, like from a spool. If you have to change filament, loosen the idler wheel, and pull out the old filament while its still molten so that the new stuff goes all the way to the melt zone unimpeded.

3. A good tightness is when you can see individual 'stretch' marks on the plastic from the gear teeth. This is also a good indicator of progress as they look like tick marks and the acrylic is clear. A bad tightness either produces small notches (too loose) or will creak and turn the whole filament the 'stretch mark' white (too tight).

4. The extruder *can* destroy itself. When feeding filament the first time, make sure you cut the end to a point with some wire cutters. this helps it self-feed. Watch to make sure it doesn't follow the idler wheel and that it does down its proper channel into the PTFE. If it doesn't, simply loosen the idler wheel, remove the filament, cut the 'chewed' part, and try again. I didn't destroy my extruder, but that's because I paid close attention.

5. If you haven't used your RepRap machine in a while, make sure you oil the bars and threaded rod that need to be smooth. This really makes a big difference in both noise and print quality. For example, I've been fighting with extruder designs for a couple months and have not done much printing. My machine was covered in dust and crap. Giving it a good once-over really did wonders.

6. If the extruder does jam, the teeth will carve out a little 'semi-circle' of plastic on the filament. To fix this, you simply loosen the idler wheel (notice a pattern?) and remove the filament. Cut it to a smooth place with wire cutters, re-tighten the wheel, and re-feed it into the extruder.

Anyway, today was a successful day! My extruder didn't give me any problems. It was rock solid, and very easy to use. The extrusion rate was very nice... very little variance at all. This is mostly due to the gearing and the high torque of the motor. I didn't even need to use a rotary encoder, although there is the option.

Also, the feedrate was very good! I'm using the smallest metal timing pulley that SDP-SI.com supplies, and I was getting about 16mm/sec feedrate @ 0.64mm diameter (960mm/minute). With a larger pulley, I could undoubtedly get a higher feedrate.

Yay!

CSG Evaluator - An Aol plugin for convenient Boolean Operations

Saturday, 17th January 2009 by Zach Smith

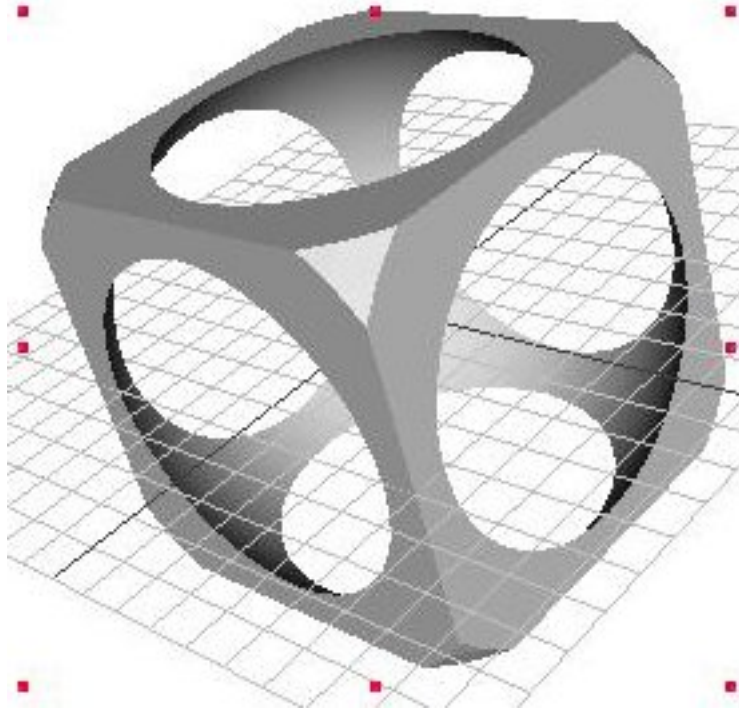

The guys over at [Metalab](#) have been kicking butt on RepRap related stuff for a while now. They just posted a new blog entry about a plugin for Art Of Illusion that makes it easy to do lots of boolean operations. This may just be the thing that AOI needs to make it easy for people to design printable designs easily.

Read more on [their blog entry](#).

4 Dimensional RepRap

Monday, 19th January 2009 by Adrian Bowyer

No - we're not doing an open-source time machine. When we get round to that we will do it last year.

This is a more prosaic idea prompted by G Codes and the fact that several people are doing stepper-motor-driven extruders or ones using Zach's neat shaft encoder. I hope I haven't stolen it from Nophead and recycled it as my own idea...

Clearly if you have a stepper extruder there is a precise relationship between the length in mm of filament extruded and the number of steps (this ignores time delays, melt compression and so on - run with me on this). So, why not incorporate the number of mm of filament to extrude as a dimension on each movement? You'd have things like

```
G1 W50.0 X30.0 Y40.0 F560.0
```

Where the W coordinate is the number of mm of filament to extrude. This could either get bigger and bigger as a build progresses (we're not going to run out of floating point numbers...) or we could have a convention that zeros it before each move, so it's Pythagoras on the X and Y numbers.

With that we can then control the machine with a 4D Bresenham DDA, which is just as easy to write as the current 3D one and takes hardly any more microcontroller space.

We can then obviously play tricks to get more or less extrudate:

```
G1 W100.0 X30.0 Y40.0 F560.0
```

would make a fat spongy line and

```
G1 W25.0 X30.0 Y40.0 F560.0
```

would make a jejune one. You can run the extruder without moving to take up any slack:

```
G1 W10.0 F560.0
```

and of course you can move with it turned off by omitting the W value altogether.

I'm not sure if this is:

1. Clever,
 2. Dumb,
 3. Obvious, or
 4. Useless.
- Thoughts?

HACDC RepRap Buildathon

Tuesday, 20th January 2009 by Zach Smith



Image not found.

This weekend, I'll be heading down to DC and leading the build portion of a RepRap workshop. If you're in the area, you should stop by! Its free!

Join the HacDC and and the Baltimore/Maryland RepRap User's Group (RUG) for a weekend of RepRap fun! Save the weekend of January 24/25 for our RepRap Build-a-Thon. Initial plans include a range of activities, including hands-on group construction a RepRap Darwin from the ground up starting with laser-cut acrylic parts. We are also planning on having several local RepRap builders on hand with their machines, and hopefully able to demonstrate them in operation, making stuff!

More info on the HacDC website.

Almost immediately afterwards, I'll be hopping on a plane for Madrid to run a 3 week, intensive RepRap workshop with Medialab Prado as part of their Interactivos Garage Science project. If you're in Madrid, you can apply to be a collaborator. Also, our very own Adrian Bowyer will be giving a talk on how awesome digital fabrication is.

Wahoo!

Going high risk steampunk

Tuesday, 20th January 2009 by Forrest Higgs

In which your narrator finally gets stuck into exploring other prime movers for future reprop machines...

Some time ago, Tigertaler, one of our more creative Reprap fanatics, did a series of design charrettes for printable stepper motors which he published on Youtube. His designs {example shown above} looked at using solenoids as a motive force for cleverly designed kinematics to achieve stepping motion in a highly heterodox manner.

His logic is impeccable. It is a lot easier to wind a solenoid coil than it is to do the windings and rotor construction for virtually any kind of electrically powered motor you'd care to name. I'd mooted this notion around the Reprap Core Group before. Nophead noted that the frequencies that such a solenoid might have to reach to provide a useful combination of step size and rotational speed could well be beyond what could be achieved. Given that Nophead has likely forgotten more than I'll ever know about electronics, this tended to dampen my enthusiasm at the time.

Last weekend, however, a concatenation of events caused me to revisit Tigertaler's work. The previous week I'd very successfully milled quite a handsome anti-backlash assembly for a tin-can stepper powered linear drive. I built the assembly around a 1/4-20 threaded rod with the intention of driving it with a Kysan 25BY2414 rated for 12v and 0.2 amps/winding. When I got the assembly together it became obvious that the Kysan was not going to have adequate torque to propel the thrust collar at meaningful speeds.

I had two choices at that point. I could redesign the assembly for #6-32 threaded rod or I could buy a beefier tin can stepper. Anaheim had beefier tin can steppers at beefier prices for one-off. Both options were going to take more time while going for a beefier stepper was going to increase the price of the assembly. None of that pleased me to any great extent so I make a third choice and decided not to decide for a few days.

The whole experience had brought one lesson home to me. When designing something that takes power it is not always that obvious, to me anyway, just how much power it will take to make it go around. For testing purposes it's always nice to have a lot more torque than you need just to test concepts.

That was when the notion of using pneumatics came back to me. Pneumatic actuators power output depends on the pressure of the air supply. I'd bought myself a compressor for Christmas with something like that in mind. To date it has been doing yeomanry duty keeping swarf out of my

milling jobs. It is, however, capable of providing up to 150 psi (~10 atm) of air pressure and can easily drive nail guns and pneumatic wrenches. Pneumatic actuators are very small for their power output. As well, I should be able to mill them out of HDPE without a great deal of drama.

At that point I began to give Tigertaler's most ambitious printable stepper a very close look.

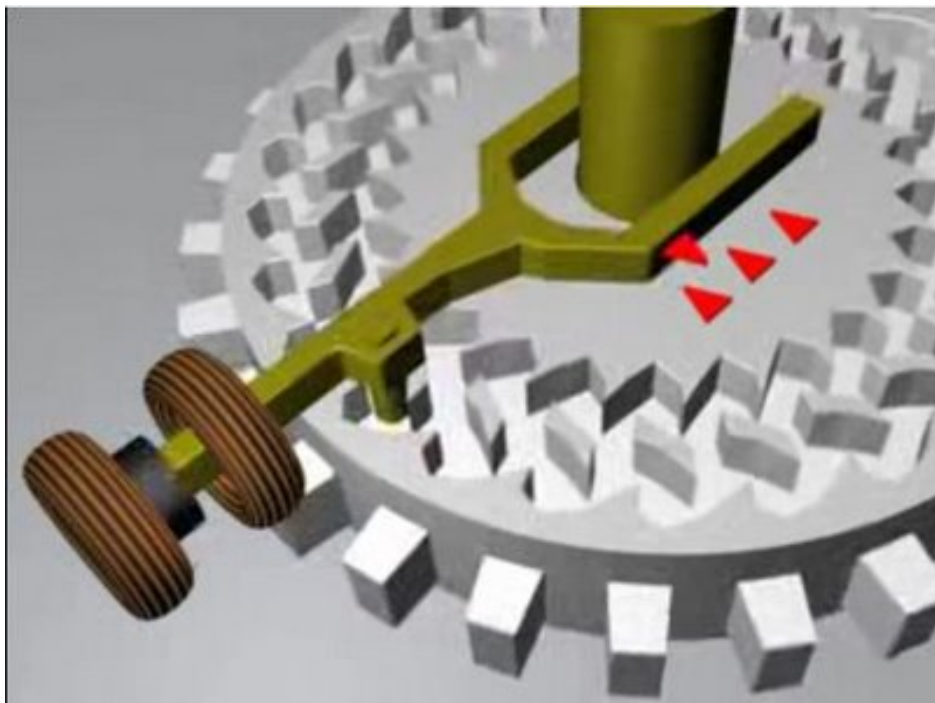

While it looked quite complex at first glance, in fact it was merely a repetitive presentation of a relatively simple mechanism. At that point I set about to develop a script that could do a slice description for milling.

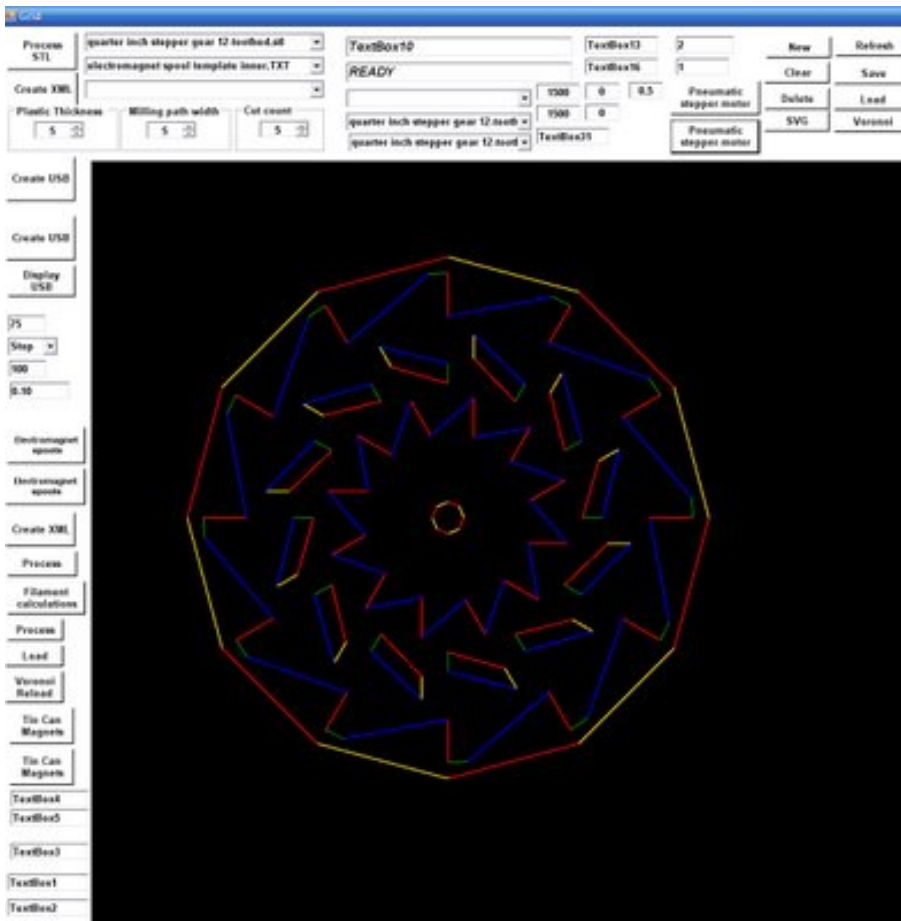

Now it remains to do a few modifications to my slice and dice app to accept a slice directly instead of insisting on generating it out of an STL file. I hope to be milling my first Tigertalar Steam Punk stepper motor in the next day or so.

3D printing on Facebook

Thursday, 22nd January 2009 by Adrian Bowyer

Reprappers may care to know that there is a new Facebook page for the 3D printing community called SME Rapid Group. If you're on Facebook, why not join?

There's also the Rapid Prototyping Electronic Mailing List at <http://rapid.lpt.fi/rp-ml/> that you can join too. That's been around for a while.

[No Title]

Tuesday, 27th January 2009 by Marius Kintel

CSG Evaluator plugin V1.1

Just a quick note to say that the CSG Evaluator plugin to Art of Illusion can now be installed using the Script and Plugins Manager from within Art of Illusion.

It's also tested to work with the recently released version 2.7 of Aol.

Conserving MCU pins via the I2C bus

Tuesday, 27th January 2009 by Forrest Higgs

In which your narrator finally gets around to demonstrating something he's been talking about for the better part of a year...

About a year ago I found myself beginning to work with the I2C bus when I decided that I needed a decent print buffer on the Tommelise 2.0 rerap machine. I ran across a 512Kbit EEPROM chip at quite reasonable prices that connected to the I2C bus rather than requiring a committed port on my 18F4550 MCU. For me that was wonderful in that I was committed to a single board controller solution rather than the multiple board scheme that the mainstream Darwin used.

I was astonished at how easy it was to integrate I2C EEPROMS with my existing board. They've worked brilliantly as a print buffer ever since then.

At that point I began to look around at other I2C enabled chips and discovered a wide variety of things that I could do with my MCU via the I2C bus. There were some things, however, that were simply not available in I2C format. After much grumbling, I finally had a "DUH!" moment. It seemed reasonable that Philips Electronics N.V, who had developed the I2C standard would have HAD to have created a generic I2C slave chip that could be interfaced to ordinary port-enabled IC's. If they hadn't, the I2C bus would have never got off the ground.

Sure enough, a short catalog search revealed that Philips had indeed created several such chips and that several other suppliers had developed their own I2C slave chips as well. I then ordered a dozen of their excellent PCF8574I2C slave chips, manufactured by Texas Instruments for a few dollars apiece. The PCF8574 gives you access to a single 8-bit port through the I2C bus while its bigger brother, the PCF8575, gives you access to two, 8-bit ports. You can hang eight of either chip type off of a single I2C bus. Mind, most firmware IDE's offer you software emulation of I2C comms which will let you assign more than one I2C bus.

The demands of my day job and other, more pressing issues with Tommelise 2.0, like making it mill plastics and printed circuit boards kept me from actually using the generic I2C slave chips on anything for many months. Last week, however, I got Tommelise 2.0 milling things properly and was able to take a deep breath and look at my "to do" list.

One big item on my "to do" list was to build an infrared ranging system, very short range radar if you will, for a telepresence robot that I eventually want to get running. Since the ranging system is a spot detector, I have to have an alti-azimuth positioning system which, of course, requires running a pair of stepper motors. I had been putting off designing new boards until I'd got the

printed circuit board milling system working. Last weekend, however, I saw the pile of Euro board format strip boards and decided that I might as well use one of them and see, as well, if I could prove out the notion that the PCF8574 I2C slave chip could be used to run the 754410 high-current half-H driver that I would be needing to drive the steppers.

I'm a very conservative board designer. I used the 18F4550 MCU that I have loads of hands-on experience and firmware from the Tommelise 2.0 project. I also have PC-side USB support software for that chip as well. It took me a couple of hours to design and wire up the board and about the same amount of time to chase down and fix the wiring errors that I made on it.

This morning, I took a few hours off and copy/pasted up the firmware to drive one of my little Kysan 25BY2414tin can steppers that I keep for testing. Oddly, I was not able to get it running with wave (single phase) stepping. That is puzzling in that wave stepping tends to work on anything. When I switched over to full (two phase) stepping, however, it ran without so much as a qualm.

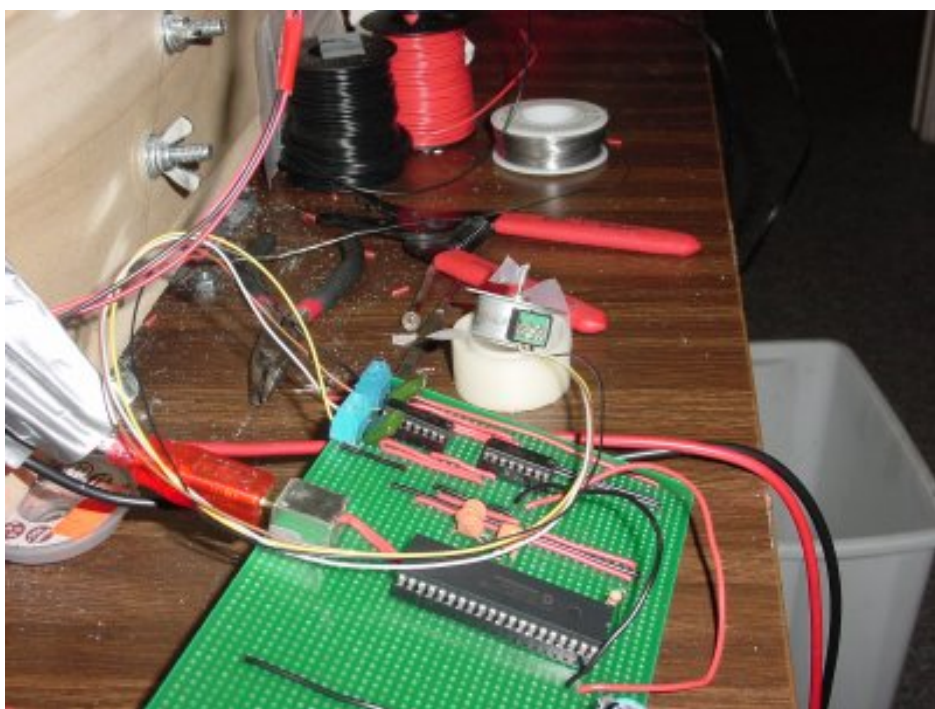

What was even more interesting was that I was able to push the Kysan up to 2,000 pps, six times faster than I had heretofore been able to achieve with wave stepping.

At that point, I decided to see if I could use one of my Lin Engineering 1.8 degree step Nema 17's that I'd bought in bulk when I first started working on the Reprap project. I wouldn't be using this stepper ultimately on my IR radar system because it was too heavy and drew far too much power (2.5 amps/phase) for what I needed. To choke it down to something my 754410 chips could handle (less than 1.1 amp/phase) I put 15 ohm power resistors in series with each phase.

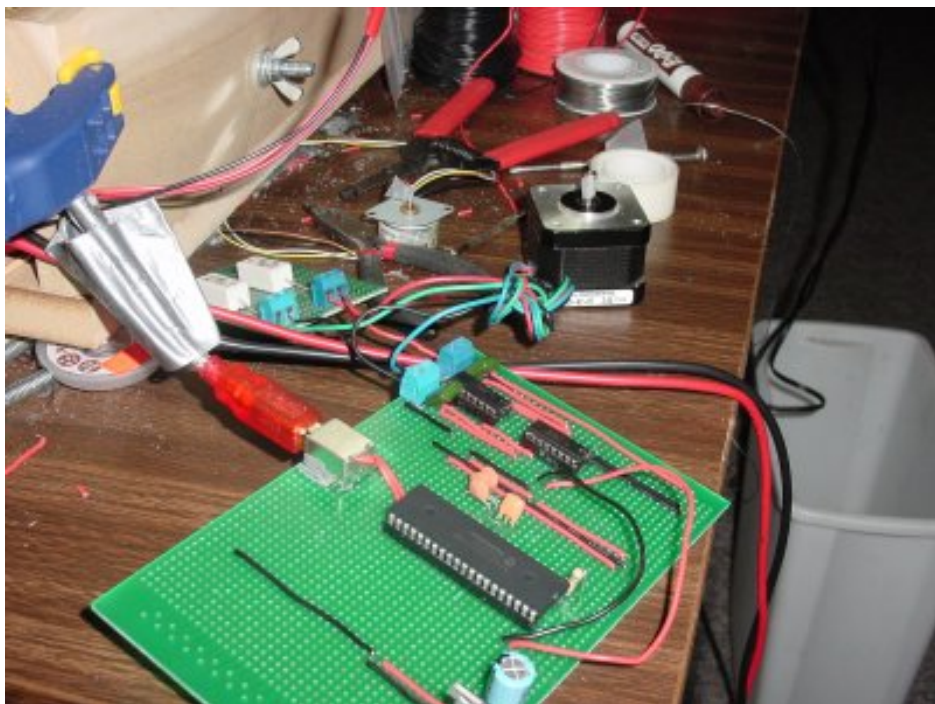

I was able to push the Nema 17 up to 2,000 pps as well before it started stuttering.

There had been some talk that I2C and steppers wouldn't be happy together. That appears not to be the case. The data sheet on the PCF8574 says that a read/write takes 4 microseconds. That's not long enough to matter even if we're running three or four steppers in concert.

What using I2C slave chips like I have lets you do is avoid having to go over to surface mount chips which let you have many more pins on your MCU which are directly accessible. Through the hole DIP chips are usually limited to a maximum of 40 pins with the rare 48 pin offering making an appearance from time to time. What happens with DIP chips is that the chipmaker makes one pin do duty for sometimes as many as six of the pins that would have been available on a surface mounted package for the same chip.

I've tried to use some of these stacked up function assignments on 40 pin chips. It seems at times that you have to do a dance around a fire on a full moon and sacrifice a goat to get at some of the functionality of stacked DIP MCUs at times. What I suspect is happening is that IDE vendors get tangled in their own compiler coding trying to make one set of code fit dozens of slightly different models in the same MCU family. It's certainly a pain for an unwary board designer.

In any case, hanging output and not-interrupt input functions that would ordinarily occupy IO ports on the I2C bus leaves you with very clean board landscape around your MCU. That's a big plus for me in that I'd like to keep my controller board design to a milled single-sided or simple double-sided board and avoid having to send my designs out to a board etching firm and pay set-up and minimum run charges.

It's been pointed out on any number of occasions that learning how to surface mount chips is no big deal. I have no doubt that that is true. What I do know is this. When you insist that audience know how to use Linux or at least how to do Linux-like builds on a Windows machine in order to get a mainstream Reprap machine running at all and when you insist that in addition to that that they learn C, not exactly the most user-friendly compiler out there to make changes to your firmware, adding to that learning how to do surface mount soldering seems to me to unnecessarily create a positively Himalayan set of barriers to people building and modifying mainstream machines.

That is not at all to say that there are not a lot of people out there who either already possess either some or all of those skills who are also interested in 3D prototyping. There palpably are or Reprap Darwin wouldn't be the amazing success story that it is.

I just keep coming back to my archtypical bright twelve-year-old. While there are a lot of them out there, the number that have knowledgeable father figures who can help them over the bumpy bits on the path to success is limited and getting smaller by the year as our society ... um ... "progresses". That's why I stick to Windows, which the twelve-year-old probably already has on his or her PC, Basic, which is trivial to learn for all its limitations and DIP chips.

Going for surface mount chips, for all their advantages and for all that the chip industry sees them as the future, for me is just adding another layer of difficulty to an enterprise which is already more than difficult enough.

Support for overhangs

Wednesday, 28th January 2009 by Adrian Bowyer

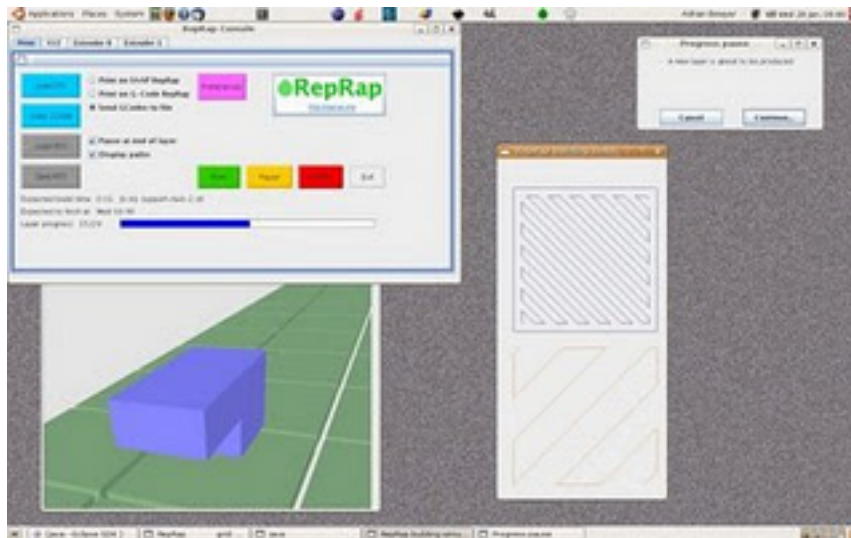

The latest Java host program in the repository now contains code to compute the support needed for overhangs automatically. Above is a screenshot of it working - the L block bottom left is being deliberately built the wrong way up so that it needs support. The layer currently being computed is shown in the diagnostic window. You can see the cross-section of the object itself (blue) and the support for the overhang (brown).



Here it is part-way through the build. You can see the support pattern at the front, and the pillar of the L-shaped object being built at the back.



Here is the build finished. The supported bit is at the front.

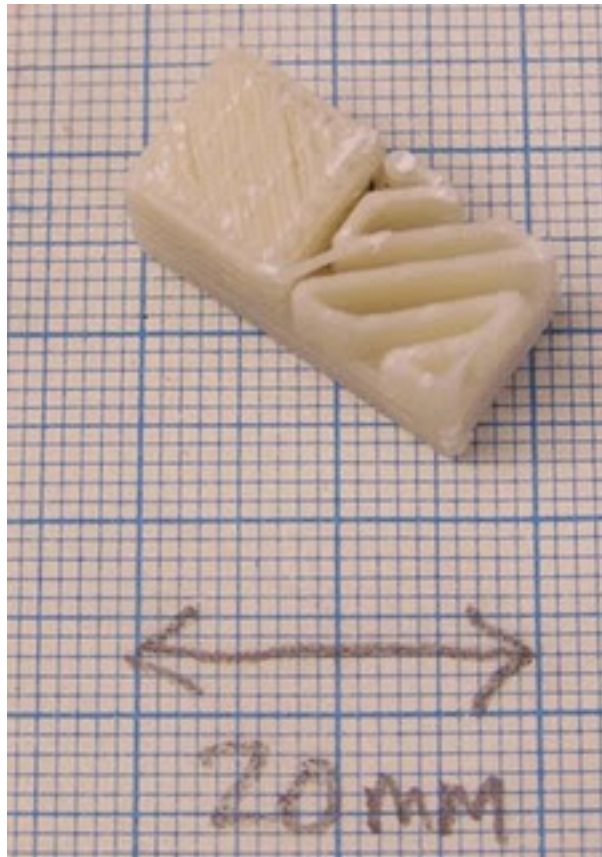

Here is the part after taking it off the machine viewed from underneath with the support still in place.

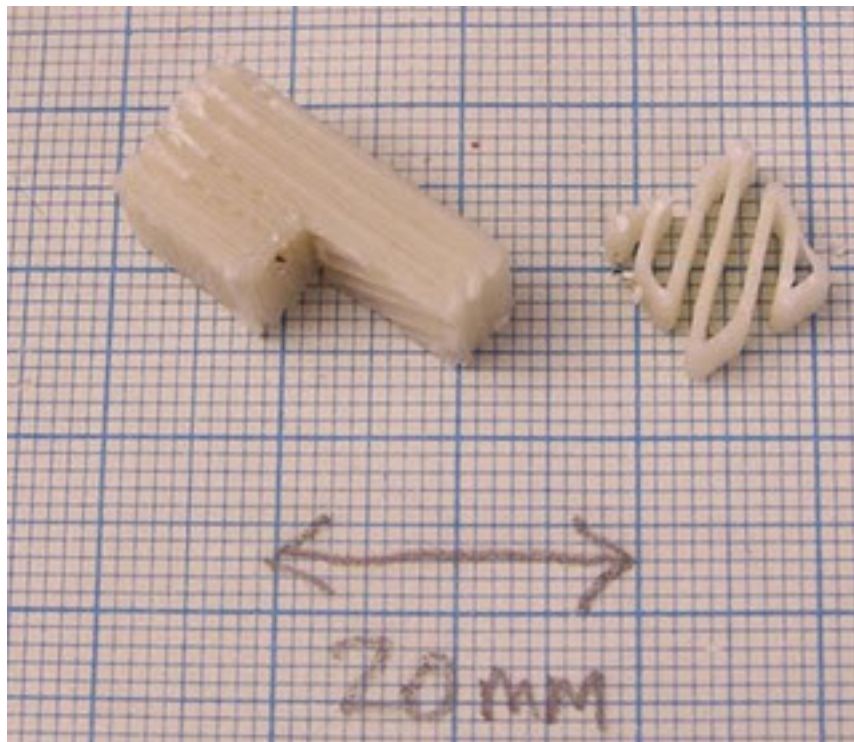

And here it is in its final form with the support separated.

The program allows you to specify a support material for each material in the RepRap machine by name. As the RepRap code allows you to have several logical extruders all talking to the same physical extruder you can use a material to support itself by copying its entries in the preferences file (sort the file first to bunch them together) then renaming them from Extruder_0 to Extruder_1 (or whatever). You then change the infill pattern of the support to whatever you want. Here I set it not to outline, only to infill, and not to change the direction of the ply between layers.

The support cleaved pretty easily from the part with a penknife blade, but I suspect that this would have been harder had the underside of the part been undulating rather than flat. Of course two extruders would allow - for example - a friable paste to be used as a support (my current favourite: cornflour mixed with a gel of PVA glue and methanol - to be blogged when I have some results...).

The supports are only computed by the host software when it is saving G-Codes to a file. The reason for this is that the software has to do the calculation in reverse - from the top down - so that it can know what's immediately above the layer it is currently creating. It can only do that by writing each layer as a temporary file, then concatenating them all in reverse order to actually build from the ground up when it has finished.

If you are interested in how the use of a CSG representation makes the support calculation easy to code, take a look at the

```
privatevoidsupportCalculations()
```

function in the class LayerProducer.

As you can see, I have not exactly tested the code on the world's most complex shape, so all this should probably be regarded as experimental...

I'm off for a week to give RepRap talks in Wales and then Spain. When I get back I'll try it on something a bit more challenging, and when it's working properly we'll do a release.

SolidEdge Version Poll

Wednesday, 28th January 2009 by eD

Hi! You may already be aware we're allowed to use Solid Edge under an academic licence for development. The current version of model file releases is under v19. However, I'd like to move to v21 as I'm getting stability issues with v19, however, I don't want to do that if it's going to alienate any SolidEdge modellers out there (you won't be able to open v21 files from v19).

So now's your chance to put it on hold (-> comments please). I'll give it a month - if I don't hear anything I'll move to v21.

RepRap in Madrid

Tuesday, 3rd February 2009 by Adrian Bowyer



RepRap (or a subset thereof: Zach and Adrian) has come to the Medialab-Prado in Madrid. Zach is running a build-a-RepRap workshop over the space of a couple of weeks, and Adrian is getting in the way, and giving a talk this evening.

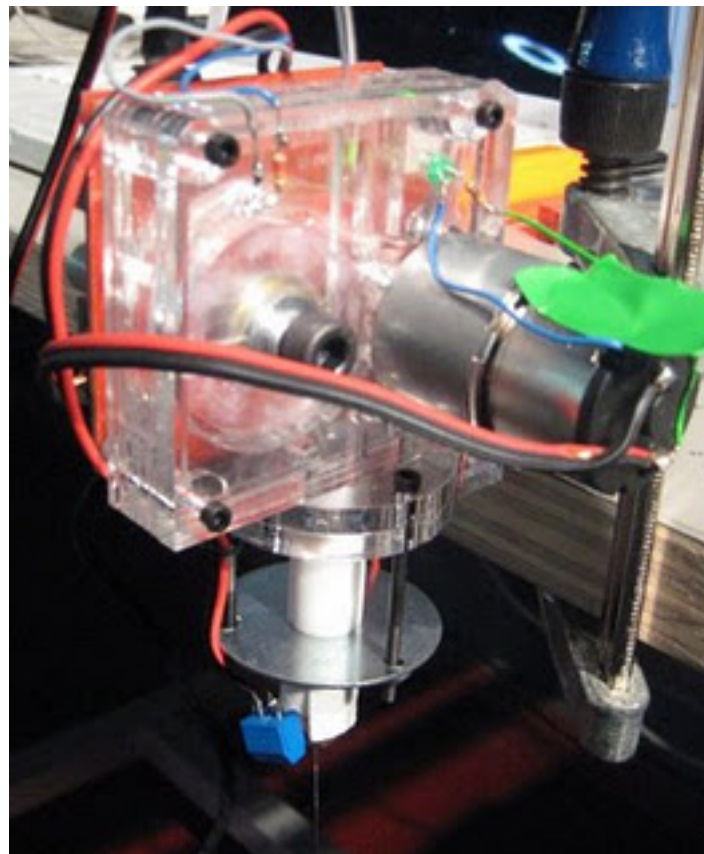

One experiment we did was enabled by Adrian's bringing 3mm PLA with him (the in-flight baggage checkers didn't like it, but let it on...). So here is Zach's pinch-wheel extruder running PLA for the first time. This was important to try, as we knew it worked with ABS, but PLA is much harder (that is, more difficult to pinch). It runs just fine, though interestingly the mix that occurred with the molten ABS already in there when we were purging it seemed very stiff.

And finally, nothing to do with RepRap, but some extreme gardeners extreme gardening just down the street...



First thrust plate for a printable stepper motor milled

Tuesday, 10th February 2009 by Forrest Higgs

In which your narrator turns plans into product...



I'd like to say that milling things has gotten to be routine. It isn't quite yet, though it's a lot more routine than it was six months ago.

I was milling the thrust plate for my pneumatic stepper motor and had got about 75% of the way through when I decided that I needed to take a few video clips and snapshots of the thing taking shape. Things went well until while taking a last set of shots the strap on the camera got snagged on the corner of the xy milling table without me noticing. When I stood up for a final shot the strap pulled the milling table off it's tracks and the end mill started chewing through the thrust plate at an alarming rate.

I'm taking that damned strap off of the camera!

I set up another milling job during lunch and a few hours later it had finished out pretty much without incident.

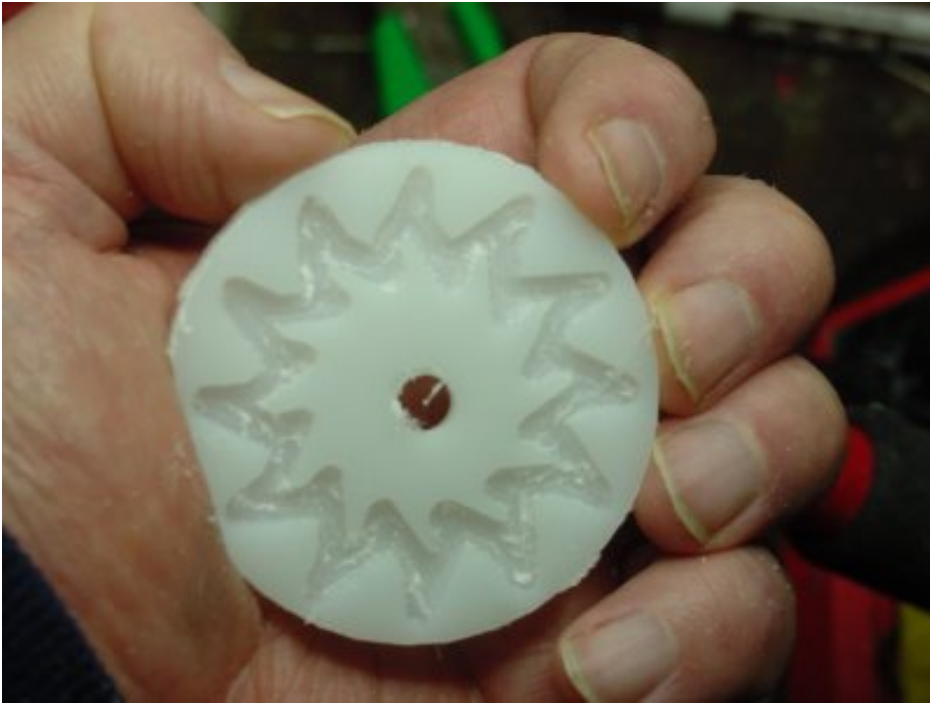

I'd worried that milling was going to be so hands-on that I'd only be able to do it nights and weekends. Aside from getting up every ten minutes or so and blowing the swarf out of the cut, that is increasingly turning out not to be the case. Mind, if I am to do useful work, I have to put on a set of ear protectors that in earlier days were used at the pistol range or my PC headset and tune in some music, but other than that there is little distraction.

I gave the thrust plate a quick test with a crudely-made thrust piston consisting of a scrap of HDPE and a #4 bolt. When Vimeo finishes uploading a short video clip of that little adventure in a few hours, I'll include it in this blog entry.

[A quick test of the printable stepper thrust plate from Forrest Higgs on Vimeo.](#)

It misses a few steps. That was a result of my equipment, however, not the design per se. I may want to redesign this thing for a shorter thrust distance.

The next task will be to design and mill a proper piston and thrust shaft and get this whole prototype working on compressed air.

RP Pinch-wheel Extruder

Sunday, 15th February 2009 by Adrian Bowyer

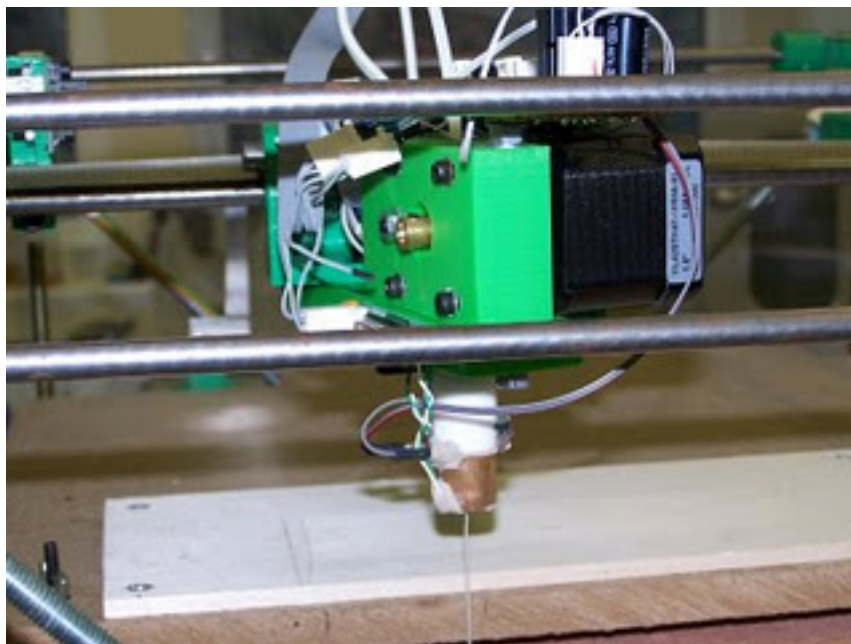

Inspired by [Zach's lasercut pinch-wheel extruder](#) and a comment from Ian ("I bet you could drive that direct with a stepper motor.") I decided to do just that and to create an RP design that RepRap could make.

Unfortunately, my RepRap was in bits having a couple of new toothed-belt cogs fitted, so I had to make this one in the Strat.

So. Here is a prototype. It works...

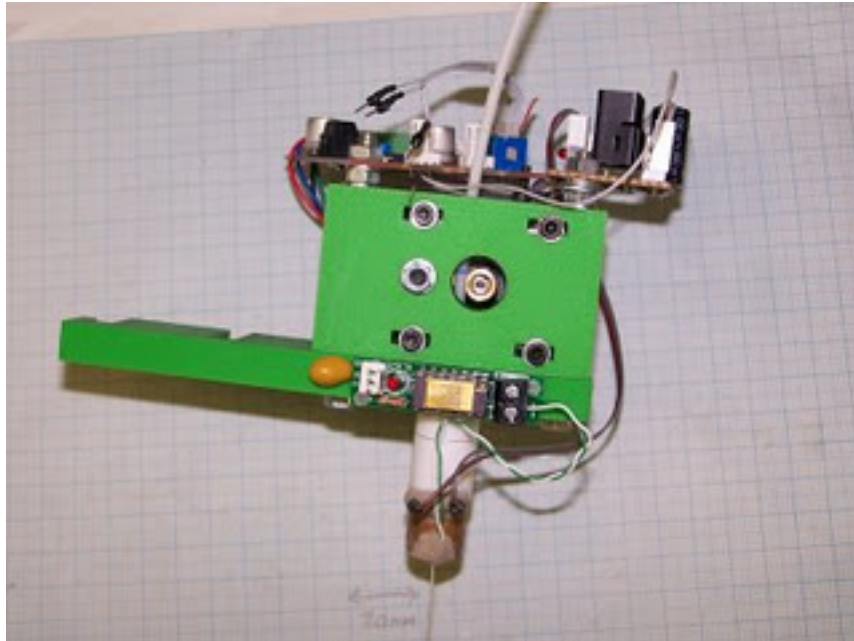

What's more, it only has two RP parts: the clamp that holds the heated barrel and attaches the device to the RepRap machine, and the pinch device itself. Here the whole thing is being driven by Zach's new stepper driver.

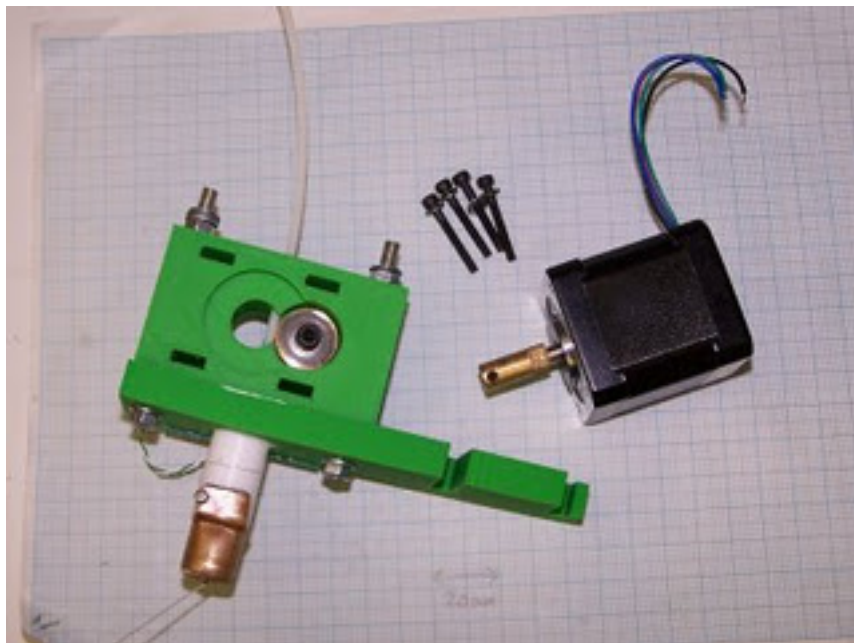

Here it is in bits. As you can see I put a brass collar on the stepper shaft. The collar has a knurled section to drive the plastic filament. (**Improvement:** I suspect it'll be possible to knurl the stepper motor's shaft itself and to get rid of that brass bit.) The filament is squashed against a ball race. (**Improvement:** use a smaller ball race and cut the size down.) Neither the ball race nor the collar need any sort of groove to guide the plastic - that is achieved by the hole down the block through which it runs.

I adjust the gap by sliding the whole motor in slots, rather than the more obvious method of having

a slot for the ball race. This allows the latter to be very firmly mounted, and means that there are four sliding screws achieving the adjustment, which again makes things very sturdy when it's all tightened up. To get the gap, I just put a 2.5mm drill down it, push the motor against that, and tighten the screws. That compresses the 3mm filament into the knurl-ridges by 0.5 mm, which seems fine for ABS.

I'm driving it by a modified version of the GCode firmware running on a Sanguino. I need to get the hang of the timer interrupts as I don't yet have the resolution to make fine speed adjustments. That is one point: the stepper is running very slowly - about 4 steps per second. The elasticity in the system seems to smooth out the flow, though - you can see a very slight jerkiness as it comes out of the nozzle, but I don't think that will cause too much trouble.

Finally, I tried a new way of mounting the PTFE in the clamp:

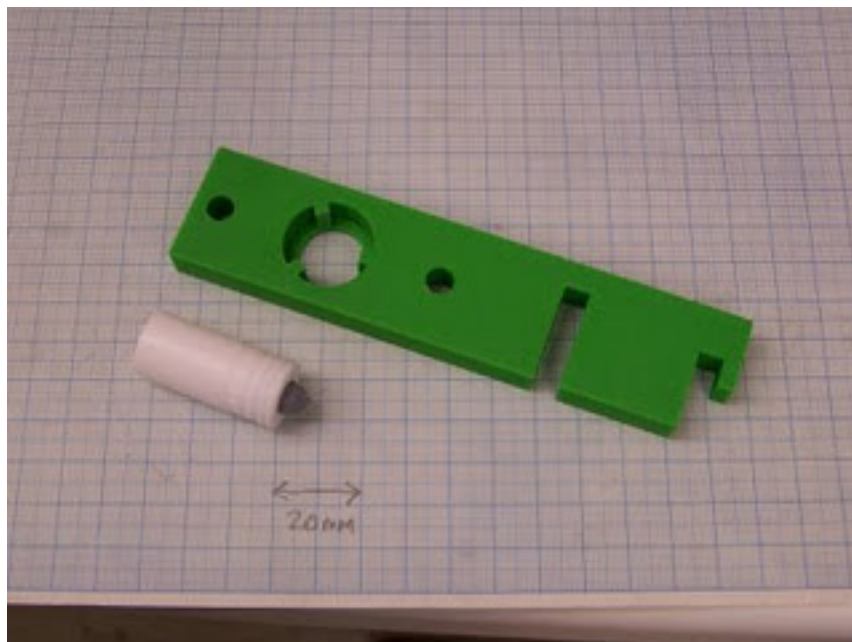

I put the PTFE in a Black and Decker and used a triangle file to run grooves in the top of it. (The little blob of Blu Tack is to prevent contamination.) I made a hole with three support webs in into which it just fits.

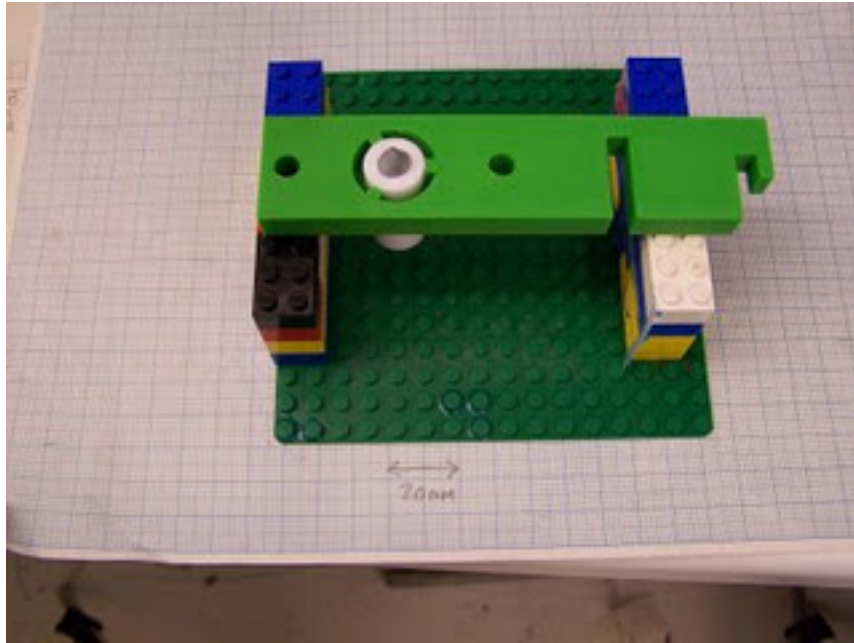

Then I set it up like this, put more Blu Tack round underneath to seal it, and poured PU resin into the gap alongside the support webs. It set, and made a very solid join. I suspect that any thermoset like Araldite or JB Weld would work just as well as PU.

This was the prototype (for example it uses a very non-standard ball race that I just happened to have in a drawer). I'll do a proper design and stick it in the repository ASAP.

Sanguino Software v1.4 Release

Tuesday, 17th February 2009 by Zach Smith

Marius Kintel has been doing some excellent hacking and updating of the Sanguino code. This guy is a rockstar, and I just have to give him props for his help. Sometimes I have a bad tendency of starting projects and not tending to them as I should (sorry!!!!) This release is pretty much 100% him, oh wait... it is all him. He fixed some bugs with the serial stuff, and just generally made it awesome.

Hip hip hooray!

You can download the new software from [Google Code](#).

EDIT: test *before* releasing... ;) removed stale files. all 2 of you, please re-download.

Back From Madrid

Tuesday, 17th February 2009 by Zach Smith

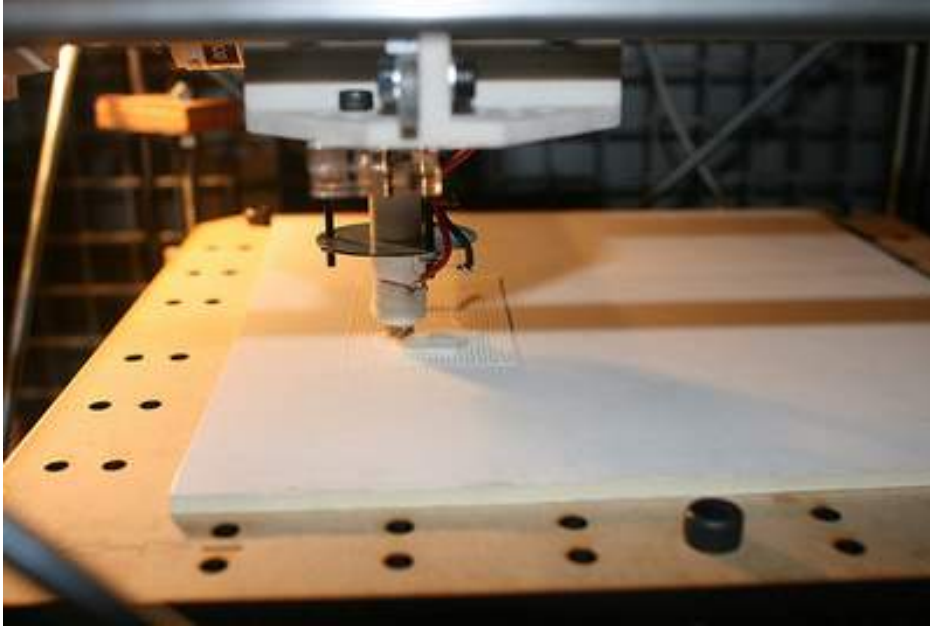

Whew! I'm back from Interactivos '09 in Madrid where I was leading the project to build a rewrap machine. It was a really fun, really intense 2 week project where we built an entire, functioning RepRap machine from scratch (well, sort of... we used PCBs and printed parts)

I'd like to give a big thanks to the whole Medialab Prado crew. They are really some awesome people over there doing some really rad things. They made me not ever want to leave Madrid. The city and people and culture they have there are really something to be proud of. It sort of makes my hometown of NYC seem a bit backwards. ;)

Here's a quick brain dump:

- * tornillas = bolts
- * tuercas = nuts
- * canas = hangover ;)
- * tapas = awesome :)

RepRap machines **can** be built from parts made on a Z Corp machine, but its tough and you have to be careful. We broke some parts and had to hack together some replacements.

It was really cool to use the machine to print out parts to fix itself and thus improve build quality. We broke the Z motor coupling and cobbled a fix together with hose clamps and heat shrink tubing. The Z axis had some major wobble. One of the first parts we printed was a replacement Z motor coupling from ABS. we put it on and the wobble improved dramatically. Yay for self-replication!

I learned how to do 3d modeling (gasp! yes, i dont know how to... this project is so fricking huge!!!)
I learned about Sketchup, Blender, and how to make the two play nicely (blog post coming soon)

Edit: I also learned a really cool technique for doing embossed lettering on printed parts. Blog post coming soon.

Anyway, big shouts to my collaborators: Catarina, Ricardo, Guillermo, Kirsty, Erica, Christine, Juan, and everyone else who stopped by to pitch in that I have forgotten.

Cheers,
Zach

RP Pinch-wheel Extruder II

Tuesday, 17th February 2009 by Adrian Bowyer



It does turn out to be possible to knurl a stepper shaft (see blog immediately below). As you can see, I had to take the rotor out to do it. Minus point: needs fancy kit (knurling head, lathe). Plus point: only took a few seconds, so someone could do hundreds in an afternoon. The new extruder now has one fewer parts...

Tip: clean it really really thoroughly before you re-assemble the stepper...

Here's a vid of it working with ABS:

[RepRap direct-drive stepper extruder from Adrian Bowyer on Vimeo.](#)

See how fast it runs! Note how it stops and starts on a dime! Of course, the faster we extrude the faster we can build things, and - what's more - the less significant dwells and melt ooze become.

If I may be permitted to quote Zach: Yay!

IR Ranging

Wednesday, 18th February 2009 by Forrest Higgs

In which your narrator dodges the whole issue of computer vision...

As I mentioned some time ago, Tommelise 2.0 has gone into production mode as a CNC milling machine ... until I get bored and build an extruder. Mind, my plan is to use Tommelise 2.0 to make the parts for a much cheaper Tommlise 3.0. In that one, the expensive Haydon linear steppers will be replaced with rewrapped ones driven by cheap tin can steppers.

One of my original motives for getting into Reprap was to get the technical background to fulfill a lifelong ambition, acquired at University, to print buildings. Printing large objects presumes that the product is much larger than the tools that make it. My inspiration stemmed from the recently deceased Professor Wolf Hilbertz, whose design studio I took as an undergraduate. Wolf conceived of the built environment as being both automatically constructed by extrusion machines. Similar machines would reclaim the materials of buildings no longer needed and use it in constructing others. His seminal thinking on the subject was published in Progressive Architecture in 1970.

Wolf conceived of quite large machines building whole cities. My ambitions at the time were much more modest. My idea was for very personal spaces being built by a small swarm of machines no larger than shoe boxes. Interestingly, Dr. Bowyer entertained the same notion some years ago and went so far as to get his ideas off of paper and into reality after a fashion. He was kind enough to link me to his own work in this area recently.

One of the big issues when designing extruding 'bots is figuring out where one is. That's nearly so difficult is figuring out where other 'bots in your swarm are so as to avoid crashing into them. About a year ago I happened across a Sharp IR range finding assembly that could, depending on the model, calculate distances out to 5 meters. For starts, I bought a couple of more nearsighted ones that can spot things as far away as 1.5 meters. It struck me that if you put one of these on an alti-azimuth mount run by a MCU not all that different from what we use with our Reprap machines, you ought to be able to map one's surrounds directly in spherical coordinates with very little computing power.

I was at the University of Texas in the 1960's when Professor Agarwal and his graduate student Steve Underwood began trying to reconstruct 3D environments using binocular vision. It was, computationally, horribly costly then. The years since haven't reduced it from being a very wicked problem. How much more simpleminded to simply do rangefinding!

All that had to wait, though, because my first priority was getting Tommelise 2.0 going. I reasoned that with a CNC capability constructing a workable alti-azimuth positioning system would be trivial. As you can see, it was indeed. I designed the parts for a simple system over the weekend and

milled them out in a matter of a few hours.

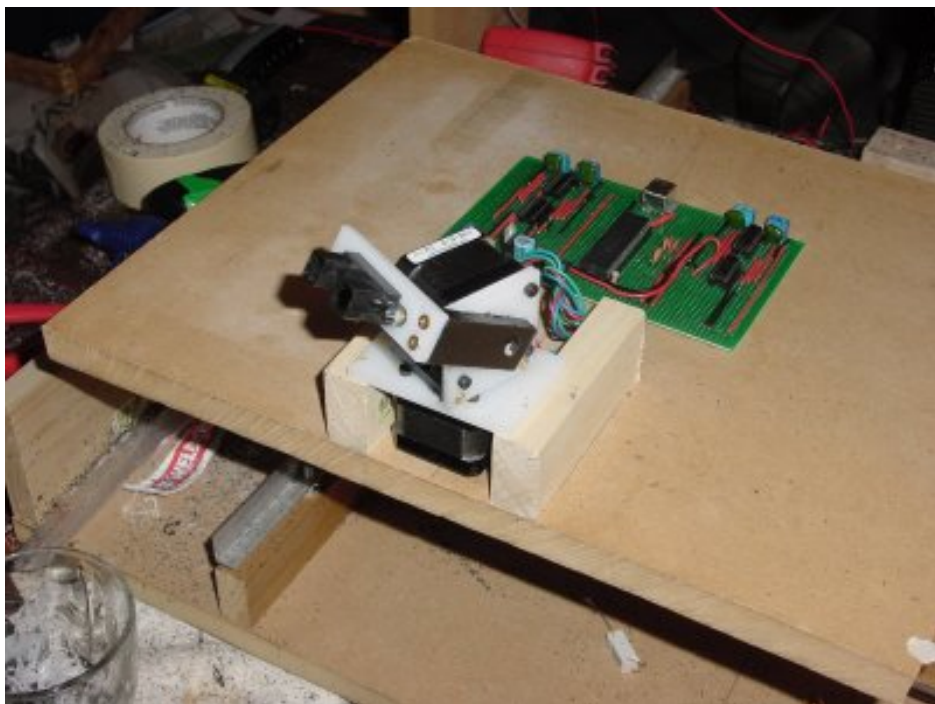

It is hard to describe the bliss one feels when one knocks out a stepper mounting plate in Art of Illusion using shop drawings of the stepper and after milling it discovering that all of the bolt holes are precisely aligned.

I've leveraged the prototype board that I designed to test the I2C slave chip's ability to run a stepper motor via a 754410 into handling two NEMA 17 stepper motors that I happened to have on hand.

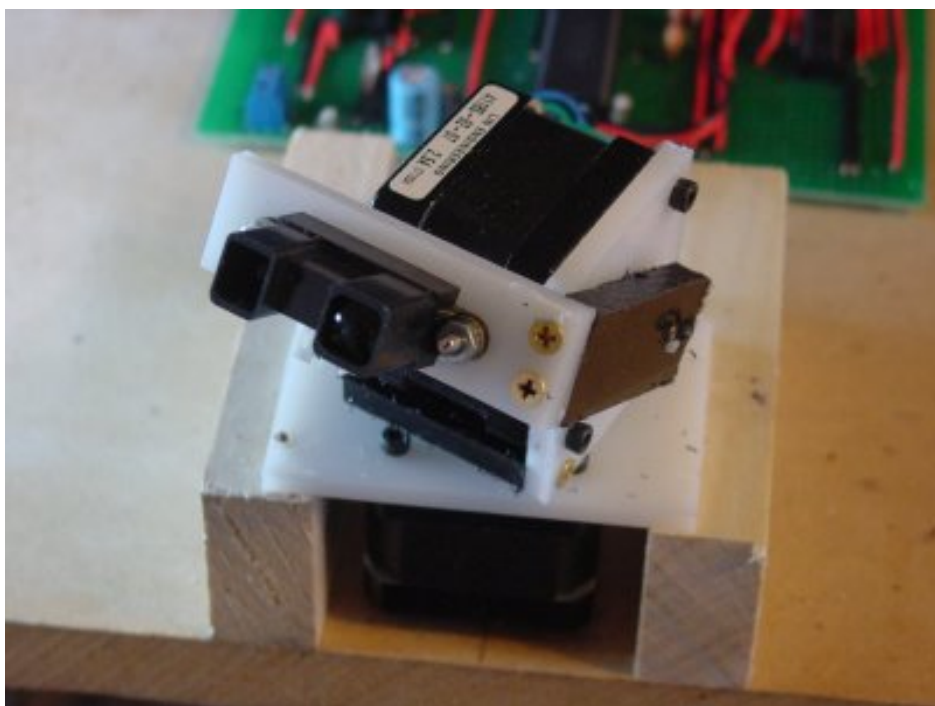

About all that is required on the controller board now is to set a couple of I2C-friendly EEPROMS and finish writing the firmware.

OLPC Viewfinder

Friday, 20th February 2009 by Vik Olliver

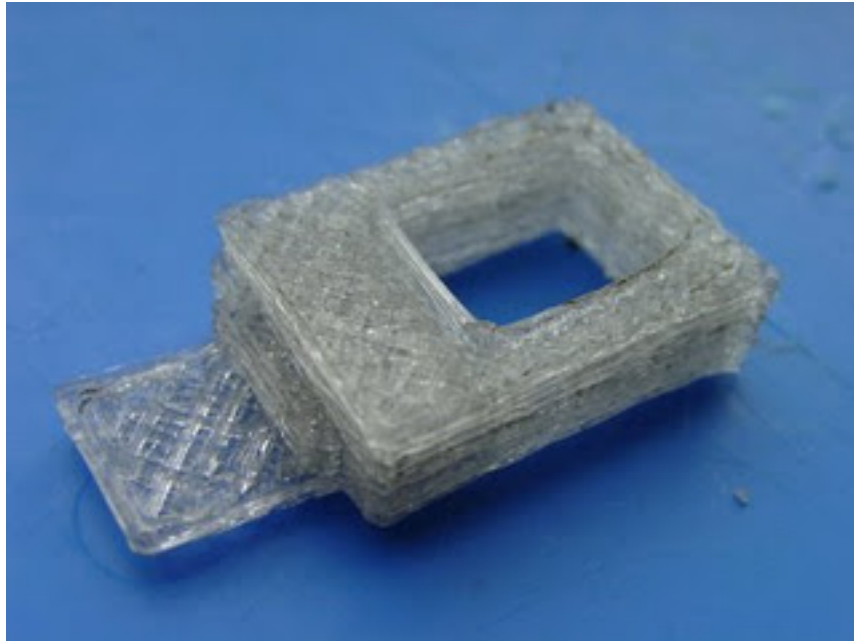

The OLPC XO Laptop for kids has a camera built in to the front of it. Great for video chat, but not so good for when the kids want to point the camera at something that is away from them. There is a commercial viewfinder but now it has been rerapped:



Here it is fitted:

If anyone wants to modify it, the Thingiverse URL is: <http://www.thingiverse.com/thing:330>

Hopefully this is the first of a large number of objects that can be made by schools using a RepRap to further their children's education and enjoyment.

Vik :v)

Stepper pinch-wheel extruder building

Friday, 20th February 2009 by Adrian Bowyer

RepRap stepper extruder working from [Adrian Bowyer](#) on [Vimeo](#).

Here's the prototype stepper pinch-wheel extruder building the coat hook. As Nophead has always rightly maintained, good control of the polymer flow gives the best quality results. This one came out as good as the ones he makes on Hydraraptor. And the slow-running-stepper lights are pretty...

It may also be possible to use a pinch-wheel extruder to drive a syringe - simply put a plastic-coated metal shaft through it, and use that to push/pull the plunger. But because of the large diameter of any useful syringe, the stepper may have to be running so slowly that the output would be a bit jerky. Microstepping may solve that, of course.

Tip: Easy Way to Thread Y Belt

Saturday, 21st February 2009 by Zach Smith

My friend and collaborator Sunil at Interactivos 09 came up with a clever way of threading the Y belt through the Y belt idler assembly. Check it out:

Easy Way To Thread Belt from Zach 'Iowa' Hoeken on Vimeo.

Pull Yourself Together, Bot!

Sunday, 22nd February 2009 by Zach Smith

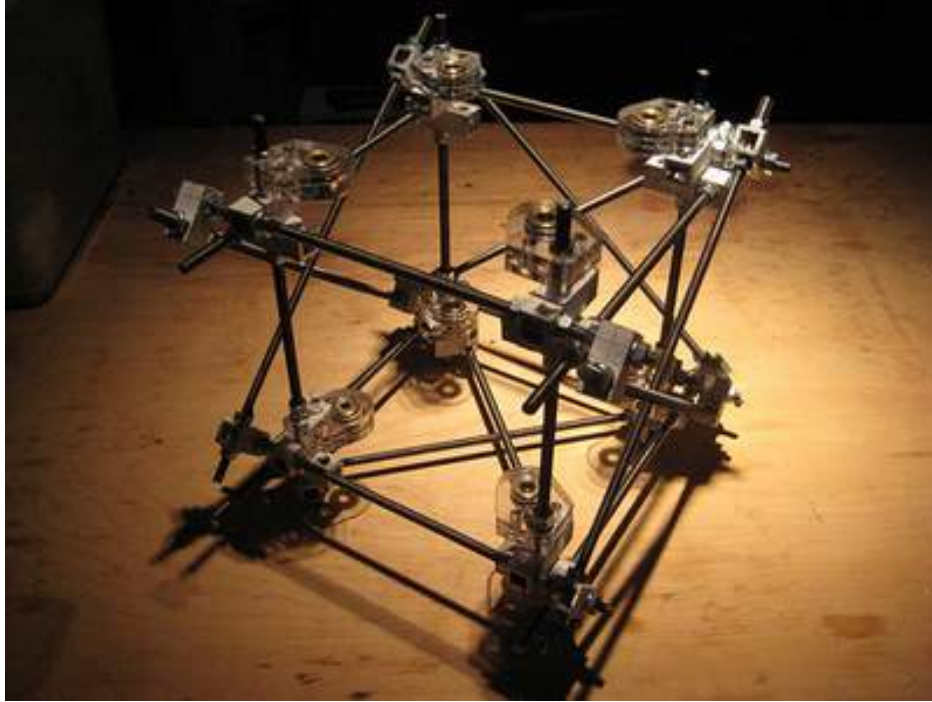

Warning: this is gonna be a long post. Grab a hot cocoa and settle into a comfy chair.

Fresh off a month long RepRap-building workshop binge, I have many ideas to try out and many places to apply polish on the RepRap project. Doing nothing but assembling RepRap designs for the past month has taught me quite a few things, both good and bad. There are many things that we're doing really well on, and a few areas where we can improve on. In particular, the XY assembly is really nice. Skeinforge and the RepRap host software rock, as well as some of the next generation stuff (pinch wheel extruder, gen 3 electronics, etc.) The stuff that isn't quite as easy is the frame assembly, the Z axis, and the bearings (or lack thereof) on the Y axis (on the darwin design).

Anyway, this post is about some experimental work I did this past week that was inspired by those experiences. In particular, it focuses in on two questions that are very closely related:

1. How can we simplify the corner brackets to be easier to assemble as well as easier to print.
2. Is it possible for the machine to be partially self-assembling?

Question #1 was inspired because I've been having a hell of a time trying to print the corner brackets, as well as assembly troubles. Aside from warping issues, the design itself calls for lots and lots of trapped nuts to be placed inside the part. This in turn requires that you have a finely

tuned machine that works exactly how it should to produce them... which is not something most people have. If you're like me, your RepRap machine is sort of hacked together and must be lovingly coaxed into printing what you want. Not only that, but even with commercially produced 3D parts, getting the nuts into the holes can best be described as a dark art.

So, follow me along my train of thought as I present a way of making this part simpler. The corner bracket has 2 main jobs: create the basic structure for a cubic frame, and to be the place for various 'accessories' to mount on, such as the XY axis assembly, z motor, etc. In doing so, the corner block has routing holes for rods going in the X, Y, and Z direction. Basically, its just a part thats full of right-angles. Looking over the rest of the RepRap design, theres a part that I really like: the diagonal tie bracket. It's simple, no-fuss, and easy to print. Not only that, but this guy is basically just a printable right-angle!

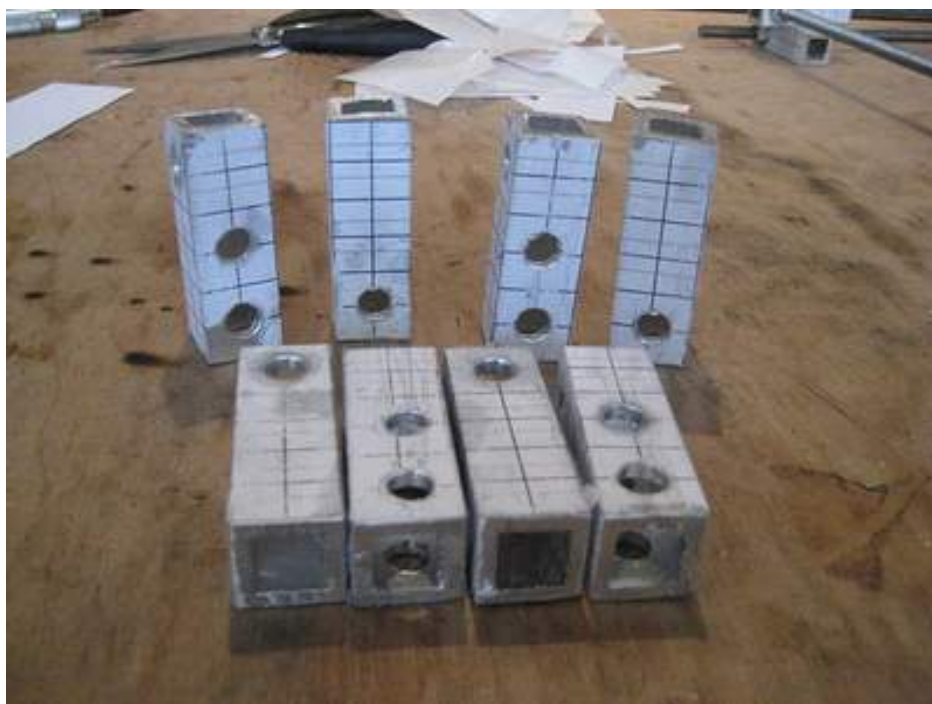

I did a bit of napkin designing on the flight over to Madrid and realized that if you took two of these things, they could substitute for a single corner block by taking two and rotating one 90 degrees. If you had 8 of these parts, then you could make an XY frame. If you had two of those, you'd have the top and bottom XY frame. Of course they will also easily work as the diagonal ties they were designed to be. The only modification you'd need to make is to add an extra hole on the end. Then when they form an x, you'd have three of the four holes you'd get with a single block. This part is pictured on the right.

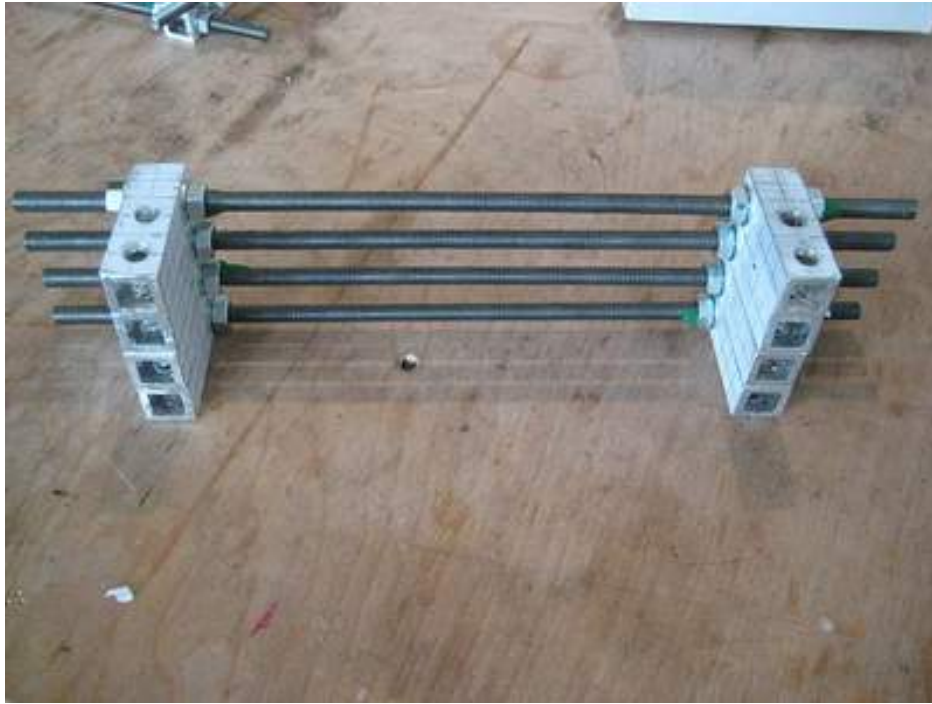

Anyway, so say you get 16 of these parts: how do you turn them into the top and bottom XY frames? Good question. The XY frame is interesting because its basically just rods with corner blocks a certain distance apart. All we need to do is take our corner ties, space them a certain distance apart, and then bingo... we'll have an XY frame. The required parts to form an XY frame is pictured to the right. Astute readers will notice a flaw in this plan though: since the two ties for each corner pivot around the Z-axis it means that the whole assembly is a bit wishy-washy. Even with every single corner tie spaced exactly perfectly, you could easily get a parallelogram instead of a square. How do we make the frame square? Simple! Make a diagonal rod with two ties spaced exactly the right distance apart and attach it to the Z rods so that they form a perfect, right-angle triangle!

Now, I know what you're thinking.... holy crap that sounds awful. I'll have to measure each of these things very precisely and make sure they're exactly correct otherwise my machine will be slightly off and my children will hate me, drop out of school, and then the economy will tank. Well don't worry my friend, because I've managed to stumble onto the answer, and it involves question #2: Is it possible for the machine to be partially self-assembling?

So, is it possible? I say yes! Yes, it is! The answer is that we make the machine do the measuring and we coax it and guide it along. If you have a sharp eye, you'll notice that the XY frame parts above are constructed from THREADED rod instead of SMOOTH rod. The rod used is the same rod that we use for our Z axis, and I specifically got the crappiest rod I could find in order to really test to see if this is viable.

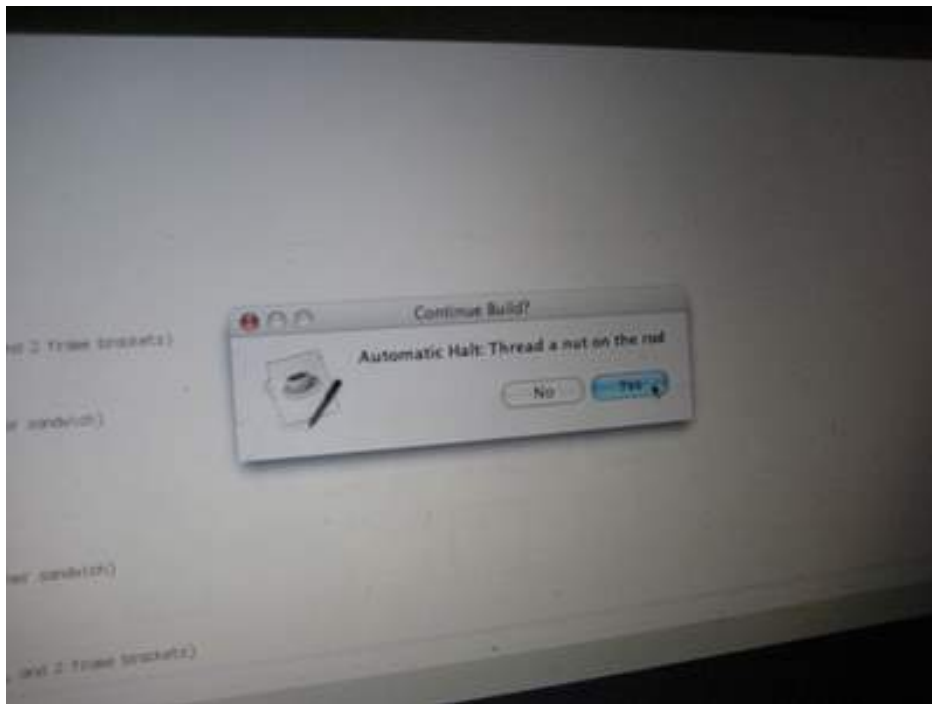

Okay, so how exactly do I propose we have the machine self-assemble? Easy! We use a stepper motor, some threaded rod, a python script, and a few other parts to turn the RepRap technology into a precision kebab-building machine! Here's how it works: I created a reference design in QCad. (which I totally forgot to check into subversion, sorry!) From this design, I created a python script that creates GCode instructions for building the various kebabs. The GCode consists mainly of two parts: instructions that prompt the user to do things: thread a nut on the rod, slide on kebab parts (diagonal ties, washers, etc) and actual instructions that cause the rod to rotate a nut to exactly the right position. The end result is pretty slick: it generates a wizard that serves as both a guide and a self assembly program. You the user just sit back and do what your robot overlord prompts you to do. A screenshot is shown on the right here.

Of course, all this was just a random idea in my head until a couple days ago when I sat down and actually tried to do it. Let me just say this: it works way better than I thought it would! Even with the various inaccuracies I introduced by making my own parts by hand, all the parts still managed to fit together without any jamming, bending, or forcing of parts. my reppap machine is down due to cannibalism for the workshops)

It was really cool to sit down and have a conversation with someone while occasionally following the prompts from the laptop, and ending up with 4 kebabs that were all perfectly spaced and ready for use. It was even cooler to put the diagonal ties created by the same method onto the frame and watch it be pushed into a perfect square. It was even cooler to install the Z kebabs, the second XY frame, and finally the vertical diagonals and have them all settle nicely into place without fuss. The only measuring I did was in cutting the rods and accuracy wasn't all that important there.

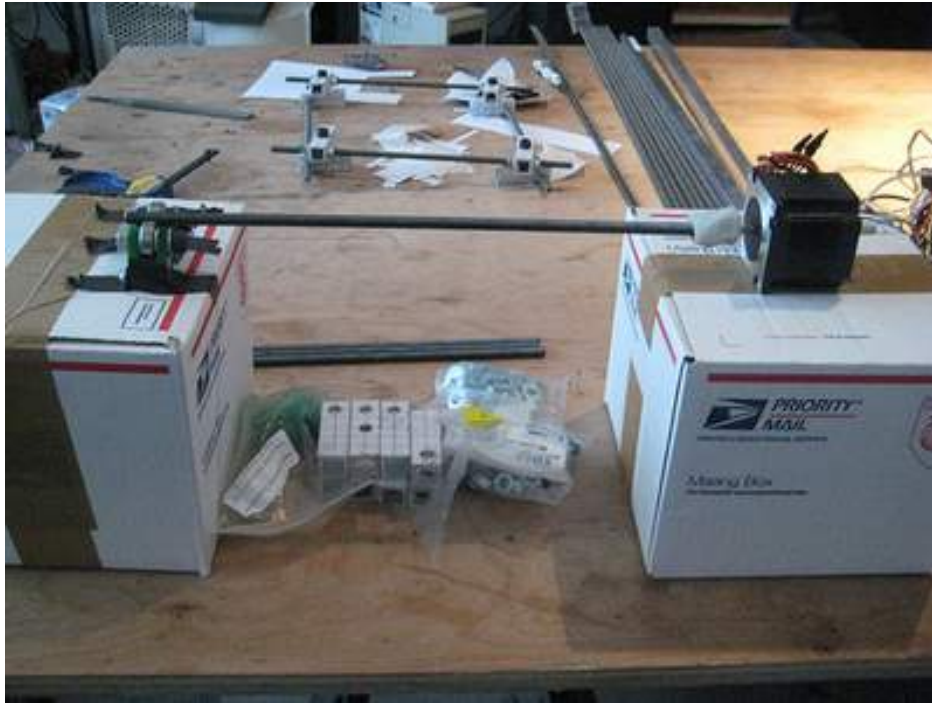

A picture of the rig I used to build the kebabs is on the right. Its just a stepper motor, a motor coupling for the rod, an M8 rod, and an idler to make the process easier. The stepper is hooked up to a standard driver which is hooked up to a RepRap Motherboard which is hooked up to my computer which is running the GCode on ReplicatorG. The only custom part here is the idler to make the threading process easier. Everything else is stuff you'll need to build the machine anyway!!!! I had to hack my own coupling together, but the standard RepRap Z motor coupling would work without any sort of modification. With a bit of clever coding and a re-application of the tools that we already have, it becomes simple to do this.

Now, what are the implications of this? Obviously its a very simple technique that you the builder needs to take part in, so we won't have self-copying robots that self-assemble running amok. However, there are some really cool things that are going on here:

1. the design is parameterized! the python script takes all sorts of parameters that control the gcode that is output. things like X, Y, and Z dimensions so you could build a big RepRap machine, or a small reppap machine! it also takes things like rod size, washer size, and nut size so you can easily convert the script to imperial, or use M5 hardware. it also has some cool options for the build such as leaving out washers, or using thread locking compound for those adventurous souls who never wish to take their machine apart.

2. the instructions are the design! the first 20 lines of the gcode are instructions such as the number of nuts you'll need, the number and lengths of the various rods you'll need, as well as various bits of information such as volume diagonal lengths, etc. not only that, but as its an interactive process, it makes assembly a snap: you simply follow the step-by-step instructions and the various parts go together in front of your eyes. no more digging through complicated build instructions. just connect the dots!

3. we can do lots of other cool things: dynamically generate a DXF template for the bed? sure! dynamically generate STL files for the diagonal ties? sounds awesome! one day you may be able to use the same script to generate a miniature reprop for building ant-sized things or to generate a reprop for building buildings! these things still need to be implemented, but the framework is there.

Now, what about the drawbacks? There are definitely a few issues, and it certainly isn't the technique to end all techniques. Here are a few off the top of my head.

Problem: The starting position of the nut is crucial. I eyeballed it and got good results, but it certainly is a source of error. It should be at the exact same position at the beginning of every move. My solution: create a 'nut starter' device that acts like an endstop, and then have the stepper 'home' until it hits it thus ensuring every nut starts at exactly the right place.

Problem: Once a nut is positioned, minor rotations can move it out of position. (ie: 1/2 turn on M8 rod is 0.625mm) This can happen accidentally, or to the previous nuts when you rotate the next ones on. My solution: use a bit of modeling clay (or blue-tack) to hold the nut into place until you can tighten it down. It seems to work pretty well.

Problem: If your rod is dirty, or the thread damaged then the nut can slip from your fingers as the rod is rotating, causing you to lose your position. This really sucks, because GCode doesn't have any real support for moving back or re-executing a command. It's not totally fatal however, because most assemblies have two nuts: a front one and a back one. If one of them slips, you can use the other as a datum. Its best if you don't let the nut slip. My solution: put a bit of oil on the rod before threading nuts, as well as running a wire brush just ahead of the nut on the first pass for a rod. Long-term, it would be nice to make a little carriage that holds the nut in place and allows you to do other things while its automatically placing it.

Anyway, it's probably about time to wrap this post up. This was a fun experiment and I'm very happy with how it turned out. It's still very much under development, and I'll be hacking on this quite a bit in the coming weeks. I think its a very promising path for development of the reprop project. If you'd like to play along, or just check out the work that I'm doing, I store everything in my [reprop subversion folder](#). This particular project is codenamed 'Pythagoras' because its based on triangles and also because its generated using a Python script. The project specific scripts and drawings are located in [hoeken/pythagoras](#). You can also check out my [flickr set](#) with a few photos. I was too excited to take more, but if this turns out to be a really good path, you can be sure I'll fully document the process.

Thanks for reading, and I look forward to your comments.

PS. the very first picture is the prototype frame i assembled. its exactly 330mm x 330mm x 330mm

outside dimensions. i plan on building a much bigger one in the future as well.

Racks and pinions

Sunday, 22nd February 2009 by Forrest Higgs

Wherein your narrator explores ways of upping the milled or printed content of future Reprap machines.

Some years ago I wrote a script in Java for designing involute profile gears on a dare. Having successfully done that, I went on to do another script for designing racks as a companion for the gear script. While I've tried out the gear script on a number of occasions in the past half-year, I'd yet to try the rack script.

Now I have.

I wanted to mill fairly fine toothed racks and pinion gears. Attempts to do that revealed some problems in my toolpath calculations which I've got some way towards solving. As well, I had a scaling problem in the Slice and Dice routine that I knew about but hadn't had an occasion to want to fix till now. I chased through the coding and parameterised the scaling factors. Right now I have it scaled to 240x240 mm at 0.102 mm resolution. That let me attempt a 190 mm rack {200 mm milling area}.

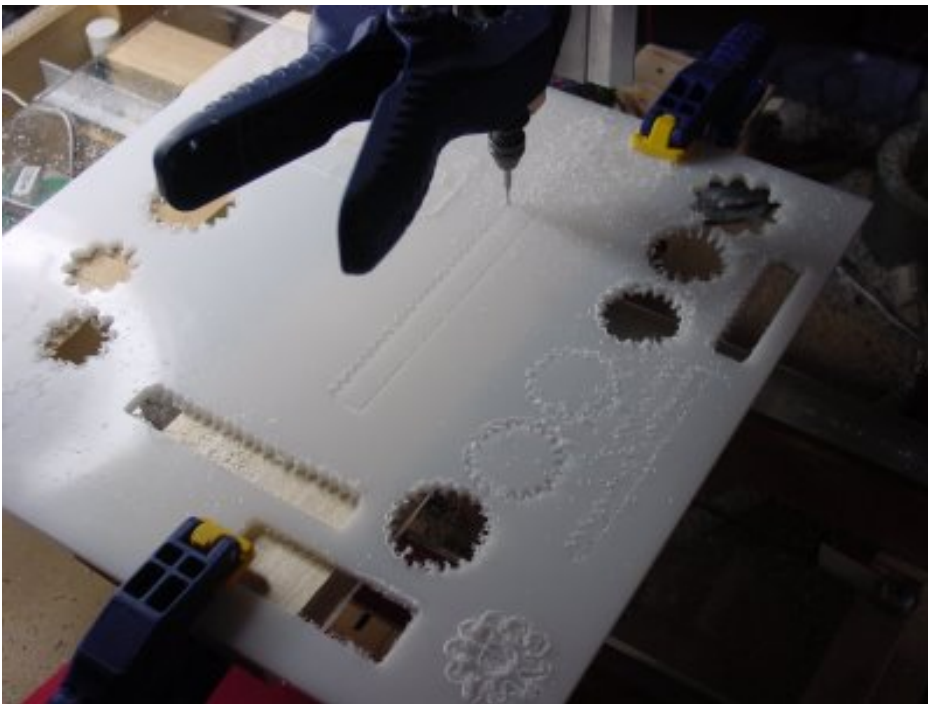

There is no practical reason why I can't do a diagonal cut on a 12x12" sheet of HDPE and get several 15" racks.

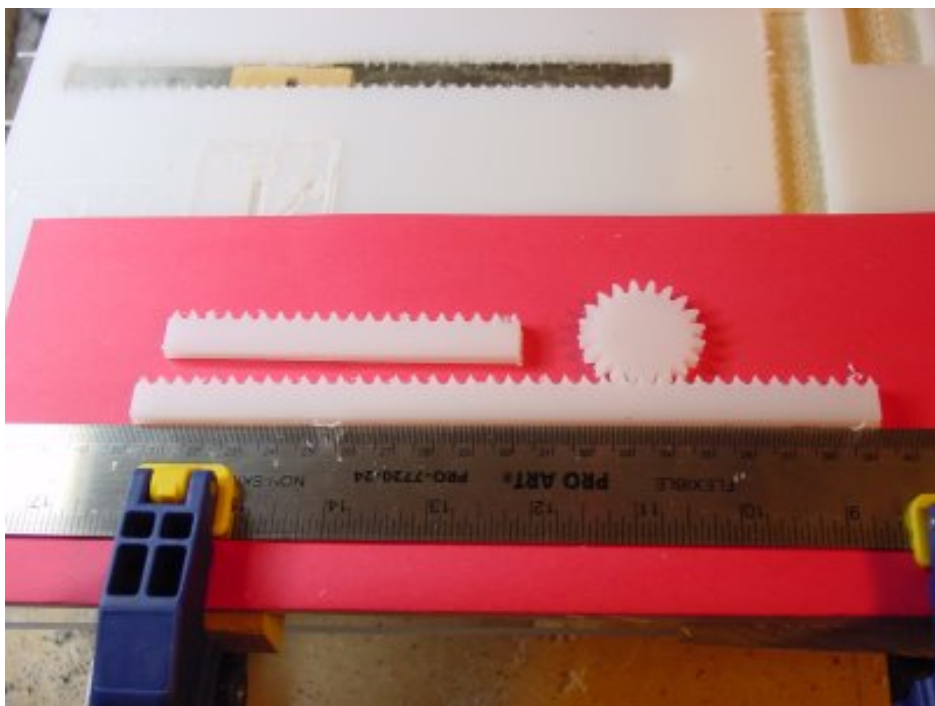

I could either tilt the axes slightly to get rid of backlash or offset and springload two parallel strips of rack to achieve the same effect.

Don't take the product you see here too seriously. I cut it with the brutal Airpax steppers that I just took delivery on in mind.



After doing this, however, I've reached the conclusion that the diminutive Jameco steppers would be better suited to this approach.



The Airpax steppers I intend to use for a geared linear stepper approach.

Wedge Design Proof Of Concept

Sunday, 1st March 2009 by Vik Olliver

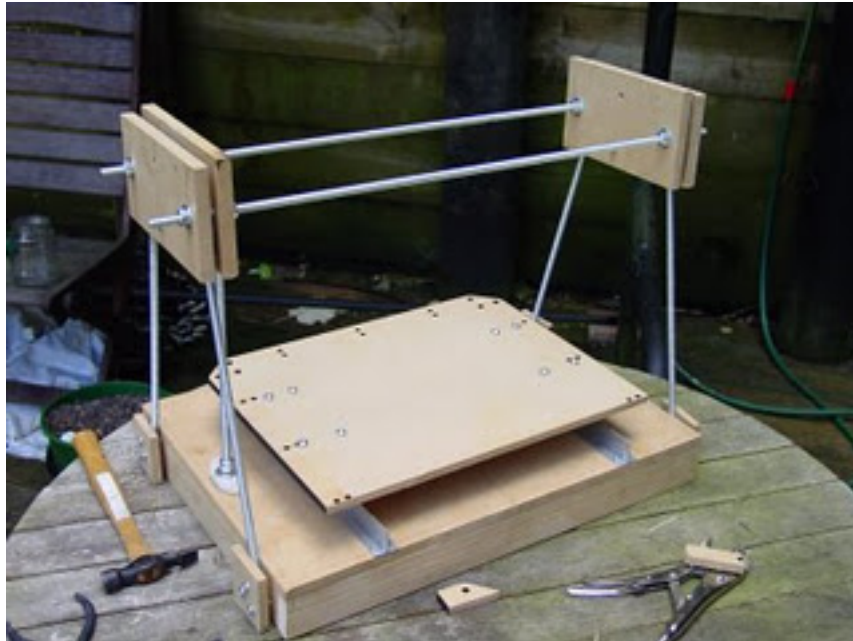

Ed has been discussing a proposal for a wedge-shaped version of the RepRap, using fewer components and being more easily manufactured than the existing box frame. One of the things we wanted to know was how badly it needed cross-bracing. So, I sliced & diced some MDF to give us an idea of how things might be spaced out, and to experiment with the bracing so I can have the rigidity and still maintain the same build volume as a Darwin.

Well, just 4 struts definitely isn't a stable design. Things wave about quite a bit under moderate load - which bodes badly for movement at just the wrong vibration frequency. Further mucking around revealed that this could be much reduced by bracing and I'm still fiddling with that to see how little I can get away with.

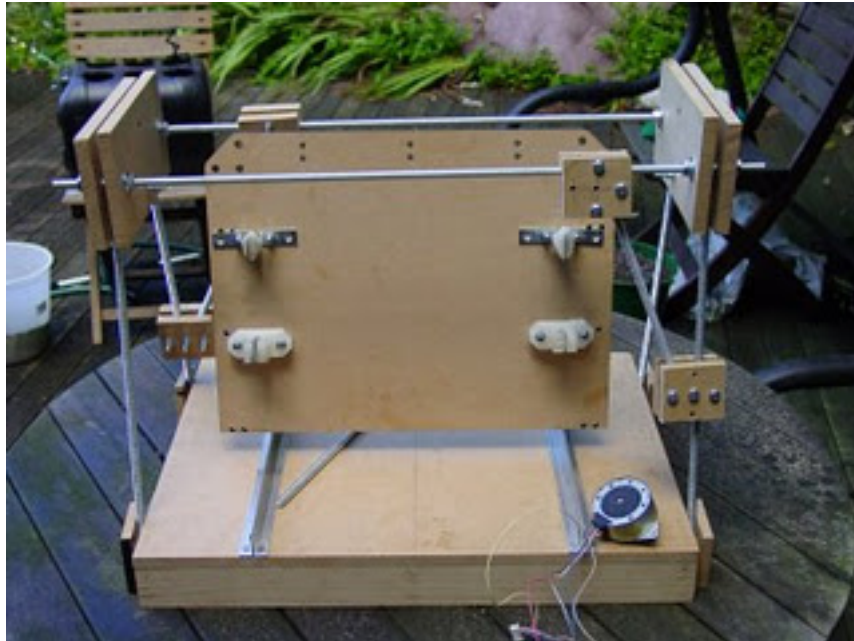

Here's a shot showing the underside. Two of the X sliders are RepRapped by the way, and two are made from galvanised corner brackets and Polymorph. I thought it might be a good idea to make as many parts as possible in a way that could be replicated by hand if necessary.

I'd like to have the option of moving the axes with either motors & belts or threaded rod in the next design. In some parts of the world, high-quality steppers are unobtainable and so it makes sense to leave the path open to using current stepper/belt systems, develop DC-servo systems, and if all else fails drive it with a slow, old-fashioned threaded rod.

I'm not expecting this particular model to actually move properly, but if it does it'll be a really cheap way of putting RepRaps together.

Vik :v)

Thingiverse Tools System Released

Monday, 2nd March 2009 by Zach Smith

I've been working on a new feature called Tools for Thingiverse lately which will make it much easier to find things to build and just make it a bit more tidy in general. For example, here is a page that lists things you can build with a RepRap machine.

If you want to know more, check out the Thingiverse blog post, or the newly discovered Tools Galaxy.



Things you can make with a [Laser Cutter](#)

Showing 1 to 9 of 60 things



[Flatpack Monkey](#)
By: [bre](#) 4 months ago



[Servo Controlled Switch](#)
By: [comlout](#) 1 month ago



[Icosahedral radiolaria](#)
By: [phooky](#) 4 months ago



[DIY Glasses](#)
By: [daewoo-tech](#) 3 months ago



[Oval Gears \(Offset\)](#)
By: [Billion](#) 3 months ago



[Basic Pentapod](#)
By: [phooky](#) 3 months ago

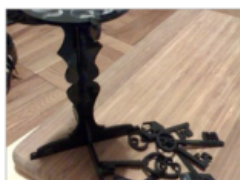

For now we see through a glass, darkly...

Monday, 2nd March 2009 by Forrest Higgs

In which your narrator's short-range IR radar set begins to return images...

There are so many things that want doing and so little time available to do them.

This weekend I spent my spare time knocking the short-range IR radar set I'd built using milled fittings from Tommelise 2.0 into shape. The friction fits between the NEMA 17 stepper shafts and the HDPE bits weren't robust enough and slipped, so I tried JB Weld to solid that all up. It answered well.

I won't relate the trials and tribulations of getting the Sharp IR rangefinder integrated into the system. It was tedious, but I finally got things working relatively well and the firmware brought up to speed. It's not perfect, but it works well enough for testing.

The Sharp sensors came from Acroname. They have a [little article](#) about how to convert the voltage signal from the sensor into range data. I found it to be totally useless. Here is what the signal vs range profile sort of looks like.

Fig.3 Analog Output Voltage vs. Distance to Reflective Object

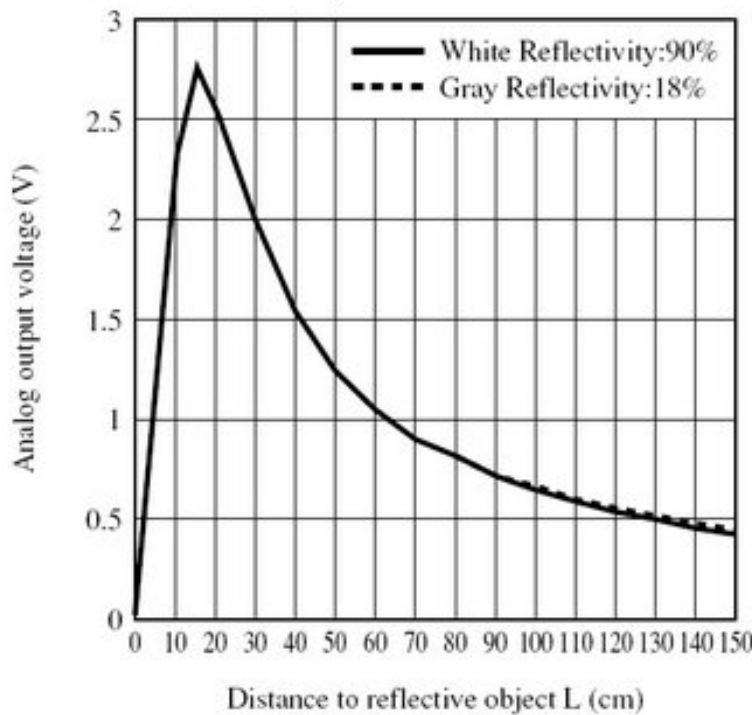

I spent some time calibrating the sensor and derived this chart.

GP2Y0A02YK calibration

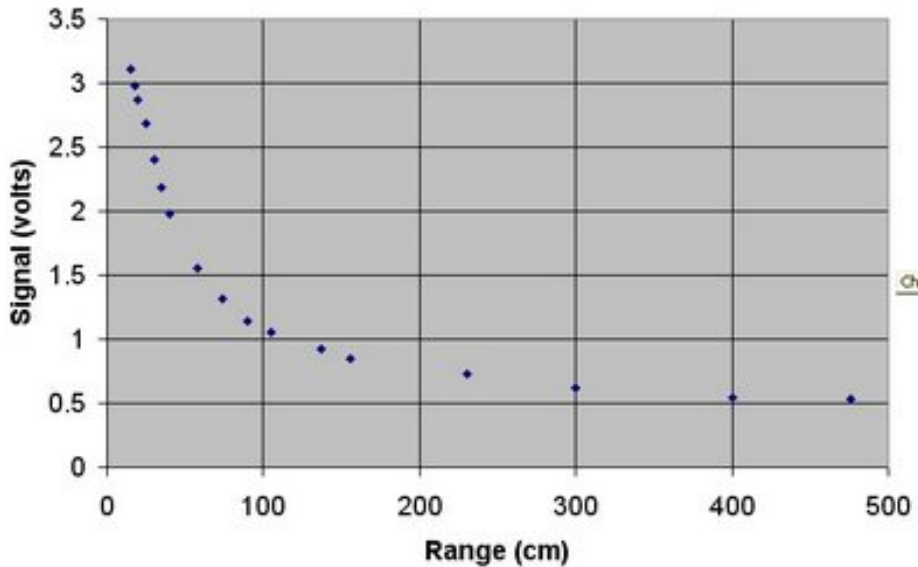

As you can see the one doesn't bear a whole lot of resemblance to the other. One bit I left out was the fact that when you drop below 15 cm in range the voltage drops off. I measured that, but left it off of the chart you see that I created.

The sensor is specified to be good out to about 1.5 meters. In fact, I was able to detect significant voltage differences out to four meters. What my calibration curve doesn't tell you, however, is that in practice, readings of objects further away than 1.5 meters with this sensor tend to be pretty noisy. One interesting phenomena I observed was that at those distances the sensor tends to return distances enormously closer than reality when the IR spot crosses a relative sharp corner of an object. Getting a scattered return tends to spoof the distance measurement electronics.

Once I figured that out I tried imaging nearby objects



Here you see a carton I used as an object to scan and here you can see a bit what it looked like to the radar set.



Once I had the data from the scan I realised that I had what is known as a "point cloud" to deal with. Looking around, I couldn't find any apps to turn it into a mesh that I could image, so I finally wrote my own routine to turn the point cloud into an STL. That wasn't as big a chore as I thought it would be when I resolved to do it. In fact, having my own code I was able to put in a distance filter to remove noisy returns from features more than 1.5 meters away.

Here you can see the STLs presented in the open source Meshlab app. I was able to get Aol to do the job, but the Meshlab image is easier to look at.

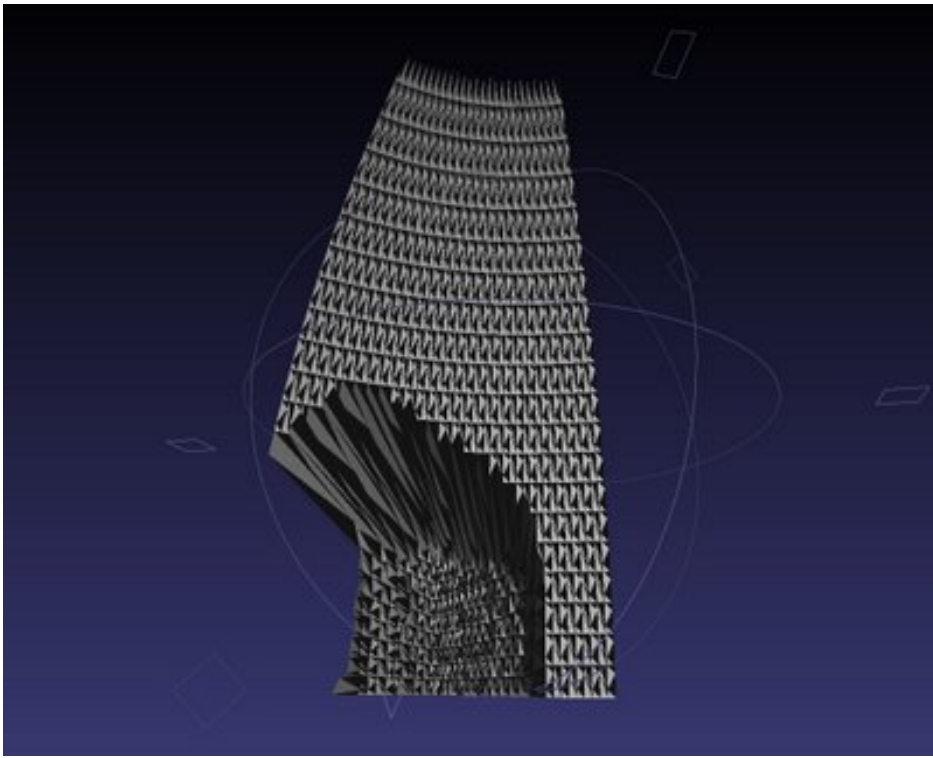

Front view of the carton.

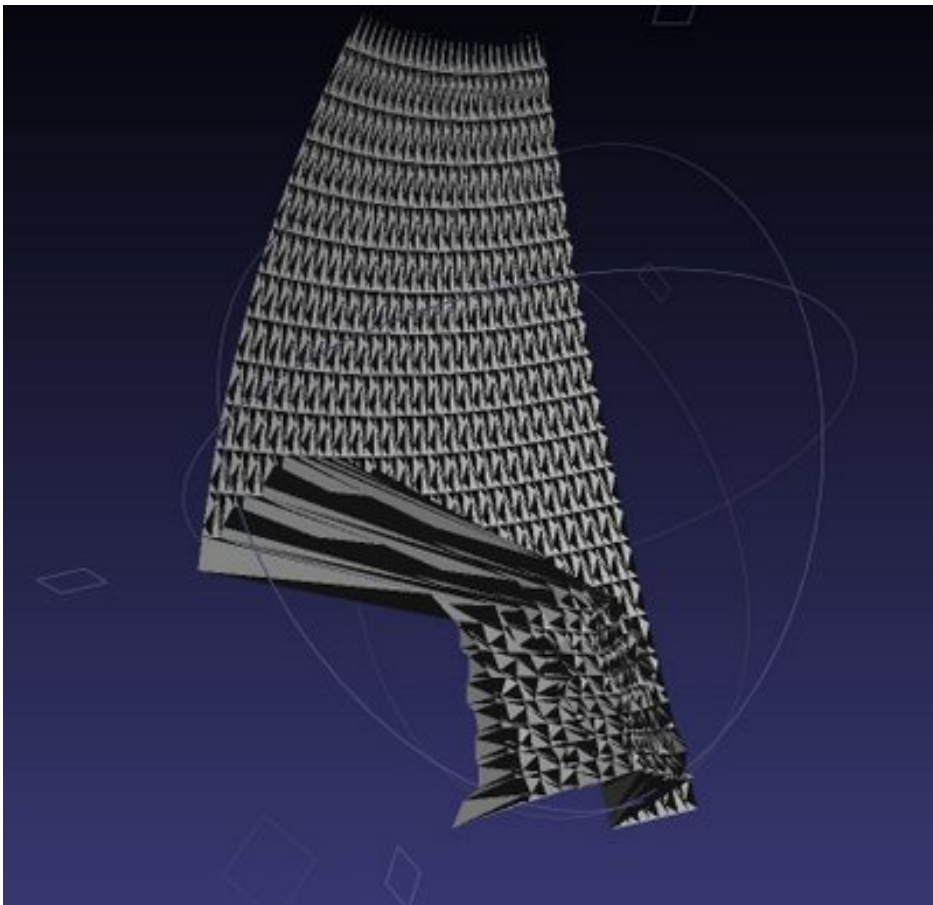

Right side view.

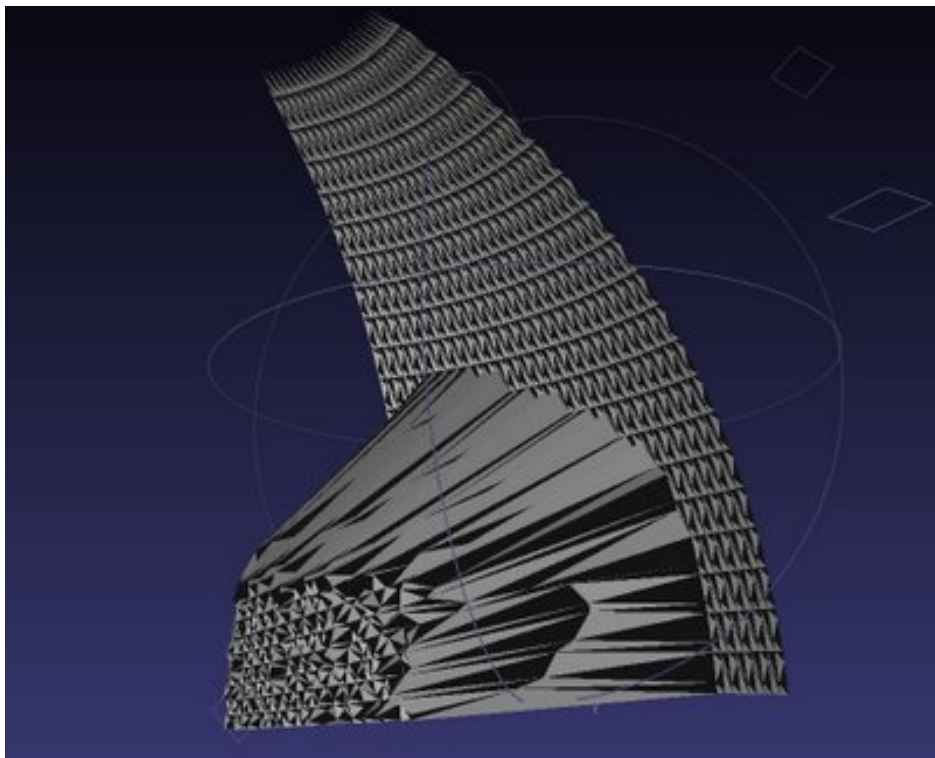

Left side view.

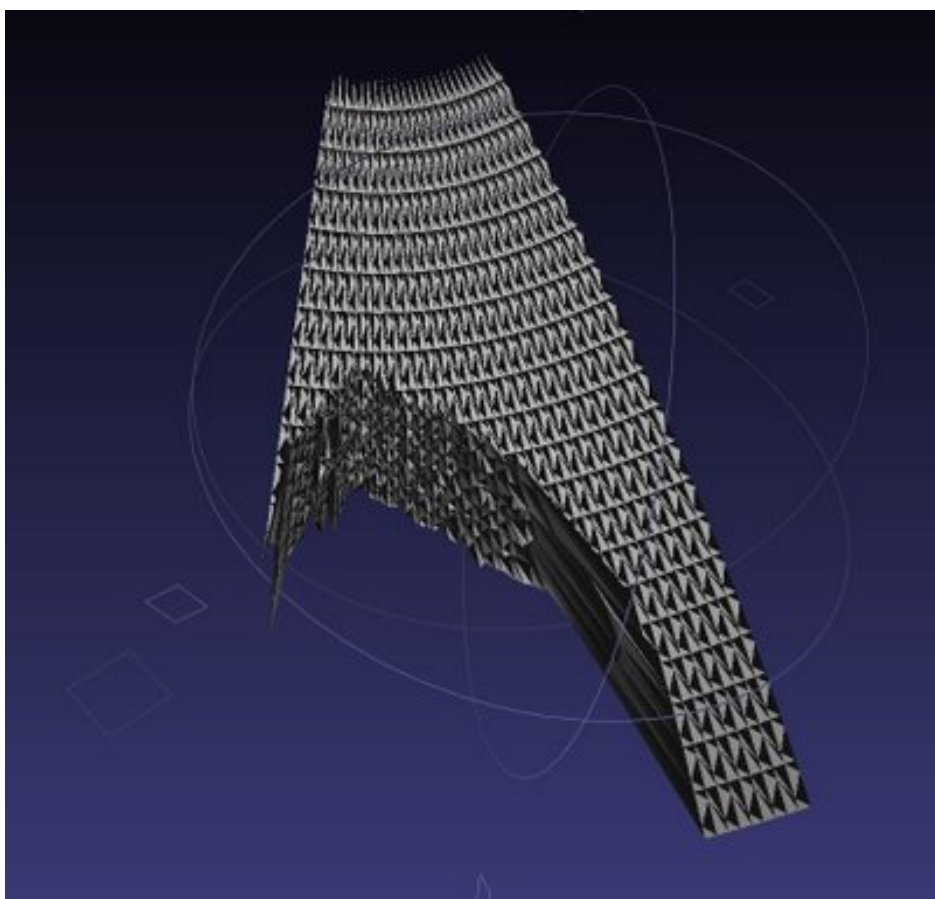

...and the view from the underside.

The image was generated using half-degree steps in the scanner. The sensor appears to have an D:S ratio of about 30:1 which is pretty good. Matt at Acroname told me that you could image the IR spot with a digital camera. I wasn't able to make that happen with mine, however.

The next step I have to make is taking real-time measurements of the reference voltage that I am feeding into the sensor to see if some of the signal noise I am seeing results from my just assuming that it is five volts. Beyond that, I am probably going to buy a few Microchip MCP3425 16 bit A/D chips that are I2C interfaced. At just a few dollars that chip appears to be real value for money. It does reference voltage monitoring automatically as well as giving you 16 bits of accuracy.

Whether that complexification is going to be justified with this sensor, however, is not clear to me at this point.

I am tempted to get one of Sharp's GP2Y0A700K0F sensors which are supposed to really give you good measurements out to 5 meters. They only begin to give you a useful signal for objects further than a meter away, however. I would have to use one in concert with one of their shorter range sensors like the one that I am using now to get full coverage.

Wedge Design Bracing

Wednesday, 4th March 2009 by Vik Olliver

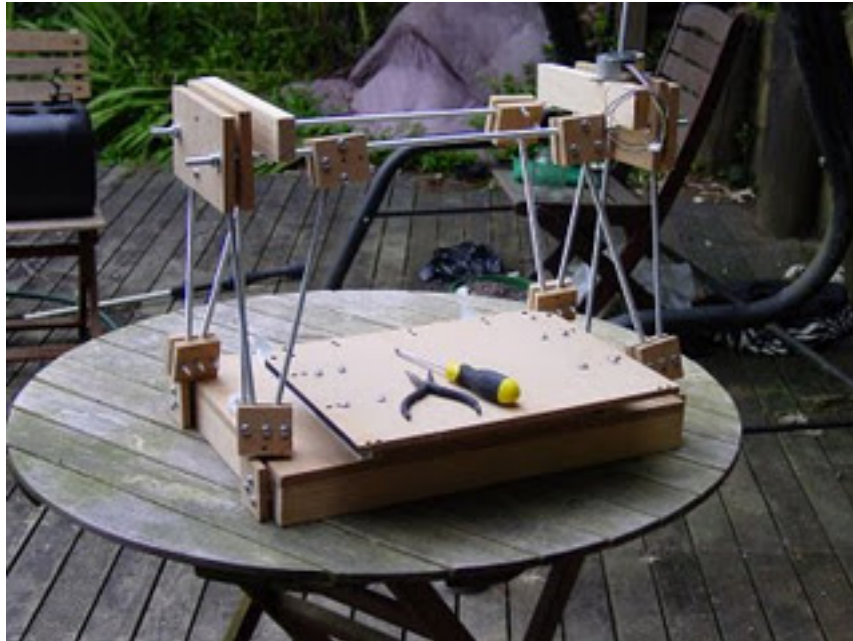

I've been finding a few moments to cut & fit M8 bracing to the Wedge wooden prototype (The Wedgewoods were a good friend of Darwin BTW). Four lengths of 325mm (could probably go to 330mm) seem to make it stiff enough. I discovered that 5 holes in bits of MDF turns them into handy clamps that work at a variety of planar junctions. The top of the horizontal threaded bar is 305mm above the upper surface of the base, in case you want some scale.

I've roughly laid out where the vertical Z axis drive rods will go (like the reprop'd bearing holders?), and a possible place for mounting the Z motor - maybe a little closer to the horizontal crossbars though. For the moment I'll drive the 2 vertical shafts with printable Z gears as used in the Darwin Child, but might switch to a driveshaft or at least give one as an option to avoid buying chain. Using a driveshaft would require 2 more bearings, reprop'd gears and more threaded rod but I can see some people might want to do it.

Now which to do? I want to work on the paste extruder, the Wedge Y axis and the Wedge Z axis (which will have to evolve in parallel with the X axis and carriage). Place your votes while I go to First Responder training...

Vik :v)

Vitamins and minerals

Thursday, 5th March 2009 by Forrest Higgs

In which your narrator takes a bit of a different direction vis a vis the question of replication...

This isn't one of those stories that you that has a beginning, a middle and and an ending. I didn't really start out to do what I'm blogging here. Actually, I wanted to design a printable linear stepper motor. Tommilise 2.0 uses excellent, but expensive (~US\$75/axis for stepper and lead screw). They are rock solid and accurate. They do have a bit of an Achilles' heel, though. Their lead screw is a bit thin and flexible for serious milling.

I set out, therefore, to somehow put together a linear stepper with a heavier lead screw. That's where I started. It quickly became apparent that this was a pretty big job and so far I've come at the problem from several directions which I will not recount here. That said, I've been worried for some time about the direction that the mainstream Reprap project has taken in the past year. I commented on that a bit earlier.

When you scrape away all the nonsense, however, my worry has been that Darwin just isn't replicating. It's getting made with laser cutters in short production runs. Not to put too fine a point on it, it has become a disassembled industrial product, not unlike an Ikea sofa. Now that's fine, as far as it goes. It gets a lot of Darwins out in the field and gives a lot more people a chance to participate in the designing of a next generation Reprap machine that actually CAN replicate easily.

Recently, eD at Bath University has been designing something that I think falls somewhere between Darwin and Mendel. More recently still, Vik has been knocking together mockups of eD's design to work the bugs out of it. Vik and I began our respective systems using lead screws made from readily available studding {threaded rods}. Darwin took the direction of using belts. I won't get into the relative merits of the two approaches. That ground has been gone over any number of times in both the blogs and the forums.

What I will discuss is that both Vik and I have been rather... perturbed is probably far too strong a word, but lets leave it there for now, about the dependence of mainstream Repraps on NEMA 17 and NEMA 23 stepper motors. The bottom line is that while they are wonderful pieces of engineering, they're rather expensive and, more importantly to both of us, they're bloody difficult to lay hands on if you don't live in one of the G-7 {I'm not sure about Russia} countries or China.

Now Zach, at the RRRF, has moved Heaven and Earth to get the cost of the NEMAs on Darwin down to something reasonable. US\$25 for a NEMA 23 is a brilliant deal ... if you're in the US and the RRRF has stock. If you're not, you find yourself twisting in the breeze. If you are serious distances from the US the shipping cost of NEMA 23's gets to be a real problem. Vik tells me that

you can lay hands on a NEMA 23 in New Zealand for about \$100.

On the other hand, tin can steppers are pretty easy to lay hands on pretty much anywhere, either new or salvaged. Vik can buy a pretty nice tin can stepper new in Auckland for about US\$14. I can do the same thing for about \$12.50. These are typically unipolar puppies with either a 15 degree or 7.5 degree step. With a lead screw approach that kind of stepper can get you considerably better than 0.1 mm positioning accuracy. They are a touch slow, however.

One of the approaches that I took to designing a linear stepper was to take a 15 degree tin can stepper motor, tin can is a pejorative term for permanent magnet stepper, and slap on a gear pair onto it that makes sure that the positioning accuracy is about 0.1 mm instead of a lot less than that. I decided to use 3/8-16 studding which is extremely common here for the lead screw. The gear pair to get a 15 degree stepper motor to yield 0.1 mm positioning accuracy is about 1.6:1.

Vik and I began to informally pursue a tin can stepper/lead screw solution a few weeks ago. I snooped around on the web and scored half a dozen old Airpax steppers on the web at a true Scots-Irish price of \$2.50/stepper.



These Airpax steppers are heavy duty ones weighing a half pound each. They are so many of them around used because they were a part of the old DEC minicomputers twenty-odd years ago. You can get this stepper from that era new in the box for about \$5. I've found listings for them in Spain and South America among other places. The same stepper is still made by Portescap {part of Thompson and Danaher Motion} for about \$23.50. You can get knock-offs from China for less than half that.

This is not to make a case of this is the stepper that should be used. There are a bunch of different

ones that could do the job easily. It just happens to be the one I chose.

Anyhow, I was busily trying to shoehorn one of these Airpaxes into a gearbox for a linear stepper drive when it suddenly occurred to me yesterday that I was focussing on entirely the wrong problem. What I should be focussing on was making something very conventional that was easy to make. Vik favoured using the tin can steppers to turn lead screws rather than turn a nut on a lead screw. A few calculations led me to the same conclusion. The Airpax weighs about half a pound. So does a foot and a few inches of 2/8-16 studding. It really doesn't matter whether the studding moves or the Airpax or the studding rotates. Probably rotating the studding takes the least energy.

With that in mind I took the gear pair that I'd milled and knocked together a lead screw mockup not all that unlike what Vik had done with eD's design.

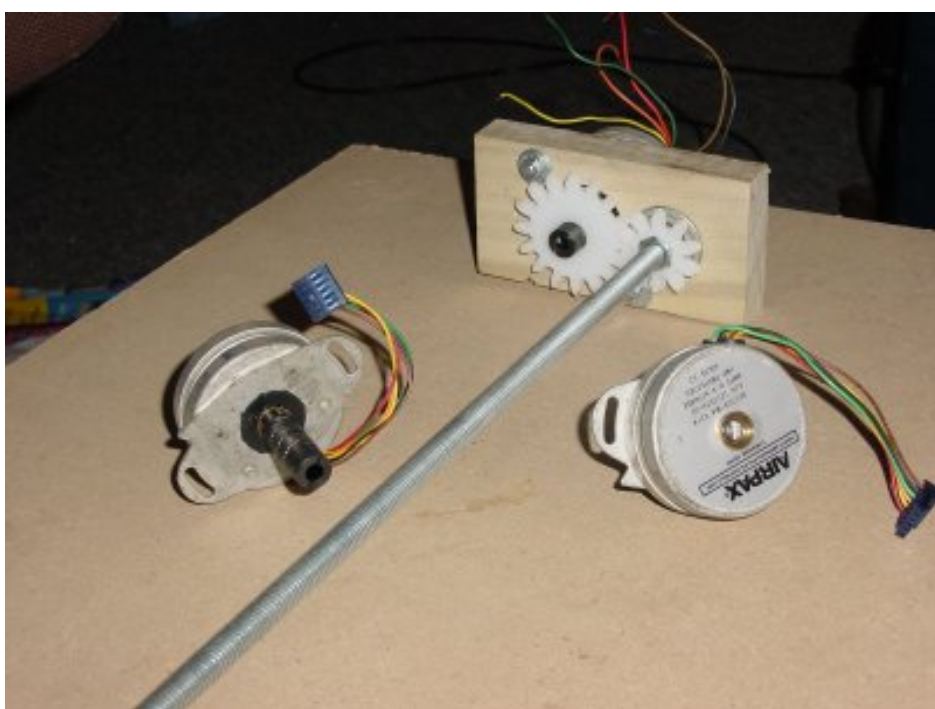

Here you can see the whole ensemble...



Here's where things get interesting. Traditionally, while Adrian has referred to "vitamins" as the bits that a Reprap can't print, viz, things like steppers, IC chips and the like, we've had an informal and unspoken definition of vitamins as being the bits you can't acquire locally. When I first joined the Reprap project at the beginning of 2006, Adriaan kindly forwarded me a set of printed parts for a Mark II Extruder plus a gearmotor to run it. The rest of the Mark II I was able to acquire locally. Eventually, I wound up with Tommelise 1.0 and 2.0 from that little box of vitamins.

Now, look at the first picture of my hacked lead screw drive. The vitamins are that gear pair.

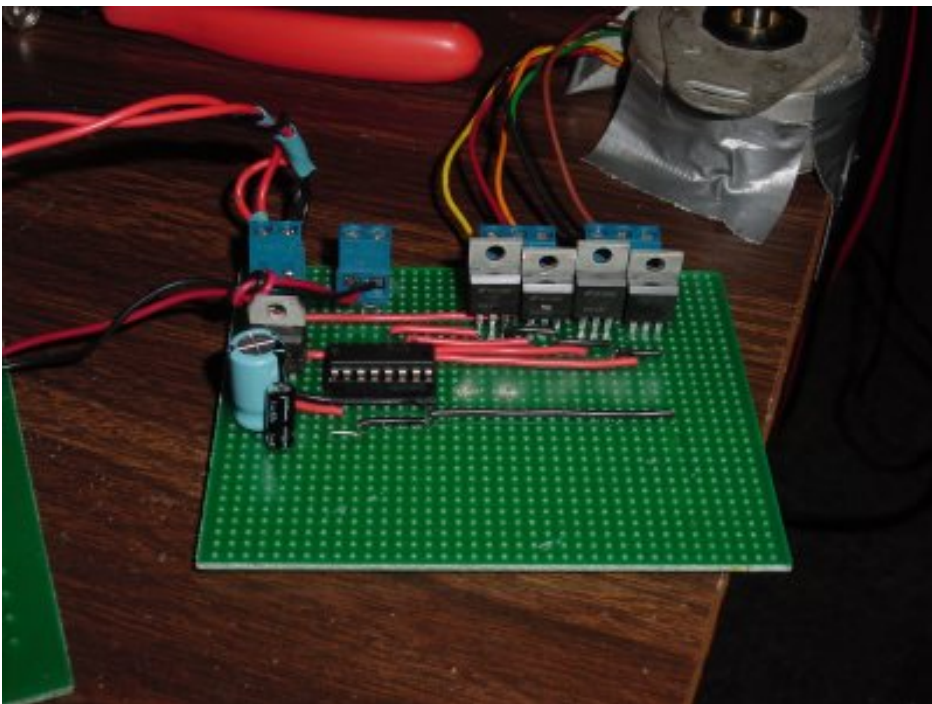

Here you can see me milling the gear pair. It took me about 40 minutes to do the job and would

have gone a bit faster if I hadn't been fooling around. The gears have big teeth, which means that they could be printed on a Darwin by somebody MUCH less able than Nophead.

I'm tooling up to design a gear train that employs a cheap GM-17 gearmotor to run a pinch extruder using the latest Bowyer configuration. The point is that three pairs of gears for axes and a gear train set for a pinch extruder is all that anybody would need to make a next-generation Reprap machine anywhere assuming that they could get salvage or new tin can steppers wherever they happened to be.

The point is that the controller board kit that I use plus these simple set of parts which I could knock out in an afternoon can be put in a padded envelope and shipped anywhere in the world for maybe \$10. The other bits could be acquired locally.

Now THAT's replication that will get Reprap everywhere.

Powering the tin can stepper lead screw

Saturday, 7th March 2009 by Forrest Higgs

In which your narrator knocks off a unipolar driver board using I2C comms with the MCU in a very few hours...

I put this little board together to explore the possibility that one could effectively drive cheap unipolar stepper motors via an I2C link with the MCU rather than tapping a bunch of I/O pins. I put it together by slaving four HUFA76419P3 Mosfets with a Texas Instruments PCF8574 chip slaved to a Microchip 18F4550 via a software driven I2C bus. The electronics are trivial and appear to be very reliable.

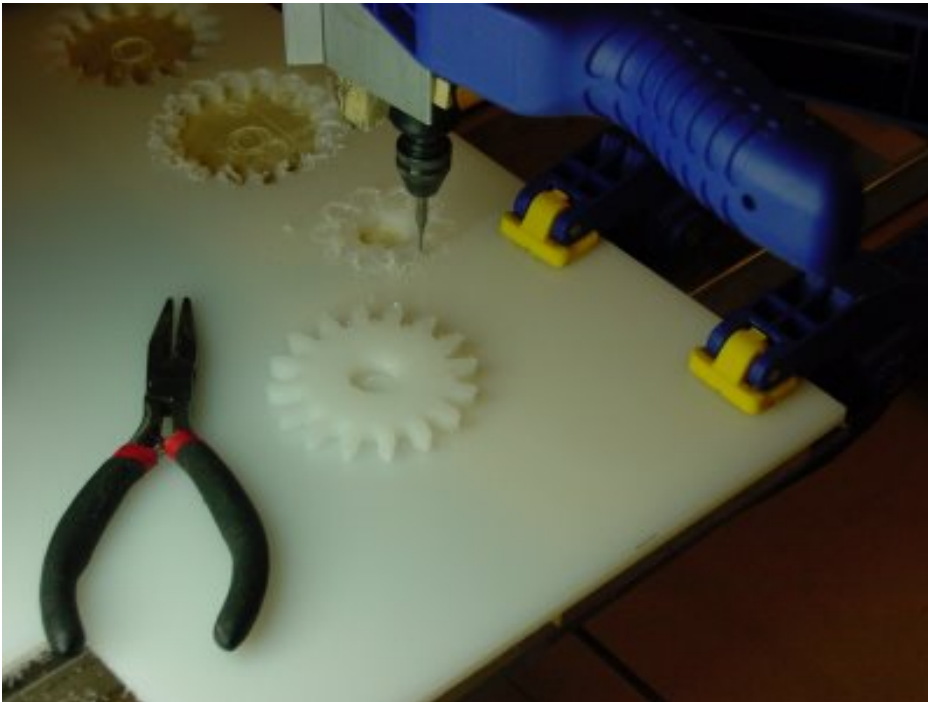

The board was trivial to make. The screw terminal and capacitors on the left side take in 12v and ground and turn part of it into 5v to power the Texas Instruments PCF8574 chip. The other 2 pole screw terminal just to the right of the power input screw terminal handles the SDA and SCL lines from the MCU's I2C bus and connect directly to the PCF8574 chip.

The last four bits of the byte transmitted to the board over the I2C bus are used to trigger the four Fairchild HUFA76419P3 Mosfets which charge the four phases of the Airpax unipolar stepper motor that you can see at the upper right of the. The four orange leads from the far side of the PCF8574 make those connections.

I used the HUFA76419P3 Mosfets mostly because I had them lying around from a project to build a bipolar driver board that I never got around to doing. They are monsters and can handle up to 27 amps continuously. They only cost a bit over \$1 each from Mouser, though. I'd never contemplate putting anything near that kind of load on this prototype board, mind. It would vapourise the stripboard tracks, for one thing even though the Mosfets could handle it.

I've got the Airpax unipolar stepper cranking, but there is a bit more work to be done getting it into high torque mode.

To save comments on this point, understand that unipolar steppers are 30% less powerful than an equivalent bipolar stepper with the same weight of wire in it. The electronics, on the other hand, are trivial compared to what you have to do to run a bipolar stepper and can easily be built from discrete components.

This board will be driving my tin can {permanent magnet} stepper driven lead screw axis which I hope to use for Tommelise 3.0.

Late update: I found an old Airpax catalog and got the proper lead colour codes and stepping sequence. Putting that into the firmware I was able to test the limits of the big Airpax stepper motor. The one I have is the equivalent of the catalog's 57M024B2U.

The terminal velocity that I could get from a standing start was 228 pps which matched the pull-in torque line from the catalog very closely. When I used a half-speed startup for 24 steps I was able to push that reliably up to 311 pps. The best I could do with that startup regimen was 444 pps. There was virtually no available torque at that rate and precious little at 311. I suspect that we might be able to hit 250 pps and run the gear pair on the tin can stepper to power a lead screw.

What that means is that with the gear pair that I designed {1.6:1} I should be getting about 0.105 mm/pulse or a peak single axis velocity of about 26 mm/sec.

The nice part about this scheme is that I can change the resolution of the system simply by changing the gear pair.

Later update: Here is the basic board layout taken from my PCB milling software. The components aren't labeled, but from the picture they're not hard to figure out.

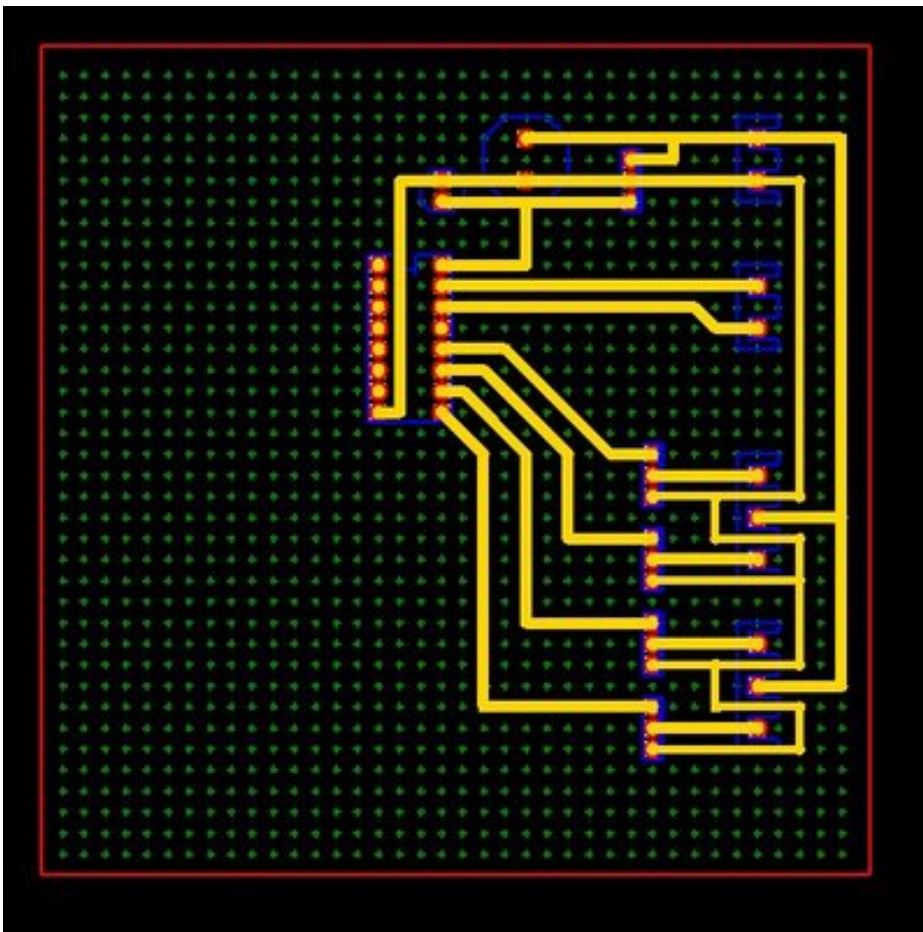

A small milestone

Monday, 9th March 2009 by Forrest Higgs

In which your narrator cuts a power transmission gear out of 3/8" inch HDPE, the thickest milling job yet...

Nophead went over my I2C controller board layout and showed me how to deal with back-EMF with diodes and a zener diode this afternoon, so that I know now what to do with that. His electronics advice is priceless.

This evening I did several trial milling jobs to get the diameter right for the stepper gear for the tin can stepper axis for Tommelise 3.0 and, possibly, eD's new wedge Darwin 2.0. I wanted the gear to have a tight, compression fit with that weird half inch shaft sleeve on the old Airpax stepper. After two tries I got that right and then set out to see if I could cut the gear out of heavy, 3/8" HDPE. I wanted the stepper gear thick so that the lead screw gear, which I will cut tomorrow out of 1/4" HDPE won't have to be in perfect alignment with it.

In any case, it took me about an hour and a half to cut the gear. It came out looking pretty good.

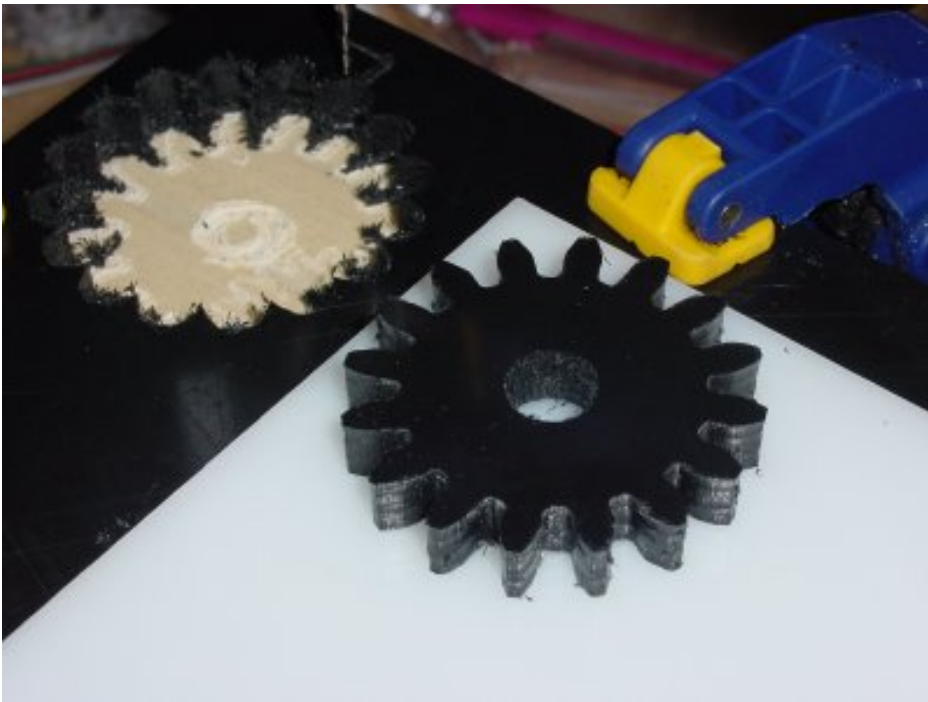

Here you see me using an ordinary C-clamp to press-fit the gear onto the stepper shaft sleeve.



The nice thing about compression fitting is that you don't need set screws or glue or anything of the sort. You just put the gear on the shaft under compression and it's on to stay. I'd have to cut that wood mounting block apart to get the stepper out of there. That or cut the gear apart.

Abandoning the conventional approach

Monday, 9th March 2009 by Forrest Higgs

In which your narrator discovers that the convention way of running a lead screw drive isn't going to work properly...

I cut the lead screw gear before starting work this morning and knocked the drive together at lunch. It runs fine.



The problem is that it appears to me that you don't have enough torque to push the drive much beyond 12.5 mm/sec with anything like a useful load.

At that point I did a few calculations. My back-of-the-envelope calculations indicated that the kinetic energy in the spinning lead screws at 9×10^{-3} Joules was more or less the same amount of energy as it took to move a 2 kg positioning table, that is, about 14×10^{-3} Joules.

Now if I turn the thrust nut instead of the lead screw and move either the nut and the stepper motor assembly or the lead screw, both weighing about half a pound each, I only require about 1×10^{-3} Joules instead of 9.

If I have time tomorrow, I will recut the lead screw to seat a thrust nut and see if I can't get more

speed and torque out of the drive.

Kitty Warning!

Wednesday, 11th March 2009 by Vik Olliver



When testing stepper motors out by sticking some paper tape to the axle and firing up a test program, do not allow kittens on the bench. My rescue-kitty "Mitre" saw the little flag going round and round - and ate it.

Oh, he used my keyboard as a springboard en route. He's not one to pass up an opportunity. His next exploit appears to be to put PLA in his litter tray via his digestive tract. I know it is bio-compatible, but that's not the point.

I think its time kitty left the workshop.

No Mitre! Not the keyboard cab

Direct drive turns out to be the best

Saturday, 14th March 2009 by Forrest Higgs

In which your narrator finds that simplest is best...

After extensive tests I had decided that I had to freeze the lead screw and turn the thrust collar nut to get enough torque out of the tin can stepper to make a practical difference. Indeed, that might have worked but there was a simpler way.

Going from a 3/8-16 lead screw to a 1/4-20 dropped the inertia of the lead screw by 80%.



A bit of sticky tape on the end of the 1/4-20 lead screw gave me a very firm connection with the surplus Airpax stepper and enabled me to run meaningful thrust exercises with it.

I discovered that it was possible to get 250 pps out of the stepper in this configuration. Further, at that rotational rate I was getting 4-5 lbs of thrust, considerably more than the Haydon linear steppers are giving me now on Tommelise 2.0.

That translates into a touch over 13 mm/sec axis speed.

I'm done fooling with this. T3 is going to use a direct drive powered by old Airpax tin can steppers. \$150 in parts, here I come. :-D

Drink Bottle Feedstock

Sunday, 15th March 2009 by Adrian Bowyer



Over on the Builder's Blog Paul Midgley had the brilliant idea of cutting polyethylene terephthalate (PET) drink bottles into helical strips and using them as a RepRap extruder feedstock. I thought of folding the strip in half to make it stiffer (and hence easier to push into the melt zone).

So. Time for an experiment. I took my old screw-drive extruder (now replaced by the rapidly coming-together pinch-wheel design), clamped it to the bench, cut a very crude strip of PET from a drink bottle about 6mm wide, folded it in half, and pushed it into the nozzle by hand.

It extruded well at about 230 °C. It behaved in very similar way to polylactic acid, though that will extrude at about 180 °C.

Cutting the strip in production should be fairly straightforward using a blade held 6mm from a barrier, and simply pulling on the forming strip. The pull could even come from the extruder. The pinch-wheel design could both generate the pull, and - with a small redesign of the polymer channel - automatically start the fold, which would then be completed by the pinch wheel.

When it was cooling, I pulled it back out to see what had happened:

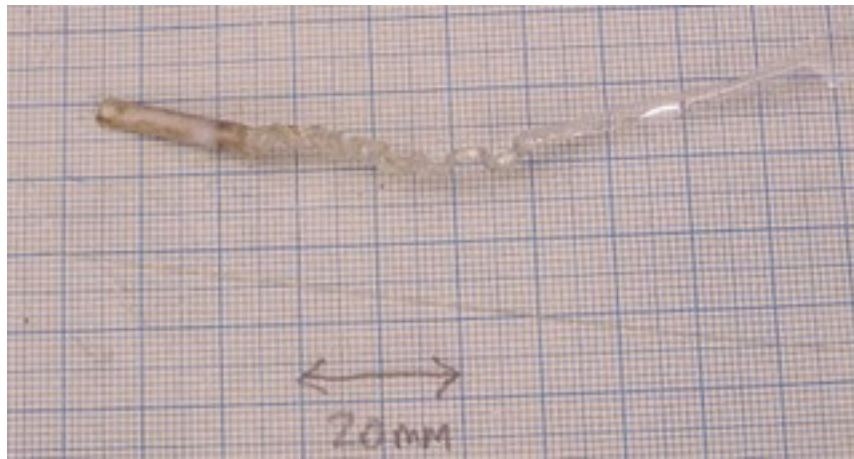

As you would expect, the strip had concertinaed in the wider nozzle channel (top of this picture). This didn't stop the device working at all, but in a real extruder it would lead to a lack of controllability because of the springiness of the zig-zag. This would be easy to fix simply by designing the channel to be the thickness of the folded strip.

The PET at the tip set cloudy, when the original was clear. I suspect that this means that it's become semi-crystalline as opposed to amorphous (see the [PET Wikipedia entry](#)). What this means for objects built from PET remains to be seen.

The filament created is at the bottom of this picture, incidentally.

Announcing MakerBot Industries

Monday, 16th March 2009 by Zach Smith

MakerBot INDUSTRIES™

If you've been wondering why I've been so quiet lately, then wonder no more! For the past couple of months, I've been working on getting a RepRap based company off the ground with the help of my friends Bre Pettis and Adam Mayer. The name of the company is MakerBot Industries and we make robots that make things.

Our first major project is a RepStrap design called CupCake CNC. We set out to create a simple, low-cost 3D printer that is easy to assemble, and capable of printing the vast majority of things that one would print with a RepRap machine. We've also made it essentially 100% compatible with the rewrap design, and it is controlled by the RepRap electronics and software.

The idea behind CupCake CNC and MakerBot in general is that we love 3D printing, and digital fabrication in general. Our dream is for everyone in the world to have cheap, easy access to these cool technologies. For us, that means that we should provide them as cheaply as possible, and make them as easy to use as possible. For now, the easiest way for us to do that is to build RepStrap machines with our laser cutter. We're hoping that as the RepRap technology matures, we will be able to use that to produce our machines and lower the cost even more. As a core developer of the RepRap project for 4 years now, I'm a firm believer that is what is going to happen.

The CupCake CNC idea was mainly Bre's. His original idea was to build a cupcake frosting machine, and we have a prototype frosting extruder aka Frostruder that does exactly that. However, we also realized that the vast majority of RepRap parts, and indeed the vast majority of parts that one can reasonably print on a RepRap machine are about the size of a cupcake. Thus, Cupcake CNC was born. We borrowed some of the best ideas from a few of the other open source 3D printer designs: a lasercut box from Fab@Home, electronics, software, and extruder designs from RepRap and combined them into something that is uniquely ours.

The result is a nice, tidy machine with very few external parts that prints very nicely. The setup is actually inverted from a standard RepRap machine. On ours, it is the build platform that moves in the X/Y plane, and the extruder is stationary on the Z platform which raises it up and down. Since the various extruders tend to be a bit heavier than the things it is building, we opted to switch it up a bit. The X/Y platform is belt-driven and uses cheaper, smaller NEMA 17 motors. We use pulleys from SDP-SI which give it a resolution of 0.085mm/step. When the new, smaller pulleys arrive,

we'll improve that resolution to 0.075mm/step. The Z-axis uses standard M8 threaded rod which gives insanely high accuracy. We've also used standard 608 skate bearings throughout the design to give it a butter-smooth operation. It has a build area of approximately 100mm x 100mm x 100mm (~4 inches on a side).

Anyway, we're excited to expand the number of options available for cheap 3D printing and look forward to releasing many new and exciting developments in the coming weeks, months, and years. We have a few super-rad surprises that we'll be unveiling in the next couple of weeks, so stay tuned.

Obviously, the vast majority of things we do will be totally open source. We firmly believe and trust in the open source hardware movement and look forward to building an awesome future together.

If you want to keep an eye on us, you can check out our [website](#), subscribe to our [blog](#), follow us on [Twitter](#), join the [Facebook group](#), hack on our [wiki](#), check out our [subversion repository](#), or browse through our [online store](#).

Of course, if you'd like to [pre-order a CupCake CNC](#), its \$750 for *everything* you need to build and start printing. We'll be putting the finishing touches on the design and thoroughly documenting the machine in the next weeks, and pre-orders will ship on or before April 15th.

Oh, and here's a little video we made:

[Makerbot Industries - Cupcake CNC](#) from [MakerBot Industries](#) on [Vimeo](#).

Wedgewood Update - Z Axis Begins

Tuesday, 17th March 2009 by Vik Olliver

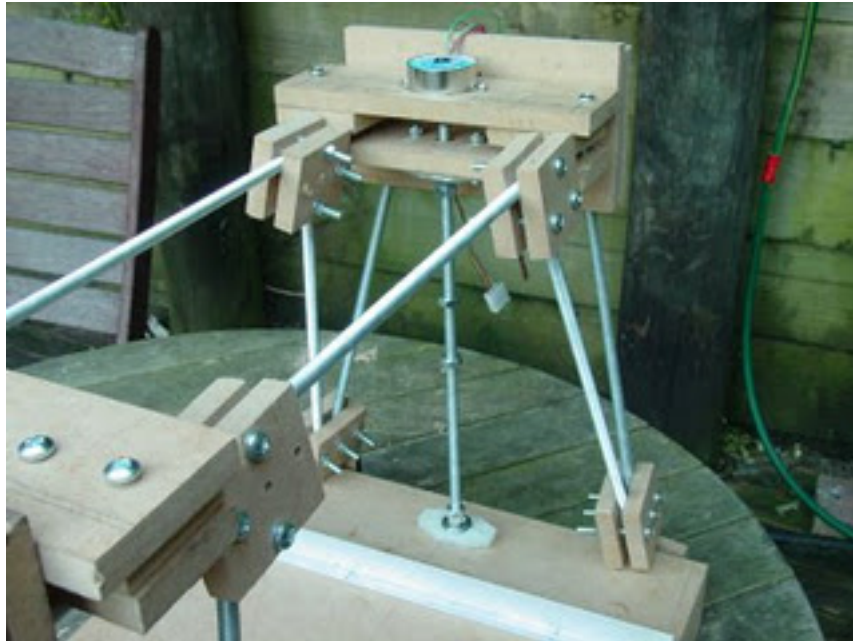

I've been away for much of the weekend, and crook yesterday so I've not had much time to work on RepRap. Next weekend is a 2 day chainsaw course, so I'm working on Wedgewood whenever I can. Here you can see the beginnings of the Z axis mounting scheme, using the PLA bearing holders I printed earlier to anchor the Z axis studding (one on the top that's hidden from view, and one on the bottom). I've removed the deposition bed so you can see the bearing holder.

The two nuts in the middle of the studding will be held captive by the X axis mountings. Given the weight of the head and X axis, it is unlikely that I'll need any anti-backlashing but it can be done if need be.

For the moment I'll use 2 tin can stepper motors to drive the Z axis, which neatly eliminates the need for a chain or driveshaft to link the two halves and gives me more torque where it is needed most. I've only got 2 of the Jaycar YM2751 steppers as the depot ran out of stock, so we'll see if they get stock before I can finish the Z axis.

The object of the exercise? To see if the Z axis on a Wedge design is going to need guide rails or not.

Vik :v)

Thermoplast Extruder Version 2.0 Released

Saturday, 21st March 2009 by Adrian Bowyer

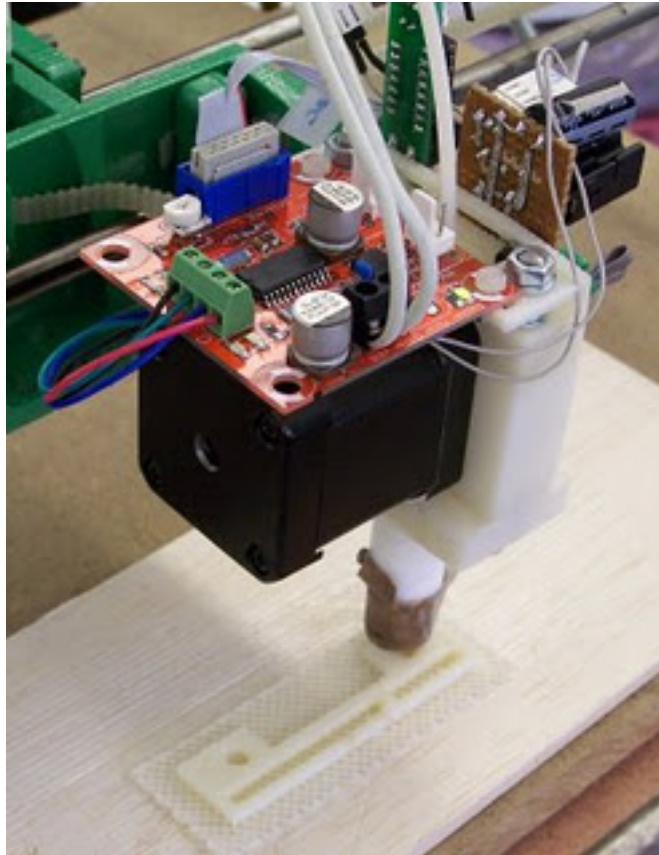

The Thermoplast Extruder Version 2.0 - the new pinch-wheel design - has been released. It has these advantages:

- It can be driven faster than the older screw-driven extruder
- It has fewer parts (both rebrapped and added from outside)
- It is easier to make
- It can be controlled more precisely and simply
- It can be reloaded while it is working without interrupting a build
- It should be more reliable (only time will tell...)

I've been running it for a couple of weeks now, and it goes very sweetly, particularly with ABS (shown above). *And it's really superb with polylactic acid.* On my home Darwin I build with that at carriage speeds of 3000 mm per minute, which is *fast*, and - of course, unlike ABS - it doesn't distort as it cools. This means perfect parts quick - what's not to like?

RRRF Prototyping Service Launched!

Monday, 23rd March 2009 by Zach Smith

As part of the current RRRF transformation, I'm happy to officially announce what has been long-standing RRRF tradition. We are now opening up our prototyping services to the community and spelling out exactly what things we can do (PCB fab, lasercutting, 3D printing, etc) and how you can go about using us to help you make RepRap better.

Anyway, you can read all about it over on the RRRF info page. Essentially, we're can help RepRap developers improve the RepRap project by covering the costs and doing the gruntwork on getting PCBs made, prototypes lasercut, parts machined, etc, etc. We hope that providing this service to the community will help spur more rapid development of the various technologies associated with RepRap.

Cheers,

Zach Hoeken

Director, RRRF

Wire nozzle

Monday, 23rd March 2009 by eD

Since Zach's idea of using a stepper shaft to drive the extruder, the design's got a lot simpler. We're now at a point where we've only got one non-standard mechanical component in the whole design which needs custom, precision machining: the nozzle.

I had an idea which might get round that: is the Nichrome wire (the heating element) flexible enough to form the nozzle itself? By wrapping the wire around a former, then setting it in an insulating material the wire creates the working profile for the nozzle:

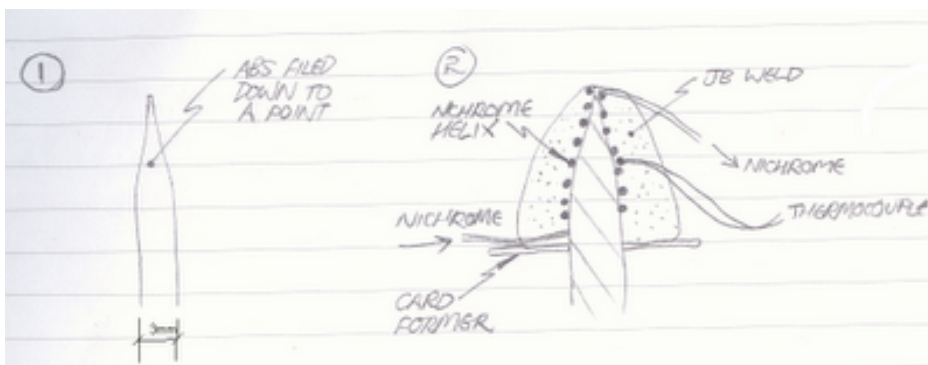

Here JB Weld acts as the insulator. This approach requires no lathe as the former can be made out of ABS filament. The former can be removed by simply turning on the power (ABS melts at 105°C, JB weld decomposes at 200°C) and pulling it out when molten.

Potential advantages for this design:

- € No machining needed.
- € Direct heating from the element to the polymer (no thermal inertia in the nozzle design).
- € Compact.
- € One less part.
- € Opportunity to alter the draft angles to optimise fluid flow.

The completed nozzle was set in a PEEK cylinder with more JB weld.

Results:



Problems:

€ Extrudate was quite fat (~1mm) due to orifice size. This was the first one off though, so will experiment with a former which incorporates a needle to get a tighter wrap at the tip.

€ JB Weld decomposes at 200°C which doesn't leave much of a margin. Will experiment with fire cement instead.

€ Wire coming from top of helix is close to the orifice. Will experiment with double helix element so that the wire enters and exits at the 3mm end of the nozzle.

€ Potential for non-insulated Nichrome to short circuit if helix is not accurately wound. Will experiment with insulated Nichrome (though fluffy glass insulator is not ideal as a fluid surface and is likely to wear quickly). Note: with a bit of programming, the Cartesian bot might be able to help with the winding.

Wedgewood Update - Z axis in place, X begins

Sunday, 29th March 2009 by Vik Olliver



Here's Wedgewood with the Z axis components (minus the actual coupling for the X axis) in place and supporting the aluminium T-section that will serve as the X axis slide. Tests conducted by twiddling the vertical shafts by hand suggest that there is no need for guide rails on the Z axis, so that simplifies construction a bit.

Also, note that I've trapped the nuts for the Z axis between slabs of MDF. Another quick construction technique.

So far, all of the bits can either be rebrapped or made from MDF and epoxy or CAPA.

Vik :v)

more WeDge

Wednesday, 1st April 2009 by eD

Hi! It's been a bit mad getting all the admin out of the way this end, but finally I get to post what I've been tinkering with recently: my take on the Wedge design exercise (from a previous post, [here](#)).

Vik's been testing out the concept in the real world and it looks like things might check out! Meanwhile I've been working on incorporating self-manufactured parts into my take on the concept, below (if you want a virtual fly through of the design, check out the notes at the end of this post).



Design notes:

- This is a first cut only! Still some elements to be included. Also some things are just in here out of convenience. For example, round bars are used as bearing surfaces because I have them in stock. Will move over to Vik's idea (angle iron is more ubiquitous) when fully proven.
- Uses NEMA 17s
- Top studding will be used as tool-change gantry.
- Footprint is 500 mm x 500 mm

- Working area is currently roughly 250 mm x 200 mm, this will be optimised of course

Virtual Reality viewing notes:

I can recommend using the Cosmo Player VRML plugin with the Firefox browser (though if that doesn't work out, try here)

Once you're set, simply open this file.

Ed Sells

Wednesday, 1st April 2009 by Adrian Bowyer



Well done to Ed, who's just passed his PhD viva voce. He has to make a couple of minor alterations to his thesis, and then he'll have his PhD. So, from the Bath University graduation ceremony this summer, he'll be Dr Ed...

Reprappers (and anyone else...) who wish to add their congrats can do so via:

skinnyed at gmail dot com

Now Available: Stepper Motor Driver v2.3

Thursday, 2nd April 2009 by Zach Smith

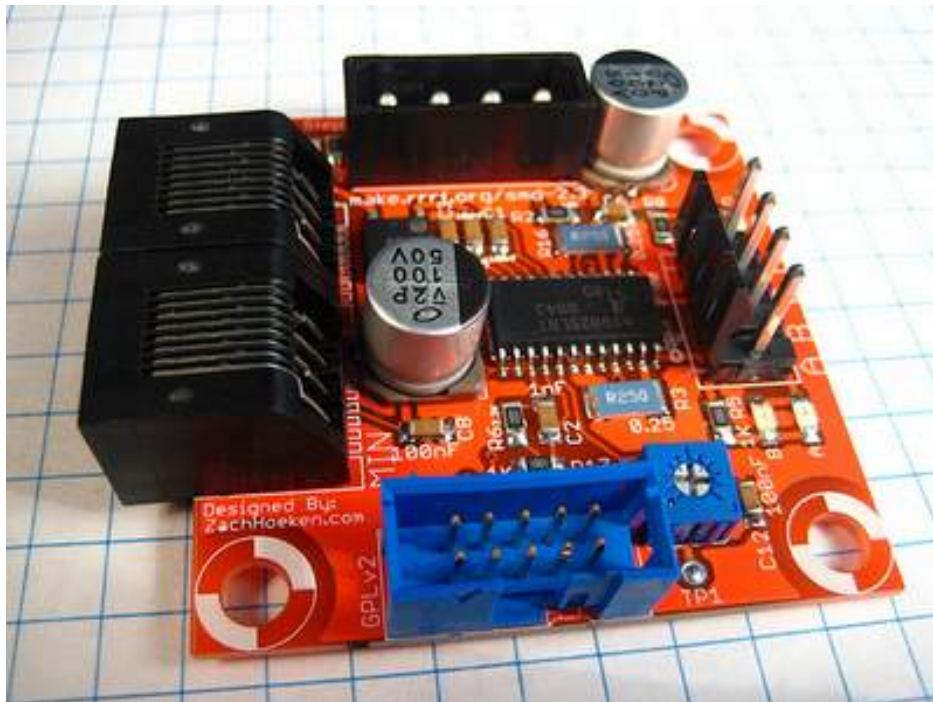

This new board has been in development by the RRRF for quite a while as we've been trying to get it just right. The v2.3 design has homed in on the excellent A3982 stepper motor driver chip from Allegro. This chip is cheap, reliable, and excellent. This new board actually drops the price of EACH stepper driver by about \$10 and makes it easier to build. Its surface mount, but using the hot-plate soldering method, you get a much nicer board and I've actually found it to be much easier than soldering up a million through hole components.

This board has the same pinouts as the previous Stepper Motor Driver v1.2 board, so will be a very simple upgrade if you're so inclined. The pinouts for the stepper connector, opto endstops, IDC connector, and power connector are all the same. Yay for standard interfaces!

Thanks to Lou Amadio, and the RepRap team for help in refining this board.

Anyway, you can get kits and pcbs from MakerBot Industries. We'll have fully assembled boards in a few months as well if you're too stubborn to learn SMD soldering and DIY.

Oh, and if the new hotness of the board isn't enough, check out this video of the new stepper tester code I wrote to go along with it. Tell me that doesn't make you smile and I'll frost you a cupcake.

Test Pattern 8 from MakerBot Industries on Vimeo.

A gripping read

Sunday, 5th April 2009 by nophead

I have done some work comparing the amount of grip that different extruder drive methods achieve. I measured the amount of force the following devices gave before the filament slipped: -

A 4mm splined shaft.





A 13mm timing pulley

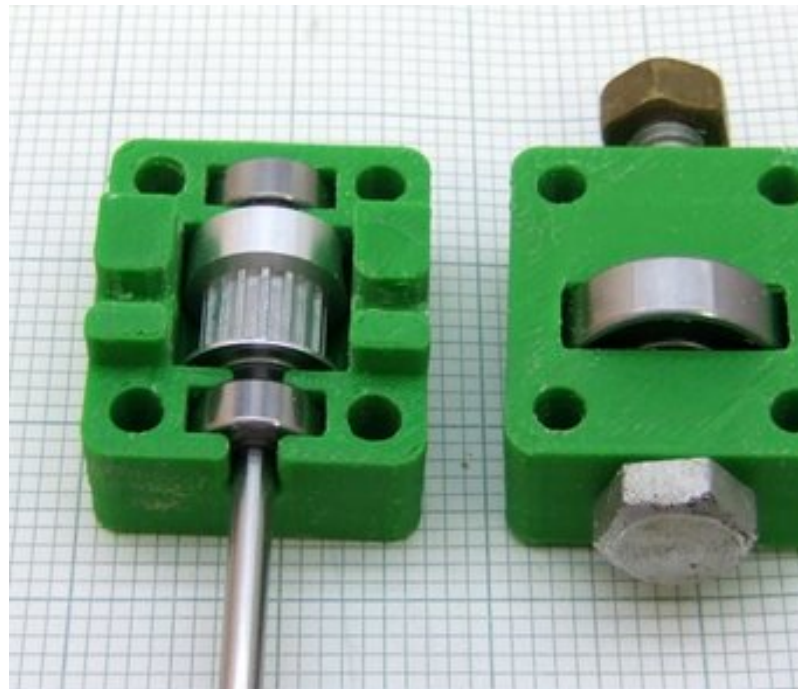

The original M5 thread drive



A 13mm knurled wheel

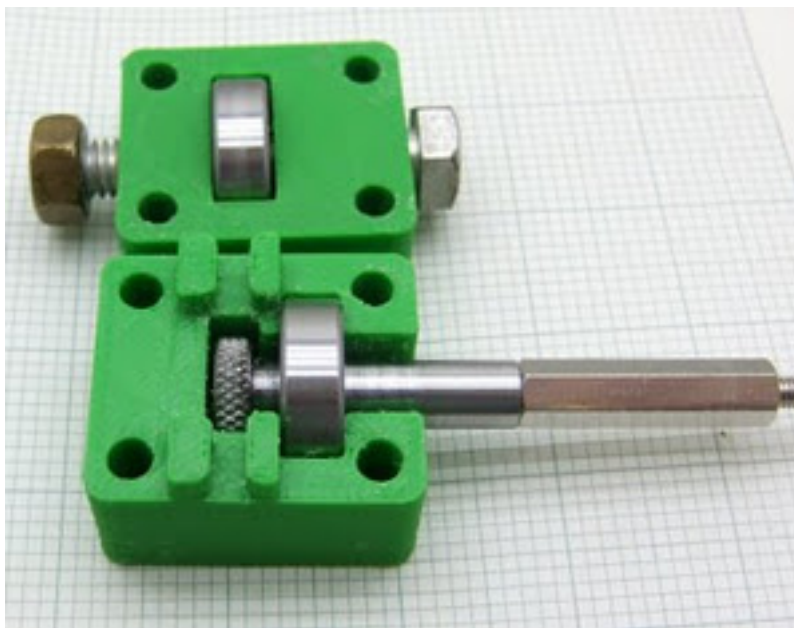



A 13mm threaded "worm" pulley



The results where as follows: -

	PCL	HDPE	ABS	PLA
4mm splined shaft	2.5 Kg	3.0 Kg	5.0 Kg	7.5 Kg

13mm timing pulley	4.0 Kg	10.0 Kg	8.5 Kg	>8 Kg
13mm knurled wheel	5.0 Kg	10.0 Kg	12.0 Kg	>12.5 Kg
13mm M4 worm pulley	6.0 Kg	>12.5 Kg	>12.5 Kg	>12.5 Kg
13mm M3 worm pulley	8.0 Kg	>12.5 Kg	>12.5 Kg	>12.5 Kg
M5 thread	9.0 Kg	>12.5 Kg	>12.5 Kg	>12.5 Kg

The red figures are lower or marginal compared to the force required to extrude 0.5mm filament at 16mm/s.

More details in my blog hydraraptor.blogspot.com/2009/03/pulling-power and hydraraptor.blogspot.com/2009/04/all-torque-and-no-traction.

RepRap hits Parliament

Thursday, 9th April 2009 by eD

A few weeks ago it was the final round of the "Science Engineering and Technology for Britain" awards. I was there waving the RepRap flag, and it just so happened to be held in the British houses of parliament! I got to tell a lot of MPs about our work and reactions were as brilliant as usual. Here's my poster...



The self-replicating 3D printer:
enabling manufacture in your living room
by Ed Sells, 9th March 2009, ed@sellsbath.ac.uk

AIM
The aim of this research is to enable the manufacture of consumer goods in the home. 3D printing is a new technology which is already common in many homes, but the technology is currently too expensive. The RepRap project has developed an open-source 3D printer with the ability to manufacture its own parts. This allows the printer to self-replicate, a feature which has the potential to significantly reduce the cost of the 3D printer and improve performance to a point where the technology is viable for home use.

Introduction to 3D printing
3D printers build layers of material on top of each other, with precise control, to build up 3D objects (illustrated below). This technology is capable of building highly complex, accurate components in many different materials, typically polymers and alloys. Techniques used to print the layers include laser sintering and filament deposition. Unfortunately the cheapest 3D printer on the market is approximately £20,000.

Designed on a computer... computer splits object into thin layers... 3D printer adds layers to produce the object

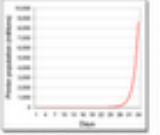
Research and development
For his PhD, the author was challenged to design the mechanical aspects of a self-replicating 3D printer. Development was carried out to produce a machine which could be assembled by hand from off-the-shelf parts or parts which it could make itself. The author employed a number of mechanical techniques to achieve this, specifically he designed for:

- maximum adjustability to meet the needs of the machine's major applications
- addition of edge parts to extend the range of working volume
- compensation for wear/loss in the fit of components
- printing of thin substrates
- absolute accuracy using a highly accurate stepper motor
- manufacture without the use of a traditional material with heat
- a great selection of parts, ease of assembly, simple maintenance

Why should it self-replicate?
Self-replication enables exponential growth, making the technology accessible and reducing its cost. For example, if a 3D printer was capable of manufacturing itself once every day within 24 days, recursive printing, it could produce enough machines for every man, woman and child on the planet! This is illustrated in the graph below, where population = $2^{(days \times 2)}$.

A self-replicating 3D printer will be subject to laws of evolution established by Charles Darwin (below). This project is open source and encourages design ideas from users should they wish to adjust a modification. Therefore each new 3D printer can benefit from accelerated artificial selection.

RESULTS
In May 2008 the prototype 3D printer (below) demonstrated self-replication by printing a copy of itself. Self-manufacture took between 48hrs and the material cost was £200. It took 48hrs cheaper than the cheapest commercial machine. The self-manufactured part cost was 60%, with the balance of the part made by the user (electronics and fasteners) it is expected that the cost will drop to half within two years. Other achievements include:

- Over 1000 machines in operation across the world
- Full open source release through the internet
- An excellent research foundation committee to supporting research and development towards the project
- Two well-run businesses selling kits of the design from the UK and USA.

Implications for society
Masses of self-replicating 3D printing technology to be accessible for education and research centres.
Mid term: enables a local means of production for consumer items, offering an alternative to our current centralised mass-manufacturing structure which relies heavily on an extensive distribution network. Local manufacture is better for the environment and enables faster customisation.
Long term: self-replication is an important technology for the exploration of outer space.

References and further reading

- project website: www.reprap.org
- cost of a Stratasys Dimension HP printer
- world population from US Census Bureau
- "Ultimate Self-Replicating Machine" by Freitas, R.A. and R.C. Weisbe (2004), Texas: Landes Bioscience

BATH
RepRap

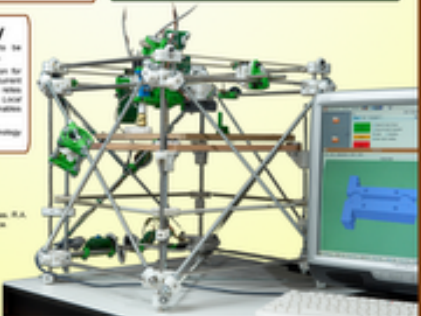

and here's a really terrible shot of me after too long at the free bar, with an MP from north Wales.



I didn't win (obviously... did I say there was a free bar?) but it was very interesting to delve so physically into the political structure of my country. (What I saw restored a lot of my faith in our society... it may not be perfect sometimes, sometimes a long way off, but people are genuinely trying spectacularly hard to make it better €“ that alone seems to me to be a wonderful thing about being a human).

Cheap linear bearing hack

Thursday, 9th April 2009 by eD

I don't know if this is useful to anyone, but I recently tried using the inner diameter of a skate bearing as a linear bearing on an 8mm (or 5/16") ground bar. It slid up and down really well - good enough to be used as a bearing in a mechanical design. I'm not sure if this scales yet (i.e. will a 625 bearing work on a 5mm bar too?) and performance might not be *quite* as slick as a proper bush/recirculating linear bearing, but man it's such a cheap hack!

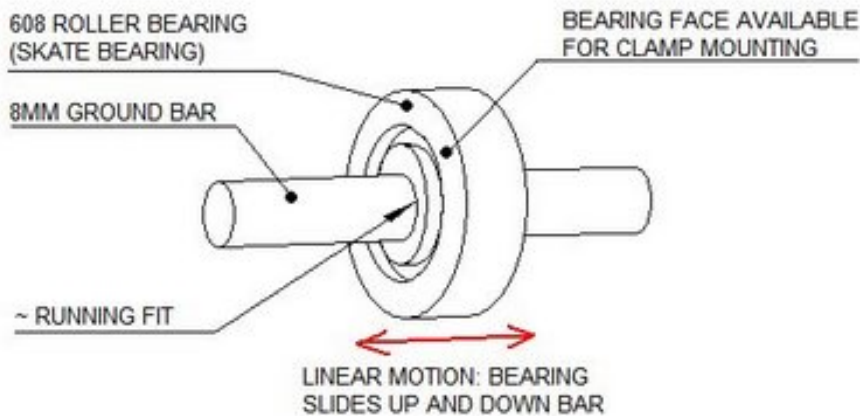

From the self-manufacturing point of view, having recently (personally) accepted the ball-bearing as a vitamin part I'm finding this capability to be awesome.

By your powers combined, I am KAPTON PLANET

Saturday, 11th April 2009 by Zach Smith



Image not found.

Some say that necessity is the mother of all invention, and I'd have to agree with them. When we decided to start MakerBot and launch a complete 3D printer kit for under a grand I knew we had a lot of work cut out for us. Transitioning the RepRap technology from a research project to something that is a product presents many challenges. One of my main tasks was preparing the Plastruder MK3 for production.

I had been developing the 3rd generation extruder as part of RepRap for a while and it worked great. However, there were parts of the process that just weren't suited for a DIY kit at all. The main problem was attaching the nichrome wire and thermistor to the heater barrel so you can accurately control the temperature. For years (literally) we've been attaching the nichrome wire to the heater barrel with some form of high temperature cement: first JBweld, then with fire cement and stove cement. The latest revisions for doing this all work, but I didn't like them.

Why? Because they are horribly messy. Stove cement is an awful, black compound that stains and is probably toxic as hell. Fire cement only comes in 55lb bags. Stove cement only comes in giant 5 oz tubes. All you need is a tiny amount of this stuff to insulate and bond the nichrome. Plus, it is a very delicate process to wrap the nichrome and then apply the goop the whole time hoping that you don't jiggle it the wrong way and have everything fall apart. If some of it gets in your extruder nozzle? Game over. Oh, did I mention that you have to let it sit OVERNIGHT to fully cure? You're all fired up to build your extruder and WHAM! Instant timeout.



So, what did I do? Well, aside from the initial panic, I decided to try about 10 different techniques and go with the best one. I tried all the various forms and techniques for dealing with high temperature cement when I stumbled upon [this blog entry by Limor Fried of Adafruit fame](#). Something there sparked my eye: it was here use of the Kapton tape. Up until now I had not even heard of it, and maybe it's the same for you as well.

After doing a [few hours of research](#) on it and realizing it was PERFECT for what I wanted, I quickly ordered a tiny little roll from McMaster for \$4. As soon as I got it, I built a heater barrel assembly from it. It took me 15 minutes and I was able to use it right away. It was the fastest and easiest extruder build I had ever done. Usually when I built extruder barrels, I had to use some sort of tape to hold down the leads while I build it anyway. With Kapton tape, I didn't have to remove them and they simply became an integral part of the extruder itself.

Wow, that turned out to be longer than I thought. I managed to find a good supplier of Kapton tape [so you can get it from the MakerBot store](#), and it will be a part of our upcoming [Plastruder MK3 Kit](#) which will start shipping Monday.

Getting a handle on milling accuracy

Sunday, 12th April 2009 by Forrest Higgs

In which your narrator gets a handle on the everyday accuracy of the total tool chain from Art of Illusion to the milled product...

I've been milling HDPE regularly with Tommelise 2.0. Usually, I am designing parts to fit something made out of metal like a bolt, or a NEMA 17 mounting plate. In my more recent project, however, I have been designing parts that actually have to fit other milled parts.

Right now I'm on a quixotic quest to design an extruder that uses a threaded nut instead of a threaded bolt or pinch wheel to pump the filament. Milling is more limited than printing because you can't mill something thicker than the active length of your end mill. With my 1.27 mm diameter fish-tailed, two flute end mill I can handle about 10 mm thick material.

What that means as a practical matter is that if I want something thicker, I have to make it out of milled parts thinner than that. That can get tricky.

It's not like this is an unusual problem in Reprap. The laser cut variations on Darwin have the same problem. There are a number of ways that you can access the problem. The way the Ponoko and BitsFromBytes Darwins hand it is to use nuts, bolts and spacers to assemble parts made of relatively thin plastic.

I've done a bit of that and have been dismayed at how much you wind up paying for all of the nuts, bolts, washers, springs and lock washers you wind up paying for to make anything. A few months ago I knocked out a anti-backlash nut for a lead screw drive.

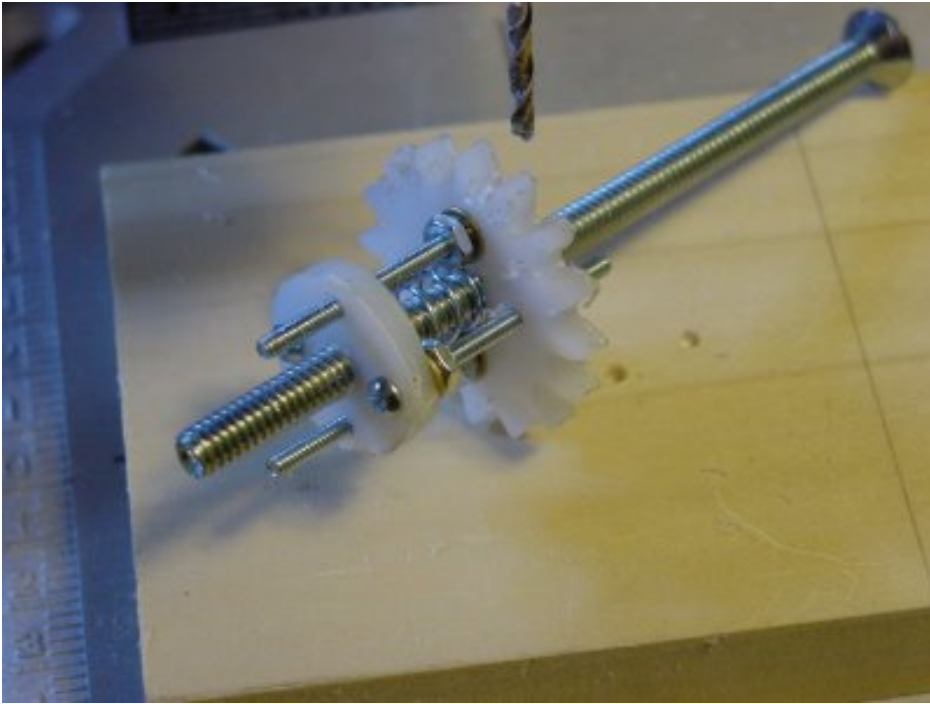

It was a beautiful part, but the bloody hardware to hold the milled bits together wound up costing about ten times what the HDPE parts did. There is something kind of crazy about that.

Since then I've been trying to design things that fit together with a minimum of fasteners. The particular problem that I've been trying to solve in the few minutes I've had away from my day job in the past few weeks has been how to connect the stubby little drive shaft on the Solarbotics GM-17 onto a spur gear to drive the extruder filament pump.



The GM-17 was designed to be bolted onto something like a thin metal plate with a few holes drilled in it. HDPE designed for the same purpose tends to be as thick as the stubby little drive

shaft of this very efficient little gearmotor. what that means is that you have to put a significant extension onto your spur gear and mill a big hole in your mounting plate around the drive shaft so that the extension can reach up through the mounting plate to engage the drive shaft. That's a pain in the neck, to say the least.

The approach I've been taking is to design plugs of 10 mm HDPE that receive the drive shaft and fit into the gear itself. What I have designed looks a bit like this.

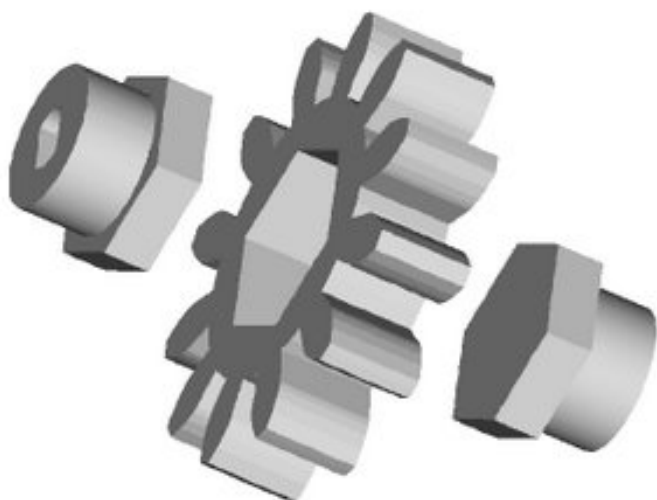

When you do something like that, however, the tightness of the fit between the parts becomes important if you are to avoid a lot of wear. Because of that, I decided to see how close a fit I could get with such a plug using the same hexagonal prism in the open-source Art of Illusion 3D modeling app to make both the plug and the hole that it fits into.

I used the same milling settings for both pieces. Here is what the fit looks like.

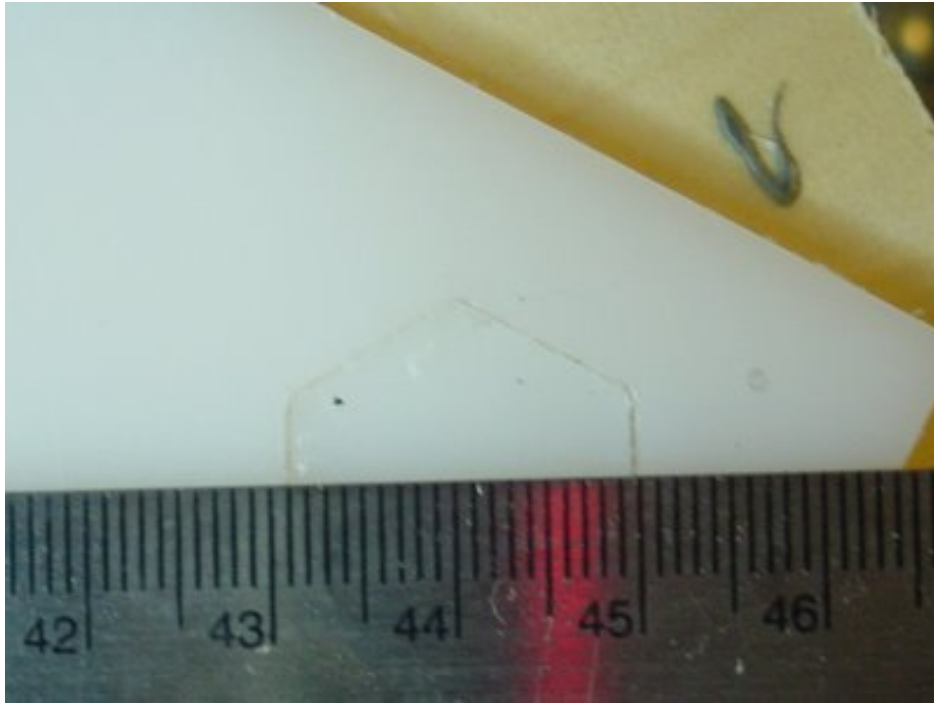

It appears that I get around 0.2-0.3 mm gap between the plug and the hole. Mind, I know I could design tighter fits by upping the nominal size of the plug just a touch. That sort of thing takes a bit of trial and error, though. Now I know how much of a gap that I get when I just go straight for an design solution.

Get your stepper to put splines on its own shaft

Monday, 13th April 2009 by Adrian Bowyer

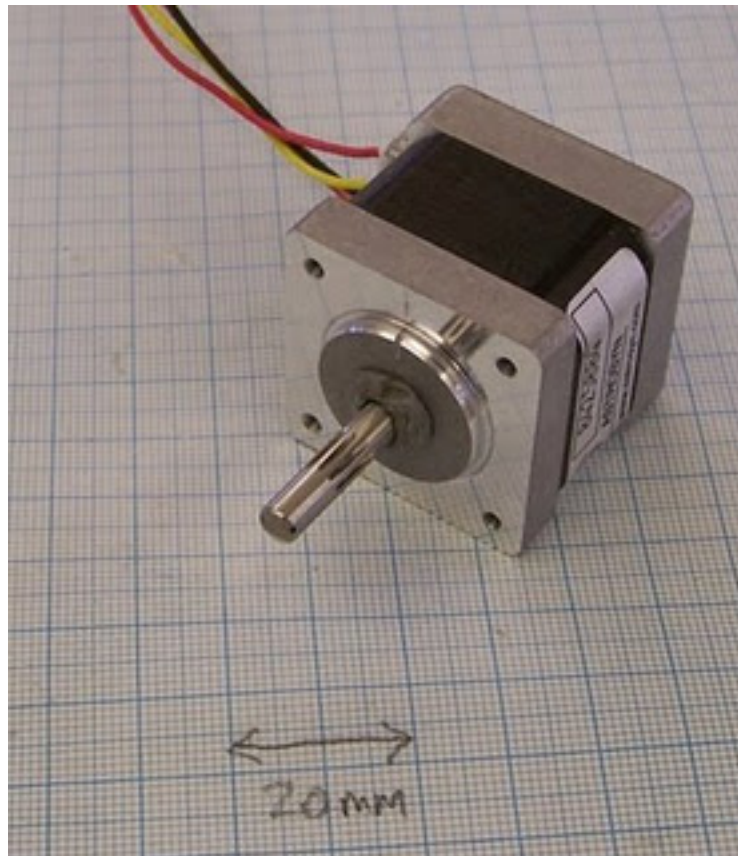

The new pinch-wheel extruder needs to be able to grip the plastic filament that it is extruding to drive it down into the melt chamber. A splined stepper shaft does that nicely, but splined steppers are both rare and expensive.

Here's how to get your stepper to spline its own shaft...

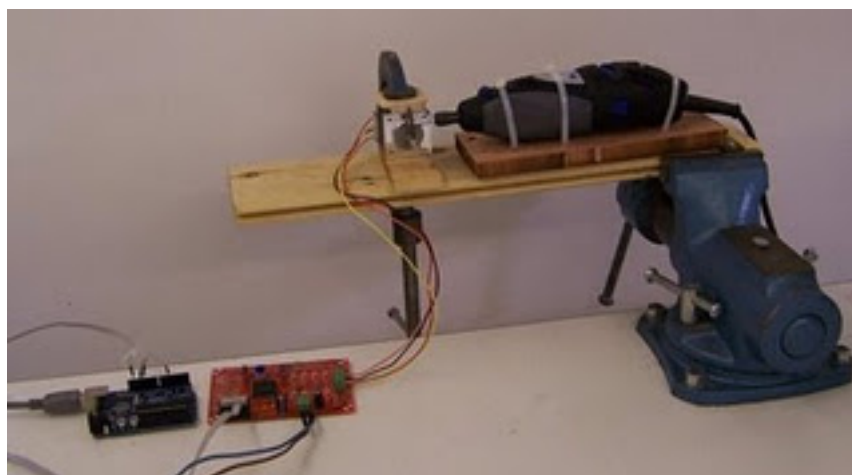

The only special equipment needed is a Dremmel or similar minidrill. The rest is stuff like bits of wood, cable ties, and an old door hinge...

[See here for full instructions.](#) The top picture shows the results.

Bowden extruder concept

Saturday, 18th April 2009 by eD

Anyone who's designed a 3D printer knows that one of the primary constraints is the geometry of the extruder. If the extruder is mobile then it has a big impact on the final volume of the 'bot. I've always been a fan of making the final printer as small as possible (cup cake's footprint's pretty sexy), so to that end I have been looking at options for tiny extruders.

I think the key here is to decouple the nozzle from the drive mechanism €“ it is the motor and its transmission which takes up a big proportion of the extruder's volume. Using some PVC sleeve (3.3mm ID) I decided to follow Forrest's previous attempts at using a bowden cable approach to make a flexible link between the two. The motor is anchored to the side of the bot and drives the 3mm PLA filament (A) through one end of the tube (B) down the flexible tube (C) which terminates in the hot nozzle (D).

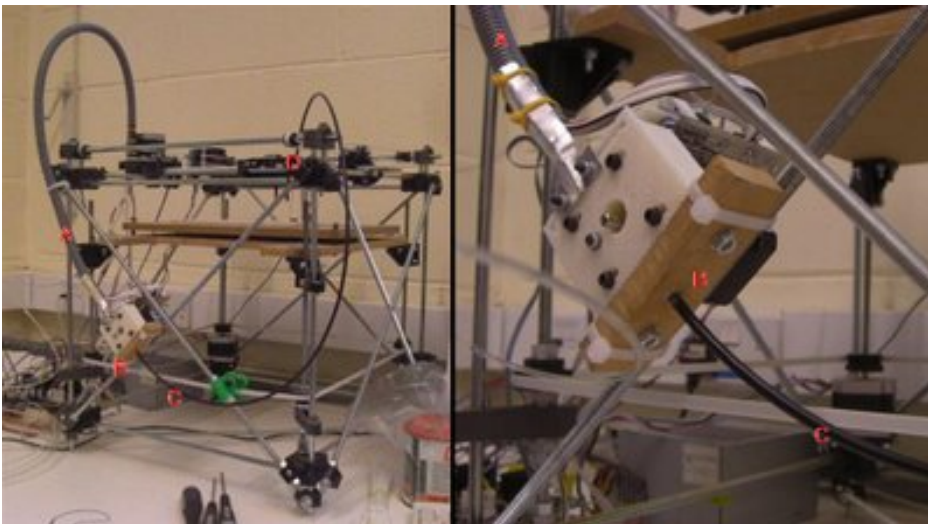

Decoupling massively reduces the necessary volume of carriage which in turn enables a much smaller machine. It also takes a lot of weight out of the moving parts.

Two trade-offs are:

- Increased power will be needed from the extruder motor to overcome the friction in the system (though we're only running our NEMA 17 pinch-wheel extruder motor at 30%, so we have some capacity there. Also, we could use Teflon sleeve to reduce the friction co-efficient as a last resort).
- Stretching hysteresis in the sleeve may affect print results (this is down to finding a sleeve stiff enough but still suitably flexible for print movements).

Unfortunately I've knackered the electronics on my machine so I can't test this yet, but finger tests

feel good. Thankfully Adrian's offered to fix me up with some of Zach's latest boards while I'm away for Easter so watch this space.

First reprinted circuit

Sunday, 19th April 2009 by Adrian Bowyer

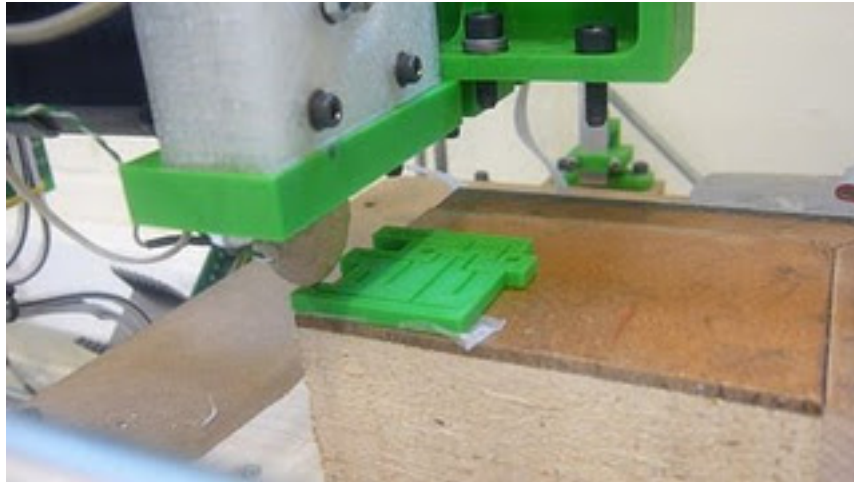

Ed and I have a final-year student - Rhys Jones - who's working on RepRap for his MEng research project. He's been taking the old idea of depositing metal in channels and an observation of Forrest's and Nophead's (that you don't need a low-melting-point alloy because the specific heat of metals is so low that they shouldn't melt the plastic anyway).

He's adapted the pinch-wheel extruder to drive ordinary solder (without core flux - that just makes a mess) down through a thin tube with a nichrome heater wrapped round it.

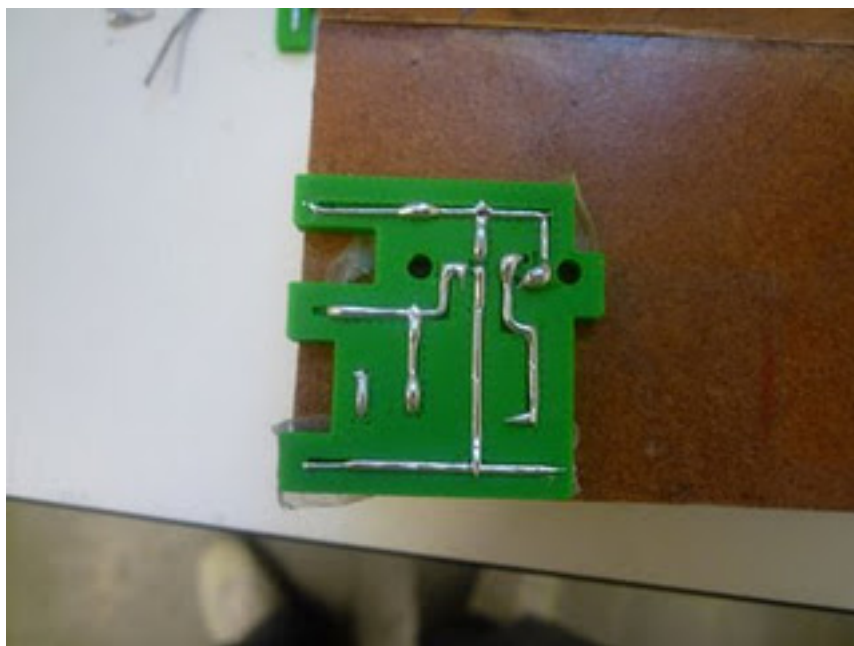

Here's his first circuit. It was made entirely automatically by the RepRap machine. It's a bit blobby,

but...



It's easy to put the components in from the other side. It's the RepRap opto endstop circuit.

Finally, here it is fitted to the RepRap machine that made it and working:

Introducing the Extruder Controller v2.2

Monday, 20th April 2009 by Zach Smith



This board has been under development by the RRRF for quite a while, and it's gone through a few different revisions before I felt it was ready for prime-time. This board is a major component part of the new Generation 3 RepRap electronics, and I'm really happy with how it turned out. You can read the full documentation on the board on the RepRap wiki. Oh yeah, and the design is up on Thingiverse if you just want to check out the files quickly.

One of the major problems with the Gen2 electronics is that everything was running on a single Arduino, and that chip just didn't have the power, the pin count, or the memory to run a RepRap machine really nicely. So, with Gen3 I decided to swing the pendulum back a bit towards the Gen1 boards which were completely distributed. With the Gen3 stuff, it's a happy medium: there is a motherboard (which I'll blog about later this week) that can control various slave devices (such as this Extruder Controller). Each of them has its own processor, so they can do things independently.

For example, with the old system, we had to have a temperature check in the same loop that was doing the stepping algorithm. It had to check the temperature between every step otherwise it would either heat up too much or cool down on long moves. This resulted in a slowdown at faster speeds which was really a pain in the neck. However, with the new system, the Extruder controller is responsible for handling temperature and the Motherboard basically just sets it and forgets it. It simplifies the design of both firmwares and life is good overall.

To get into some nitty gritty details, the Extruder Controller v2.x boards have an Arduino onboard (atmega168) and use RS485 to communicate with the motherboard (noise tolerance!). Here's a blurb from the wiki where it has been fully documented:

- * Onboard atmega168 - program it just like an Arduino because it is an Arduino.
- * 3 x MOSFET drivers for controlling up to 14A @ 12V. Perfect for heaters, fans, solenoids, etc.
- * 2 x H-Bridges capable of up to 2A each. Control 2 motors, or control one stepper motor.
- * A temperature sensor circuit for reading the standard 100K thermistor.
- * RS485 connection for noise-free communications with the motherboard.
- * IDC header for connecting a Magnetic Rotary Encoder.
- * Polarized ICSP header for simple, easy programming.
- * It mounts directly to the Pinch Wheel Extruder!
- * It is plug and play with the RepRap Motherboard.

If you want to use one on your machine, you can [get a kit from the MakerBot Store](#). It is a SMT based board, but don't let that scare you off. It's actually pretty easy to get it soldered up. If you absolutely refuse to do SMT, we're planning on having them fully assembled in a couple of months which will make things easier.

Wedgewood X Assembly, Thumbnail Edition

Wednesday, 22nd April 2009 by Vik Olliver

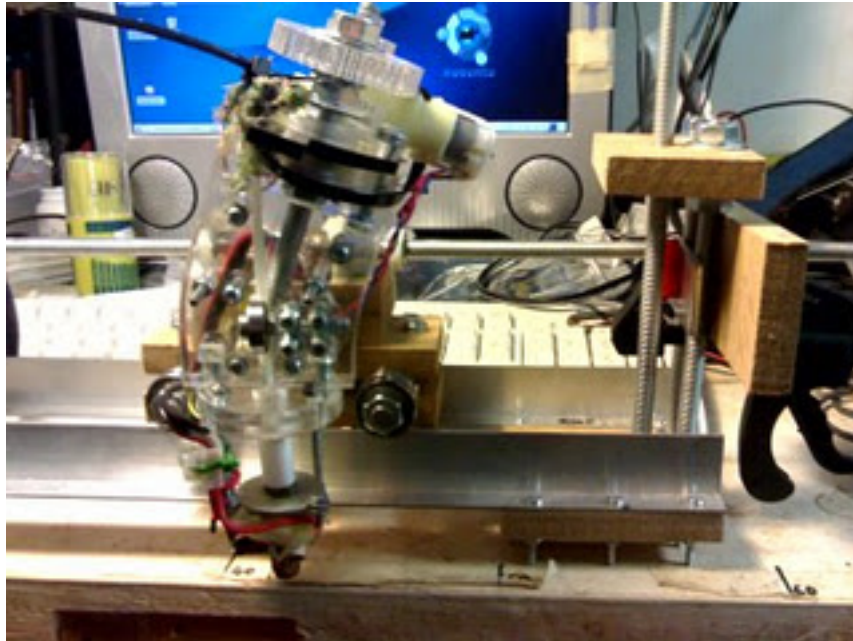

Having drilled my left thumb and nail for M3, I'm now back in the workshop once again and working on Wedgewood. I promised the guys in the #reprap chartoom on IRC ([Chatzilla](#) or similar needed) that I'd give a quick update. As you can see from the photo my good camera is broken too, other than that there is a railcar-like X carriage and on the right a contrivance to dangle it all from the Z axis.

The wheels are made from two skate bearings with a washer between that is thinner than the rail. This causes the bevelled edge of each of the bearings to run on the corner of the top of the rail and self-centre. Runs nice and smoothly, should also be robust enough to dampen oscillations of the drive rod. Yes, that is a Ponoko lasercut extruder (from an old extruder kit) plugged into the X Carriage - both the MDF carriage and lasercut extruder are compatible with the Darwin exchangeable head holder. I love standards :)

The stepper will be screwed to the block on the far right and coupled to the horizontal threaded rod. Probably put a bearing in there to reduce play too as I'm using cheap stepper motors.

Oh, I can also report that brazing thermocouple wire doesn't work - it melts way before the brass. I'll have to locate some silver or 95/5 solder. Flash-welding the stuff is looking more convenient by the day.

Vik :v)

Skeinforge Support

Thursday, 23rd April 2009 by Ian Adkins

I've been trying out the support material in Skeinforge and said I'd post some pictures. The settings have not been fine tuned but I'm still very pleased with the results. The object was a simple test shape it is 100mm tall and 30mm the columns are 8mm x 2.5mm and the column length is 75mm. So quite a delicate shape.

Skeinforge generated a good support structure and it printed OK with our firmware the head goes to a rest position every time the temp changes so it did this approx 500 times (twice every layer) as the support went down at 235°C and the Print at 250°C this in turn lead to lots of hairs coming from the print. I resisted removing them during the print and wanted to know if it would work with Zero intervention, it did :-)

The print took about 1/2 hour to clean up and the support was better stuck than I would have liked, in removing it I broke the columns, this was a little upsetting up until the point I realised I could glue it back together and the join was invisible and as strong as the rest of the model, I also figured that it was not an unacceptable solution as the end result is a very acceptable print (well I think so for zero tuning).



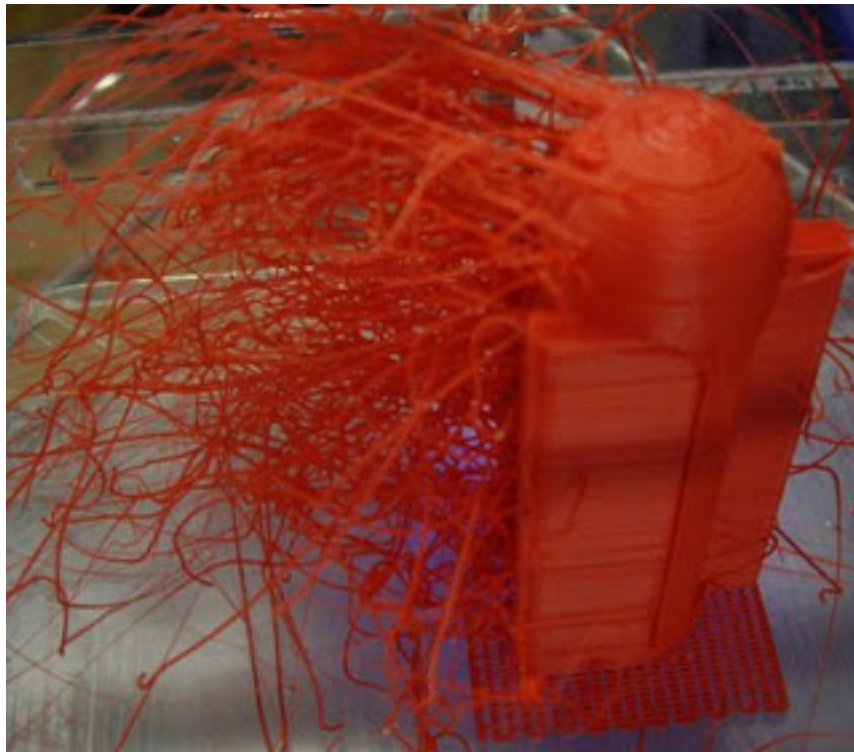

Ian www.bitsfrombytes.com

Introducing the RepRap Motherboard v1.x

Wednesday, 29th April 2009 by Zach Smith

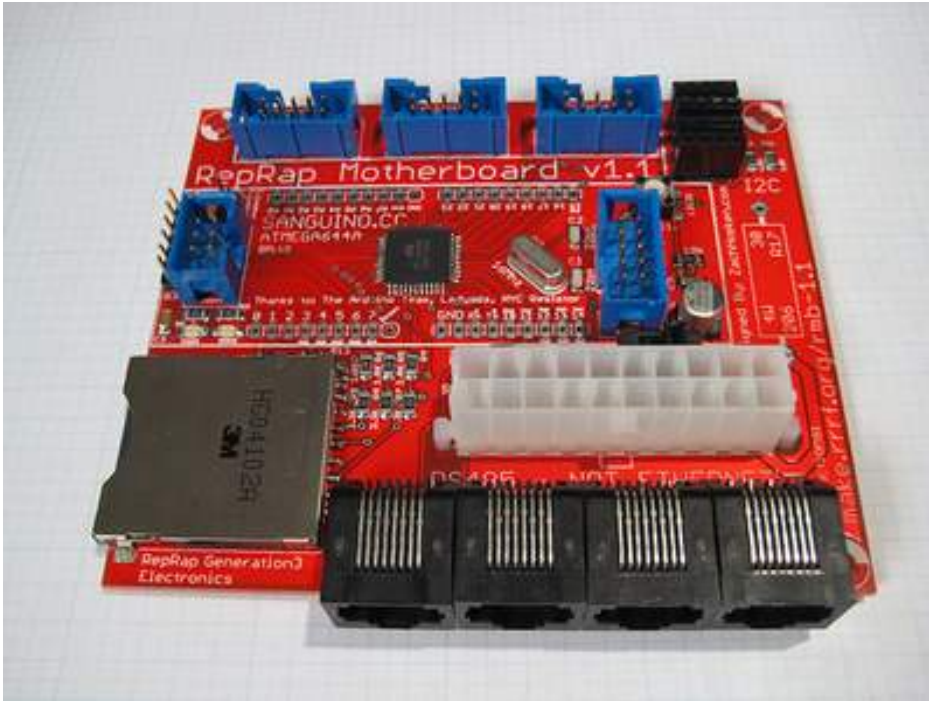

This is another board that has been in development for quite a while that I have done a pretty sad job of communicating to the community about. Well, it's now ready for primetime and a bunch of people have been using them for a while.

The idea on this board is to consolidate the stepper control onto a single board, give it a comms network to control modular 'slave' devices which can control extruders, etc, and also to give it an SD card slot as well as some other cool features. It's based off the Sanguino design.

Anyway, I summed it up much better in the [wiki page](#) :

This board is the brains behind the Generation 3 Electronics. The heart is a Sanguino which is an Arduino-compatible board that is powered by an ATMEGA644P chip. It has connectors to hook up all the various peripherals that you'll need to drive a RepRap machine. It has headers for three stepper drivers, as well as 4 RJ45 connectors for Extruder Controller Boards. Not only that, but it has an SD card and a connector to hook it up to an ATX power supply.

Some highlights:

- * Onboard atmega644p - 64K flash space, 4k ram, 32 I/O pins, Arduino compatible.
- * 3 x Stepper driver connectors with min/max inputs.

- * Built-in SD card socket for printing from file and buffering large print jobs.
- * RS485 connection for noise-free communications with extruder / toolhead controllers.
- * ATX power connector for power. It can also turn the power supply on and off.
- * Headers to allow existing Sanguinos to plug straight in.
- * I2C headers for simple hookup of external peripherals.
- * On/Off switch for instant-kill and simple control of the entire system.

This board was developed by the RRRF and is available for sale from MakerBot Industries as a kit. They will also be available fully assembled in a month or so.

DIY chip fab

Wednesday, 29th April 2009 by Adrian Bowyer

This blog is for RepRap progress, but sometimes things happen elsewhere that deserve a mention too.

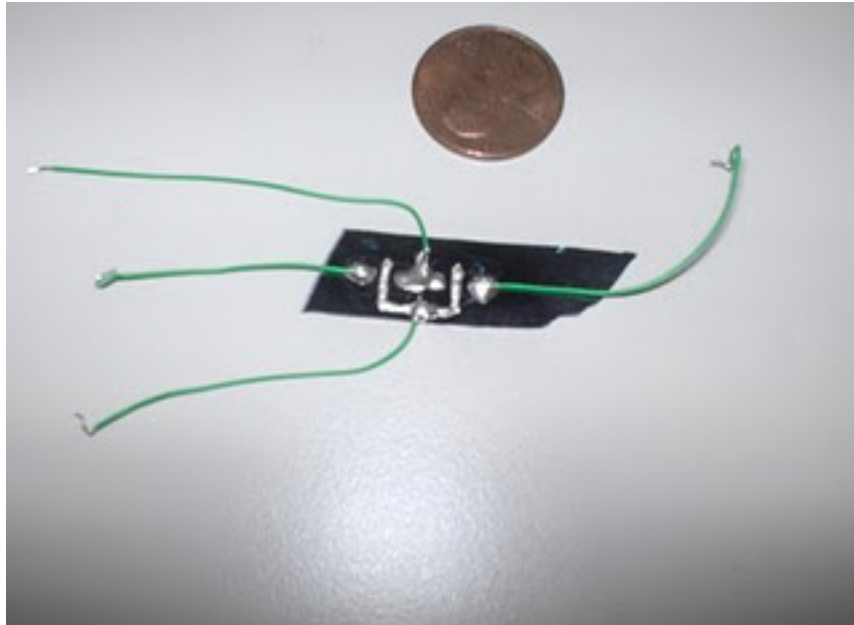

So, thanks to Julian Skidmore for telling us about Jeri Ellsworth, who is doing amazing stuff...

Check out these two links to her work:

<http://www.flickr.com/photos/jeriellsworth/2835524263>

and

<http://www.flickr.com/photos/jeriellsworth/2835459827>

A different approach to extrusion

Thursday, 30th April 2009 by Forrest Higgs

In which your narrator goes nuts...

As you know I've been designing Tommelise 3.0. T3 will be able to be configured either as a printer or a milling machine and is looking to cost about \$150 in parts for the printer option. Obviously, I've got to have an extruder if I'm going to do printing. Heretofore, I've been torn between building a "me, too" pinch wheel extruder or a more robust variation on the Mk II. With what seems like everybody and their Schnauzer building more flavours of pinch wheel extruders than Ben and Jerry's have flavours of ice cream and the formidable Nophead exploring variations on the Mk II, I was left to either wait for the dust to settle or somehow come up with some new wrinkle to those two initiatives that would add something to the state of the art. I frankly couldn't see what I had to offer in that regard.

The dust hasn't settled yet on extruder designs. A clear favourite hasn't been clear to me at all. Most pinch wheel designs, while simple, require heavy NEMA steppers. I haven't been too happy with that. Nophead's, pinch wheel design and his variations on the Mk II, while light, require machined parts. I'm not happy with that, either.

That left me wondering whether there was a third way of designing a workable extruder that was both reliable, light and required no machined parts that couldn't be milled or printed on a Reprap machine.

I got to thinking about threaded nuts, for some reason. The problem with threaded rods is twofold. First they have to have bushings. You have to mill those and the damned things wear and create metal dust which gets into your extruded plastic if you don't break the system down and clean it quite frequently. Second, the threads curve away from the filament, which means that the threads have to cut quite deeply into the filament to get a proper grip.

A nut, on the other hand, curves around the filament, giving a much larger contact area. In the past there was a notion that you ought to be able to thread a nut onto the filament. The problem with that approach is that the filament tended to turn with the nut. I came up with a different approach.

I used a nut considerably larger than the filament and then milled a filament guide {the black HDPE part just above the ruler} that pushes the filament against the threads.

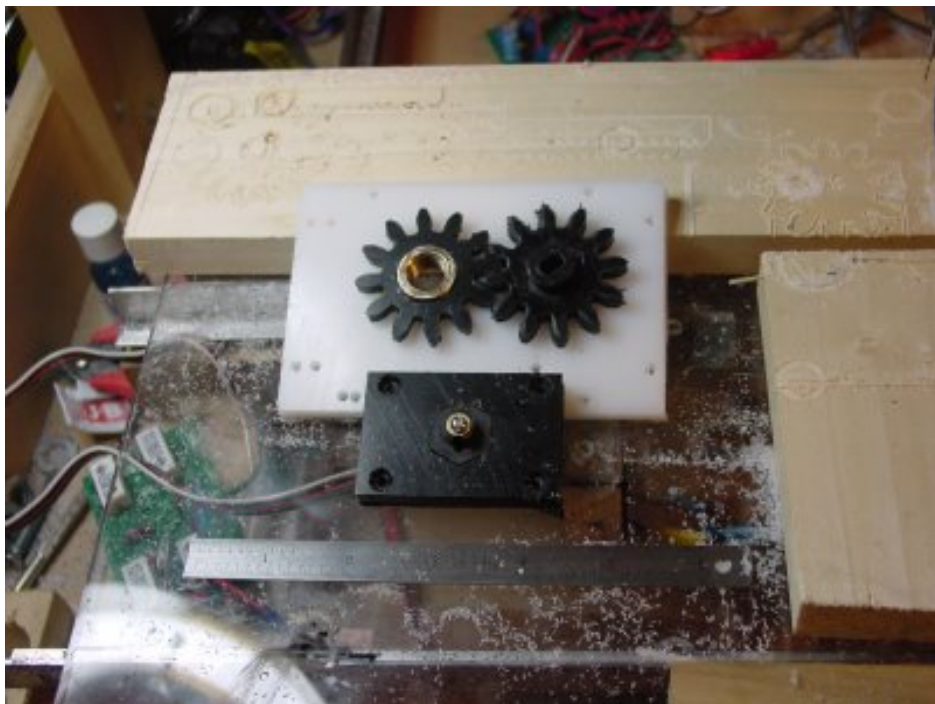

The nut, I embedded in a gear and drove that with another gear connected to the drive shaft of the gear motor. The bushings and drive shafts are milled out of HDPE and are made with large diameters to keep the contact area between shaft and bushings large and the force per unit area small. Given that HDPE is about as slick as Teflon friction isn't a problem.

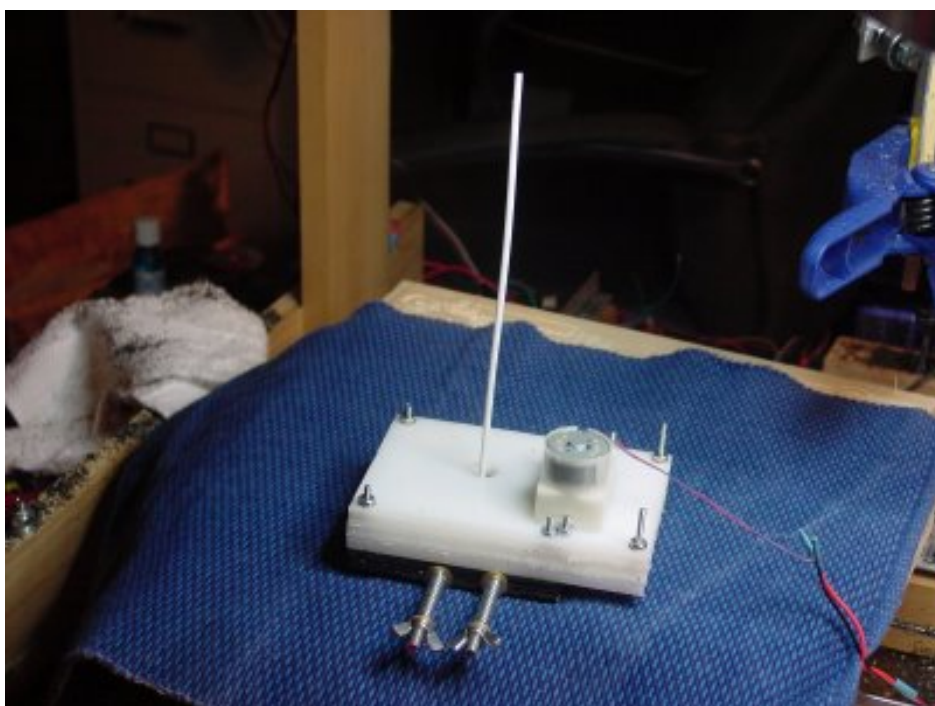

The black filament guide is connected to the Z-axis and the filament pump floats free. The two #8 threaded rods with wingnuts and springs provide the compression required to let the filament engage the threads inside the nut.

Tentatively, I am driving the system with a Solarbotics GM-17. Should that not be effective, I can

shift to a 12v GM-3 which has about 60% more torque. Should that not be adequate I can always use Nophead's tin can stepper driven GM-17 gearbox.

I've already demonstrated that this ensemble will pump ABS. I have not measured how much force it can apply to the filament, though I suspect that it is substantial. The design has a number of advantages.

- at 280 grams, it is light.
- it requires absolutely no especially machined metal parts.
- it can be milled, printed or laser cut {most of the parts for this last}.
- the feed rate can be increased by two-thirds simply by swapping the 1/2-20 fine pitch nut for a 1/2-12 coarse pitch nut.
- it can process both very stiff and highly flexible filament with equal ease.

If you had to you could probably cut these parts out of HDPE with a scroll saw.

I will be seeing if I can get this extruder running properly and assess it's robustness over the Summer.

Late addition: I was able to get down to the hardware store this morning and get the requisite #8 nuts, washers and lock washers that I needed to complete the extruder filament pump. The compression springs that you see in the picture are adequate and the extruder pumps ABS at 5v. I was also able to acquire a spring scale like Nophead uses at the hardware store as well, so I should be able to get an idea of how well it pulls very soon.

Documenting the Mk I Nutjob

Sunday, 3rd May 2009 by Forrest Higgs

Nophead: *This looks really promising, but I am having trouble understanding the physical arrangement from the photos. Any chance of a view from underneath, or a diagram?*

Forrest: *Absolutely...*

I had a few minutes Friday to run some tests on the Mk I Nutjob. Using a GM-17 it was able to generate several kilograms of thrust, which, from Nophead's research, should be enough to extrude ABS.

Frankly, though, I couldn't see that having enough torque to just extrude was going to be that much fun. Tommelise 1.0 taught me that operating on the edge of an extruder's capabilities is a frustrating exercise at the best of times and a waste of time at other times.

The diameter and shaft diameter of the little coreless DC motor in the GM-17 is a common one. A variety of more capable, read that longer, DC motors can easily be slotted into its place. Indeed, Solarbotics is looking for an upgrade motor for the GM-17 not unlike the 12v upgrade that they have for the GM-3.

At that point it occurred to me that I could easily do the GM-17 hack that Nophead demonstrated a few days ago. I certainly had exactly the Jameco tin can stepper that he used and I also had the ability to mill a special mount for it.

Nophead's mounting plate was, as usual, elegant.

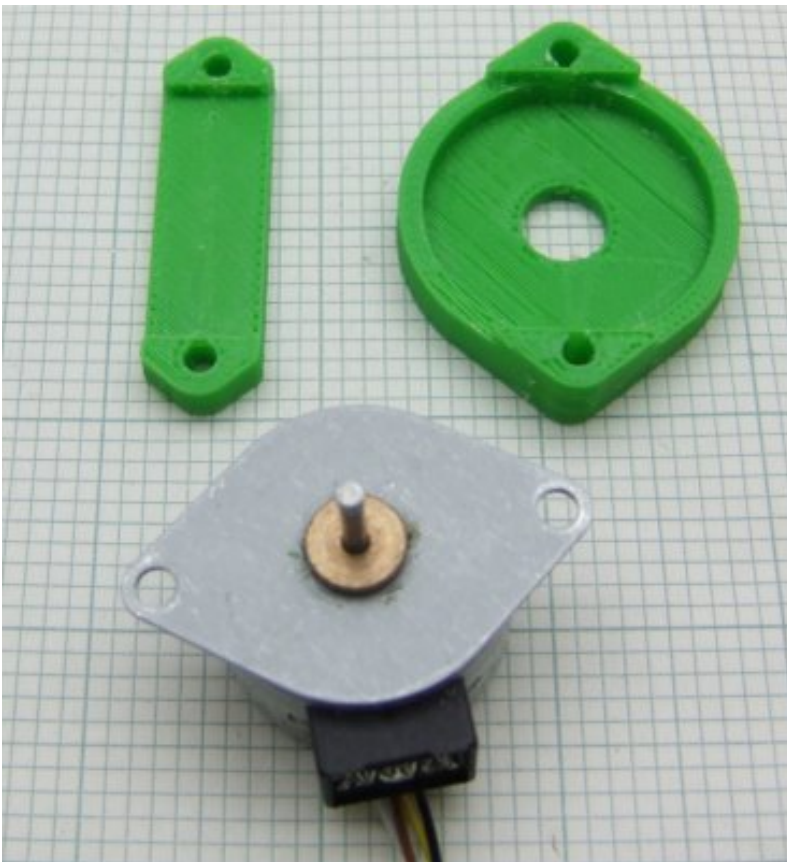

It would have been quite easy for me to mill it save one little issue.



The ventral strap simply didn't work well for my extruder. As a result, I designed an alternative that made use of the extant mounting points on the GM-17.



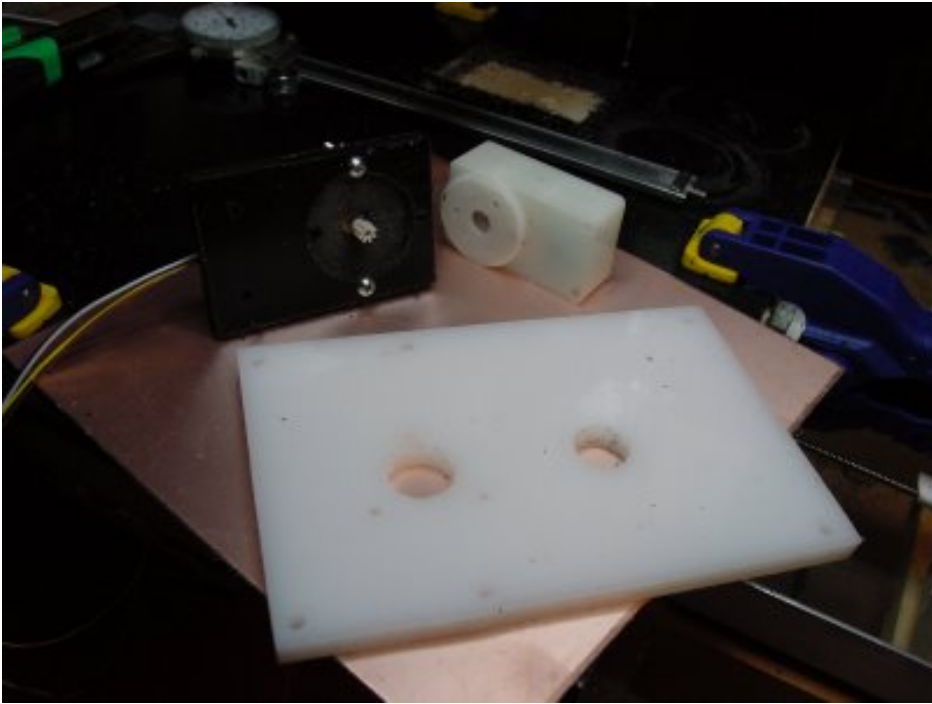

At that point I was ready to do the photodocumentation that I promised Nophead.

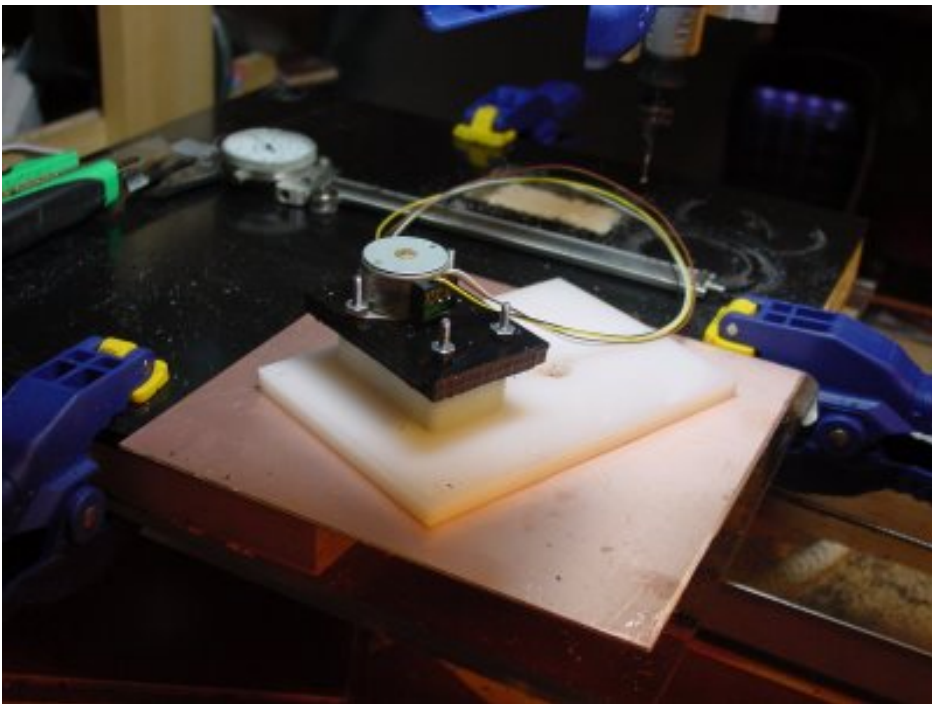

Here you can see my interpretation of Nophead's GM-17 hack mounted on the top plate of the extruder.

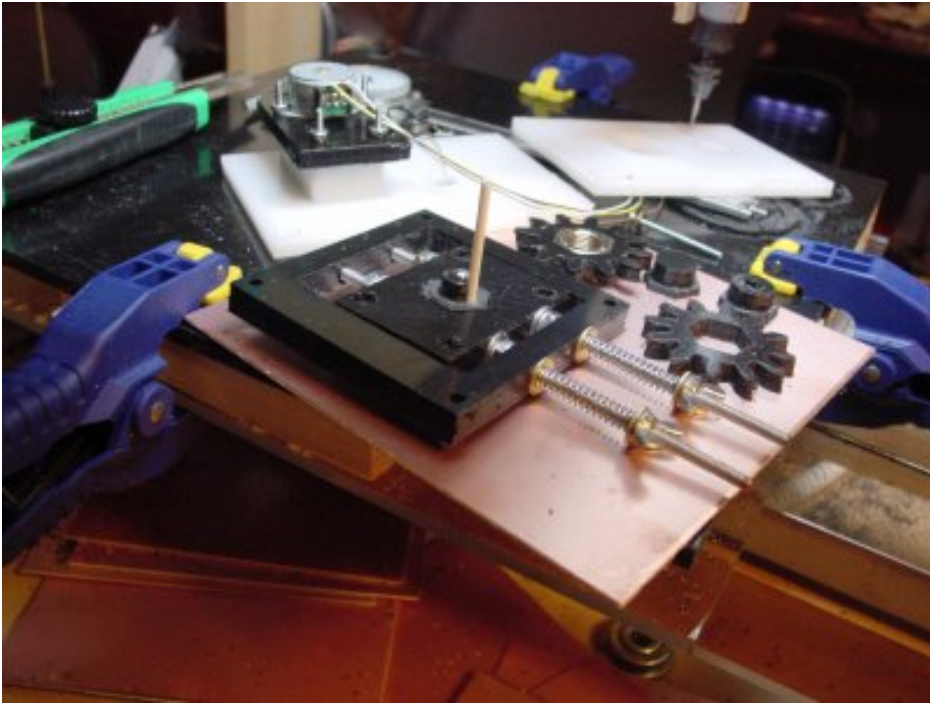

Starting from the bottom of the extruder, you first see the spring-loaded guillotine mechanism that holds the filament guide against the nut threads.

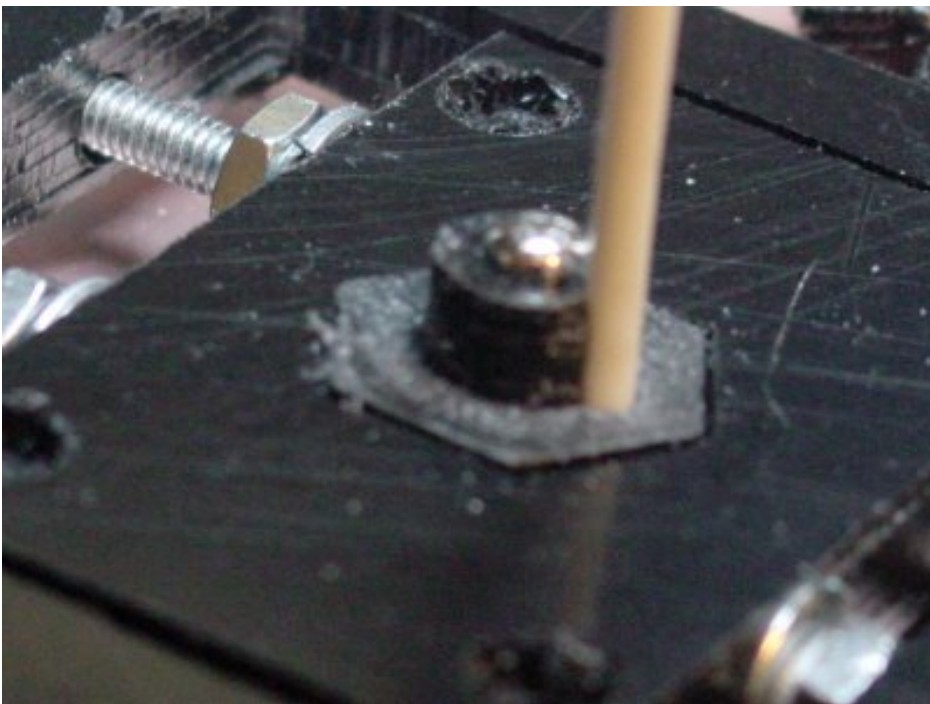

Here is a closeup of the filament guide. I designed it as an insert into the plate that is attached both to the extruder barrel and the z-axis. The mounting holes are plainly shown .



Power is carried from the GM-17 via a transfer gear. Here you can see that I milled it in three pieces to reduce machine time on Tommelise 2.0.



There has been considerable confusion about the embedded nut gear. Here you can see the bottom side of the gear from which a shaft protrudes which accommodates the full height of the nut, more or less. There is no shaft on the topside of the gear and the top of the nut simply butts up against the top housing plate, which serves as a thrust bearing.

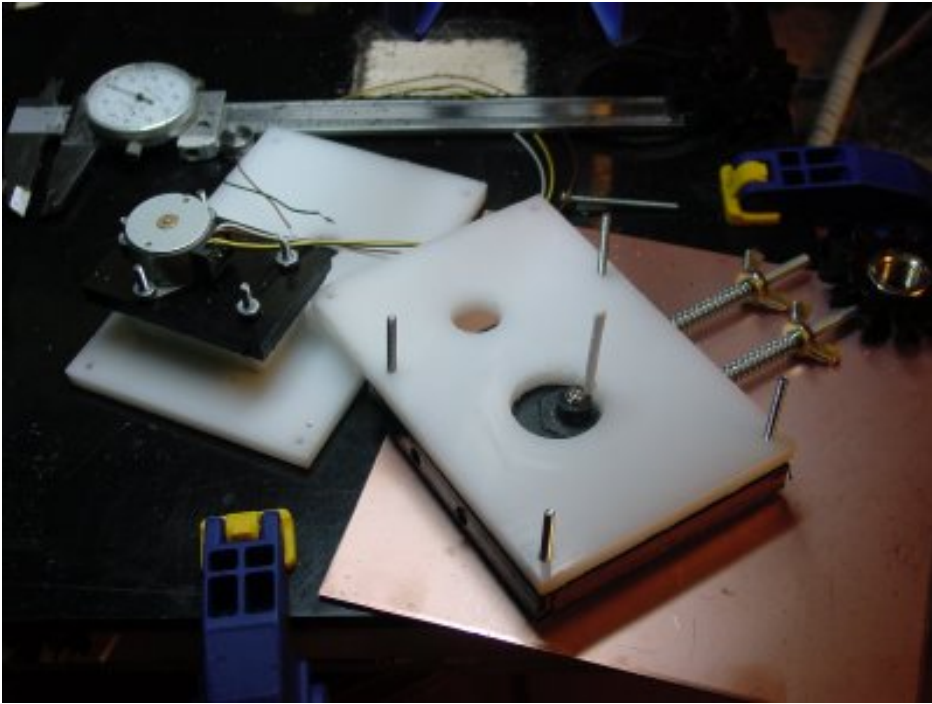

Now the bottom plate of the extruder slides onto the four #4 bolts in the filament guide frame. For you metric types, #4 bolts and M3 are pretty much the same diameter, though the pitch is, of course, different.

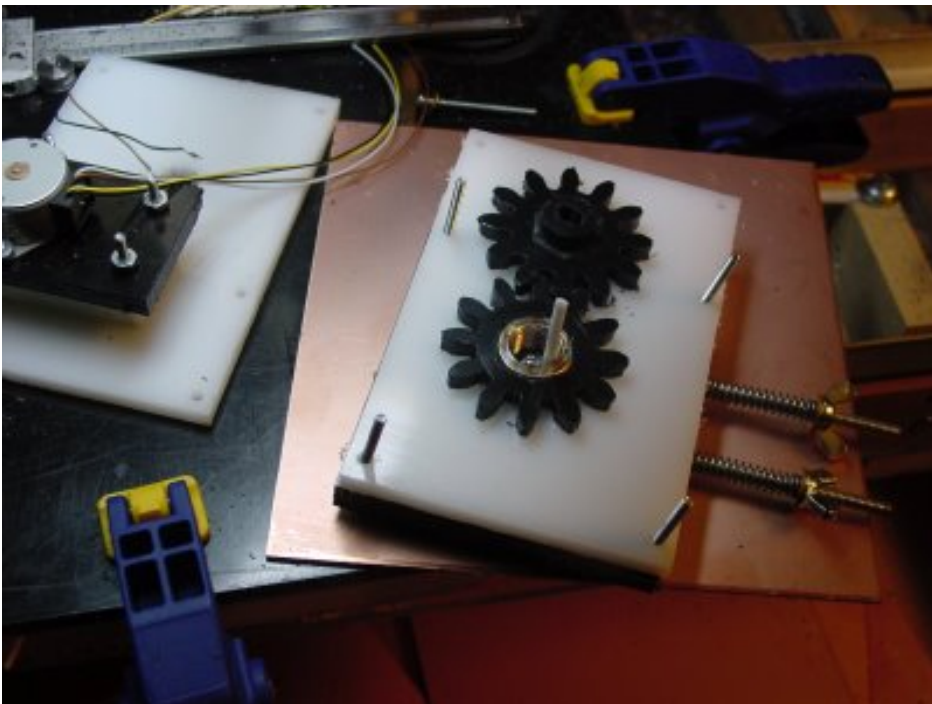

Once the bottom plate is mounted, fitting the drive gears is very straightforward.

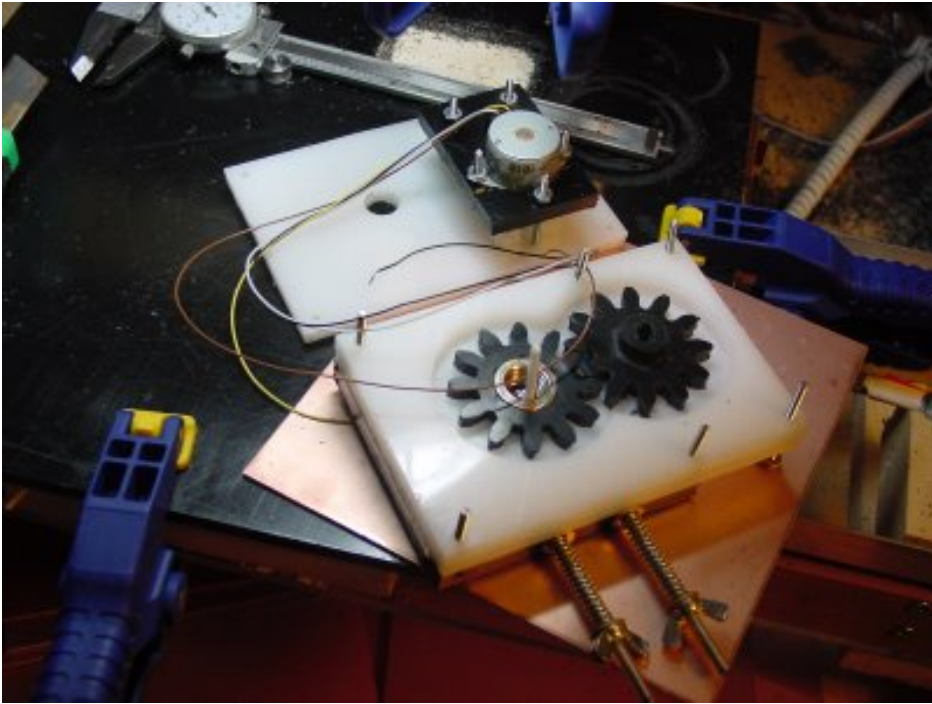

Once the gears are in place the spacer plate slides onto the mounting bolts.

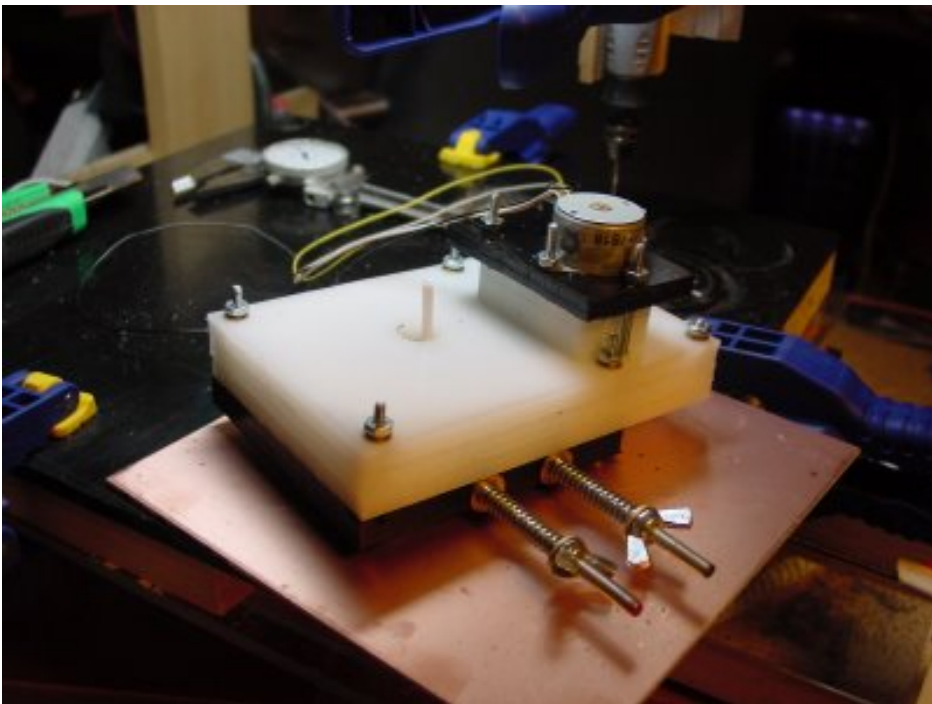

From there it is a simple matter of sliding the top plate with the GM-17 hack onto the bolts and applying the washers, lock washers and nuts to them to complete the assembly.

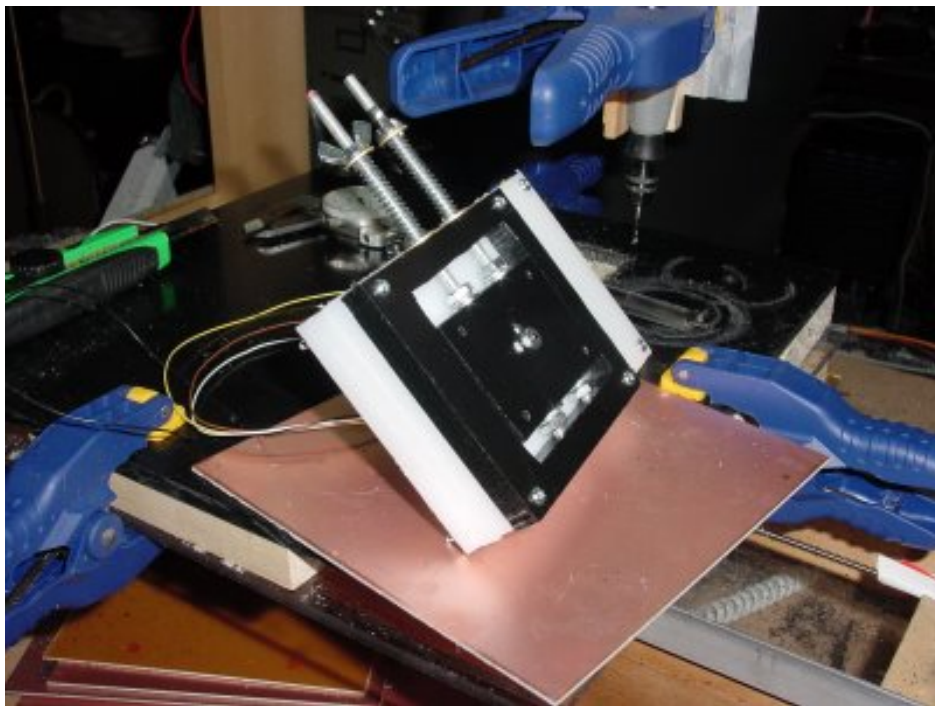

Finally, you can see the bottom of the assembly in this photo. with luck, I'll be able to test it within the next few days.

Stovetop recycling of HDPE swarf

Sunday, 3rd May 2009 by Forrest Higgs

In which your narrator solves the problem of recycling plastic scrap, for milling...

One of the great unsolved problems for Reprap has been that of either figuring out how to make plastic filament locally from scrap or how to design an extruder that can digest scrap. Reprap has successfully created a 3D printer for less than \$1000 that replaces a commercial machine costing anywhere from \$30-50,000. A plastic grinder and monofilament production machine runs anywhere from \$75-100,000 and, unlike a commercial printer, can weigh several tons.

For milling, as opposed to printing, I've discovered that recycling can become much less challenging. Years ago in South Africa, I encountered a plastics fabrication technique called Rotary Moulding or Rotomoulding. Typically, you dump a measured amount of polymer powder into a big steel mould and secure it to a motorized gimbaled drive in a heated enclosure. The steel mold becomes slightly hotter than the melting point of the plastic while the tumbling action of the gimbaled drive coats the inside of the mould with plastic powder.

The method is used to make everything from the petrol tank on your automobile to portable toilets and large water tanks.

One guy I got to know in Pretoria back in the 1980's was using HDPE swarf to rotomold bins and water tanks.

Yesterday, I got to thinking. I'm buried in fine HDPE swarf and I need HDPE sheet. Could I modify the rotary moulding technology to create it. I took an old teflon coated frying pan that I didn't need any more and heated on my stove to about 220 C, checking the evenness of the surface temperature with my handy-dandy IR thermometer.

At that point I began sprinkling a couple of cups of milling swarf on the heated teflon surface. Interestingly, the swarf, being heated from below, tended to melt into the already melted surface without trapping large air bubbles like happened with my experiments some years ago to melt HDPE scrap in a toaster oven.

Once I ran out of swarf I cooled the pan and plastic down in cool water, then peeled the melted swarf out of the pan and cut it in half to see how thick it was.

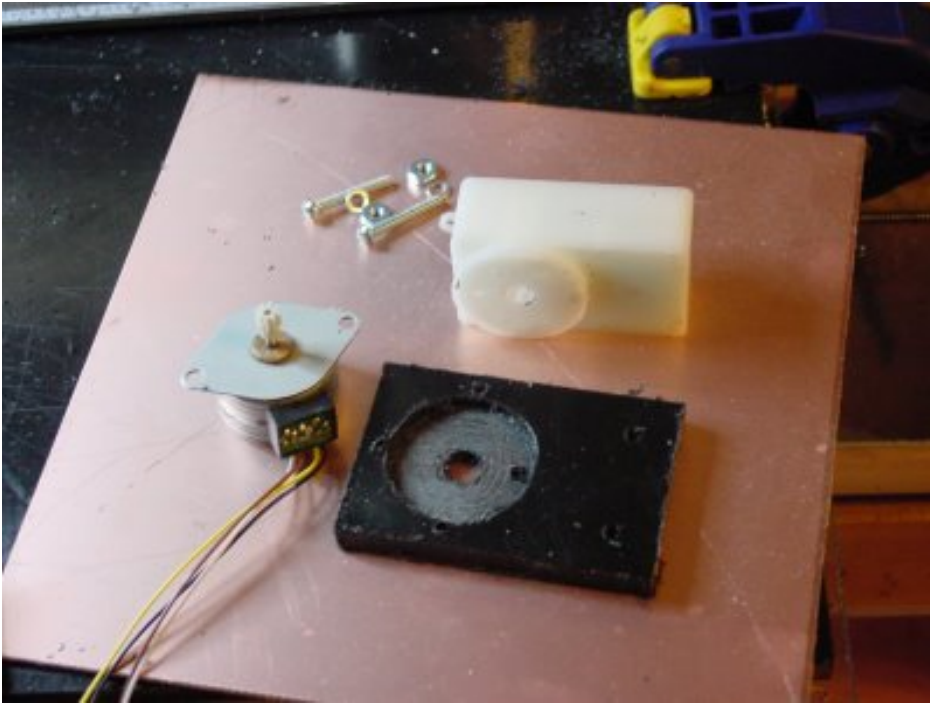

The bottom surface is very slightly porous, though not enough to leak water. The top surface is rough with unmelted swarf and a few bits of poplar.

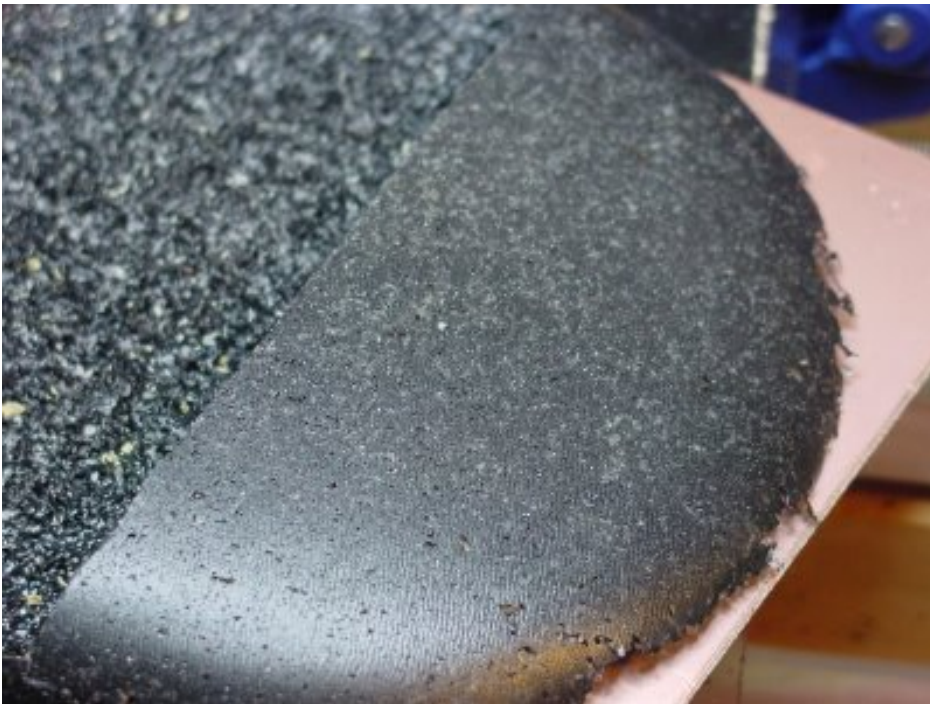

Here you can see the thickness of the melt, 2 mm. It would have been thicker except that I ran out of swarf. The slightly mottled colouring of the melt reflects the mix of white and black swarf that I had.

With thicker melts I could simply mill off a flat top surface. The need for that could be reduced by using a small aluminum rolling pin to flatten the top.

Now I have to either buy or mill a small hand vacuum cleaner to collect the swarf in a more orderly manner than I do presently by using compressed air.

Taking the Gm-17 out of Nophead's GM-17/tin can stepper hack

Tuesday, 5th May 2009 by Forrest Higgs

Reducing the vitamin content of the Mk I Nutjob extruder...

These past few months have been very frustrating for me vis a vis Reprap. My day job has got intense to the point where there is little time for Reprap and worse still, the little time there is finds me mentally exhausted and incapable of working efficiently on Reprap work. In a less stressed time I could have designed and built the Mk I Nutjob over a couple of weekends. As it is, I've been working on it for since the New Year. Focussing has been hard.

Last weekend, things began to come together. I now have an assembled polymer pump using a nut as the threaded pump and it appears to work pretty well.

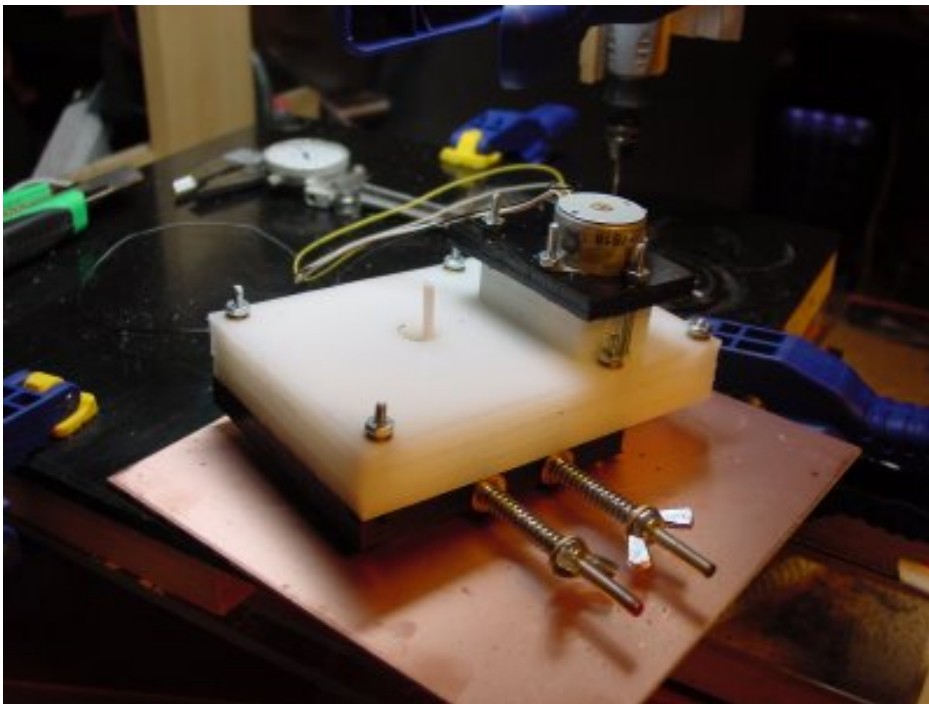

The pump has no problem biting into and moving ABS, HDPE and homopolypropylene. With the 228:1 standard gear ratio it moves a bit over 7.3 mm/minute. If I reduce that to 51:1 using the Dietl gear kits that Solarbotics sells it appears that I can extrude at a rate of 15-20 mm/sec.

Nophead's GM-17/tin can stepper hack really delivers the power. I ordered four more GM-17s and the Dietl Rome gear sets to work with.

Having done that I looked at what Nophead's hack was actually costing. The GM-17 costs about \$5-6, the Dietl gear set about \$4 and the tin can stepper from Jameco about \$7. Figure \$17 dollars to get a lightweight, powerful, stepper-driven gearmotor. I can get a NEMA 17 that does the same job for that price without a lot of trouble. It's heavier, but hey?

That got me to thinking about the GM-17 gearbox. I don't use the little coreless electric motor. I'm paying \$10 for a gearbox with about as much plastic in it as one joint of my little finger.

Quite some time ago, I was milling small gears and racks. They weren't very good. Since then, I've got a lot better at milling, but I haven't gone back to milling small things again. Before work this morning I decided to see if I could do a better job with my increased know-how.

In fact, I could.

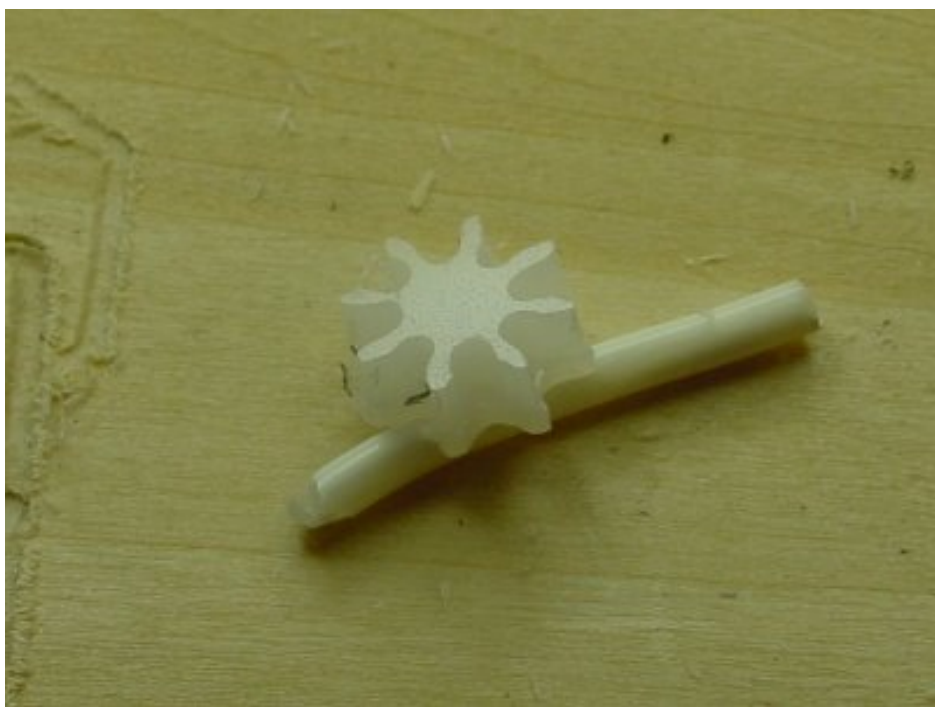

What you see is a pinion gear suitable for pressing onto the 2 mm drive shaft of the tiny tin can stepper used in Nophead's hack. The cylinder under it is a piece of 3 mm filament. The pinion has a pressure radius of 5 mm.

Looking at the success of Nophead's hack, it is obvious that it is best not to have a lot of mass in the initial, high-speed gears in a gearbox. While my 10 mm pinion gear isn't as tiny as the GM-17's, it weighs a small fraction of a gram. It is also the hardest gear to mill.

I did some partial cuts of pinion gears with higher cut quality. My z-axis on T2 is a bit cranky this morning, however, and I wasn't able to successfully complete them before I had to quit for work.

Interestingly, gears of this size and thickness only take a few minutes to cut.

I will be using the GM-17/tin can stepper hack to work the bugs out of the Mk I Nutjob. Afterwards, however, I will be taking a very hard look at taking the GM-17 gearbox out of the vitamins column of Tommelise 3.0 Sampo.

4D Printing

Thursday, 7th May 2009 by Adrian Bowyer



Wot? Another coat hook? So what's new here?

The fact that it was printed in four dimensions, that's what. I've upgraded the Java host software and the Arduino/Sanguino G-code firmware so that the system treats the filament length to be extruded in each movement as another independent movement variable, like X, Y, and Z (as [proposed here](#); you've got to have a stepper-driven extruder - like the [pinch-wheel extruder](#) - for this to work).

That is to say, the DDA in the firmware, which previously generated straight lines in (X, Y, Z) space, now generates straight lines in (X, Y, Z, E) space, where E is the growing length of extrudate needed.

From the outside, this means that everything works exactly as before. So why bother? The reason is that it makes it a lot easier to do tricks like accelerating and decelerating the extrude head as it moves, which means that it can both go faster and run on less current. This will be the next thing that I do.

I've done a new release of the host software in the repository [available here](#), and written an upgrade to the Arduino/Sanguino firmware called `FourD_GCode_Interpreter` [available here](#). To turn on 4-dimensional behaviour, simply set the flag `FourD=true` in the `reprap.preferences` file. Set it false to make the machine work as it did before.

Perhaps surprisingly, the firmware doesn't need to know if it is being driven in 4D mode or 3D mode. Lines in the G-code now look like:

```
G1 X23.9 Y39.0 Z0.2526 E66.5 F3000.0 ;print segment
```

G1 X23.9 Y39.7 Z0.2526 E67.2 F3000.0 ;print segment

So, for example, the second line is saying move 0.7mm in Y from where you last were and extrude 0.7mm of filament while doing so, all at 3000 mm/minute. But if you leave the Es out and turn the extruder on and off separately, everything works just as before (so old G-code files will still work). You can still control the extrude rate separately too - just set the extruder to go at a different speed to the carriage, and everything comes out right automatically.

Unsurprisingly in retrospect, this taught me something about the control of the stepper which drives a pinch-wheel extruder: you don't want to turn the current off between plotted segments. If you do, the stored spring energy in the compressed filament and the pressure in the melt chamber cause the stepper to slip back (as no current is flowing to hold it) at the end of one line segment and before the start of the next, resulting in a poor-quality build. The new firmware turns the current on when the extruder is first used, and leaves it on until the temperature is set to cool. The latter is a bit of a hack (and we could easily add a "current off" M-code instead), but in practice it works very well. The resulting build quality is excellent.

One final thing: I have only tried the firmware in the Sanguino, and not the Arduino. I can see no reason why the latter shouldn't work, though. Let me know...

The No-Lathe Barrel & Nozzle

Monday, 11th May 2009 by Vik Olliver



In true Open Source fashion, I've been distracted by the attention given to extruders without a lathe and I've figured out how to make an extruder barrel and nozzle without one too. I used some handy but unlikely pre-formed components: A telescopic radio aerial and a posidrive machine screw. To repeat the trick, you'll also need some PTFE tape, kapton tape (or fire cement), 3mm inside diameter silicone tubing, nichrome wire, nuts, bolts, and bits of MDF or similar wood product. You will need a drill that can reliably make a 1mm hole €“ finer if possible €“ for the nozzle's exit, plus the usual hand tools. The coil of wire on the right is an improvised rheostat made from the guts of my expired fan heater (thanks for expiring it, Kate).

I Started by dismantling the telescopic aerial, removing the base and very tip so I could slide all the bits apart. Find the tube that is a snug fit on an M3 or M4 posidrive machine screw. Note that one of the ends of the tube has a shoulder turned over on the end of it that stops the other bits of aerial slipping through €“ this will be the nozzle end. Chop off 50mm of tube and smooth the cut end.

Economic note: More tubes with shoulders can be made by cutting lengths with a pipe-cutter and gently hammering the cut end over, allowing one to make several barrels from one aerial.

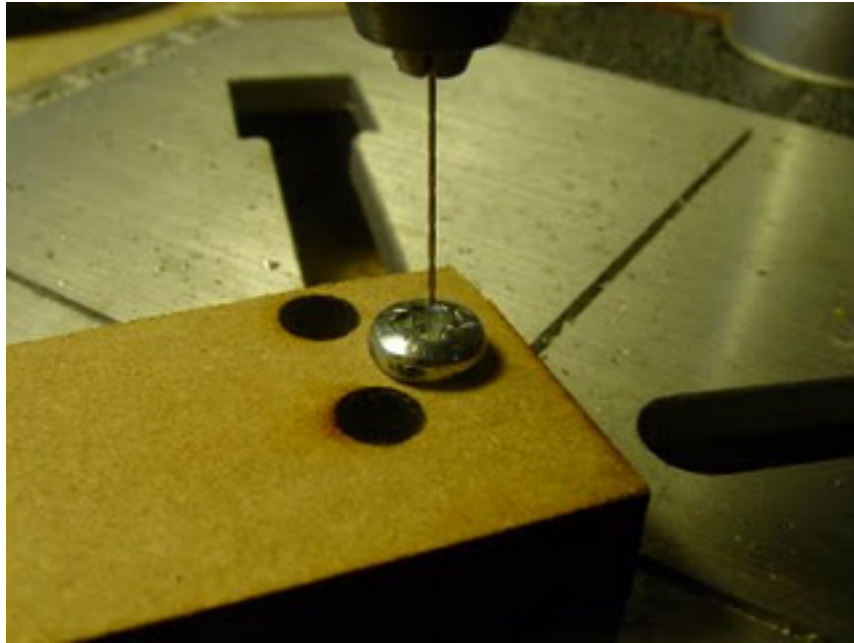

Anchor the posidrive screw in a bit of wood with a nut to make it easier to clamp or handle. Using the dimple in the top, drill 5mm into the screw. Make a 1mm one first and try finer ones when you get the hang of it. Lubricate with thin oil or WD40 and keep the swarf clear. When you're done, clamp the screw in a vice, file of the head and make it a bit pointy so you're left with something that looks a lot like the one below (it's standing in a nut so I could take a decent picture):





Hack off the top 5mm of the screw, tidy it up, and drill a shallow 2-3mm hole on top of the small hole you exposed with said hacking. You should now have something like a little grub screw with a hole through it. Why not put a hole through a grub screw? 'Cos I got no M3 or M4 grub screws. That is your nozzle.



So wrap the little beast with PTFE tape and pop it down the barrel that you cut off the aerial pointy end first. It should wedge itself in the shoulder at the other end. If you push too hard you'll deform the barrel and pop the thing out the other end. Bad move.



Insulate with kapton tape, add 6-7 ohms of nichrome wire near the nozzle, insulate again. That's your heater.

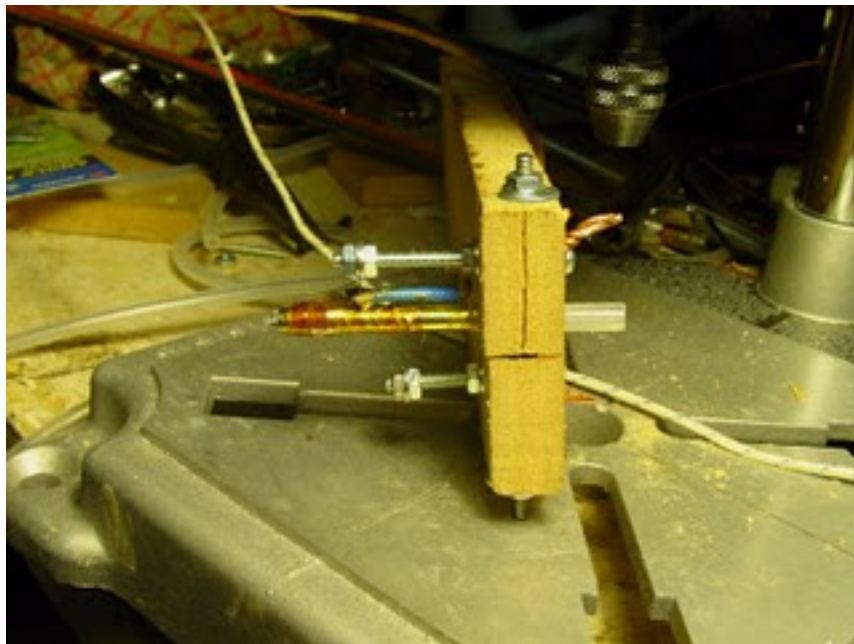

Slip 10mm of a 25mm length of 3mm ID silicone tube over the open end of the barrel and clamp it all in MDF. I found it necessary to add an MDF slip over the top part of the silicone tube later on to stop the soft plastic bulging within the tube. I used bolts to connect up the power to the nichrome and kapton-taped a thermistor probe to the side. The combination works well up to about 180C with PLA and is stable at temperatures of up to 300C by which time the PLA starts coming out as smoke rings. Surprisingly, the silicone stops the MDF from burning.

So there you have it. Easy to get bits, easy to make, no lathing.

Sourceforge Award Nomination

Wednesday, 13th May 2009 by Vik Olliver



The RepRap Project is nominated for the "Project for Most Likely to Change the Way You Do Everything" category of the Sourceforge awards. If you think we're deserving of said title, click on the image and help swing the vote our way!

Vik :v)

No-Lathe Extruder Pops Out

Thursday, 14th May 2009 by Vik Olliver

I'm having difficulty stopping the barrel of the no-lathe extruder popping out. As the silicone warms up it seems to lose its grip on the barrel and the latter slowly slips out of the silicone/MDF clamp.

This combined with the extra material called for in the form of silicone tube is bringing me back closer to Forrest's and Nophead's extruder designs with long, thin-walled barrels and some form of heat-sink near the inlet.

Vik :v)

Small Melt Zones Look Good

Friday, 15th May 2009 by Vik Olliver

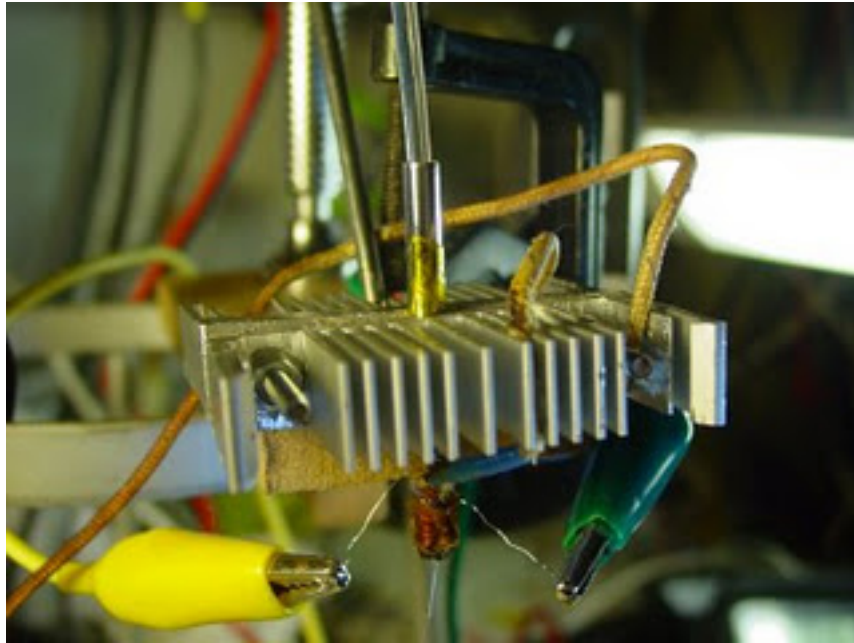

The difference in operation of the no-lathe extruder with different barrel lengths and a heatsink leads me to suspect that the main factor in reducing friction is to reduce the size of the zone where the plastic is actually melting.

As you can see in the photos I've chopped an old CPU heatsink (easily salvaged or made from copper/aluminium stock) into 10mm slices, and clamped a pair around the barrel. There is a recess in the middle of the two halves made with a drill 0.5mm smaller than the barrel's external diameter. I have experimented with moving it up and down the barrel. The barrel above the heatsink does nothing useful in this setup, but might be useful for guiding the filament later.



The heatsink stops the plastic melting on entry, keeping the top part of the barrel under 60C. I've rewound the heater to start the coil as close as possible to the nozzle, and to keep the windings close together. Kapton tape is great for this!

Best results definitely seem to be had with a small, powerful heater (1A@13.8V max, running at about 60%) and the heatsink placed as close as possible to the heater windings. This is much more successful than my earlier experiments with heatsinks.

The extruder works continuously, or in bursts, and I checked that it will restart after cooling. It still needs no lathe!

Vik :v)

Some notes on the way to an easy-to-make

pinchwheel extruder

Friday, 15th May 2009 by Forrest Higgs

In which your narrator experiments with ways to make [Nophead's GM-17/tin can stepper hack pinchwheel extruder without a lathe...](#)

After working for a while with the Nutjob extruder, I came to the conclusion that it was too big, complicated and didn't perform well enough. I backtracked and decided to use my knock-off of Nophead's GM-17/tin can stepper hack and do a pinchwheel. I had a problem, though, in that I didn't really have a lathe that I could use to make a gripper like Nophead did.

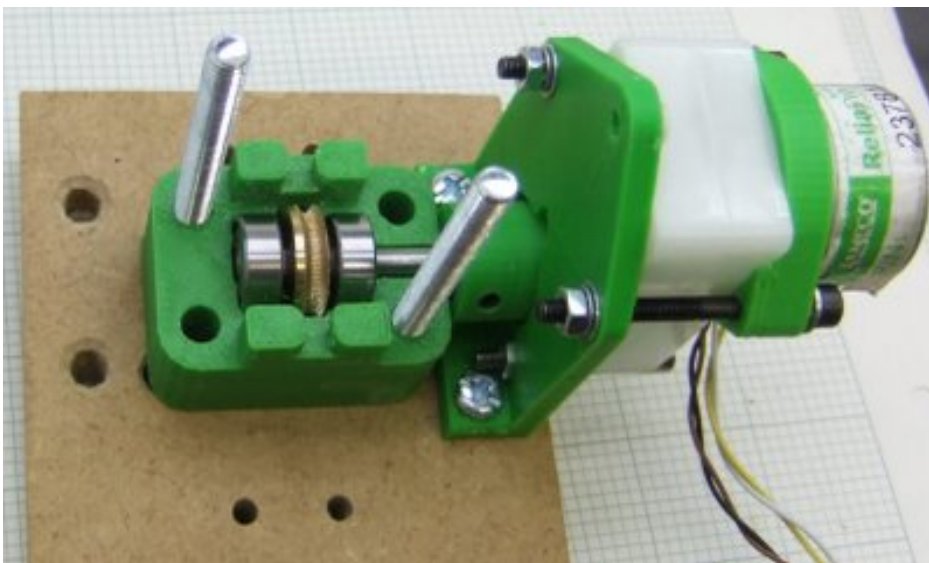

Looking over his work I decided that I could make something like the knurled pinch wheel that he had also tried.

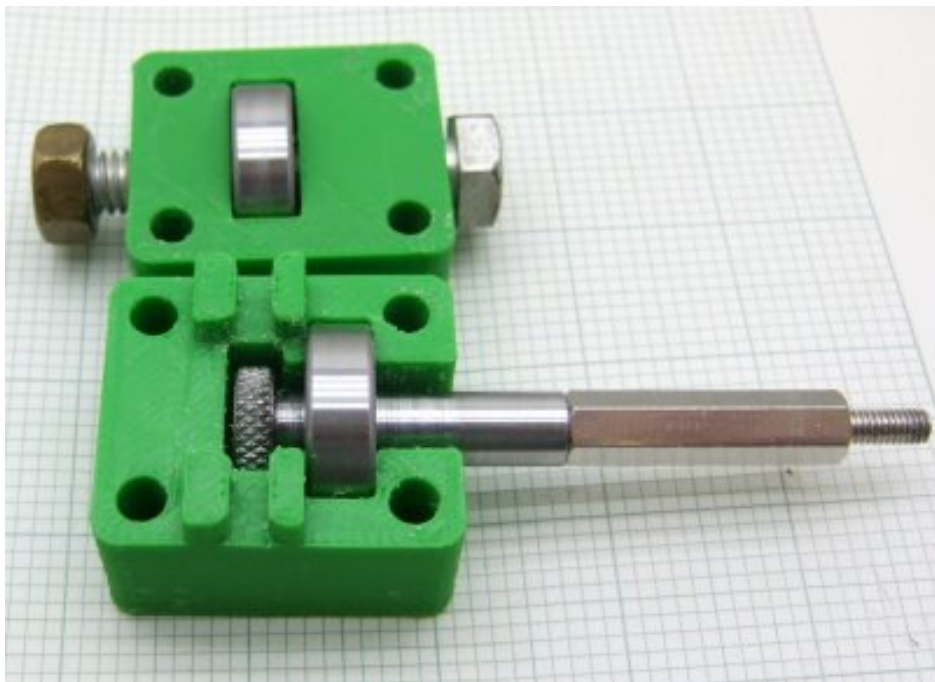

I took an hour off Sunday and spent time at my local hardware store seeing if there was something I could use as stock to do such a knurled concept pinch wheel. Sure enough, Ace had some nice stainless steel bolts made for hex wrenches.



I figured that I could use my little diamond cutting wheel to cut some knurling into the business end of one of these. Notice that I've gone for 3/8-16 bolts which go with the flanged, 3/8ths inch bearings that I have lying about from Tommelise 1.0 days. I'd have probably gone for an M8 bolt and skateboard bearings except they didn't have this kind of bolt in M8, this being the US, and the surf and skateboard shop where I can get M8 bearings is closed on Sunday. Pay attention! This is how critical design decisions are usually made, by me at least. :-)

I bought two of these stainless steel bolts so that I could afford some mistakes. Being Scots-Irish and the bolts costing \$2.80 a pop, I wasn't excited about making a lot of mistakes. It wasn't long before I ran into design reality when I discovered that cutting knurling into what turned out to be a very hard stainless steel bolt was more than I could deal with.

Another reality I encountered was that for milling the thickest sheet stock I had was 3/8ths inch. Making a connector between the GM-17 gearbox and the bolt was going to require something a bit thicker than that. I either had to order thicker stock, which is expensive, or bolt two thicknesses together with a few #4 machine bolts. That was awkward and I had serious questions about how something like that would hold together with the torque loads that were going to be generated.

I started fooling around with some scrap that I had to see if I could solve these sorts of problems. The first thing that seemed promising was when I simply cut paths parallel to the bolt axis in the threaded part of a piece of 3/8-16 threaded rod.

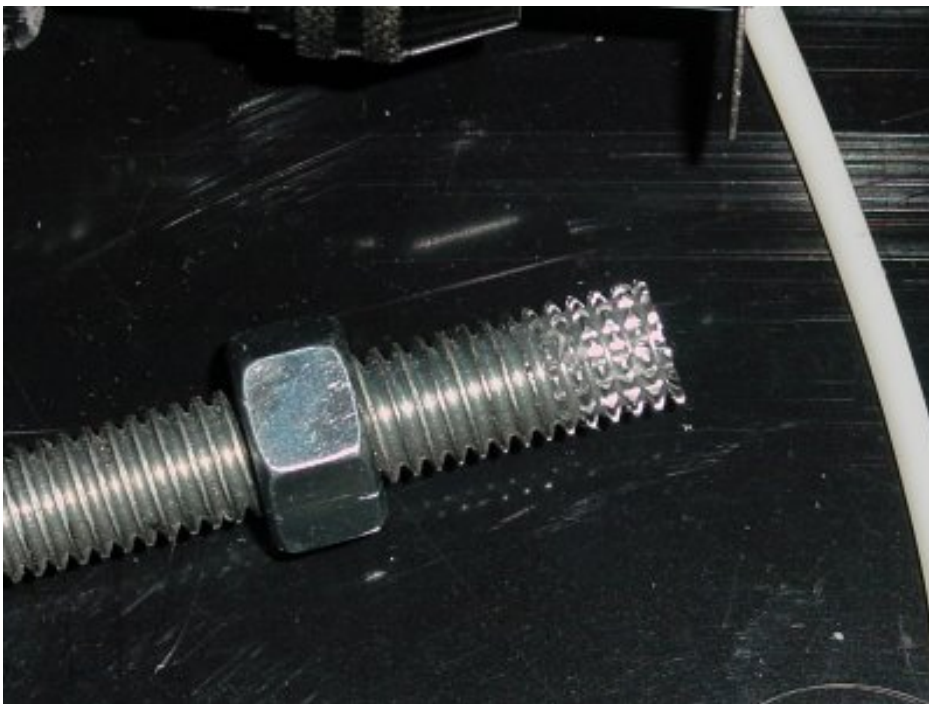

Just for fun, I tried using the diamond wheel on the threads of the stainless steel bolt and discovered that I could actually cut those pretty quickly.



That cut held the filament as well as the threaded rod cut. It then occurred to me that if I took advantage of the hex pocket in the bolt I could easily make a 3/8ths inch thick connector to connect the bolt to the GM-17 gearbox.



This humble little gripper was able to handle 10+ kg before the connector between the filament and the spring scale failed.



You see only 4 kg of load here. That's all I could manage holding the scale in one hand and the camera in the other.

The moment arm on the gripper is about 4.5 mm. Combine that with a 10 kg load and you see that you are looking at a torque of...

$$\text{torque} = (10 \text{ kg})(1000 \text{ gm/kg}) (4.5 \text{ mm})(.1 \text{ cm/mm}) = 4500 \text{ gm-cm} \sim 62.5 \text{ oz-in}$$

...which is about what a low end NEMA 23 or a high end NEMA 17 can deliver.

Now, if we leave the GM-17 hack gearbox at its original 228:1 and calculate torque assuming 150 gm-cm which is the holding torque for the Jameco tin can stepper

$$\text{torque} = (150 \text{ gm-cm})(228) = 34200 \text{ gm-cm} \sim 475 \text{ oz-in}$$

Figuring that a 3 mm filament has a cross-sectional area of about 7.1 mm² and a 0.5 mm filament about 0.2 mm², you can extrude 35.5 mm of 0.5 mm thread for every mm of filament consumed.

Thus you'd need about 1.4 mm of filament/sec to extrude at a rate of 50 mm/sec. To do that you need to be turning the gripper at about 3 rpm. We should be able to do that pretty easily without overheating the tin can stepper. I already know that I can get 5 rpm out of that hack at that gear

ratio, so I should be okay.

Fun Night at MakerBot

Monday, 18th May 2009 by Zach Smith

We've been really busy with MakerBot trying to keep up with orders and such, but sometimes we like to have fun too. Our friends Marius and Phillip from metalab in Austria are visiting for the month and they have been printing cool things ever since they got here.

Here's the video... you should definitely watch it because it's hilarious:

Accelerating RepRap

Tuesday, 26th May 2009 by Adrian Bowyer

[Accelerating RepRap](#) from [Adrian Bowyer](#) on [Vimeo](#).

The [experimental four-dimensional GCode interpreter](#) is now five-dimensional. Four dimensions are ~~so~~three weeks ago...

It has an extra DDA variable that is the feedrate. This means that if you send it:

```
G1 X85.3 Y75.8 E18.3 F2495.4
```

```
G1 X85.5 Y75.5 E18.7 F2575.9
```

For the second move it accelerates linearly from **2495.4**mm/minute to **2575.9**mm/minute as it moves from **X85.3 Y75.8 E18.3** to **X85.5 Y75.5 E18.7**. That is to say, it treats the **F** values in exactly the same way as it treats **X, Y, Z, and E**. (This is not how GCodes conventionally work, of course, so you can turn this behaviour off by commenting out a line in the firmware that says

```
#define ACCELERATION_ON
```

```
)
```

Of course you can have the machine move at constant speed as well if you want. You do that simply by setting the feedrate first:

```
G1 F2575.9
```

```
G1 X85.5 Y75.5 E18.7
```

That will do a move at a constant 2575.9 mm/minute, as you would expect.

The latest Java host software in the repository now supports all this (again you can turn it all off by setting **Accelerating false** in the preferences).

There is one final firmware upgrade needed to finish this work off: buffering the moves in the micro-controller (as Zach and co. are doing with their code). At the moment there is a barely-perceptible pause between moves, which means that accelerating to high speed hits a momentary barrier at the end of the acceleration. As the whole point of all this is to make the machine move much more smoothly, that's got to go.

Accelerations allow the machine to work faster and more accurately at much lower motor currents, or maybe even with smaller cheaper motors. Or *maybe* even with motors we print ourselves, which

Forrest is working towards...

I2C-based Reprap control

Tuesday, 26th May 2009 by Forrest Higgs

In which the control strategy for Tommelise 3.0 begins to emerge ... with implications for mainstream Arduino controllers...

I joined the Reprap project in 2006. At that time we were using Microchip 16F628A MCUs and the old SDCC open source compiler. I was Windows bound at the time and could never manage to get the cranky SDCC compiler to work on my system. I wanted to work with the firmware and finally acquired a cheap Serbian BASIC IDE for 16F family chips made by Oshonsoft that I could work with easily. From there I quickly migrated to the much more capable 16F877A and, when I discovered that stack space in the 16F family of MCUs was very limited, made the jump to 18Fs instead.

I began with the brilliant 18F4610 which I used to power Tommelise 1.0. I wanted to move over to USB comms from RS-232 and found the 18F4550 which had integral USB capability built-in when I began to build Tommelise 2.0 in 2008. By that time the mainstream of the Reprap project had moved over to the Arduino boards and the gcc C language compiler which they still use today. I was happy with what I had and stayed with Microchip processors.

About that time Reprap ran into a data transfer bottleneck. You could either transmit compressed control commands from your PC and have the MCU decode and expand them or you could send over less compressed data and buffer it. There has been a problem in that if you send compressed commands the decoding and expansion of them takes significant time which can cause pauses in printing operations. Given that extruders have a rather large lag time, that is not a good situation. The other option is to create a data buffer.

Most MCUs tend to be short of RAM memory. I took a rather heterodox approach to the problem. I decided that it would be nice if the PC could create pretty much completely decompressed data, viz, direct instructions to run steppers and extruders, and store them on a large buffer. The MCU would then only have to read the instructions off the buffer and execute them with no decoding to speak of.

I soon discovered that EEPROMS could be turned to this task. The 1 MegaBit 24FC1025 proved to be very well-suited to the task. You could address eight of them via an I2C bus from your MCU for a full megabyte of data buffering. While writing to them took a while you could read from them very quickly. I was able to build a half megabyte buffer with the 24F1025 which has proved very robust as a data buffer. Depending on the kind of milling or printing it is put to it can store anywhere up to 90 minutes worth of data.

The I2C bus proved to be a very useful way of organising things on a board. Before long I discovered the PCF8574 I2C slave chip. You could use one of these with virtually any chip made

and reduce the connection to your MCU to a pair of traces. Instead of boards which were mere's nests of traces you could group a slave chip with a particular chip and then hang the slave on the I2C bus.

A few months ago I demonstrated that the PCF 8574 could successfully control an SN754410 half-H stepper driver chip with no trouble whatsoever. That success led me to commit to using an I2C bus architecture for Tommelise 3.0.

It's all very well to talk about such things, but quite another to actually see the possibilities. In order to let you see what is possible, I've undertaken to document the architecture of what I know already works. I've reduced the architecture to a series of modules connected to an I2C bus for simplicity. In reality it matters little whether you create a bunch of little module boards or park all of the circuitry on a single board. Modular boards are simple and flexible while big boards tend to be better if you have a firm idea of what your system needs.

I'll begin showing you the system with a basic power conditioning circuit that dates back to the 16F628A days.

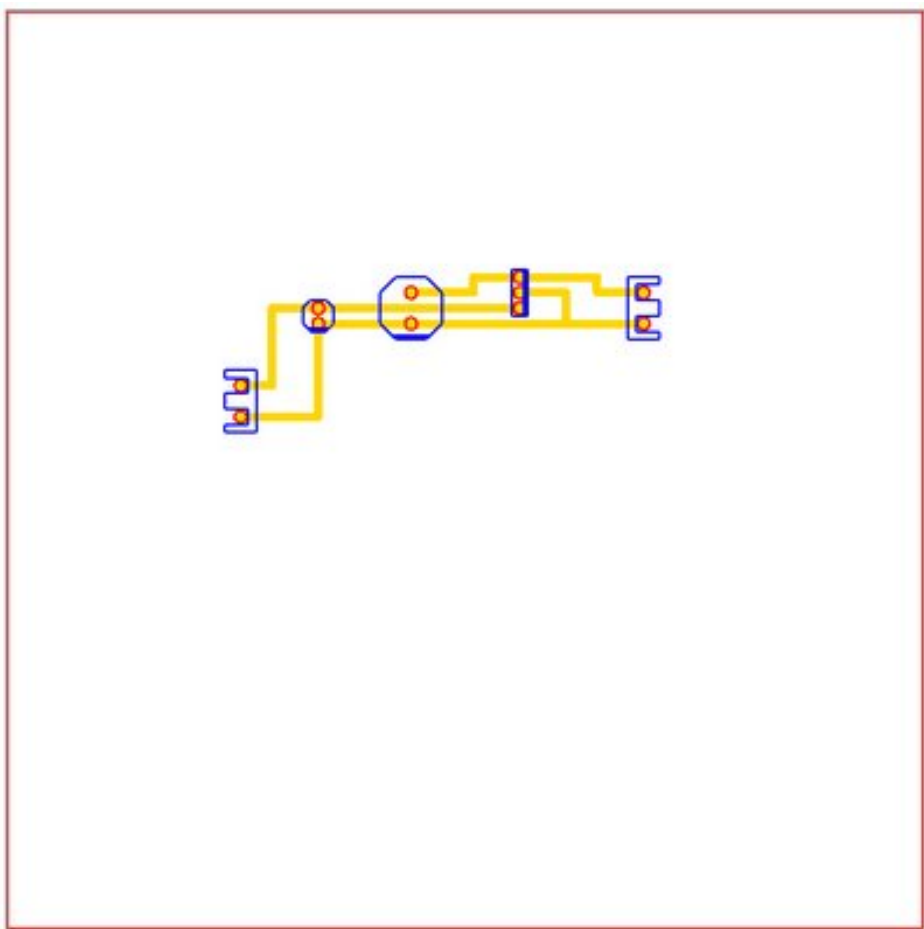

I've never found cause to change it because it simply works. You take in 12v DC power from an

ATX power unit that you can either buy or salvage from an old PC and put out +5v stabilised power for your Reprap. The circuit also has a nice big radial capacitor to smooth out any little wrinkles in your 12v power.

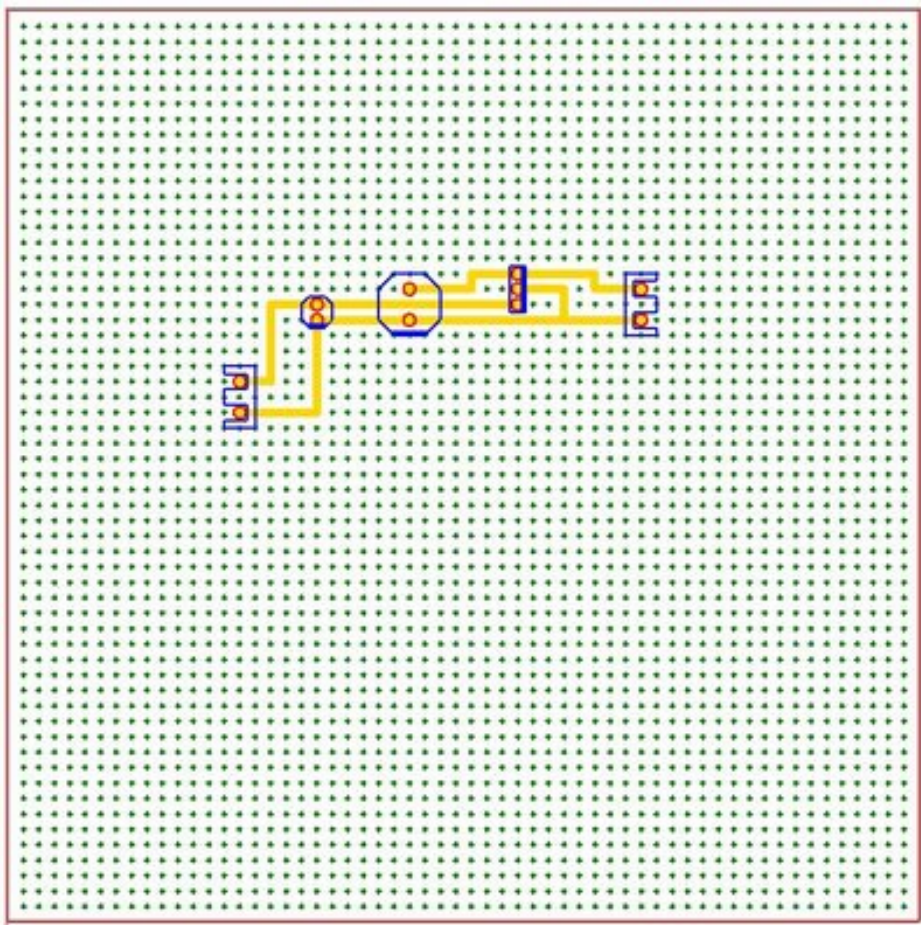

I've overlaid a standard 0.1 inch grid on the circuit so that you can get an idea of scale. Looking at just the components, you see them identified.

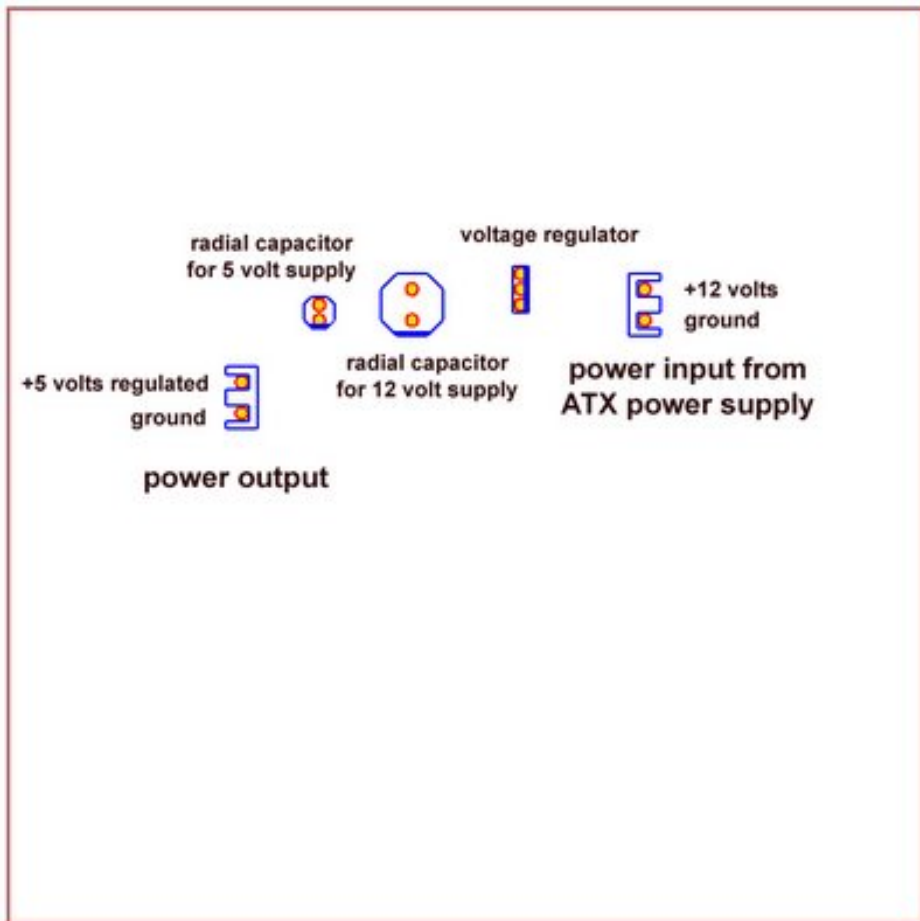

The blue stripe at the bottom of the capacitors corresponds to a stripe put on the capacitor cans which indicates which connector goes to ground. Get that backwards and you ruin the capacitor. Those connectors are standard 2-pole screw connectors that you can get from Radio Shack, Mouser or any of a hundred suppliers. There are cheaper and more task oriented connectors, but I've always liked connectors that I can just put a wire into without further ado.

Once you have power it is a simple matter to describe the MCU circuit.

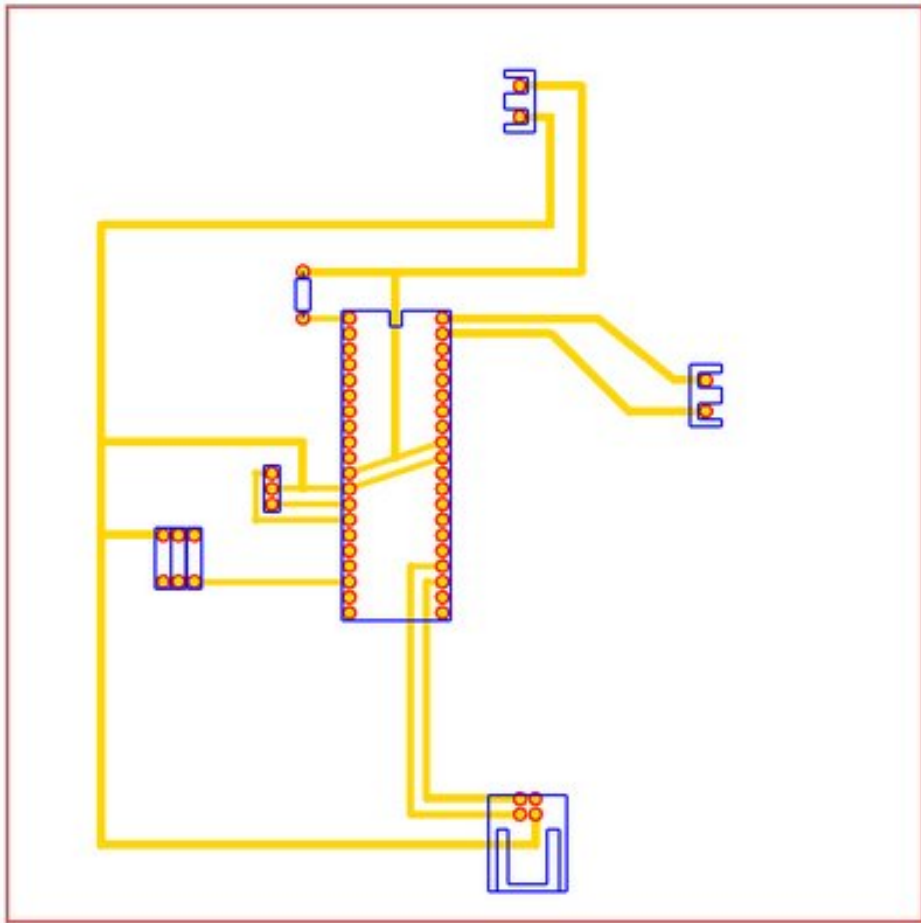

The Microchip 18F4550 is a 40 pin chip, rather big but not very expensive. Using the 4550 lets you dispense with silly RS-232 to USB chips and the whole mismatch between RS-232 as your PC understands it and RS-232 as your MCU understands it. You can see that there is just not a hell of a lot on this board. We also only use two port B pins (7 and 8) to drive the I2C bus. Nothing else is necessary. Looking at the components.

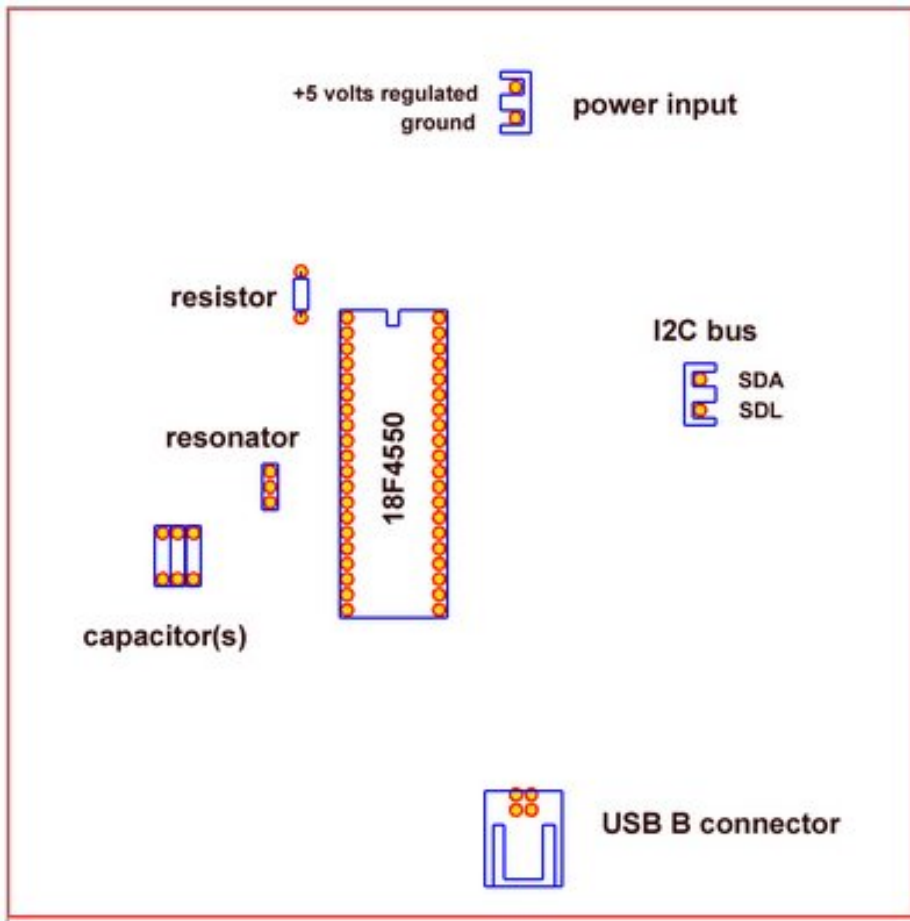

As you can see, there isn't much required on this board. There is a 10K ohm resistor between +5v and pin 1 on the 18F4550 and there are three (3) 104 nF disk capacitors that are required for the 3.3 v input to the USB power supply if you're not actually putting power into that pin. The MCU uses a 20 MHz resonator for clock timing. Aside from a couple of 2 pole connectors and the single USB type B connector, that's about it.

Here you can see the traces that connect everything. I plan on milling mine, but there is nothing to stop you from using stripboard or any of half a dozen other ways of connecting the components.

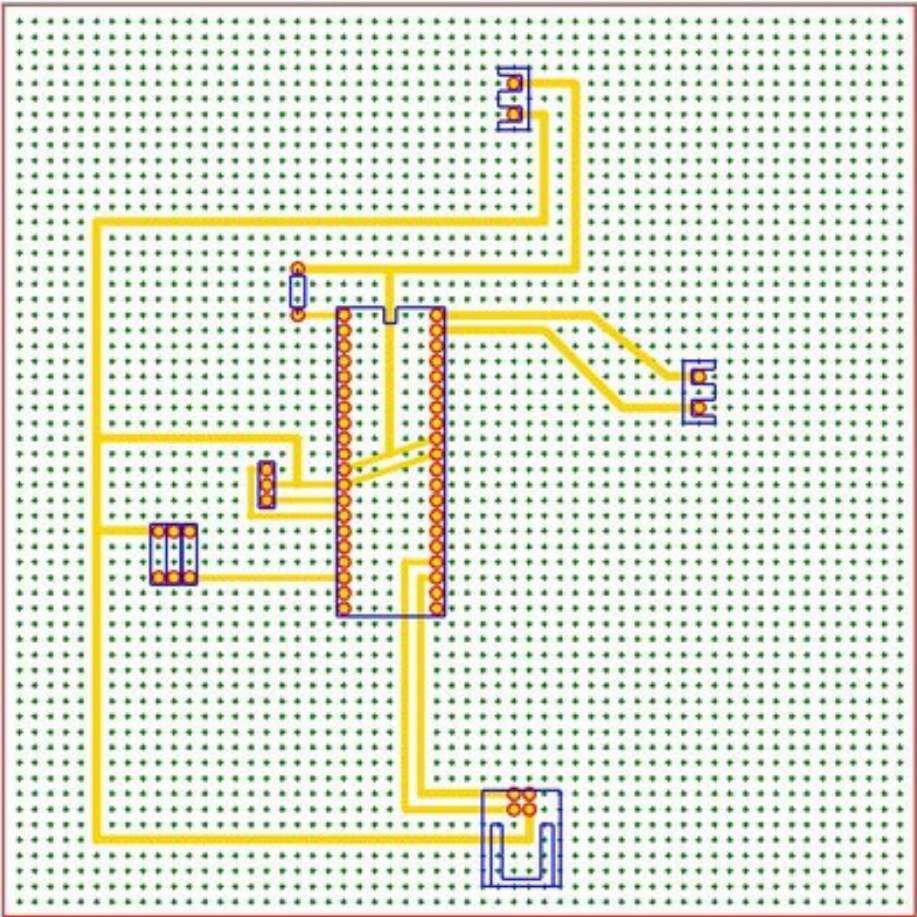

The EEPROM board is even simpler.

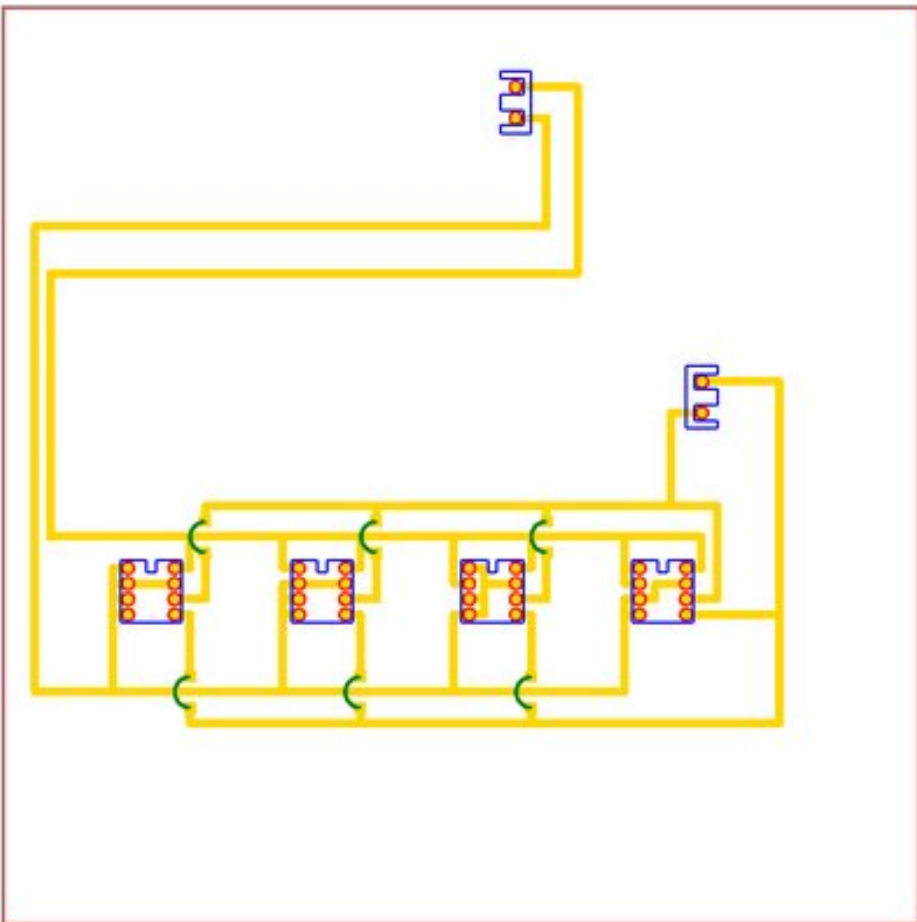

Those little green arcs are jumpers. I've designed the boards to be single sided, so jumpers are required from time to time. Not many, though.

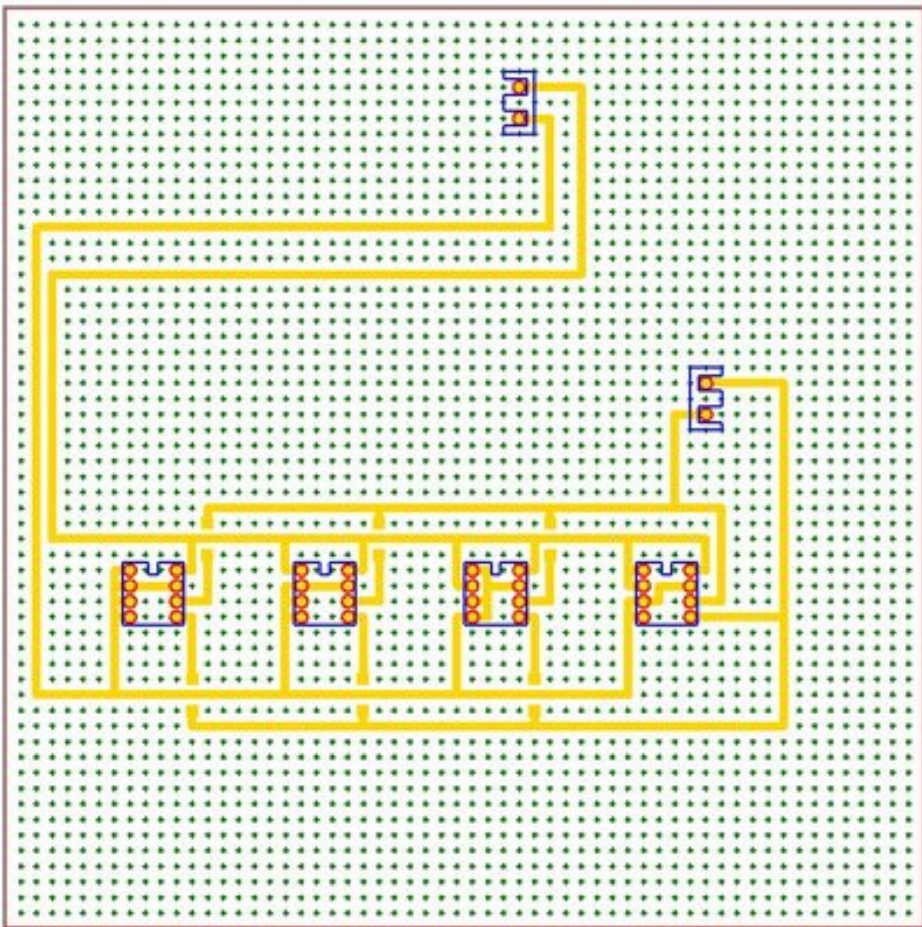

For components you've basically just got a few connectors, jumpers and the EEPROMs themselves. I've configured this board so that the EEPROMS fill 0-512 Kbytes. I could have made a single layout that you could use for both the bottom and top half of the megabyte that these EEPROMs will allow you, but that would have required four more jumpers which I felt would confuse matters for now.

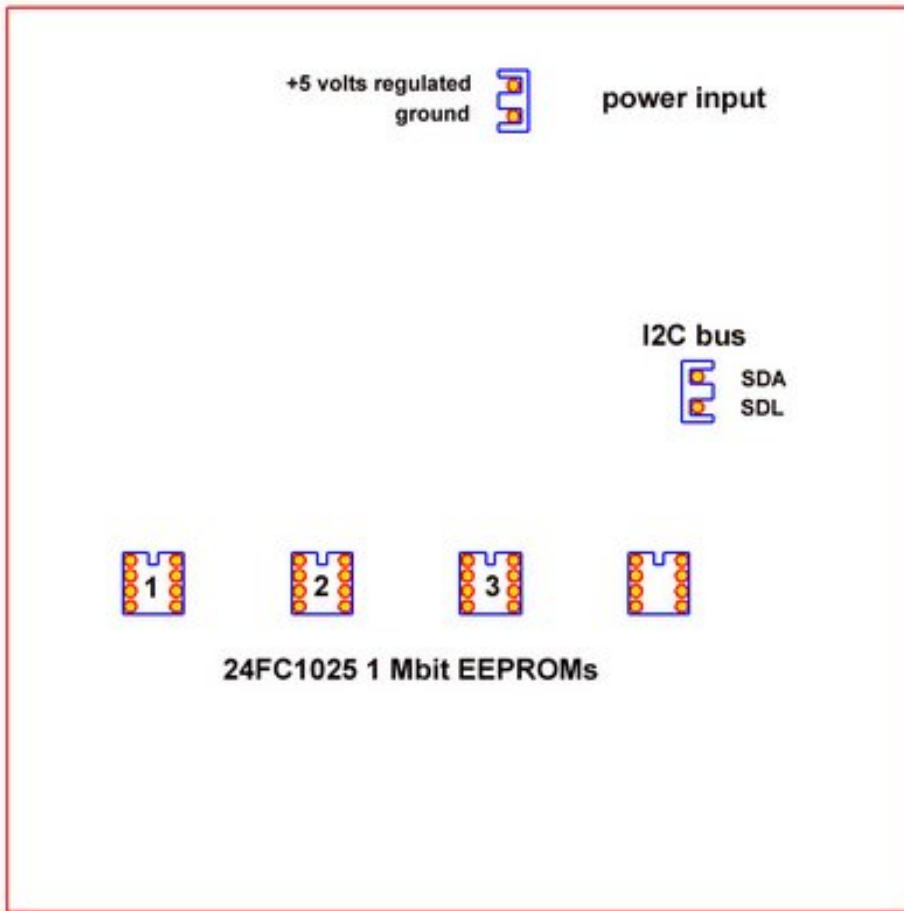

Moving on to the bipolar stepper controller board, you see that it is similarly rather trivial.

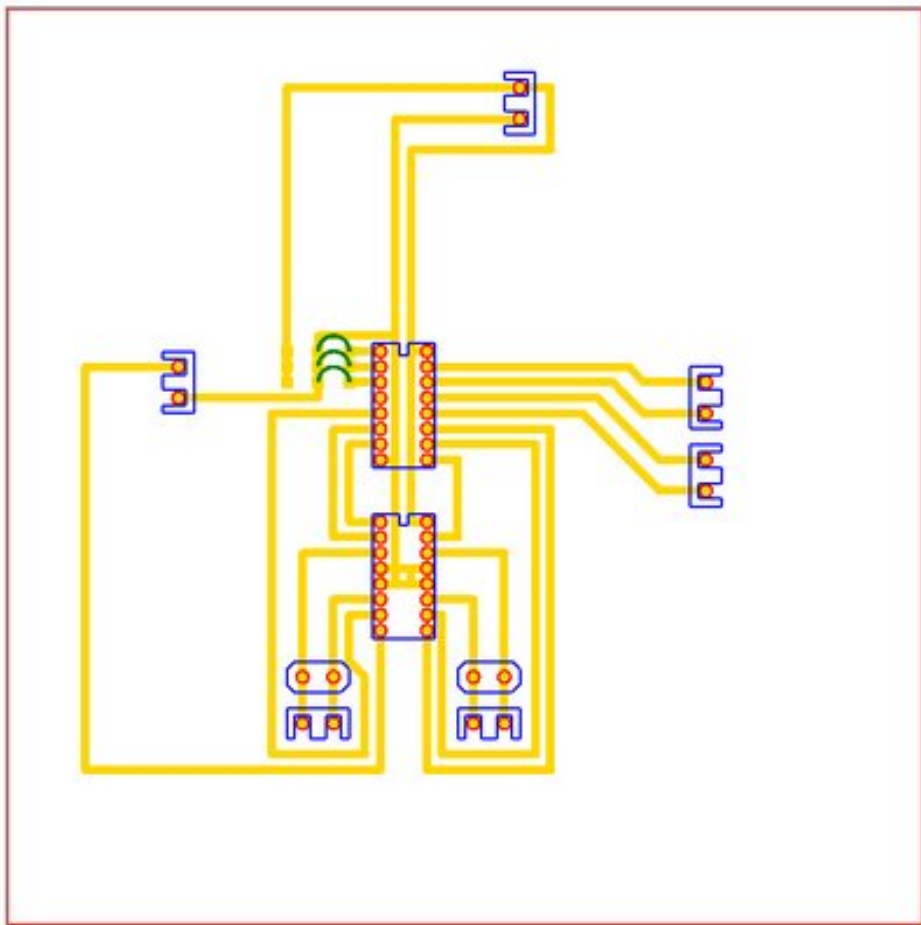

The three green jumpers on this board set the address for the I2C bus. You are going to want to control more than one stepper presumably, I couldn't just set the address to a single set of values.

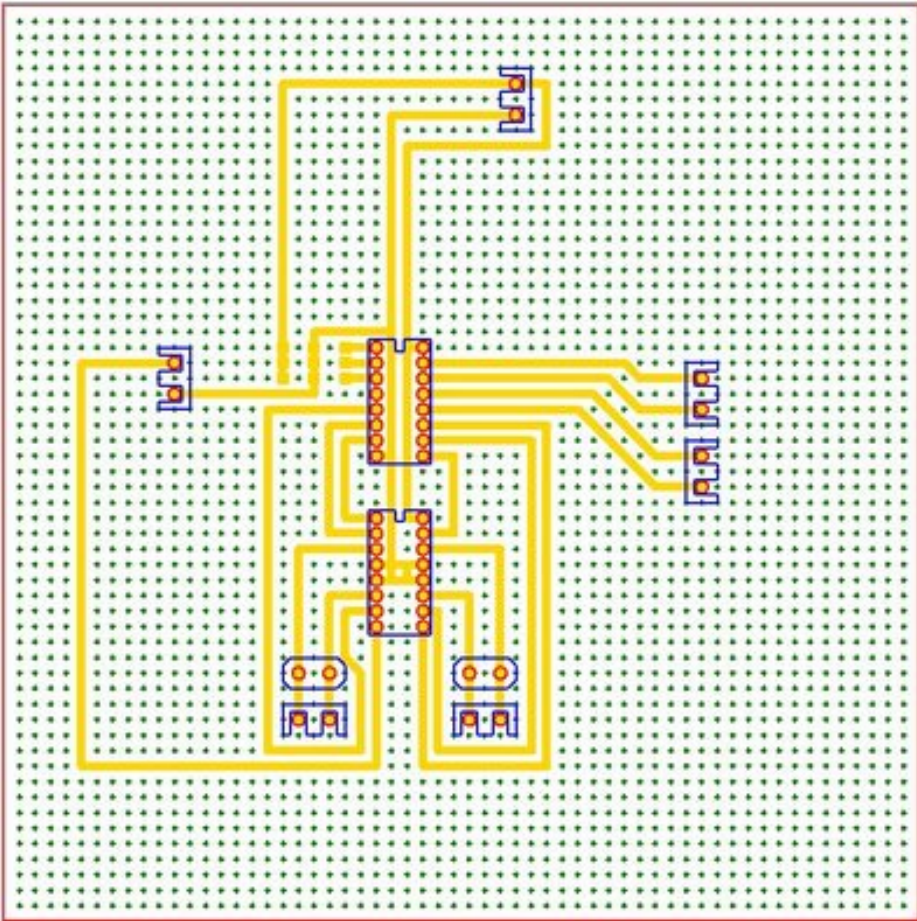

Components are similarly skimpy.

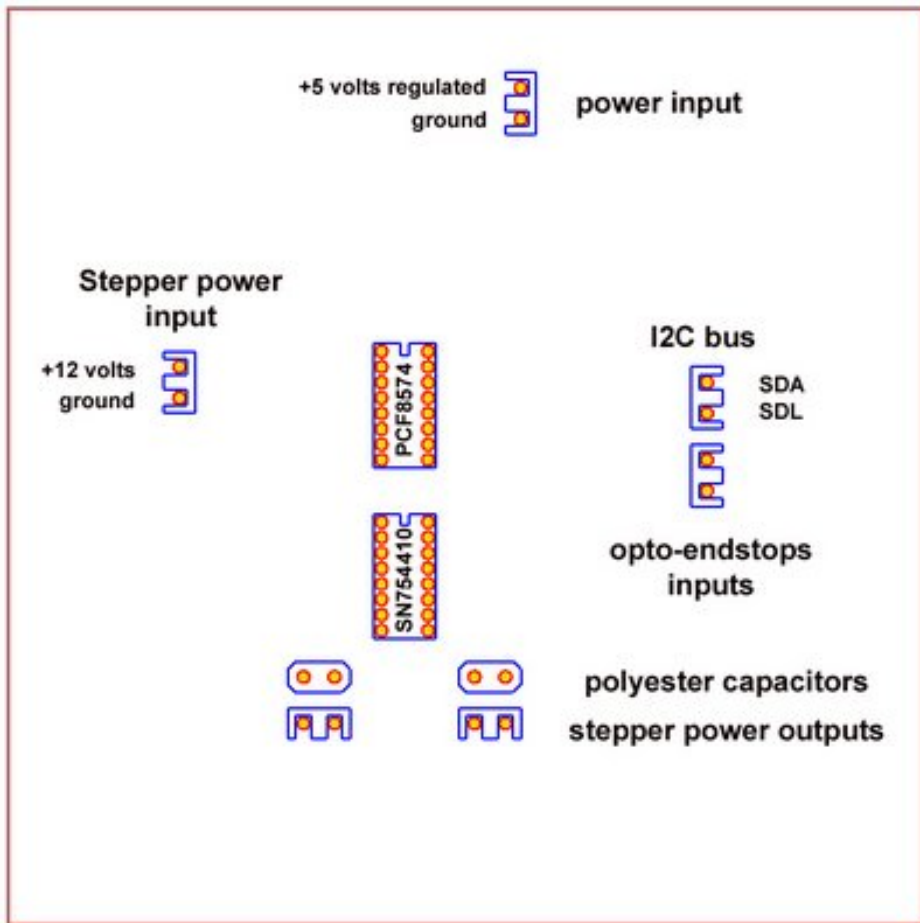

That's basically it, except for a slave MCU circuit that uses an MCF8574 and another, smaller Microchip MCU chip to look after the extruder. There will be a little pushing and shoving, but don't expect much in the way of complexity.

I already have a unipolar stepper controller board designed. I would have included it here, except that I haven't incorporated the extra diodes into it that Nophead says I need to make it really robust.

Any of the I2C slave boards could be incorporated into the Arduino/Sanguino system without a hiccup. There is nothing sacred about the Microchip MCU that I'm using. You could replace my 18F4550 with an equivalent Atmel chip and program it with gcc. About the only obstacle you'd run into would be that Atmel only offers an MCU with integral USB circuitry in surface mount technology. The 4550 is through-the-hole DIP technology, which, imo, is easier for people with more than two thumbs to work with. :-)

I'm committed to designing Reprap machines that can be pretty much built from the ground up by ordinary people. I think the current arrangement goes a long way toward making that possible.

Bowden extruder success!!

Monday, 1st June 2009 by eD

Wow. Finally. Four months ago I bet Adrian a Mars Bar that we could get this working, and now finally here it is €“ the Bowden extruder. By decoupling the motor from the carriage, we now have a ridiculously small extruder head. The implications of this with respect to machine design are wonderful: less dead space around the build volume leading to a more compact overall design, simpler carriage constraints, improved stability through elimination of moments and less energy required to move a lighter mass.

The key to this is a low-friction PTFE tube (a nod to Ian here for finding a supplier). Thanks to the archaic imperial system it is possible to get tube with an ID of 3.175 mm (1/8") to give a nice running fit for our 3.0mm PLA filament (this is one of the few times you will witness me thanking the imperial system).

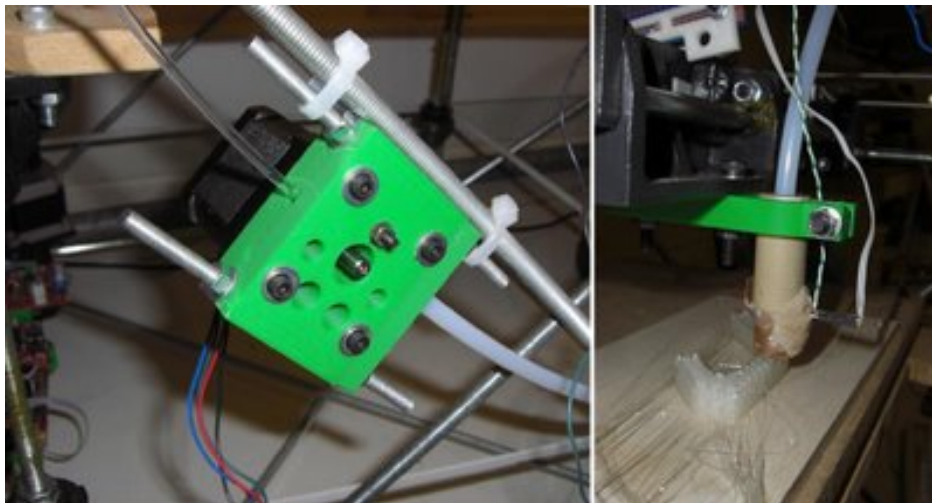

Of course hysteresis goes up as we increase the sprung length (our test used a 1 meter length to be sure). The result of this is a bit more stringy hair around the build - though Adrian's funky acceleration code is likely to be improving matters:



Once cleaned up, we were pleased to be unable to spot the difference between builds from the first pinch-wheel extruder (back, I think) and this Bowden extruder (front, I think).

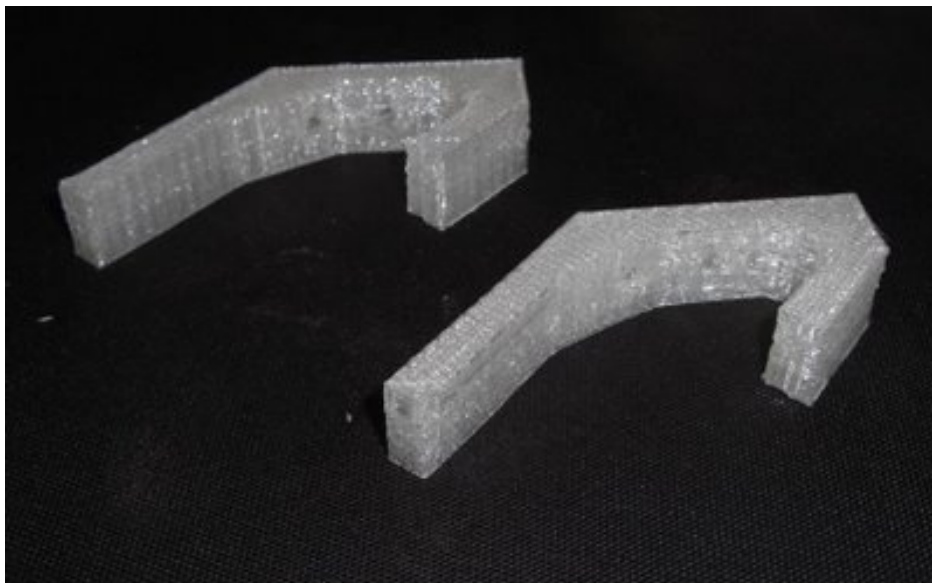

The PTFE tube can be super-glued into its respective housings (here ABS & PEEK) provided it is sufficiently roughed up with a file. I got my PTFE tube (1/8" ID, " OD) from [Adtech](#). I just rang Samantha there and she said if you mention the word 'RepRap' she might be able to sell you some without the minimum order charge.

Tommelise 3.0 I2C board finally built

Saturday, 6th June 2009 by Forrest Higgs

In which your narrator turns designs into hardware with remarkably little trouble...

Some time ago, I built up an I2C stepper controller board which can control two steppers to run my IR ranging scanner. This project allowed me to test out the viability of using I2C comms with I2C slave chips and to run open loop steppers with them. The board was pretty clean and very effective.

Rather than build a whole new board for Tommelise 3.0 I'm modifying that one and parking the third stepper controller and the eeprom memory buffer on a second board connected to the first by an I2C twisted pair. Here you can see the result.

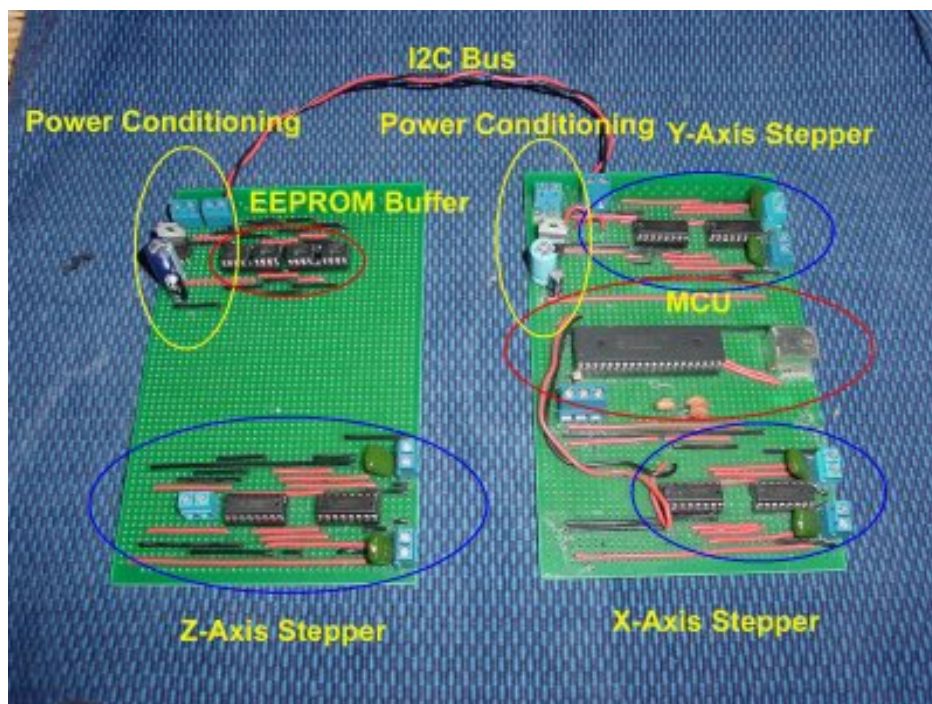

The IR scanner board is on the right and the extender board connected to it by the I2C bus is on the left. You can see that there is considerable real estate in the middle of the board left free. I might be able to park the extruder controller there, but if not, I just create another extender board.

I included the possibility of handling opto-endstops on the z-axis stepper controller. I need to add that in to the x and y-axis steppers on the old board. That is not a big thing to do.

The circuit diagrams shown in my previous blog entry, I2C-based Reprap control, are exactly what was used in the new board with one exception. The stepper controller circuit diagram that I posted had a small bug in it that I uncovered when I actually went to make the board. Here is the corrected circuit layout.

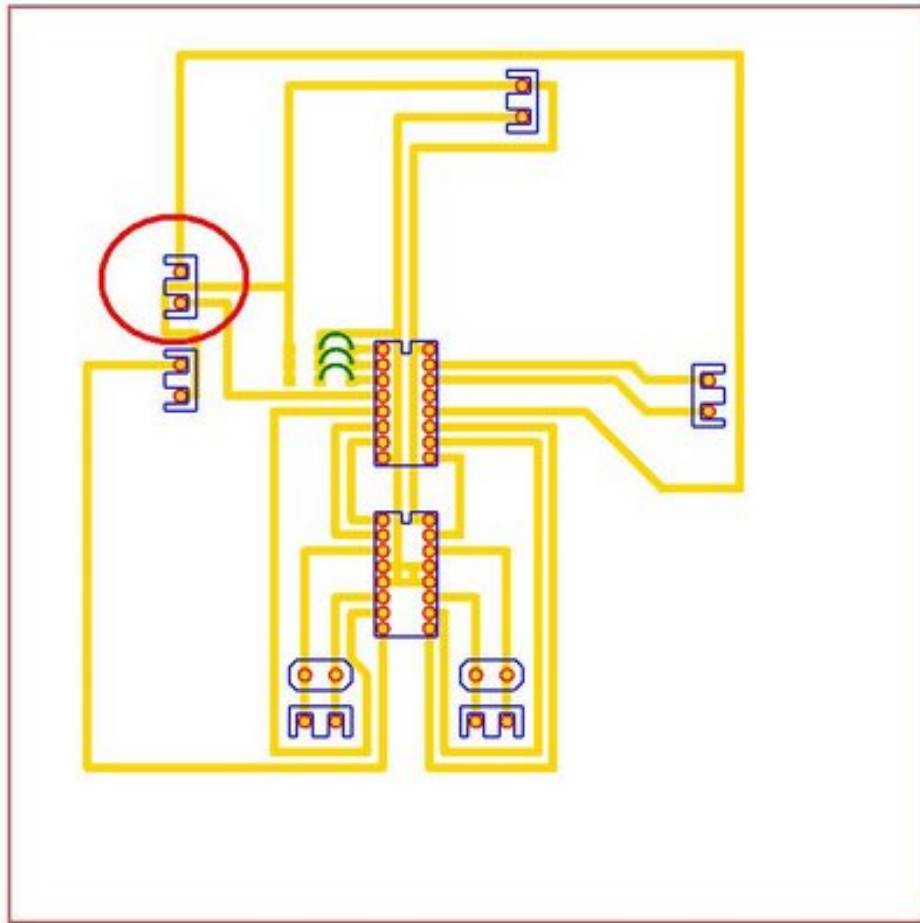

The two pole connector that was on the right hand side of the board has been moved to the left (circled in red) above the 12 volt power feed and a mistaken pin assignment corrected. There is room there for endstops at both ends of an axis, though I've never used more than one and that for resetting the start point of the axis.

The EEPROM buffer layout is a bit different in look from my earlier diagrams. This is a result of two factors. The first is that I'm using what is known as full-line Euro Card stripboard rather than milled, single sided printed circuit board. On a single sided pcb one tries very hard to minimize the number of jumpers. On stripboard, jumpers are the name of the game, which means that your board, though topologically identical looks very different.

As well, I used twin, 18 pin sockets to house the EEPROMs rather than four, 8 pin sockets. I had the 18 pin sockets and didn't have any 8 pin sockets.

The next step will be to test out the card to make sure everything works and then to rewrite Tommelise 2.0's firmware for the new bus architecture. Using I2C should considerably simplify the firmware. As well, I will be able to do half and full stepping with the new cards instead of merely wave stepping. That has already shown me that I can get a LOT more power out of my z-axis linear stepper. Heretofore, the lack of thrust in the z-axis has been a continuing headache for me in terms of the reliability of positioning in the z-axis. It appears that that will be a thing of the past with the new controller cards if the tests are any indicator.

RepRap wins at Bath University

Friday, 12th June 2009 by eD

It's not often one gets to spring up to a podium to collect a prize, and even rarer in merely Bermuda shorts and bare feet. However, this didn't put the judges from Bath University's post-graduate conference from giving the RepRap project first prize.



I didn't have to say much. When asked what was interesting about the project I said "It's going to change the world". She was taken aback a little, so I rammed it home: "Honest." I said. I was then asked to summarise the work in two sentences. I looked at the ceiling for a while. "Currently we ship consumer items from the other side of the planet because we do not have the ability to make things for ourselves. The RepRap project seeks to put manufacturing power into the hands of the people by delivering a manufacturing technology which can self-replicate."

(Poster was same from this [previous post](#))

Acceleration Code Released

Saturday, 13th June 2009 by Adrian Bowyer

There is a new release of the Java host software and the Sanguino firmware that support accelerations and decelerations during building.

Accelerating RepRap from Adrian Bowyer on Vimeo.

Unfortunately the new firmware is now too big to fit in the Arduino ATMEGA 168 controllers (though the old version that does is still available, of course). However, there is plenty of room in the Sanguino, and we will be supporting the Arduino Mega as a RepRap controller soon.

The new firmware buffers all movements, and so communications with the controller are now asynchronous. This completely eliminates all pauses between one movement and the next.

The main advantage of the new code is that you can run the axis motors at much lower current (as they don't have to hit the feed-rate requested in one step from a standing start) while not compromising build times; indeed, you can set higher maximum feed-rates as the machine now accelerates up to them and decelerates down.

Sourceforge awards

Wednesday, 17th June 2009 by Adrian Bowyer

RepRap has made it to the finals of the SourceForge.net Community Choice Awards in the "Most Likely to Change the Way You Do Everything" category, so, firstly and most importantly, a big thanks to all of you who voted for the project :-)

We've done a video on RepRap for the finals, and we think it makes a good general introduction to the project too.

RepRap from Adrian Bowyer on Vimeo.

So now, when your friends who don't know the difference between the Java heap and an H bridge ask what it's all about, you can point them at that and go back to your beer...

SourceForge Community Choice Awards

Wednesday, 24th June 2009 by Adrian Bowyer

-

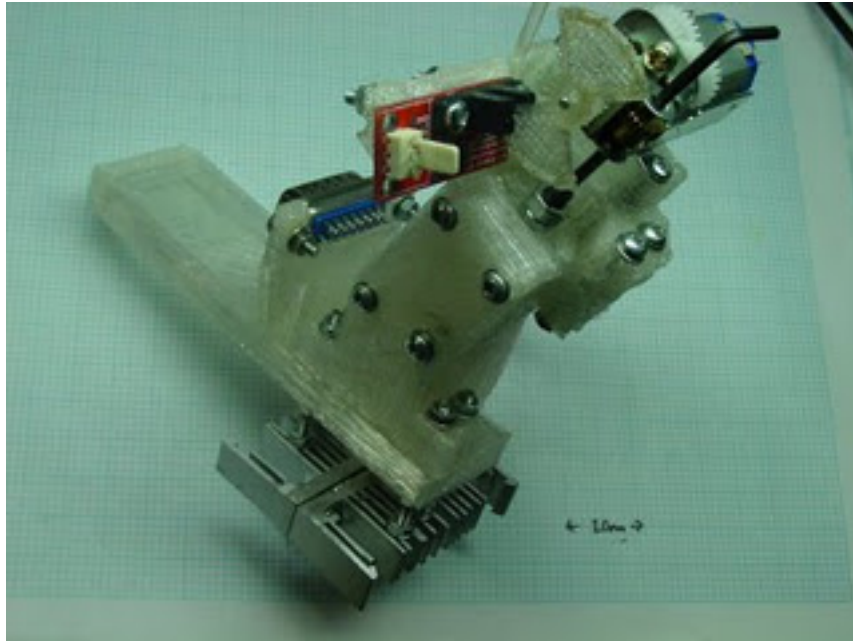

Image not found.

Voting among the finalists has started! If you'd like RepRap to win the "Project most likely to change the way we do everything" category, click on the link/image above, and - of course - tell all your friends :-)

Tamiya Universal Extruder

Sunday, 28th June 2009 by Vik Olliver



Here's a shot of the extruder designed to use the Tamiya Universal Gearbox, no lathing required. The Tamiya shaft is replaced with a 2.5mm hex key, and that fits into an M5 grub-screw locknuted on to the top of the M5 extruder drive. There is a crude thrust bearing (locknuts & washers) inside, and half a drilled M5 nut to support the drive screw where the filament presses against it. It's mechanically complete but needs wiring up with a working opto board and a thermocouple - which are in the post. Yes, I know I'll have to paint the opto vanes or stick tape on them.

So Simon, here's your new extruder :) Actually I'll tidy up the models a bit and run you off a fresh one. The modelling has been done in BRL-CAD, exported with g-stl to STL format, then repositioned with ArtOfIllusion, saved as an STL again, converted to g-code by skeinforge and then sent to the Gcode RepRap "Phoenix" by the Java GUI program. It's a convoluted path but I kept on having snags at every darned step!

With the exception of the opto-board, all the pieces were sourced in New Zealand (which bodes well for other places). One day, I'd like to stick this on an I2C control bus so everything can be controlled from an Arduino without running out of pins!

It can take either a 16mm PTFE extruder barrel or the no-lathe heatsink one as shown. The clamp fixture is compatible with Darwin interchangeable extruder holders - I checked :) I'll post the files after their final tidying.

Vik :v)

Stepper driver for Extruder Controller V2.2

Wednesday, 1st July 2009 by Adrian Bowyer

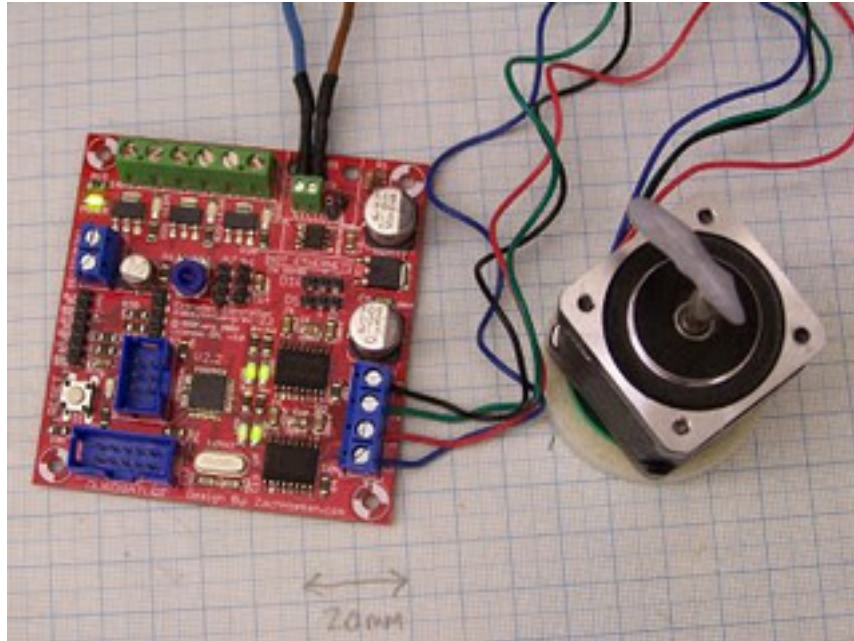

Zach's new extruder controller was first used to control DC-motor extruders, as used in the MakerBot Cupcake (and also older versions of RepRap). But it is also capable of driving a stepper, which will allow it to be used with the new RepRap extruder too.

You can find details on the Builder's Wiki [here](#).

No-lathe extruder interior

Thursday, 2nd July 2009 by Vik Olliver



Some were a little puzzled as to how the interior of the no-lathe extruder works. As I'm putting a few together, I took a photo showing how it combines the ideas of a simple locknut thrust bearing and a chopped-up drilled nut being used as the bearing behind the filament contact point. Files now online at <http://www.thingiverse.com/thing:765>.

Vik :v)

RepRap Main Website Outage - Updated

Thursday, 9th July 2009 by Vik Olliver

Looks like we're up again, but the changes may take some time to filter through the interwebs so I'll leave the original alert in place.

---8<-----8<-----8<-----8<-----8<-----8<-----8<-----8<-----8<-----

For reasons unproven, our web server has keeled over. Brave technical wizards are hard at work pumping backups through the thin tubes of the international internet. Resurrection will be attempted. Meanwhile:

<http://203.96.60.151> contains a temporary old site.

The pages everyone on reddit is trying to look at are cached here (sadly without pictures and frame formatting like there is on the site link above):

Google Cache: http://74.125.93.132/search?q=cache:_vO1qm-t8PsJ:reprap.org/+reprap&cd=1&hl=en&ct=clnk&gl=us&client=firefox-a

And the video is on on vimeo here: <http://vimeo.com/5202148>

The voting page for the Sourceforge Community Choice Award is:

<https://sourceforge.net/community/cca09/vote>

There is also an IRC #reprap channel on freenode.net

Vik :v)

Stripboard Design App

Saturday, 11th July 2009 by Forrest Higgs

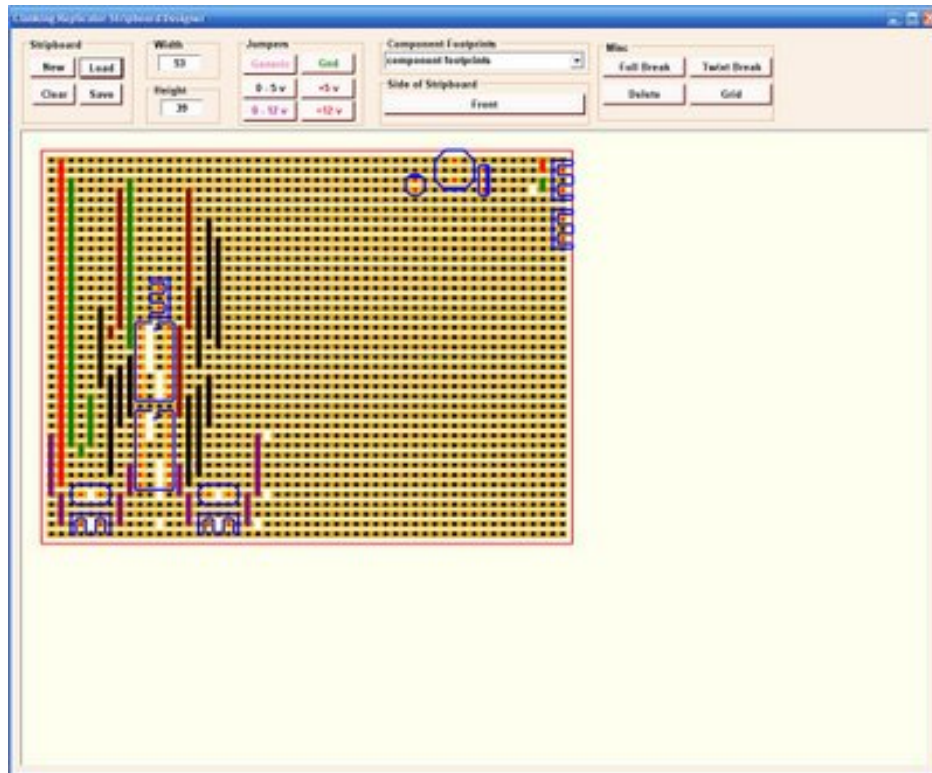

I've finally finished a Windows app for stripboard design. If you want to play with it you can read about it and download it [here](#) . Have fun! :-D

High-rise RepRaps

Saturday, 18th July 2009 by Vik Olliver

I had a daft idea the other day: It started off with a double-decker RepRap, and ended up with a vision of RepRaps in a 19" rack frame. The RepRap below was building the RepRap above...

In theory, RepRaps should work upside-down or even in zero gravity. The extrusion is forced out in contact so doesn't need to fall anywhere. So, time to get 2 Darwins running simultaneously in the workshop and then get creative with some 2x4. Anyone near Auckland with an unused 19" rack who really likes RepRaps?

Vik :v)

[No Title]

Sunday, 19th July 2009 by Zach Smith

After a long wait, ReplicatorG 0005 is finally available for your printing and simulating enjoyment. Most of the changes have been stability fixes and tinkering under the hood, but there's also a bunch of changes that should make your life a bit easier (especially if you were using 0004):

- * ReplicatorG is now much smarter about serial ports. When you select a machine type that uses a serial port, it will automatically scan all available serial ports to try to detect a working machine.
- * You can now explicitly tell ReplicatorG which serial port to use. There's a "Serial Port" submenu in the "Machine" menu that allows you to select any available port. If you forgot to plug in your serial cable when you started ReplicatorG, you can just select "rescan serial ports" after you plug it in and the port should appear in the list.
- * You can now run multiple instances of ReplicatorG on the same machine and have them connect to different serial ports. This means you can now run several 3D printers simultaneously from the same computer! (Pretty handy if you have to, say, print out three dozen pulleys in a hurry.)
- * There's been a little bit of consolidation of the status displays; we're down to just two separate status bars on the main window now. :)
- * The "stop" and "pause/unpause" functionality is now more reliable. However, a word of caution: a stop or pause is not guaranteed to halt the extruder as well; a fix for this will be in the next firmware update.
- * There should be far fewer situations where the program blocks; for example, you should be able to exit normally after hitting the reset button on the machine.

You can download ReplicatorG 0005 from [googlecode](#).

Be sure to leave a comment and let me know how 0005 works out for you, and let me know about any changes you'd like to see in 0006.

via the [MakerBot Blog](#)

Dancing shoes

Sunday, 19th July 2009 by Adrian Bowyer

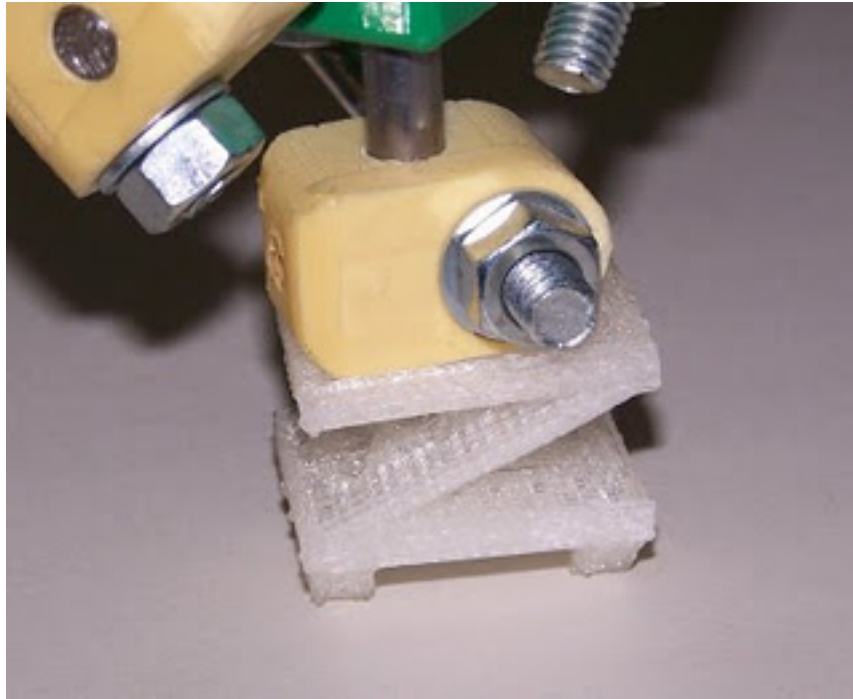

If you run your RepRap on a resonant surface such as a table, you may notice a strange thumping noise. That noise is your neighbours in the flat below banging on their ceiling with a broom-handle.

There are two solutions to this:

1. You can make four of these, or
2. You can murder your neighbours, dismember them, and distribute their remains in sealed plastic bags round the wastebins of the nearest large city.

The first option is the recommended one.

These spring feet decouple the mass of the RepRap machine from whatever it is resting on. That considerably reduces the transmission of the vibrations from the machine.

Details and file downloads are [here on Thingiverse](#).

RepStrapping Open Source Ecology

Monday, 20th July 2009 by nophead

Back in March I had a visit from Marcin Jakubowski, the founder of Open Source Ecology. He was over here in Manchester presenting at a conference and asked if he could come and see HydraRaptor, as he wants to use RepRap machines on Factor e Farm. Like RepRap, his project also aims to change the world.

He asked lots of questions and made a couple of videos of my answers for his blog, which you can see here.

I volunteered to print a set of Darwin parts to help get Factor e Farm up and running with 3D printing. I was confident that I would have my Darwin running in time to churn out the parts. However, because I spent a lot of time experimenting with extruder designs in an attempt to get something more reliable, I ran out of time and had to print the parts on HydraRaptor.

Here they are, all 109 of them: -



More details here: hydraraptor.blogspot.com/2009/07/hydraraptors-second-child.

The Cable Tie Track Trick

Monday, 20th July 2009 by Vik Olliver



I had another nutty idea all of a sudden. Would cable ties work as a precision track? So I rolled a very funny-looking gear by hand and found it might. I put a section of it in the jig we use for making Darwin gears, and it came out a little strange but definitely worked.

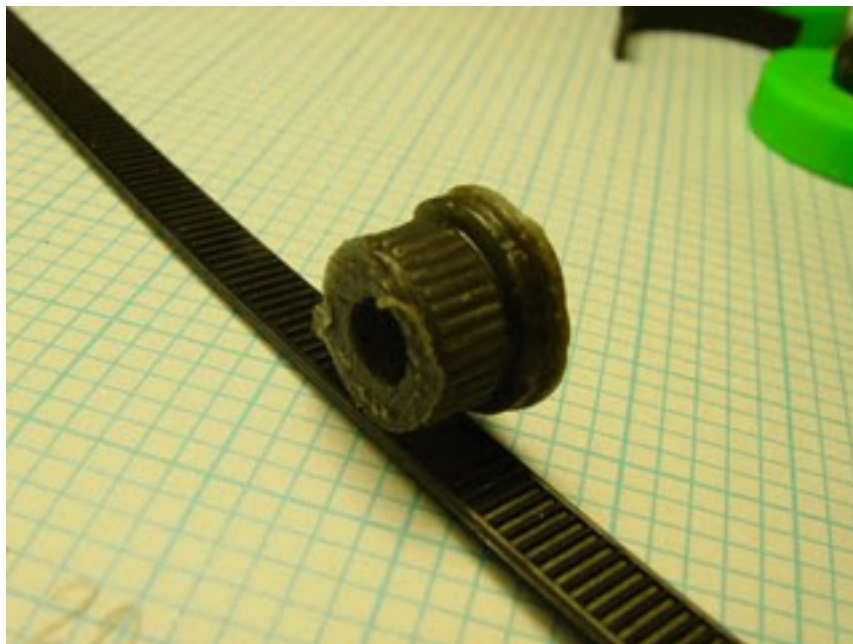

As you can see, I didn't break the jig or anything - the polymorph (yes, I dyed it black with candle soot) was just a little too cold. Stabbing it with the wrong size screwdriver for a shaft didn't help either. However, it is getting late and I must away. And soe once more to bedde...

Vik :v)

Build Quality

Sunday, 26th July 2009 by Adrian Bowyer

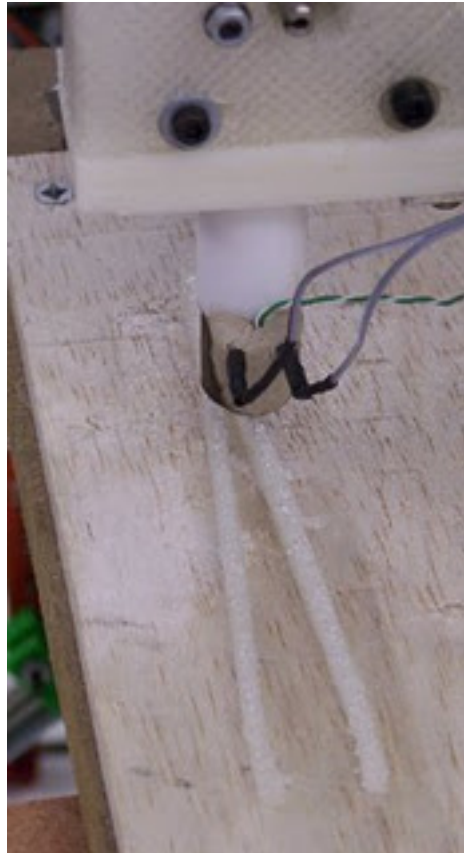

This is not a new idea (indeed, it's so old that I've forgotten if it was Simon or Nophead who first suggested it; apologies to the true originator if it was neither of them...). But a simple way to improve build quality is to start and end the outlines of parts from within the solid area that they surround. This avoids dwell problems at the start and finish of the outline, and wipes the nozzle on the interior of the part itself as the head moves off to the next outline. All the slightly dodgy blobs, dribbles and so on are left buried in the fill, and don't appear on the outer surface.

At the end of last week Ed and I realised that a simple way to do this is to use the hatch that fills the interior as a guide to what is needed. I've now implemented this in the Java Host software and checked it into the repository. On the right is the new code building my handy SMT-measuring tweezers. This type of object with its thin sections is notorious for generating lots of spurious bumps and string. As you can see there is the occasional lump (easily removed with a fingernail post build), but the quality is much better than before. And it works even better on chunky things like the coat hook.

The way the code works is to identify the extremal corner of the profile in the hatch direction. It then finds the nearest point in the hatch to that. From that hatch point it tracks through the hatch until it finds a reasonably long hatch line (where "reasonably long" == 10 mm or so). It then adds

the hatch lines from the middle of that long segment to the outline polygon and deletes them from the hatch. There are other heuristics to deal with cases where it can't find a long bit and similar problems.

The effect of this is to start the outline within the solid (and the middle of a "reasonably long" hatch line is likely to be a sensible distance from the perimeter for that start), run to the outer edge having left dwell blobs and draggy starts in the middle of the solid, run neatly round the outline, and then move back into the middle again (without extruding) to finish.

It's always nice when you can make things better just by changing the software...

I'll play with it for a bit to check it works OK, then do a release.

The RepRap Clock

Tuesday, 28th July 2009 by Adrian Bowyer

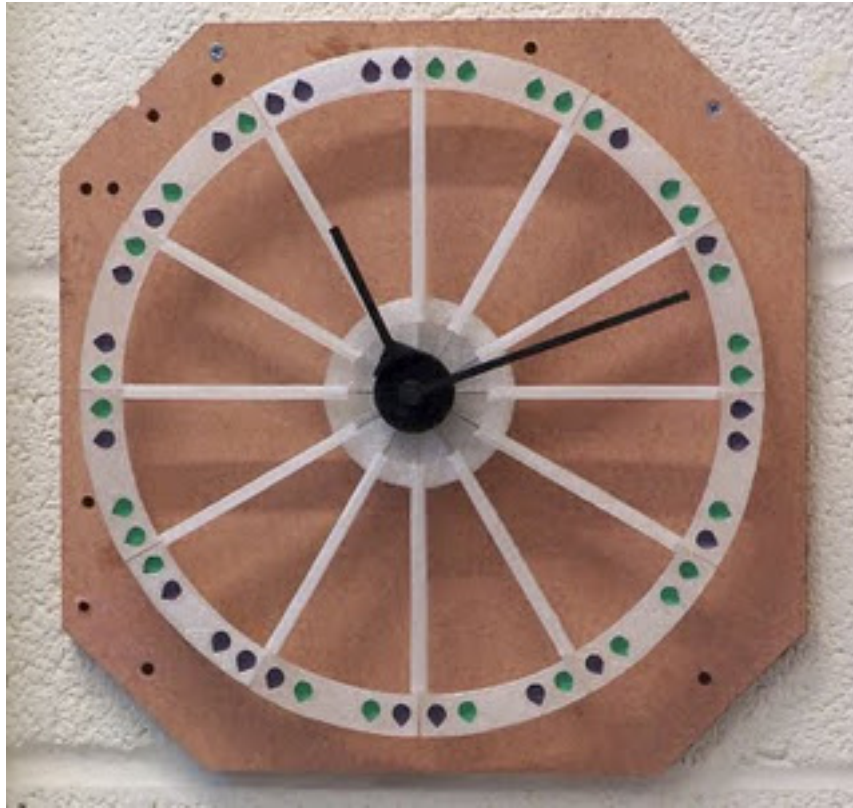

We needed a clock in the RepRap Lab at Bath University. So, of course, we made one.

It's shown mounted on the MDF build platform from ARNIE - the very first prototype RepRap that we made. See RepRap history at:

blog.reprap.org/2007/02/arnie-gives-it-shot.html

Naturally the hours are in binary...

Full build details and all files are [here on Thingiverse](#).

Battle of The Bulge pt2

Saturday, 1st August 2009 by Vik Olliver



For those interested, here's what can happen when you use 10mm PTFE rod for your extruder insulator with plastics that melt at a higher temperature than the original CAPA. This image shows a 3mm PLA filament extracted after a jam - the PTFE insulator is now useless. The ridges on the right are from where the thread of the screw drive forces the filament in. You can see that it fades out towards the centre indicating that at this point in the PTFE, the filament is just becoming plastic enough to conform to the walls. Only the cloudy last 6mm of the rod on the left were in the heater barrel itself, and they are only cloudy because I stress-fractured the rod at that point to get it out.

Diagram showing how PTFE bulges when overheated

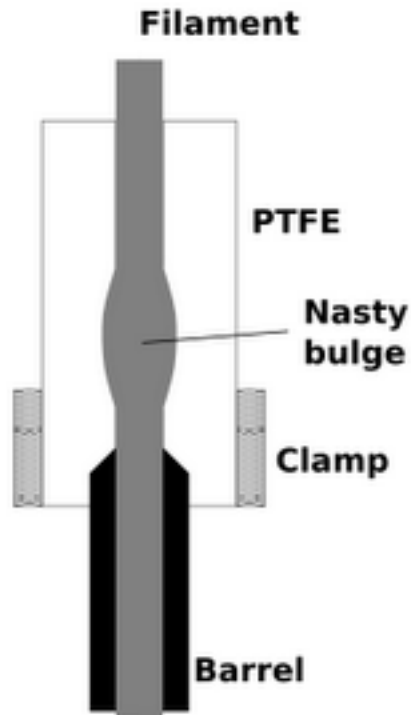

You can clearly see that a significant bulge is forming in the PTFE shortly before this, expanding the filament to nearly 4mm diameter. The PLA has very little plasticity at this point and so effectively plugs itself into any developing bulge and forces it open wider. This is why the PTFE barrel is now scrap, and may explain why some users are finding that their extruder has inexplicably developed a tendency to jam solid. This extruder had always been operated with a tight hose-clamp over the join between the PTFE insulator and the heater barrel proper.

I'm reaming out the extruder clamp/base to 16mm to take the recommended, stouter PTFE insulator that I machined up on the old new lathe (or is that new old lathe) at the Wellington MakerSpace last week. The insulator's in the suitcase somewhere...

Vik :v)

RepRap, the book

Monday, 3rd August 2009 by eD

Well, as many of you may know my PhD was on the mechanical considerations for Darwin (the first release of the RepRap printer). I graduated recently and have finally submitted my thesis. I've uploaded a pdf to

<http://www.reprap.org/bin/view/Main/DocumentationMain>

under the 'Machines' heading.



Please ignore the copywrite statement, this was necessary to get it submitted under university rules on time, and is in a long drawn out process of being waived.

[No Title]

Thursday, 6th August 2009 by Zach Smith

One of my partners at MakerBot, Adam Mayer has been working non-stop on improving the firmware used to drive the 3rd generation electronics for both RepRap and MakerBot machines. New version was released yesterday:

Hey, intrepid Makerbotters! The v1.2 release of the generation 3 firmware is now available on SourceForge. This release features bugfixes and enhancements to the firmware on the both the motherboard and the extruder. You can download it here. Be sure to check the Readme.txt for installation hints! The changelog is after the cut.

There are small updates to both the firmware on the motherboard and the extruder controller. Some of the changes€“ like the eeprom configuration stuff€“ won't be useful until ReplicatorG 0006 comes out in a day or so, but if you're willing to experiment, I encourage folks to try out the new version, and file lots of bug reports. :)

Changes from v1.1:

- * Readme.txt and Changelog.txt introduced.
- * Introduction of circular buffer cursors, allowing us to easily abort processing of a command.
- * Reduced blocking waits, reducing the chance of build burps.
- * Added support for storing per-machine configuration data in the EEPROM.
- * Support for inverting individual axes via EEPROM configuration bits.
- * Better support for aborting and pausing builds.
- * Stops extruder on abort.

Good luck!

(via [MakerBot Blog](#))

ReplicatorG 0006 Available

Friday, 7th August 2009 by Zach Smith

ReplicatorG 0006 is now available for your replicating pleasure! (Well, if you're using Linux or Windows. Mac OS X users, you'll have to wait until I get to do a Mac build in the morning.) This release should make life a little easier for those of you who have been having serial port configuration issues. Other fun enhancements include:

- * Per-axis motor inversion (requires v1.2 firmware)
- * More reliable build aborts
- * An optional in-build temperature readout (disabled by default, but can be turned on in the preferences)

[Download it here!](#) A more detailed changelog follows after the cut.

0006 changelog:

- * Removed editor status bar
- * 64-bit Mac OS X fix (courtesy Andreas Fuchs)
- * Pass a GCode file in as a command-line parameter (courtesy Andreas Fuchs)
- * Moved machine status below buttons and cleaned up display
- * Ensure abort signal is sent to S3G on stop
- * Display temperature of nozzle during builds (disabled by default)
- * Add pref for temperature display
- * Simulator2D optimizations, faster draws
- * Reenabled Ctrl-J shortcut for control panel
- * Use port names specified in XML by default, fall back to autoscan if not present
- * Allow autoscan disabling for machines with scan problems
- * Added support for writing onboard configuration data to the machine EEPROM
- * Numerous small bug fixes
- * New skeinforge version
- * Larger max heap size on Mac OS X

A brief word on the new serial port selection routine: if you explicitly define the "portname" tag in your machines.xml, ReplicatorG will attempt to connect to that port immediately. Otherwise, it will by default autoscan your serial ports to find a working machine. If you want to manually select your serial port (say, because ReplicatorG is hanging while trying to scan one of your other serial ports) you can turn the autoscan function off by unchecking it in the "Machines > Serial" menu.

Autoscan also no longer tries to scan ports in alphabetical order; it now scans them in the same order RXTX presents them. This is closer to the behavior of older versions of ReplicatorG, and

should end up scanning USB-TTY cables earlier in the process.

Have fun, and as always drop me a line or post here with any problems and I'll do my best to fix them quickly.

(via the [MakerBot Blog](#))

Slicing and dicing with image processing

Sunday, 9th August 2009 by Forrest Higgs

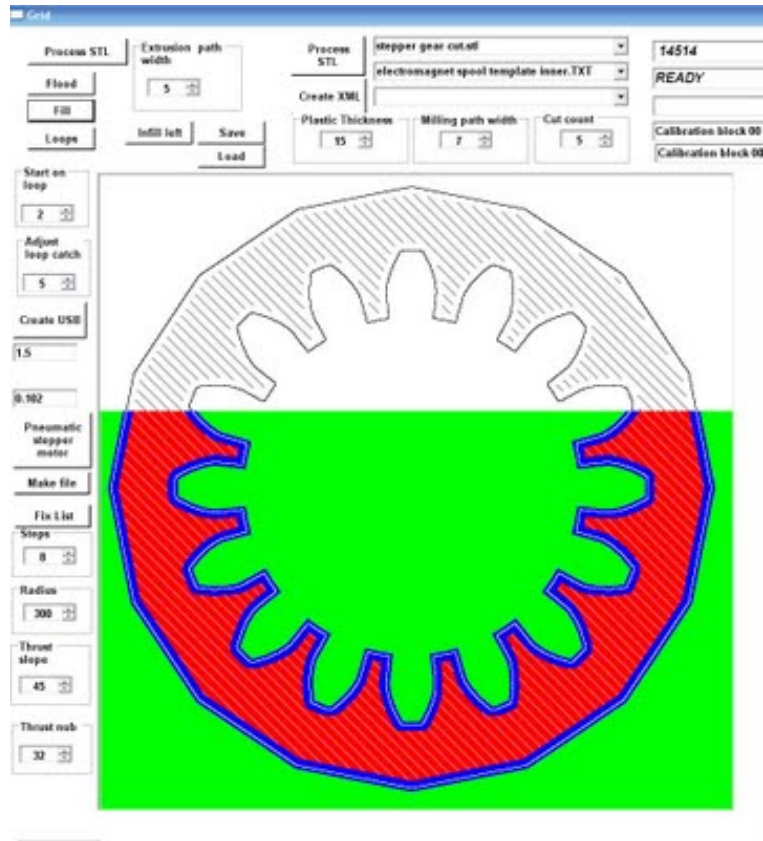

In which your narrator rebuilds Tommelise's Slice and Dice app.

Simple PWM Output Design - Spoondriver

Friday, 14th August 2009 by Vik Olliver

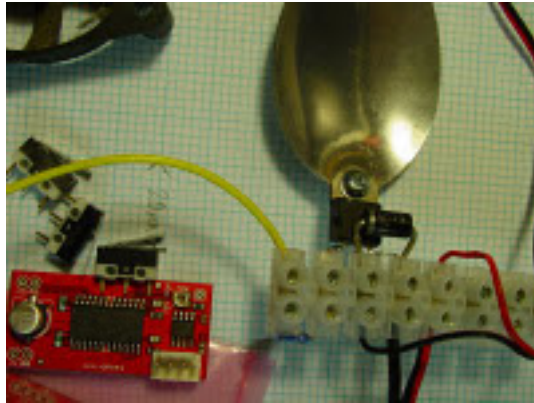

This is how I've managed to build one channel of a budget PWM driver without using a circuit board or solder. Yes, the essential driver components minus blinking lights fit comfortably on a piece of 5 module long small terminal strip. In this photo the spoondriver is connected to a thick pair of power leads, a thin pair of drive leads which in this case power a fan, and a yellow lead which goes off to an Arduino output or similar.

The spoon? Oh, if you're driving a device that consumes an amp or four, you'll need a heatsink. I always hated those cheap, shoddy spoons and raided the cutlery drawer. There's one spoon that won't get stuck in my drawer again.

Vik :v)

RepRap at Hacking at Random 2009

Monday, 17th August 2009 by Adrian Bowyer



I just got back from [HAR2009](#) in Holland - an amazing event, and many thanks to the organizers for inviting me to give a talk. As I walked through the main gate, the first sight that greeted me (bottom left) was a RepRap that someone had left on a picnic bench while they went to pitch their tent. So I knew that this would be cool.

There were many reappers there. But in particular I'd like to thank Erik de Bruijn, Marius Kintel, Philipp Tiefenbacher and Siert Wijnia - when I set up my talk, they all came onto the stage with their machines and got them running. A sort of mass reaping...

There were some other guys who set up their repstraps too, but unforgivably I didn't write down their names. Sorry. If they e-mail me, I'll add them to this post.

-
[More pictures here.](#)

Buying a Rapman

Friday, 21st August 2009 by Forrest Higgs

After some weeks of soul searching and accepting the fact that my day job has cut rather severely into the time I have to devote to Reprap, I arrived at the conclusion that I could address my research agenda much more efficiently if I simply bought a 3D printer rather than rebuild Tommelise 2.0 or build an all new Tommelise 3.0 to do printing.

There are currently two full kit Reprap machines, the Makerbot and the Rapman. Although I was seriously considering using a Makerbot extruder with Tommelise 2.0, when I made the decision to buy a full, separate printer a few days ago I decided to go with the Rapman. It was a tough decision given the price differential between the two. The Rapman choice hinged primarily on what appears to me to be much more personally familiar PIC-based electronics used in the Rapman. What really sold me, however, was Batist Leman's videoclip published in the Builders' blog a few days ago. It was one thing to know intellectually that the Rapman could run autonomously from an SD card. It was quite another to see Batist demonstrate it.

I am going to keep Tommelise 2.0 as a milling machine. It is very good at that. The Rapman I hope to use to generate parts for Tommelise 3.0 and, more importantly, to extend the know how for the turkey bag approach that Adrian demonstrated a few months ago. I purchased another Rapman extruder to use exclusively with HDPE. If the turkey bag approach gets HDPE warping under control we will have effectively halved the price of feed stock for Reprap machines and captured a huge waste plastic resource if and when we get recycling working.

I am also hoping to get back to the research thread I started a year ago to develop a printable stepper motor. Having a reliable 3D printer should advance that cause considerably.

Mendel Sighted In The Wild

Friday, 21st August 2009 by Vik Olliver

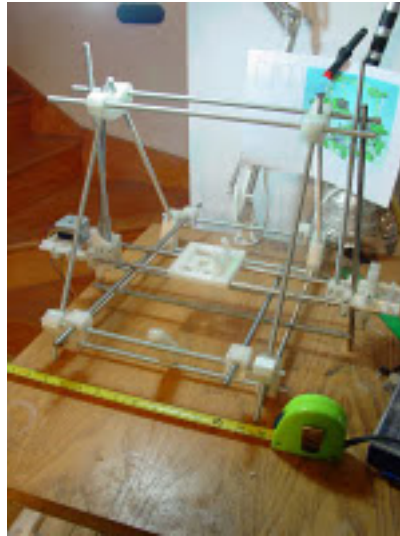

A structure that could be the beginning of a Mendel has been seen lurking in the workshop. It must be stressed here that Mendel is not yet even in alpha status, so changes in design are almost guaranteed. But thanks to the miracle of Open Source, those who enjoy building stuff that hasn't been designed yet can join in the fun.

Because this one is being printed by Phoenix, the original Child RepRap, I've decided to call it "Mendelssohn." This will make Mendelssohn a 3rd generation RepRap. Although it looks - and is - a lot smaller than the Darwin design, Ed's cunning artifices have made a machine with a greater printable area than the original Darwin. It'll be a lot easier and cheaper to put together too - after we've fiddled with it for a bit.

Now to convert the rest of the pieces into gcode...

Vik :v)

Wedge progress

Wednesday, 26th August 2009 by eD

Well, as you can see the Wedge has come a long way since the first concept, and after some critical design changes we're close to knowing whether it'll qualify as a cartesian design for Mendel (the next RepRap printer release).

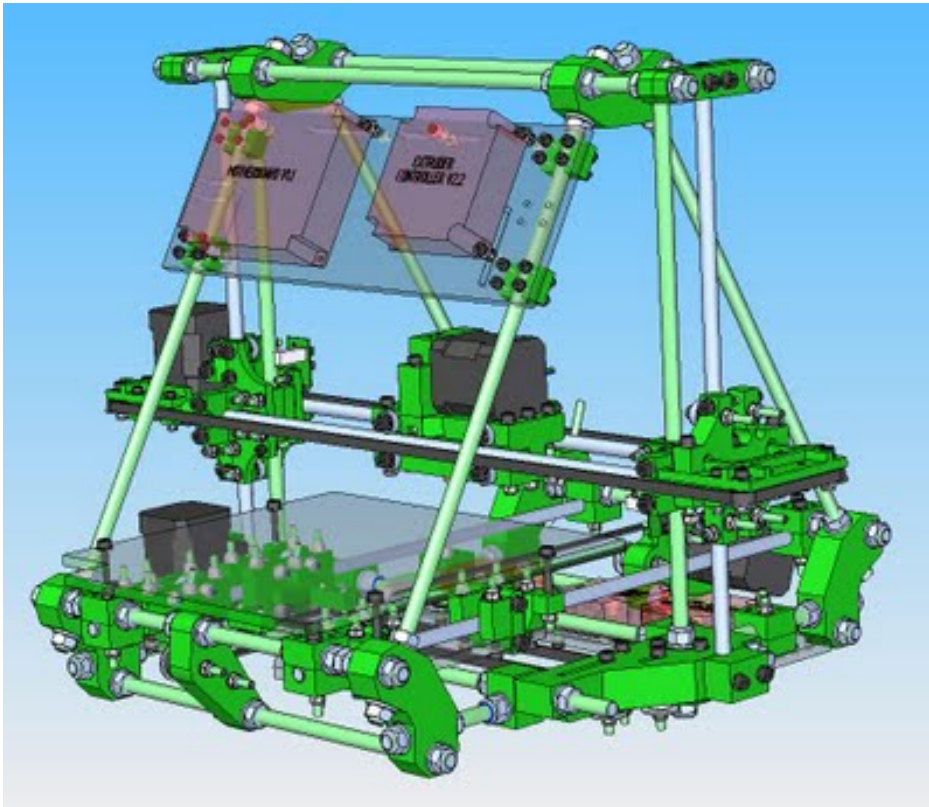

Vik's already introduced it [below](#) and is working hard on a prototype as we speak, but I thought I'd chuck out a few tasty details. Those with a Darwin may appreciate some of the latest specs:

- The footprint is 420 mm x 420 mm, with a cantilevered x-axis of length 512 mm. Height is 345 mm.
- Print area is currently 160 mm x 220 mm. This could be improved to 200 mm x 220 mm with the use of the Bowden extruder (which could rely on a smaller carriage)
- Print height will be ~ 160 mm.
- Assembly requires only 3 different bolt sizes (M4 x 40, M4 x 16 and M3 x 20).
- Axes run on bearings (624s and 608s). The beauty of the wedge configuration is that axes are not over-constrained... this means that all axes can be easily powered with NEMA 14 motors. Motor brackets are also compatible for NEMA 17s.
- Top gantry available for tool-head changer

We're building a prototype in our lab as well. I've had a lot of requests for documentation €“ this

will follow in good time. It's one thing to knock up something that works... but getting things user-friendly for the rest of the world is a different kettle of fish entirely. I should say that the RepRap lab here at Bath University is working flat out to get it out asap, so your patience would be greatly appreciated over the next few months ;-)

Meanwhile here's a VRML of the general assembly so far to get your teeth stuck into.

Mendelssohn Update

Thursday, 27th August 2009 by Vik Olliver



Well, you've seen the nice diagram from Ed so here's what the framework looks like when you put it all together. One change becomes immediately apparent - there is no longer room for a cat to hide inside or under it. Things seem to basically fit, though it might be an idea to wrap tape or plastic shim around the Y bars to ensure they're gripped firmly.

There is a little flexion at the top of the assembly. It is possible that with the right speed of head movement at the right height we could get some vibrations building up, however I have not fitted the board holder or the Z axis guides, which may well add more rigidity.

The extruder holder is a simplistic design, basically because there are not enough 625 bearings in my part of NZ to build a Mendel (Gary just cleaned out the local supplier!). I found PLA on silver steel slides just beautifully, so I'll be using that approach for the prototyping. For the vertical guides I'll probably just push some CAPA in for the moment.

So, now comes the tricky bits - saddles, gears, pulleys etc. This prototype will probably experiment with 3 types of belt drive - 4.5mm ball-chain as successfully used on Darwins for the Z, E-Sky EK1-0503 model helicopter belt (sadly not quite long enough for the proposed X axis) on the Y, and if I can print gears for the 3.5mm ball-chain that'll go on the X axis. If not I'll install the standard Darwin X belt.

Vik :v)

Giving Mendel Teeth

Sunday, 30th August 2009 by Adrian Bowyer

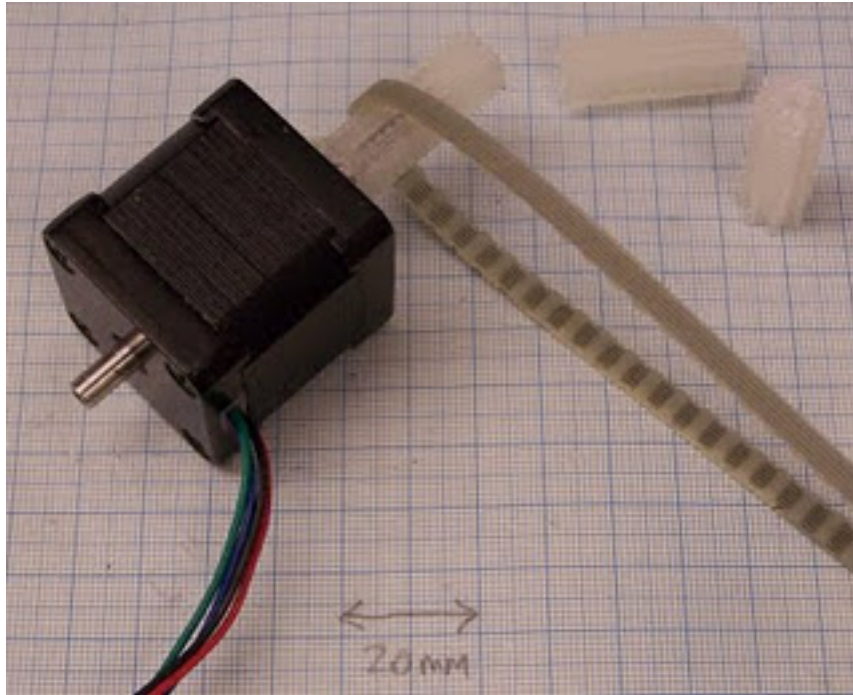

I am particularly fond of Vik's bath-plug drive, but it's too lumpy for the X and Y axes. His model-helicopter belts will work well for these, but we can't print the drive gears for them, as the teeth are a bit too fine.

Toothed timing belts are a perennial problem for RepRap: we can rewrap drive gears for the 5-mm (0.2") pitch ones with no difficulty, but not for a finer pitch. But the 5-mm pitch belts generally have a minimum width of 10mm, whereas we really need 5mm-wide belts. Otherwise the whole thing gets too chunky.

I think I finally have a solution: split a 10mm-wide belt to give two 5mm-wide ones. I made a jig...

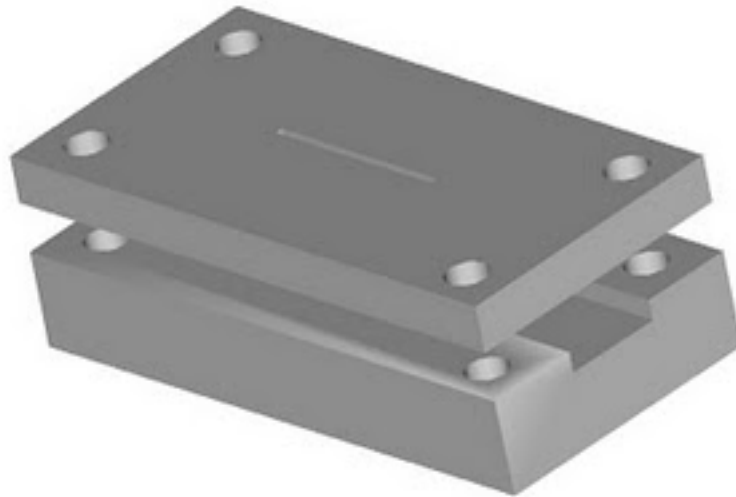

...that you can put the belt in, stab it with a box-cutter/Stanley blade, then pull the belt through. The [AoI file](#) for this is in the [Mendel section of the subversion repository here](#). Because timing belts have cords (usually kevlar or steel) running along them lengthwise to stop them stretching, the split works particularly cleanly as it cuts between two cords. And 10mm-wide belts with 5mm (0.2") pitch seem to be universally available and cheap. You can see the result at the top of this post.

I've designed a belt drive gear ([here](#)) that you can also see on the NEMA 14 motor at the top. This should work for all three axes of Mendel.

Incidentally, when reapplying something like this with a low cross-sectional area there can be problems with each layer of the part getting too much material deposited on it if you use the same reapplying settings as for larger parts. To avoid this:

1. Print the part along with other things of the same height or higher (this effectively increases the cross-sectional area), and
2. Increase the layer thickness slightly. I use 0.3mm for normal builds, and 0.5mm for tall thin things.

The drive gear does need the motor shaft to be filed to have two flats:

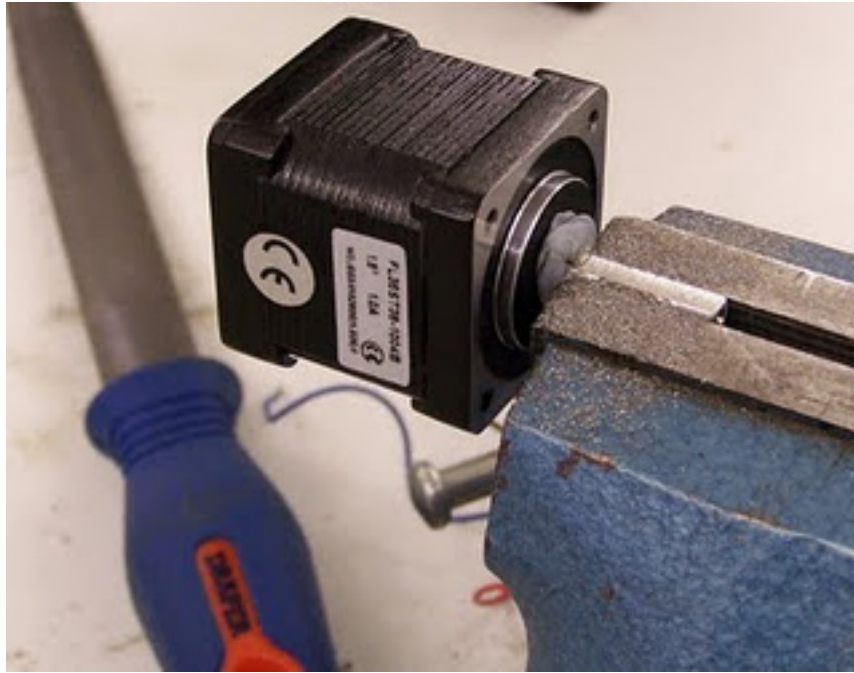

The way to do this is to:

1. Put Blu-tack in the bearing hole to prevent iron filings getting in the bearing,
2. Clamp the shaft, not the motor; carefully get it parallel to the vice by eye,
3. When filing, check frequently: if the flat shape is a rectangle, it's parallel to the axis; if it's a trapezium, it's not.

With a little care you can get the size right within 0.1mm.

Mendelssohn Z axis operational

Sunday, 30th August 2009 by Vik Olliver



I've got the Z axis going on the Mendelssohn design. In the picture here (RepRap is tilted so the bottom faces the camera) you can see the ball-chain drive connected up to the two Z threaded drive bars. The shiny pulley is a 608 bearing with some great big washers either side of it. Side note: If you put M4 nuts on an M4 bolt, the exterior diameter of the nut is 8mm and it fits perfectly as the axle for a 608 bearing.

The 4.5mm beaded chain gears are the same as used on the RepRap Child/Phoenix machine that built Mendelssohn. Printing a gear with a grub screw and captive nut was too hard, so I devised a clamp-on gear that fastens onto the NEMA17 shaft using an ordinary hose clamp. The tensioning pulley makes installation of the Z drive chain much easier on this prototype than the Darwin.

If you want to see it in operation, here's a video of it. I've stuck a mole grip on the X axis to add a bit of weight, and in case you can't see the ammeter it's running at 250mA. It ran like this for 20 mins, cycling up and down without overheating the motor or the EasyDriveV3 stepper driver. The OLPC is just powering the Arduino board - though some magic is needed to stop the OLPC powering down its USB ports at inconvenient moments. Once that's sorted I'll be able to power a RepRap using Ralith's minimalist RepRap command line utilities.

Vik :v)

PS I've since made the Y axis move back & forth using helicopter belt but need to print new bits to do it properly. People are asleep now, so I'll leave that for tomorrow.

Mendelssohn Y axis operational

Tuesday, 1st September 2009 by Vik Olliver



Here's my toothed belt design for Mendelssohn using the Darwin-style moulded gear. I've turned Mendelssohn on its side, so you can see the Y axis workings clearly. I'm just using the NEMA17 to drive this at 250mA, so it won't get hot enough to melt the CAPA. The belt is the E-SKY model helicopter belt, and there is just the right length once you've cut the loop.

The big silver idler is a 608 bearing and 2x ridiculous washers as per the Z idler. The less heavily loaded small belt guide is an M4 soft, black plastic spacer between two M4x11 washers (plenty of lubricant). The belt is clamped by printed pillars (shout up if anyone wants the design files BTW), each held by 2 M4x40mm screws.

The base itself is 230x230x9mm MDF, supported on 16 x M4x40mm countersunk screws clad in 20mm lengths of stiff rubber tubing. These go into 4 PLA pads, which can also be hand-formed from CAPA. These pads have a very low friction, and can be levelled individually to cope with quite gross manufacturing flaws :) The axis moves at 50mm/s very smoothly with plenty in reserve even at 250mA. Yes, bearings will move much smoother and faster with less wear. But this seems to work for now so I'll move on to butchering the X axis.

Vik :v)

Darwin vs Wedge, the numbers

Wednesday, 9th September 2009 by eD

I've just finished a parts list analysis on the two models: Darwin 1.0.6 (left) and the Wedge prototype (right). Here's some graphs:

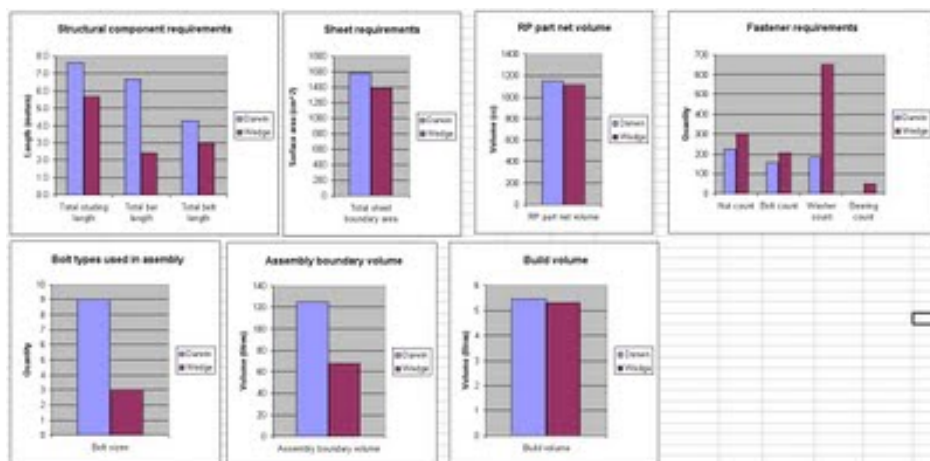
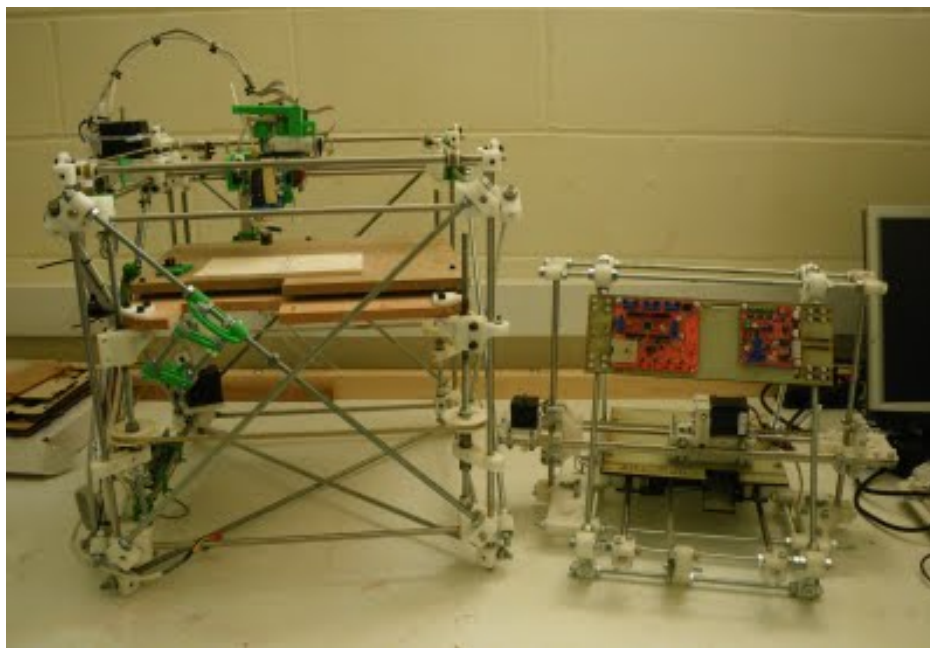

So to very briefly summarise, with the use of bearings the wedge attracts a higher proportion of fasteners. I consider this a small price to pay for much smoother running. The volume of RP parts is the same, as is the area of sheet used in the construction, however the number of structural components is significantly reduced. The assembly has been simplified using only a third the number of different bolt types, and the total assembly volume has halved whilst maintaining a similar build volume.

Here's an analysis of the RP parts in the Wedge design (nod to Forrest for the suggestion). Clearly we could save some volume by optimising the vertices etc etc

RP component analysis for the Wedge. Total volume 1113 cc.

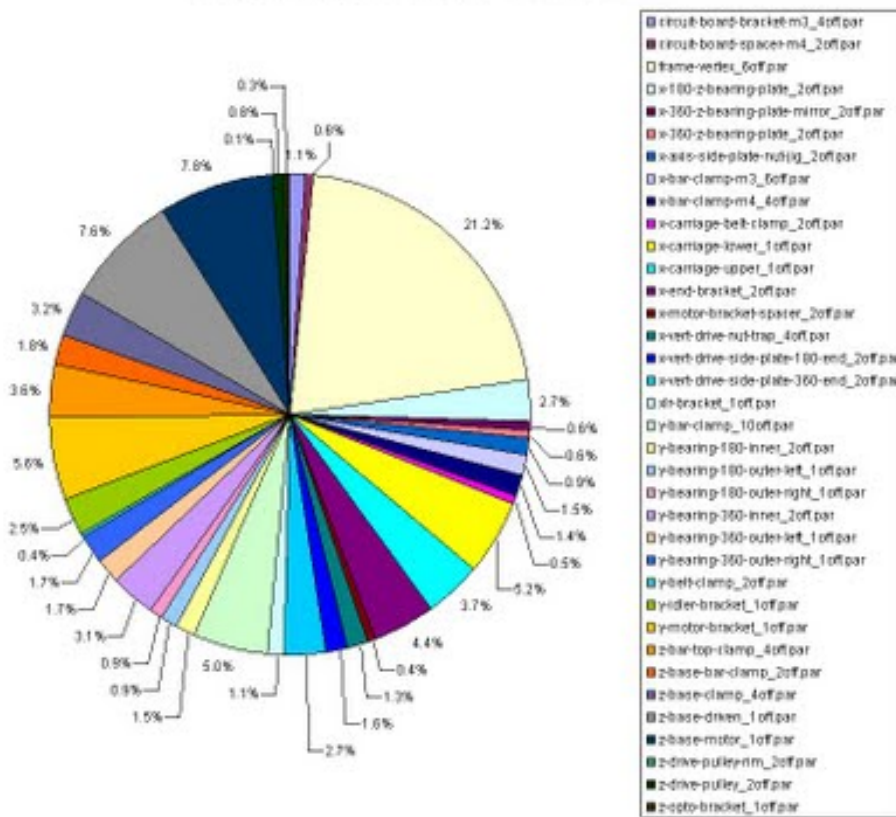

Software Freedom Day 2009

Monday, 14th September 2009 by Vik Olliver



Image not found.

RepRap relies heavily on free software to drive the RepRap itself, create the models of the components, design the circuitry, build the software, and run the websites. Software Freedom Day is about supporting and raising awareness of Free and Open software around the world, so find out your nearest local event and get down there to support all this wonderful stuff. Oh, and show off your RepRap or RepStrap :)

I'll be at events in Albany and Auckland in New Zealand, with even bigger events being held in our Capital, Wellington.

Vik :v)

Mendel Apollo

Thursday, 17th September 2009 by eD

While preparing the Mendel files, we're all building prototype machines in the Bath Uni RepRap lab to get a mini factory up and running. Whilst the other guys are building three standard issue Mendels, I'm going to scratch an itch I've had for a long time: it's that "how big can this thing go", itch ;-). My single motivation is to have a large enough build volume to manufacture all of the printed parts in one single shot. This, in my mind, makes for a much more independent self-manufacturing machine.

I laid up what a single shot build might look like and found the area for printing all the parts, with enough spare room for evolutions, to be 440mm square (marked with a blue line in pic below). That's 5 times bigger than the standard Mendel build area.

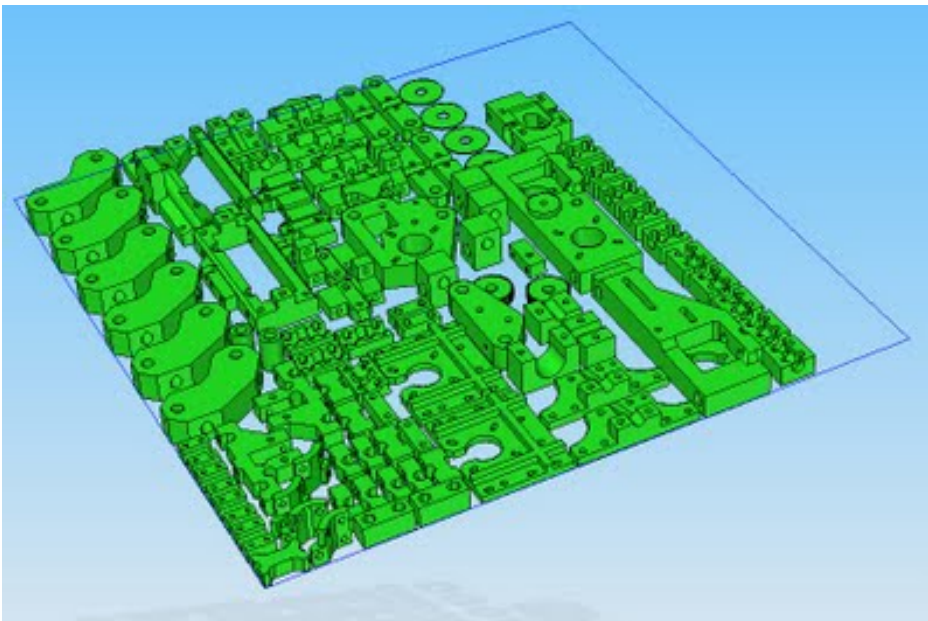

I'm going for a build area of 350 mm x 550 mm. Whilst this achieves the same area as 440mm square, it yields a more manageable footprint out of the Mendel architecture and caters for the fact that most print jobs are rectangular, not square. I modelled the variant design (I've dubbed it Mendel Apollo after the 440 coincidence) and here's a pic comparing the two volumes. Note: the Apollo model is fairly naked: electronics/brace plates need to be added.

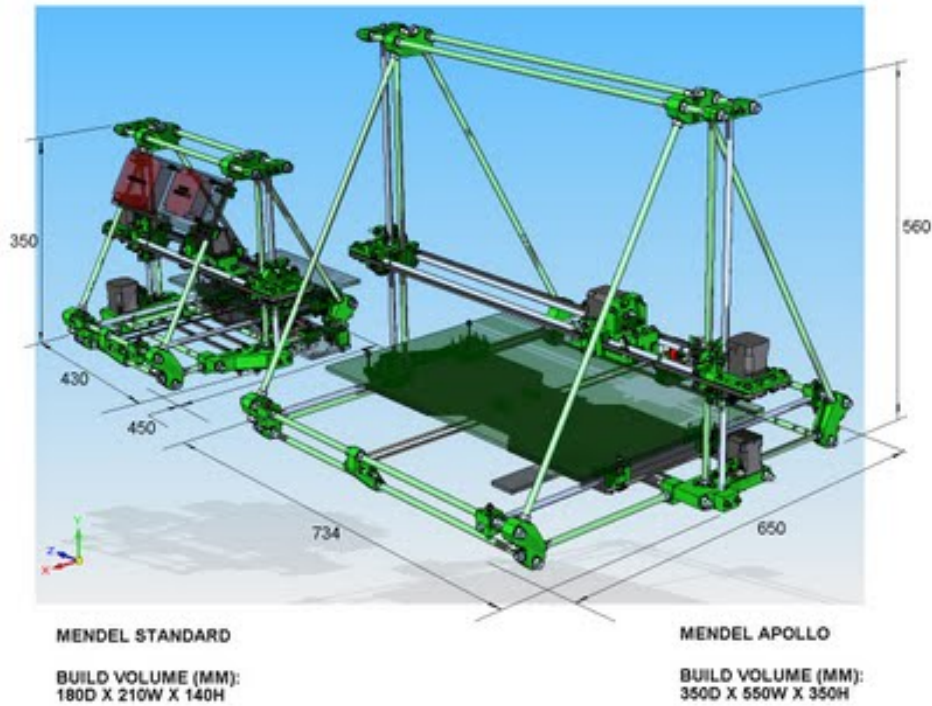

So the Apollo's a big machine, and with its size will come all sorts of wonderful problems. Structural for sure... how will the M8 components fair? No doubt reinforcements will ensue. Will NEMA 17's pull the bed around OK? There will also be a huge test of reliability for the one-shot build, specifically for the software and extruder mechanics.

I think this will be interesting. I believe it will be a bit of a milestone if we ever get that single shot replication and in doing so it may establish some mechanical limits. But before I can scratch the itch, I need to keep going on getting the standard Mendel files finished... grrr

My Extruder Doesn't Work. What Can I Do?

Friday, 25th September 2009 by Vik Olliver

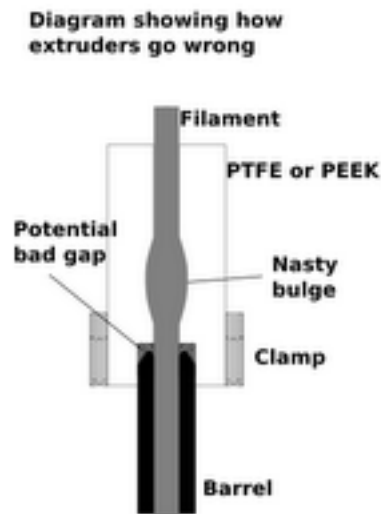

this is probably one of the most common cries of anguish heard from new RepRap owners. The picture on the right shows two common modes of extruder failure. In each case, the symptom is that the filament cannot be pushed through the extruder, or requires enough force to damage the filament even when the nozzle has been removed and the barrel is hot enough for molten plastic to dribble out of it.

To find out what is going on, take the cooled extruder apart and look at the filament inside. If you can't get the filament out of the PTFE or PEEK spacer, the chances are that your spacer has got hot and the filament has bulged inside it. Use hose clamps or a metal sheath to stop the spacer from deforming. You will probably need a new one.

If you see a blob of plastic sitting directly on top of the heater barrel, you have a gap. Any space between the top of the barrel and the end of the hole that it fits into will accumulate plastic. This plastic will not all be molten, and will cause a lot of friction on the filament as it enters the barrel. Typically the extruder will run for a while, but mysteriously clog up if you let it cool and restart it. Or it may just jam solid.

The cure is to taper the top of the barrel to ensure it is driven into the PTFE or PEEK spacer, and to remove the thread from the top 1mm or so of the heater barrel. If the hole has not been tapped all the way to the end, this will let the heater barrel reach the bottom of it. It is important to clear any remaining melted filament before fitting the barrel back!

Vik :v)

Mendel's first print!

Friday, 2nd October 2009 by eD

Thanks to hard work from Patrick on assembly, and Adrian on getting the new extruder board working, the mechanics of the Mendel printer have just been brought to life:

Sweet.

Oh, and I've just finished re-working the design to make the whole kaboodle printable on a 10 cm x 10 cm bed. Good news for MakerBotters ;-)

Hello World

Sunday, 4th October 2009 by Rhys Jones

Hi! My name is Rhys Jones, you may have seen my name mentioned on the blog before, as I previously worked on the firstreprappedcircuit as part of my undergraduate degree. After that, Adrian kindly offered me the opportunity to do a PhD on RepRap, specifically I'll be investigating the use of multiple materials, so you'll be seeing my face around here for a few years.



Anyway, I've had a couple of ideas of ways that we could improve the current process, which I'll be investigating over the next few weeks:

- Circuitry - When we tried depositing solder the results were far from perfect, whilst I'm sure it could be improved, I'd like to give an alternative a try. Wire glue (A.K.A graphite mixed with adhesive) has been bounded around as a potential material for producing RepRapped resistors, but the resistivity is too high for producing circuit tracks. Instead, it may be possible to produce the entire circuit board out of wire glue, and then electroplate the resulting tracks with copper afterwards. Whilst this does require another process, if we are clever about designing the boards, we should be able to bury parts of the track under plastic. This should prevent these parts of the track from being plated with copper, and thus keep a high resistance i.e. we could make both track and resistors with the same extruder. Another nice benefit is that adhesives have a much

lower surface tension when compared to molten metals, so we should be control the material much more easily and produce more detailed circuits.

- Speed - The vast majority of the time taken to build a component is spent extruding the infill. Instead, I think it should be possible just to extrude the walls and only have infill surrounding the major features (holes etc.), leaving several large voids within the part. At appropriate layers during the build, we could then replicate a casting process in order to fill the voids. A potential material for this could be Sodium Acetate, commonly known as hot ice. It's really cool (though not literally), dead cheap, can be made (at least theoretically) using nothing more than vinegar, bicarbonate of soda and a few other items from your kitchen, plus it can "freeze" almost instantly when required.
- One shot build - I really like the idea of a machine that can build all of its own parts in a single build. However, as it stands such a machine is going to be too big to be practical for a lot of people. A way around this is to make more use of the vertical space by building one component directly on top of another. Previously, [Adrian blogged](#) about the use of oil to separate support material from the build. However, the same process could be applied for building on previously built components. It would probably take a major release to make the most of this, but I spy six corner brackets and several other components on the current Mendel design that this technique should work well with.

Of course, all of this is conjecture and could be complete rubbish:D

Rhys

Getting ready for Mendel

Wednesday, 7th October 2009 by Adrian Bowyer

I have done some file reorganizations in the RepRap subversion repository to tidy things for the Mendel release.

Under the location <https://reprap.svn.sourceforge.net/svnroot/reprap> the (partial) directory structure of the trunk is now (the links are for browsing):

[trunk/mendel/electronics](#) - the designs for Mendel

[trunk/mendel/firmware](#)

[trunk/mendel/mechanics](#)

[trunk/darwin/electronics](#) - the designs for Darwin

[trunk/darwin/firmware](#)

[trunk/darwin/mechanics](#)

[trunk/reprap/host](#) - the Java host software (common to both)

The Darwin designs used to be under [trunk/reprap](#), and they still are for the time being to avoid breaking links. But eventually I will remove those.

Some of the Mendel data is already there, and we'll be adding the rest shortly.

Mendel Uploaded!

Tuesday, 13th October 2009 by eD

Done. Woohoo! The mechanical solid-model files are now complete which means all Mendel designs (mechanics, electronics, firmware and software) are now totally available on SVN:

<https://reprap.svn.sourceforge.net/svnroot/reprap/trunk/mendel>

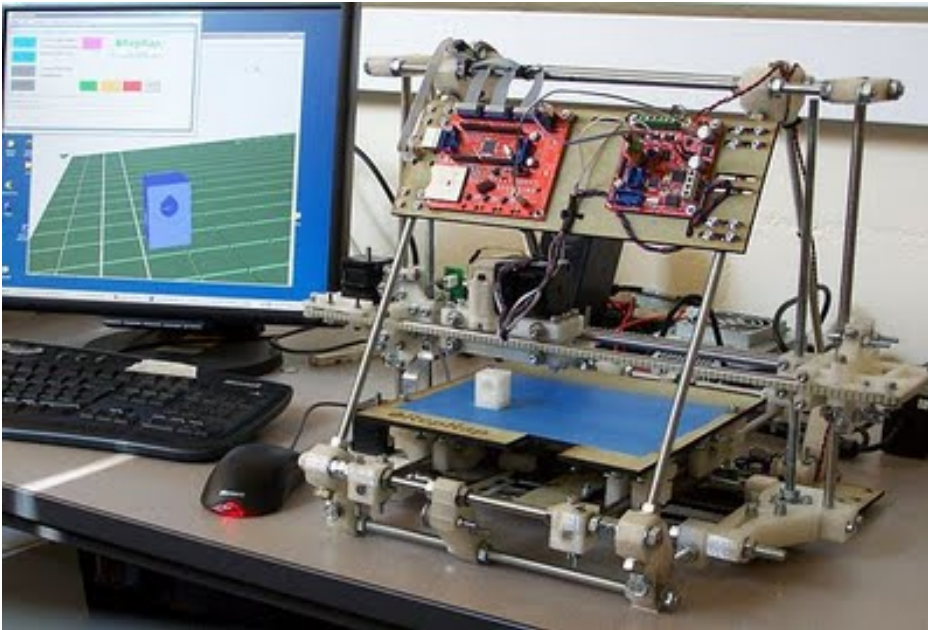

For mechanical aspects:

Mendel cartesian bot files (STLs, and even AOs*) for printing are in /mechanics/solid-models/cartesian-robot-m4/printed-parts

Mendel extruder file for printing is in /mechanics/solid-models/extruders/pinch-wheel/wedge-604

SolidEdge users check the readme in /mechanics/solid-models/cartesian-robot-m4/

Documentation for the mechanical construction to build your own Mendel (!) is now on the wiki. Documentation for electronics, firmware and commissioning is being written now. It's all editable by anyone registered. If you're building any aspects of Mendel please feel free to improve the documentation in true open-source fashion.

Here's another short video ;-) of some of Mendel's mechanical improvements.

Mendel's improvements over Darwin from Rep Rap on Vimeo.

* massive thanks to Paddy and Adrian for their hard work on tying this up. (And also especially to Ed €“ AB.)

MakerBot Love

Wednesday, 14th October 2009 by Adrian Bowyer



Just in case you missed it over on the [MakerBot Blog](#), Fynflood proposed with a MakerBot-made engagement ring. His girlfriend said yes :-) I shall presume to speak for the entire community and say we all wish the happy couple a long and prosperous life together.

Copper Plating Wire Glue

Wednesday, 14th October 2009 by Rhys Jones

I suggested previously that it might be possible to create PCB's by copper plating wire glue to create a low resistance section of track. Also, parts of the glue may be buried beneath plastic to maintain a high resistance, by preventing the plating process in order to make resistors. Anyway, I made a small PCB on our commercial machine, which consisted of a 3mm diameter channel that was later filled manually with the glue. Anyhow, after connecting the PCB to the positive terminal of a power supply and a small copper pipe to the negative, I left it overnight in some copper sulphate solution, with the power supply left at 0.1A (higher currents do speed things up, but the results aren't as tidy):

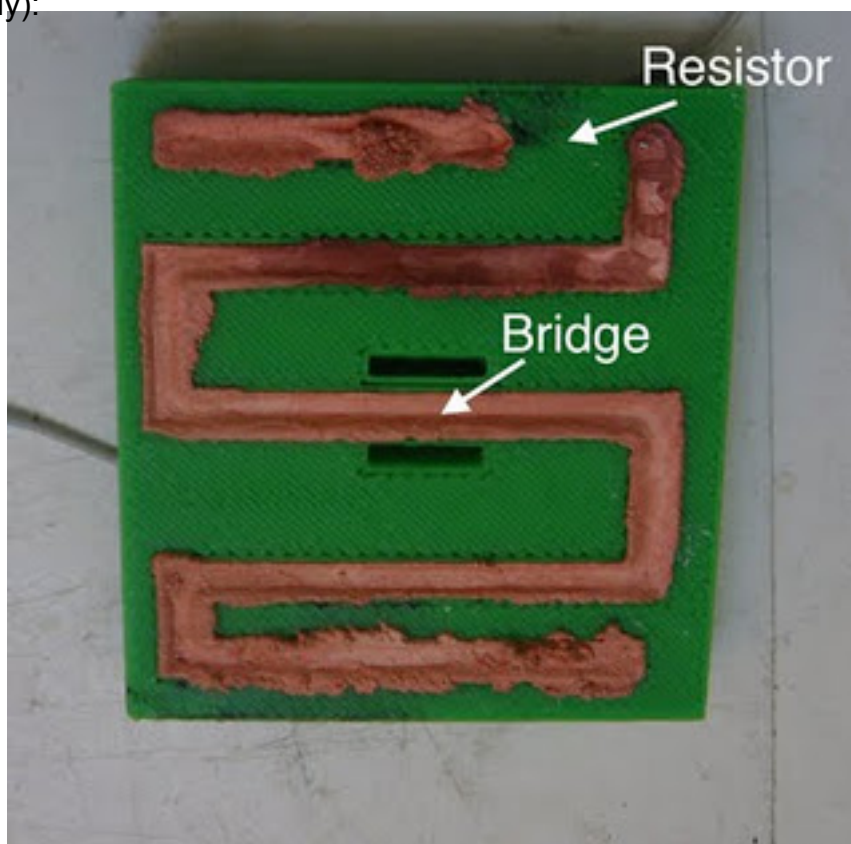

Anyway, it seemed to work, and after a few attempts there were some important findings:

- The resistor shown was roughly 10mm long and its resistance came to 2k Ω , so it looks like wire glue has a sufficiently high resistance to make useful resistors. Unsurprisingly the copper plated sections had a resistance of 0 Ω , and could be soldered to very easily (unlike the circuit produced using the solder extruder).
- The track needs to be connected to the power supply both before and after each "resistor". Otherwise, the track is only plated up to the buried section of wire glue.
- The entire copper plating process is much more even if a small amount of sulphuric acid (car

battery acid) is added to the copper plating solution.

- We need to be able to make several sections of track per PCB, and it is going to be a bit of pain to connect each section to the power supply. As an alternative, I included a small "bridge" whereby the track is only supported by a small section of ABS, such that it is easy to snap out afterwards to create two independent tracks. It seemed to work (see pic below), although its not as clean as I would like, but a support material extruder would help with this enormously.
- It is very important to leave the wire glue to dry sufficiently (at least a few hours). I did make a few attempts where the glue was not completely cured, and virtually no plating was achieved, even when left overnight.
- I did try producing the PCB using PLA on Darwin - it seems our infill settings result in the structure being porous. Of course, this could be easily remedied by altering the settings. However, if we change the infill such that some parts of the structure are porous and some aren't, we can allow the copper sulphate solution to seep into the structure; allowing track to be plated that is contained within plastic. This may prove very useful later on if we ever get around to doing things in 3D.

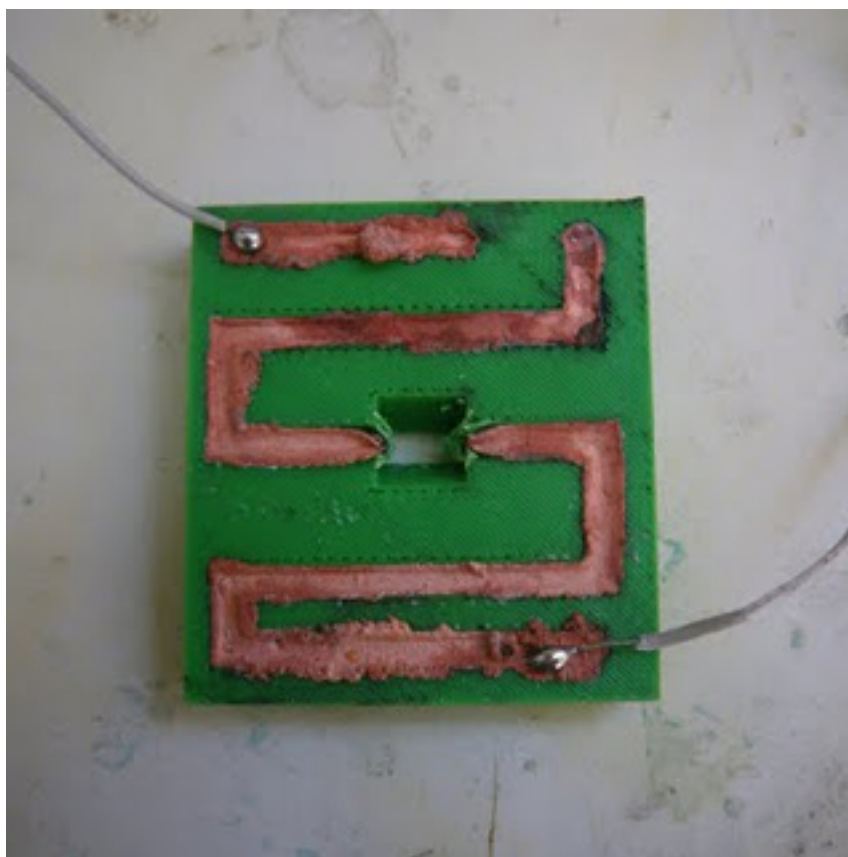

Now where is that paste extruder.....

Costing Mendel

Wednesday, 14th October 2009 by eD

Mendel comes in at £395 for the lot (in the UK).

Assumptions are:

- Using RS (UK) for bought in standard stock (fasteners, bearings, bars, studding and belts)
- 4 off NEMA 17s, @ £20 each
- RP parts @ material cost of £20 (assumes no commission)
- Thick sheet cost (inc cutting cost) @ £20
- Electronics are Zach's Gen3 @ £110

Raw data can be found in the [Mendel assembly data sheet](#) on the wiki. A tabular summary is also available [on the wiki](#).

Here's a graphical breakdown:

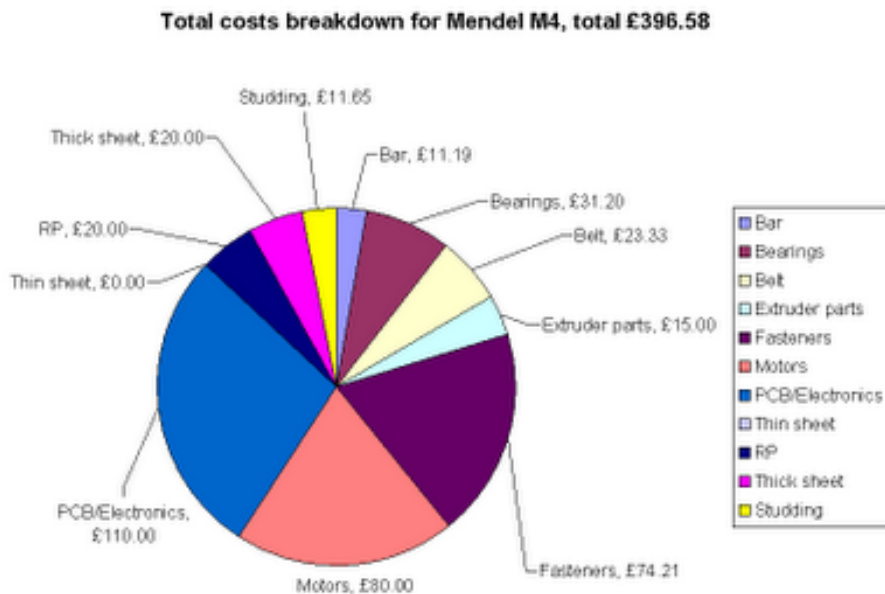

Printing in space?

Monday, 19th October 2009 by eD

Will RepRap work in space? We did an airmile whipround but didn't have quite enough for one of those fancy parabolic flights. So we took the Russian approach and just flipped Mendel instead...

Here's a photo of prints of the same object file in positive and negative g. I would say which one is which but we muddled the order and honestly can't tell the difference.



So it can print in positive and negative g, I guess zero will just be middle ground?

The RepRap Factory

Sunday, 25th October 2009 by Adrian Bowyer

For some time we have intended to set up a RepRap Factory at Bath consisting of four machines that will be dedicated to printing RepRap parts for others. We shall then sell these on at cost.

This video shows this beginning to come together. We could drive the factory machines off their SD cards, but it is more versatile to drive them off host computers. But we don't want to dedicate one computer per machine.

It turns out to be pretty simple to drive multiple machines off one host computer, especially under Linux. I just set up one account per machine. All the accounts had their own copy of the `reppap.properties` file. These were identical except for the communications ports, which were set to `/dev/ttyUSB0`, `/dev/ttyUSB1` and so on.

I then just opened a terminal window for each machine in a separate desktop, executed `xhost +`, did an `su` to the appropriate users in each window, and ran the RepRap host software. I ended up with one desktop per machine (hint: put the desktops in the same relative places on the screen as the RepRap machines are around the computer to avoid confusion). I could easily control them all.

The bandwidth needed to send the G-Codes to the machines is nothing special, so even my weedy old laptop could keep up.

I'm pretty sure one could do the same trick under Windows using the Run As... utility.

Faster production means more RepRaps...

RepRap Extruder Design with OpenSCAD

Tuesday, 27th October 2009 by Wizard23

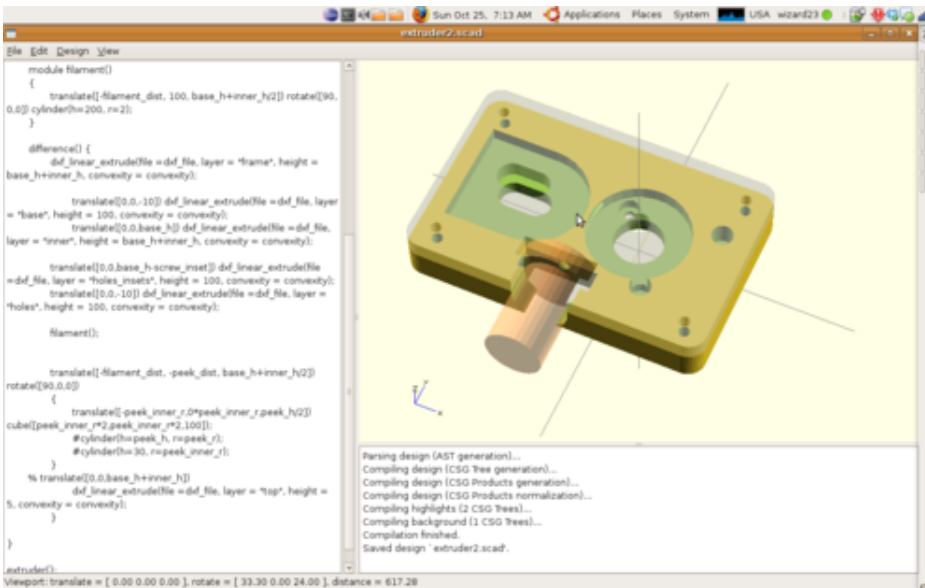

† www.flickr.com

RepRap Extruder Design with OpenSCAD

After falling in love with the new Mendel design I want to try out the PLA Adrian sent us (thanks!) so we need a new extruder which I want to build with parts available here at Metalab. We use different DC Motors for the extruder with a different mount than the steppers in the ingenious Mendel extruder design which I used as an inspiration. I only changed the way the insulator part is mounted since I like our T-slot mount very much. It is very stable and I don't want to glue the insulator like in the Mendel design since I'd like to be able to take it apart. The motor mount will be parametrized so that you can adapt it to different motors by just changing one value.

As you can see in the screenshot I model the extruder in OpenSCAD openscad.org. OpenSCAD is a very cool open source parametric solid 3D CAD modeller available under linux, mac and windows. If you like programming and 3D printing you should have a look at OpenSCAD since it is more like writing code than juggling triangles and vertices like in Blender or Aol. It's Solidworks for programmers :)

the designs of the extruder so far can be found here:

http://reprap.svn.sourceforge.net/viewvc/reprap/trunk/users/metalab/models/scad/printed_lasercut

_extruder/

wizard23

<http://reprap.soup.io>

An end to ooze and support material found ...

Tuesday, 3rd November 2009 by nophead

... a successful days collaboration, see hydraraptor.blogspot.com/2009/11/hacking-with-erik

Before:

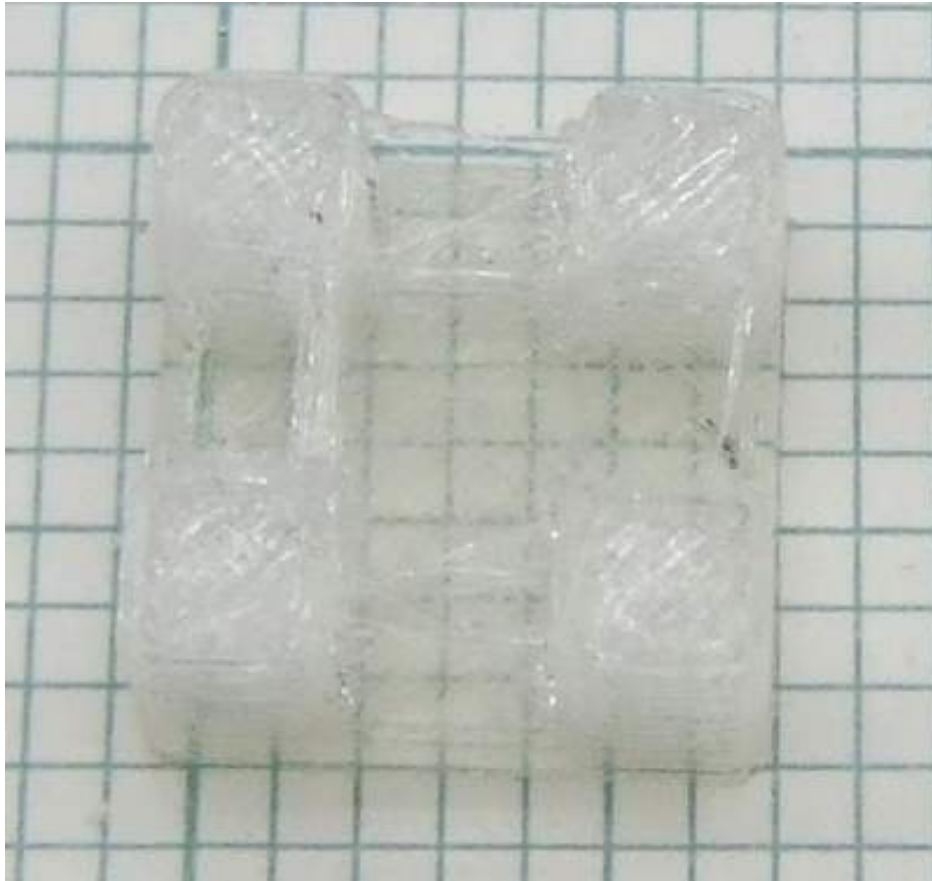

After:



PLA on ABS on PLA:

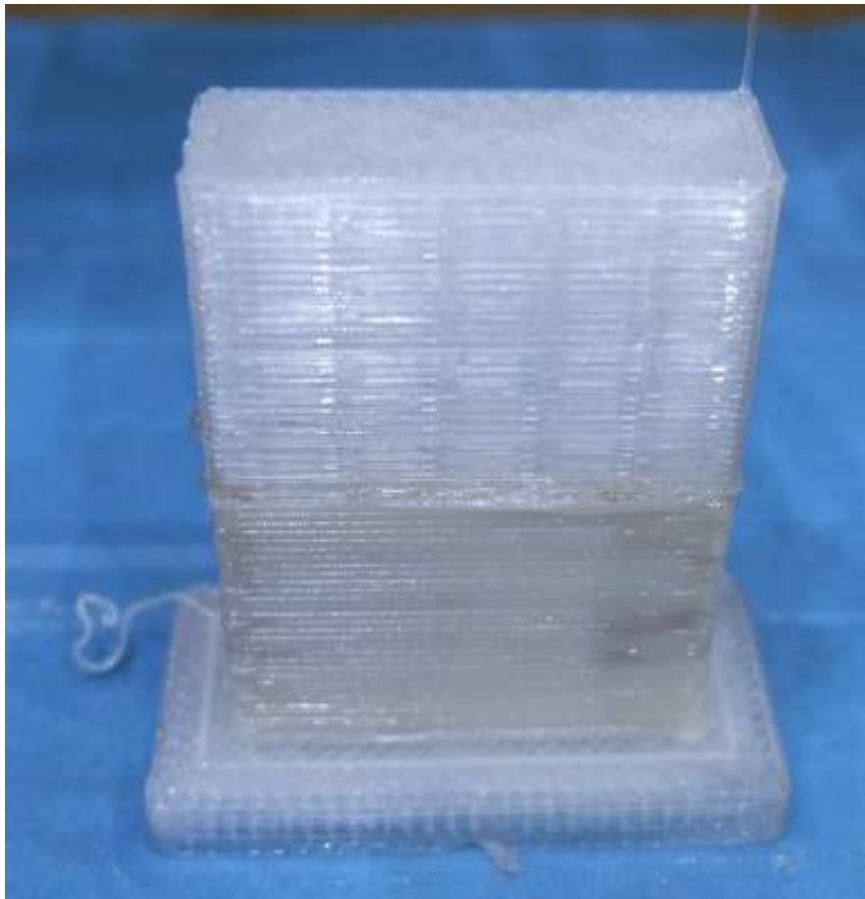

An end to ooze II

Thursday, 5th November 2009 by Adrian Bowyer

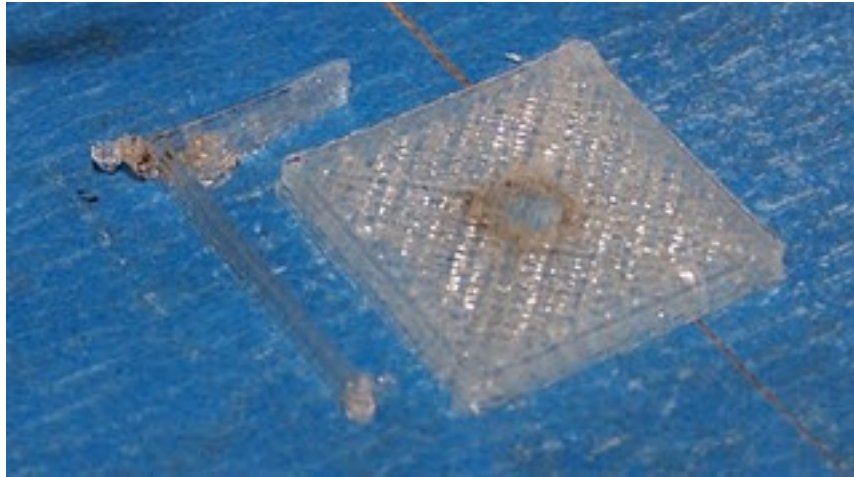

Ages ago, I put code to reverse the extruder at the end of plotting a sequence of line segments into the Java host software, thinking, "That might be useful someday." I set the default so that it reversed the motor for 0ms to turn the feature off, and forgot about it. Seeing Erik and Nop's post below, I thought I'd better finally try it out...

Above is the result - perfect! (Ignore the dark splodge in the middle of the square; that was crud on the extruder falling into the build; I should have cleaned it first.) Normally there'd be loads of string between the L-shaped nozzle-wipe bit and the block being made. Now there's none.

I'm running at an XY feedrate of 3000 mm/minute. At that rate setting `ExtruderN_Reverse(ms)` to 200 and `ExtruderN_ExtrusionDelayForPolygon(ms)` to 400 seems to work nicely.

The delay figure is how long the extruder runs before starting an XY move; this allows the polymer to move back down the barrel to take up the slack.

Rack and pinion

Monday, 9th November 2009 by Forrest Higgs

I've wanted to build a Reprap machine that didn't include a lot of ironmongery for a long, long time. Indeed, I developed a tool script for designing involute profile gears way back in 2006. Last year I milled gears and racks. This year I'm printing them.

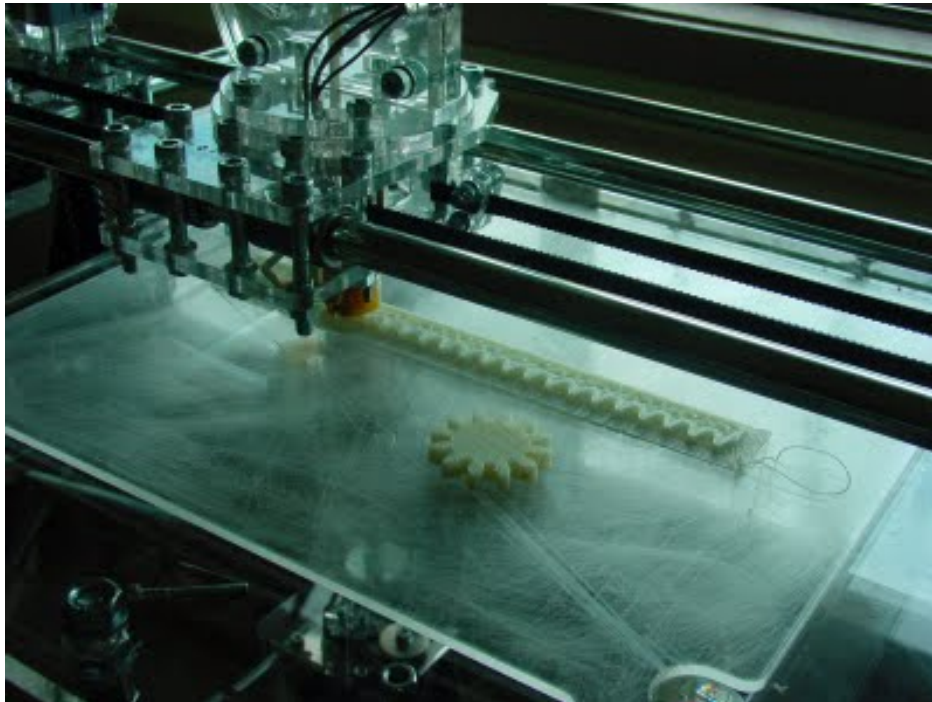

You can see the completed rack with the pinion here.

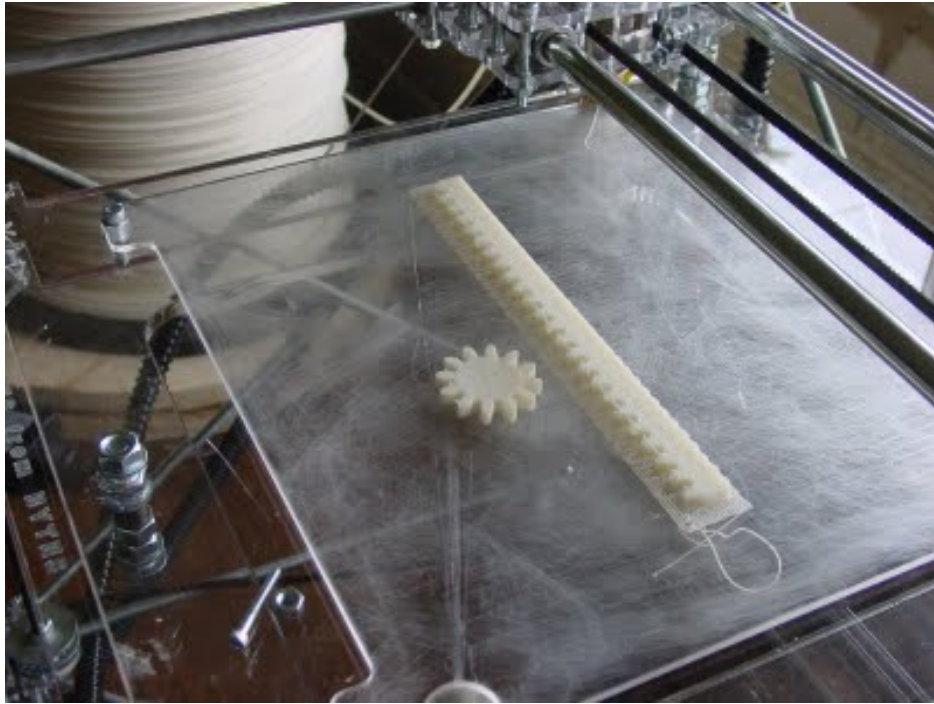

Oddly, though the rack was 190 mm long, it didn't warp significantly.

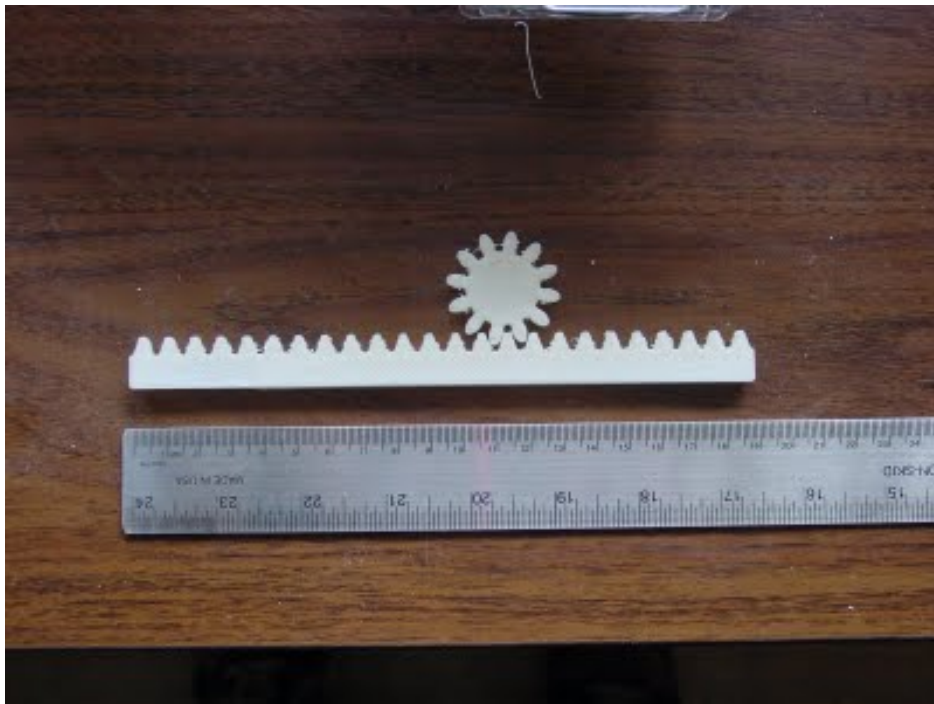

Reprapable Solar Power

Tuesday, 10th November 2009 by Adrian Bowyer

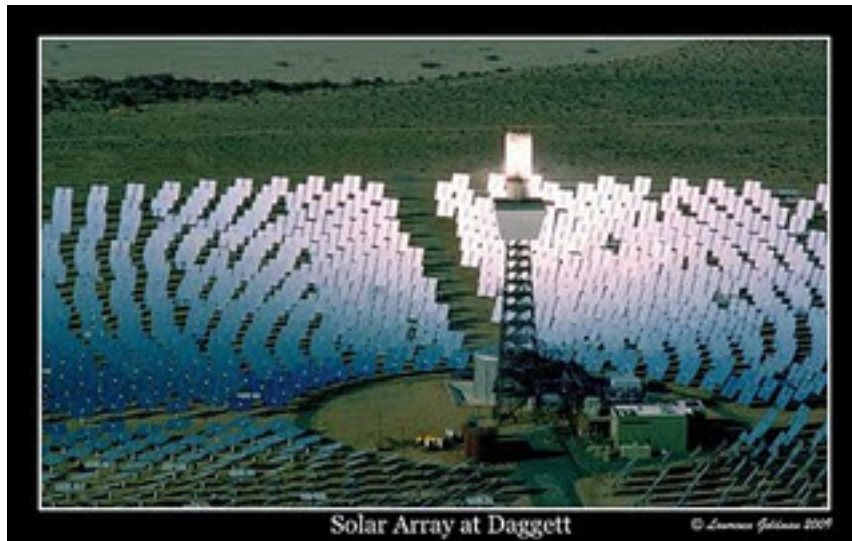

We've discussed reprapping solar panels for a long time, and - of course - our semi-conductor printing capability isn't quite up to that yet.

But it should be possible to reprap a small-scale solar array like a miniature version of the industrial one at Daggett above.

It would use reprapable solar-powered steerable mirrors. Those would be an autonomous motorized gimbal mirror support with a tracker that keeps the sun's reflection pointing the same way at all times (onto a solar boiler, say). The idea is you'd reprap out a load of these, then walk round a field putting them down. They'd all align themselves and start delivering solar power...

I think the trick is to black out a corner of the mirror except for a small circular spot in the middle of the black. Each steerable mirror has a detector on a flexible arm that you place where you want the reflection of that spot to be. Feedback keeps the spot-reflection on station, and hence the main mirror also on station. A really clever design would combine the spot detector with the local solar cell that provides the motor and controller power.

I look forward to the first version on Thingiverse...

Guying long prints

Wednesday, 11th November 2009 by Forrest Higgs

I'm an architect by training with a keen interest in the history of building technology. In the Middle Ages, architects compensated for the lateral thrust generated by domes and vaults with buttresses. In the 20th century architects dealt with inflatable buildings by using guy wires to anchor them to the ground.

When you print long, tall objects in most polymers the ends of the object tend to try to lift off of the print surface. Ordinarily, one uses a raft to more tightly secure a printed object to the print surface. For objects up to about 40 mm that method works nicely. When one goes beyond that, however, the printed object tends to peel the raft off of the print surface.

I spent a lot of time working with HDPE several years ago. HDPE has terrible tendency to curl at the edges. At that time, I thought it would be a good idea to print pads next to the ends of a long printed object and guy the ends down. This spreads the force generated by the upwardly curling printed object. You can see a first effort at this here.

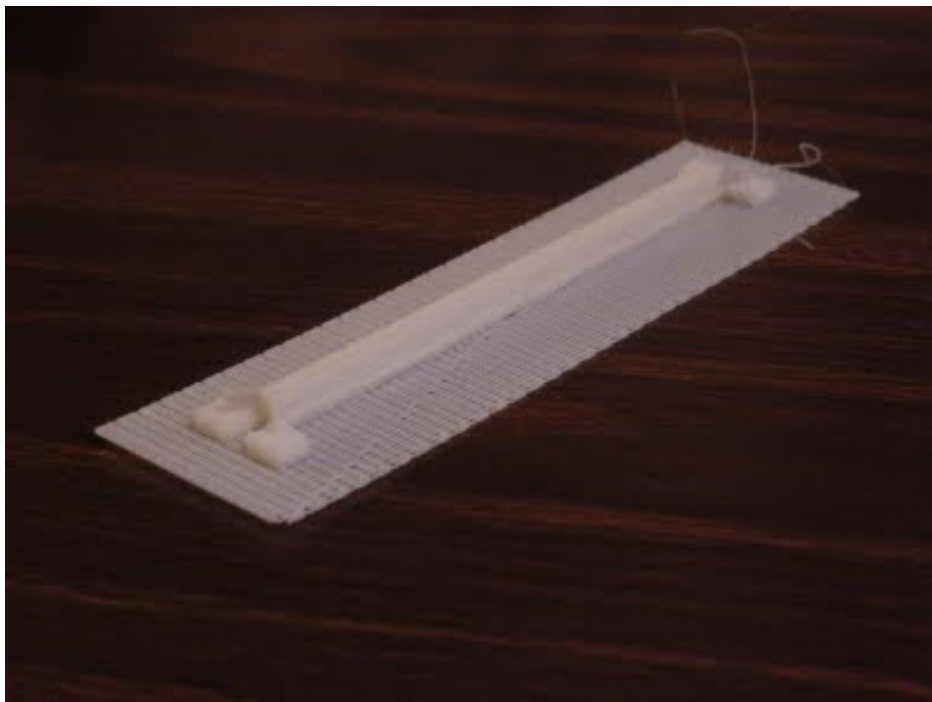

I was trying to print a beam 150 mm long by 5 mm wide by 10 mm high. You can see the details of the pads that spread the tension force and the plates that carry that force down and spread it onto the raft in this closeup.

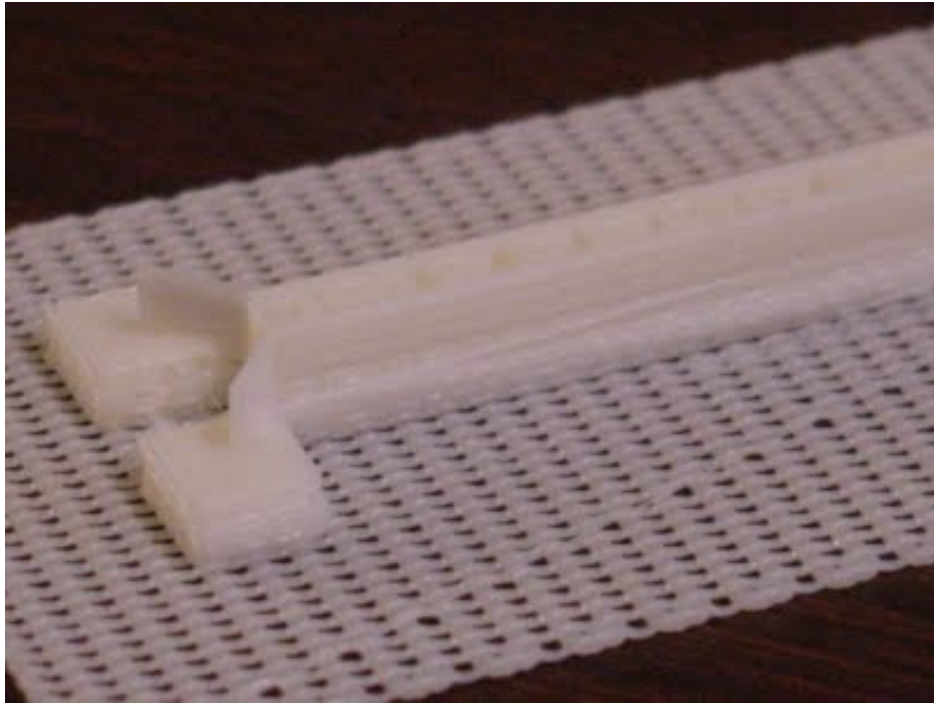

The idea worked, so I increased the height of the beam to 20 mm and tried it again.

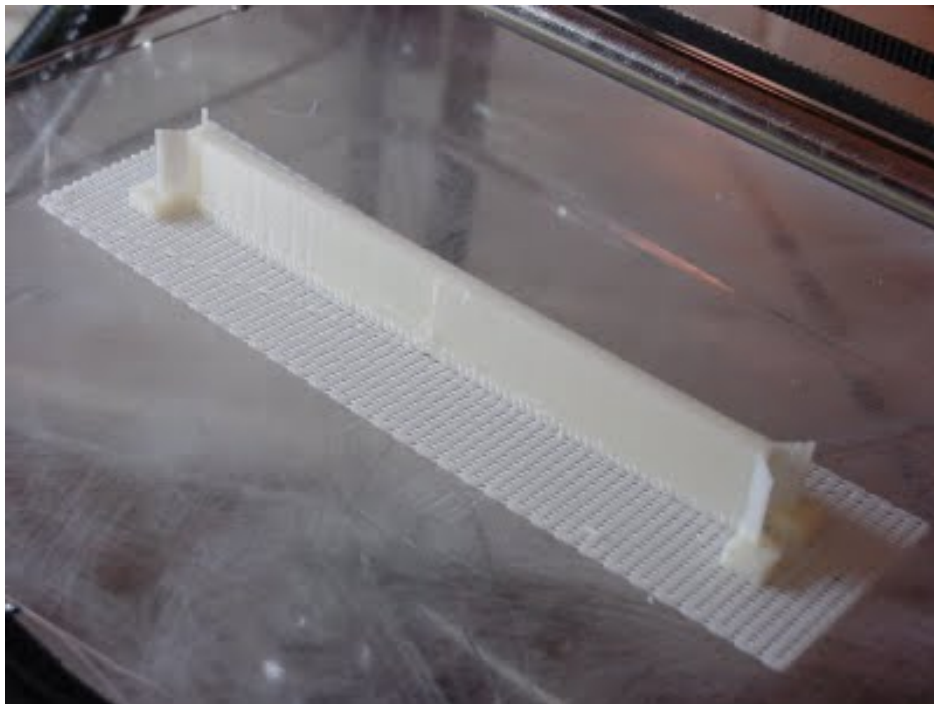

That appeared to have worked, too. What was interesting was that I could easily peel the raft off of the acrylic printing plate and was able to easily peel the raft off of the printed part. The guy flanges and pads can easily be removed with a mat knife.

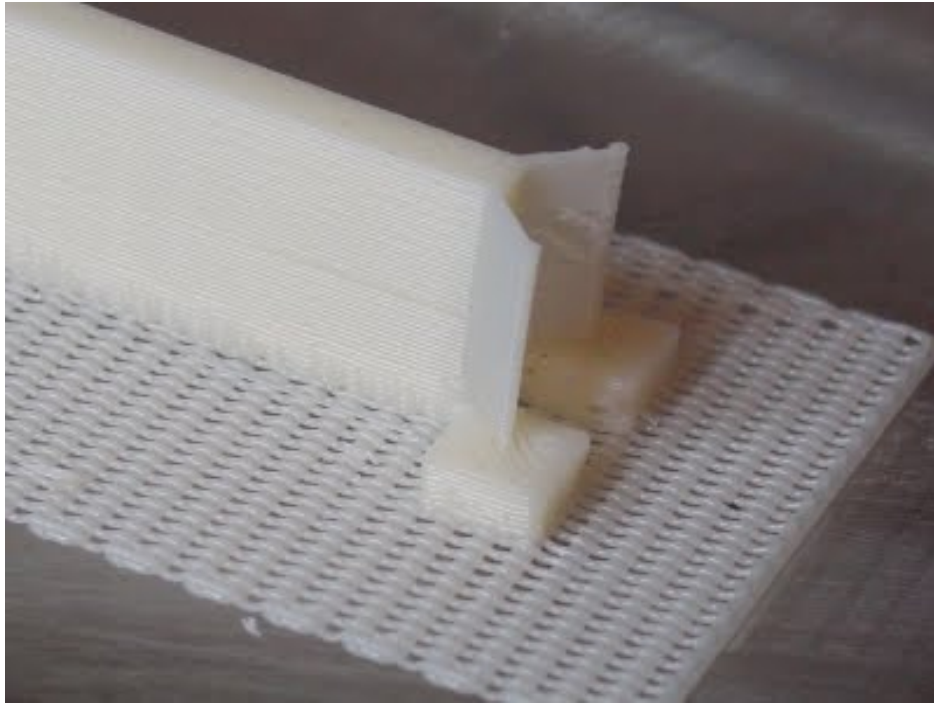

After I removed the beam I noticed that the curling force during printing had actually bent the rather flimsy 3 mm acrylic printing plate provided with the Rapman printer. The downward bowing amounted to 2 mm over the 150 mm length of the beam.

It seems likely that if I use a thicker acrylic printing plate that I can reduce the 2 mm bowing on the bottom surface of the beam. I will see if I can purchase a heavier print plate tomorrow at the hardware stockist's.

I will also measure the bowing of the beam over the next several days to see how much it ultimately distorts.

Wednesday morning: I measured the bowing again a few minutes ago. It is still 2 mm.

I found a bug!

Wednesday, 11th November 2009 by Vik Olliver



A New Zealand cicada by Rhys, Bronwyn and myself. CC-BY-SA licence. Hope to put the files up soon.

No, it didn't print in one piece. It's kinda like an Airfix kit, requiring some superglue and a blowtorch. But it comes out pretty darned well.

Vik :v)

Continued guying

Thursday, 12th November 2009 by Forrest Higgs

I went down to my hardware stockists and acquired a piece of 5.56 mm acrylic sheet to replace the 3 mm sheet that came with my Rapman. That done, I printed my guyed, 5x20x150 beam again using ABS and printing at 16.8 mm/sec. I processed the STL using Skeinforge and used a 40% hexagonal fill.

I removed the beam immediately after printing it...

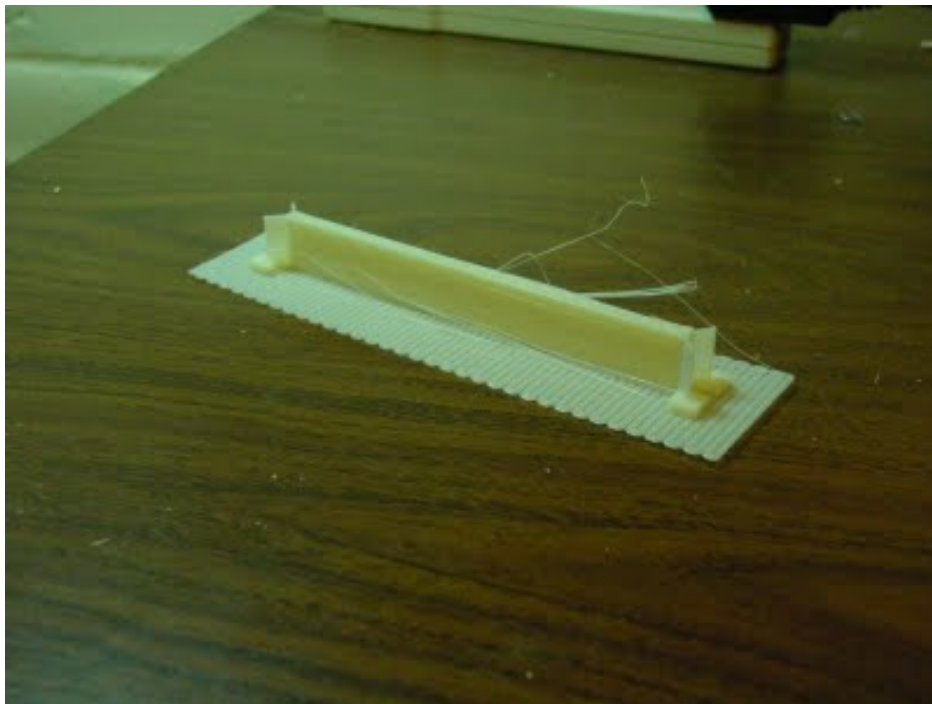

... and stripped off the raft.

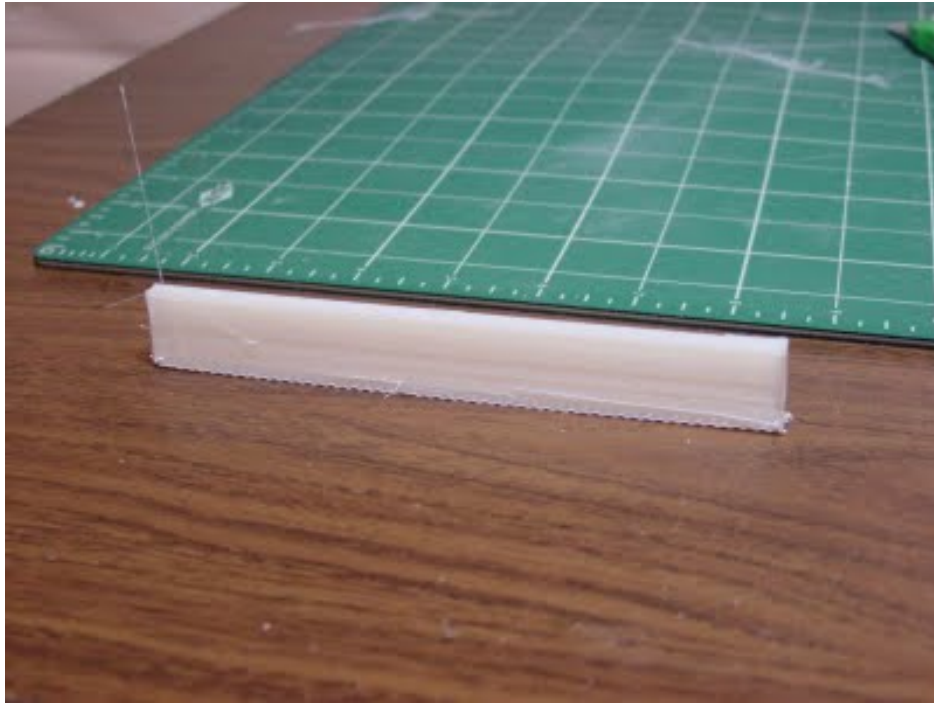

I am not able to detect any bowing in the resulting beam. The raft on which the beam was printed was rather coarse as you can see in the pictures in the previous guying blog item. It may be that there is some very small amount of bowing that is lost in the roughness of the bottom of the print caused by the raft. If there is, I suspect that it is much less than 1 mm over the 150 mm length of the beam.

The STL for the beam with the guyed flanges looks like this...



I would appreciate it greatly if others would try to print this beam in ABS on other Reprap printers so that I can confirm my results. If you are interested in trying this you can get the STL from [here](#).

Thanks.

One thing in passing. If you are going to print ABS onto an acrylic print base, something I can recommend highly, I'd strongly suggest you get one of these.



It is a scraper used by professional house painters to clean enamel off of windows. It separates ABS rafts from your print base very quickly and cleanly with a minimum of drama.

Revisiting HDPE

Saturday, 14th November 2009 by Forrest Higgs

Once I established that using pads and guy flanges suppressed warping in large dimension objects printed in ABS I decided to see if the same method with HDPE. Basically, I printed a 5x20x145 mm bar guyed to pads on the raft.

Some years ago, when I was working with HDPE on my Tommelise 1.0 Repstrap printer the big problem with HDPE, aside from a tendency to warp profoundly, was finding a surface that it could be printed on. I found that I could print on art store foamboard. This material is about a quarter of an inch thick, typically and consists of plastic foam sandwiched between two sheets of plastic coated paper. HDPE would stick to that quite nicely. Unfortunately, however, this material tended to perish when exposed to the hot extruder head of Tommelise 1.0. It also lacked the structural strength to resist the tendency of HDPE prints to curl at the corners.

Recently, Bogdan Kecman, a Rapman user in Belgrade, has been making a serious effort at working through the problems presented by HDPE and polypropylene as printing materials. Yesterday, he was kind enough to offer me advice about what sorts of materials that he found HDPE would stick to. In the list he gave me it appeared that polypropylene sheet offered the best option for printing HDPE. I happened to have a few sheets of 9.5 mm polypropylene left over from my milling work with Tommelise 2.0 earlier this year, so I quickly converted one of these into a print surface for my Rapman 2.0 printer and got to work.

[Guying HDPE prints from Forrest Higgs on Vimeo.](#)

After a few false starts and a careful go at leveling my print surface, I managed to print my guyed beam successfully with no peeling of the raft and NO subsequent curling or warping of the beam.

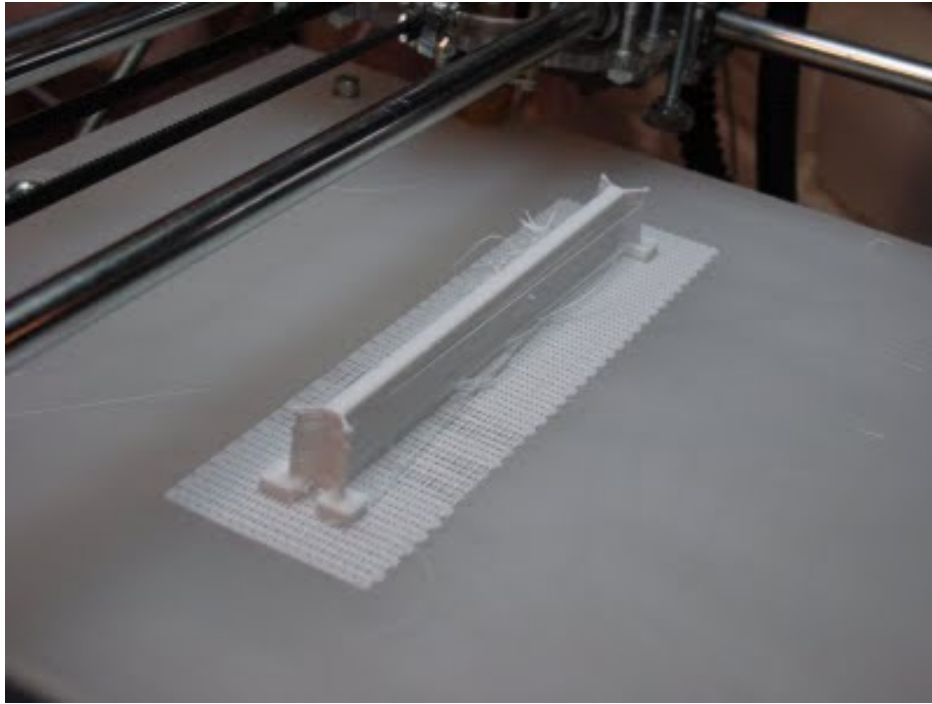

The beam was printed using Skeinforge with a 40% hexagonal fill. the raft was printed at 220 C and the beam at 225 C. The extruder head speed was set at 16.8 mm/sec and the feed rate at 46 rpm. I am not completely satisfied with the surface quality of the beam. I suspect that I am extruding a bit too cool. I will be exploring these kinds of settings in coming days.

One of the most important discoveries of this exercise is Bogdan's discovery of polypropylene as a printing surface for HDPE. It is sticky enough to keep HDPE rafts solidly on its surface and strong enough, in thick pieces to successfully resist HDPE's tendency to curl and warp during the printing process. Without Bogdan's discovery, guying would have been impossible with HDPE.

Polypropylene sheet is also readily available and cheap as well. I shaped it into a print surface for Rapman with ordinary hand tools. It behaves a lot like acrylic plastic except that it isn't brittle at all, a characteristic which makes it much less risky to work with.

HDPE has several advantages over more conventional plastics like ABS and PLA. It is a single polymer and not a witches brew like ABS. When you print with it you can, if you get close to the print head, detect a mild, pleasant odor from the hot HDPE. Try the same thing with ABS and you get a very different experience. HDPE also can be had for about \$5.50/lb {~\$12/kg} compared to \$9.75/lb for ABS {\$21.50/kg} and \$10/lb for PLA {~\$22/kg}.

HDPE also constitutes a very large fraction of plastic waste worldwide if we ever get around to developing small scale plastics grinding and filament extruding equipment that will get us into recycling.

Please understand that I am not suggesting that everyone run out and buy lots of HDPE right now. We have a lot of practical experience using PLA and ABS and we shouldn't dump that. Different

plastics have different uses. What is nice, however, is that it looks like we have another one to add to our list, which, like PLA, has not heretofore been used in commercial equipment.

I am very excited because Bogdan Kecman is going to be testing the pads and guying technique with polypropylene in the next few weeks. If he succeeds, we will have a printable plastic that costs about \$4/lb {\$8.80/kg}. THAT will be a brilliant development for the Reprap endeavour.

More printing large objects with HDPE

Sunday, 15th November 2009 by Forrest Higgs

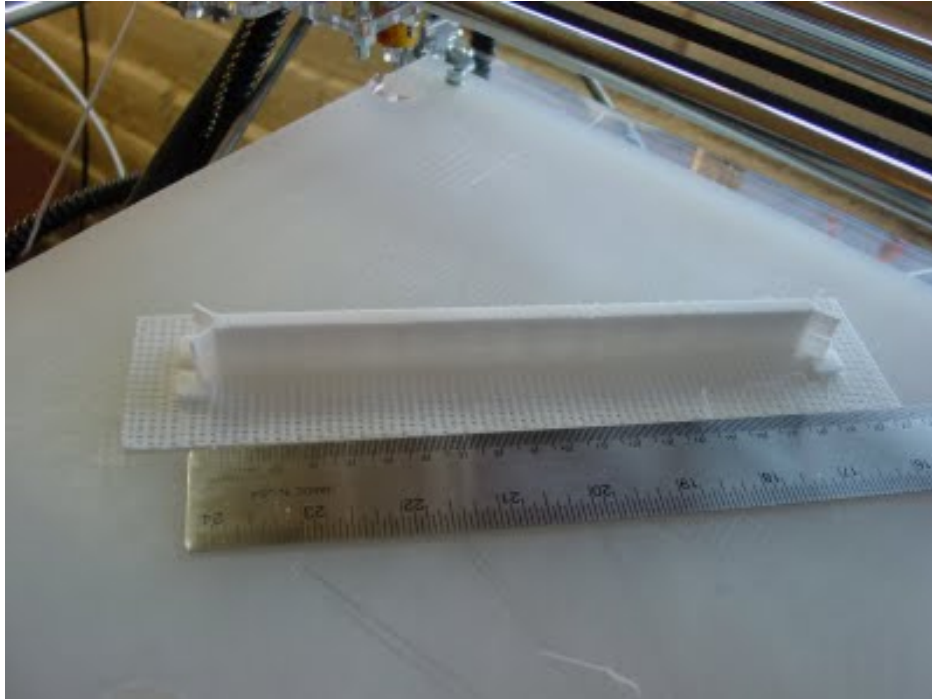

I pushed the length of the 5x20 mm beam out to ~180 mm this time. I got a little bowing because the tension plates began to uproot the raft during the last few layers of the print. For more...

Bogdan's acid test

Sunday, 15th November 2009 by Forrest Higgs

Bogdan suggested that we give the method an acid test and print a 125x125x10 block. I made up a test block in Art of Illusion and gave it a try. I ran the STL file through Skeinforge.

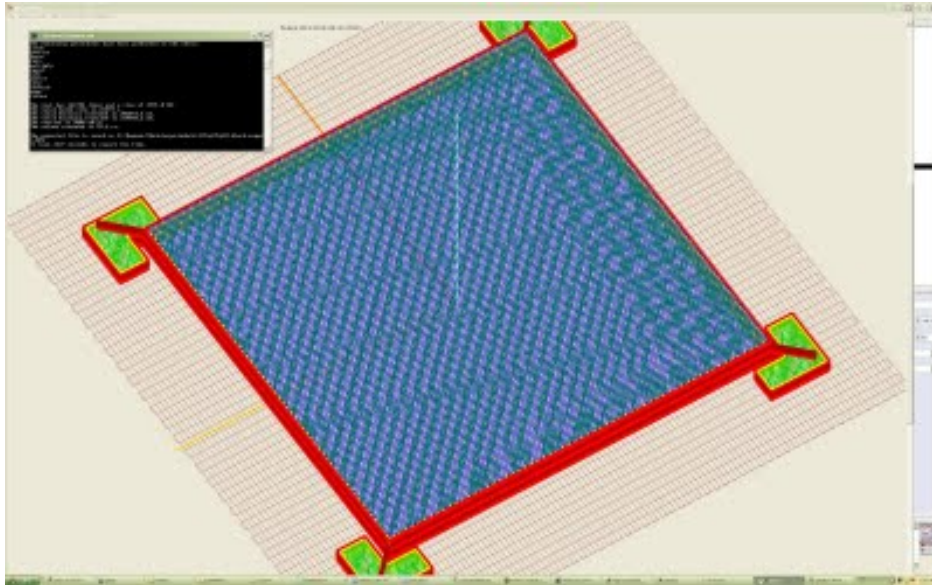

- object: cube {125x125x10 mm}
- printer: Rapman 3.0
- firmware version: 1.0.6
- slice and dice app: Skeinforge, 2009-10-31 build
- material: HDPE {no additives}
- print speed: 16 mm/sec
- extrusion speed: 65 rpm
- fill: 40% using hexagonal pattern
- raft temperature {first layer}: 225 C
- raft temperature {second layer}: 230 C
- first layer temperature: 225 C
- beam print temperature: 230 C
- lab temperature: 18.3 C
- lab humidity: 50%
- raft perimeter width: 12 mm
- beam dimensions: 5x20x180 mm
- print time: ~360 minutes
- print material ~53 cm³
- bowing: 2-2.5 mm over one diagonal {175-180 mm}

I used "L" shaped tension pads. Here you can see the raft printed and the transition layer for the block being laid down.

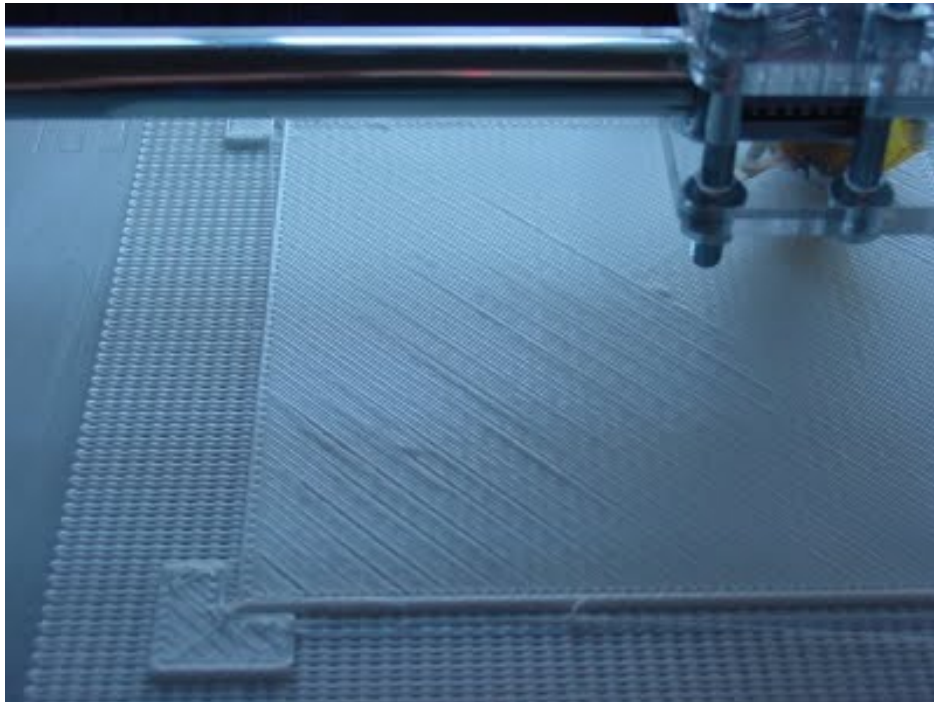
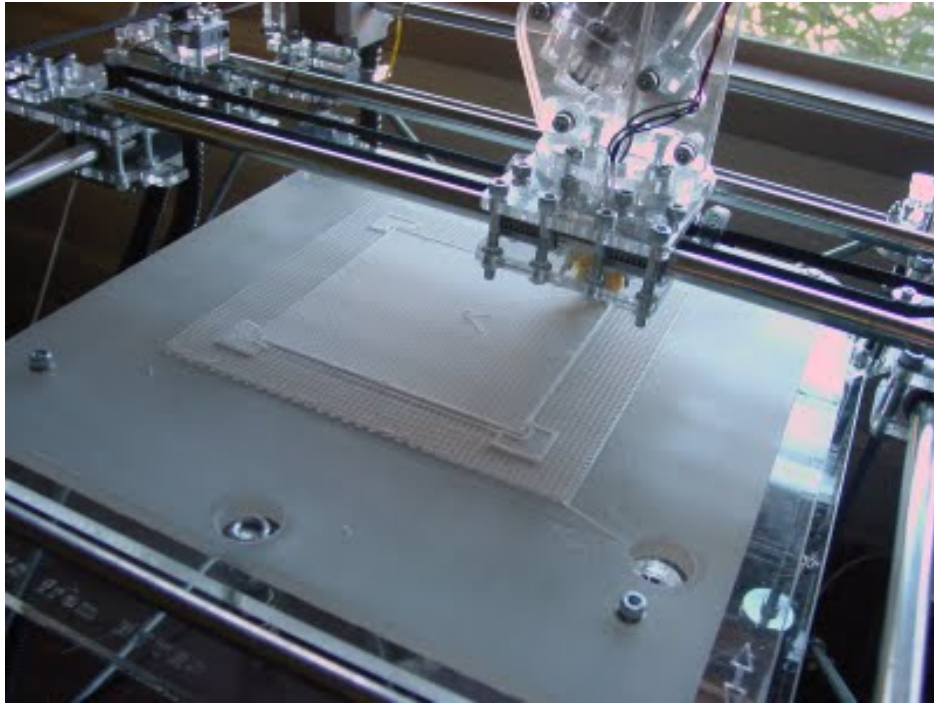

Enrique characterises this as a "hexagonal" fill for reasons that I do not fully understand.

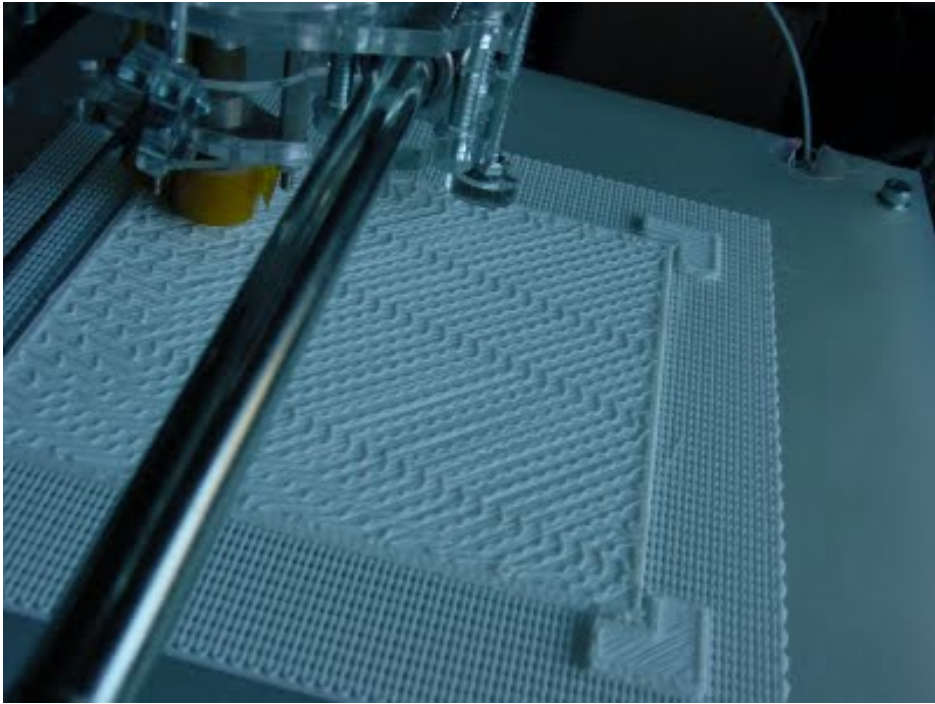

All the same, in the right light the patterns his fill option makes are ravishing.

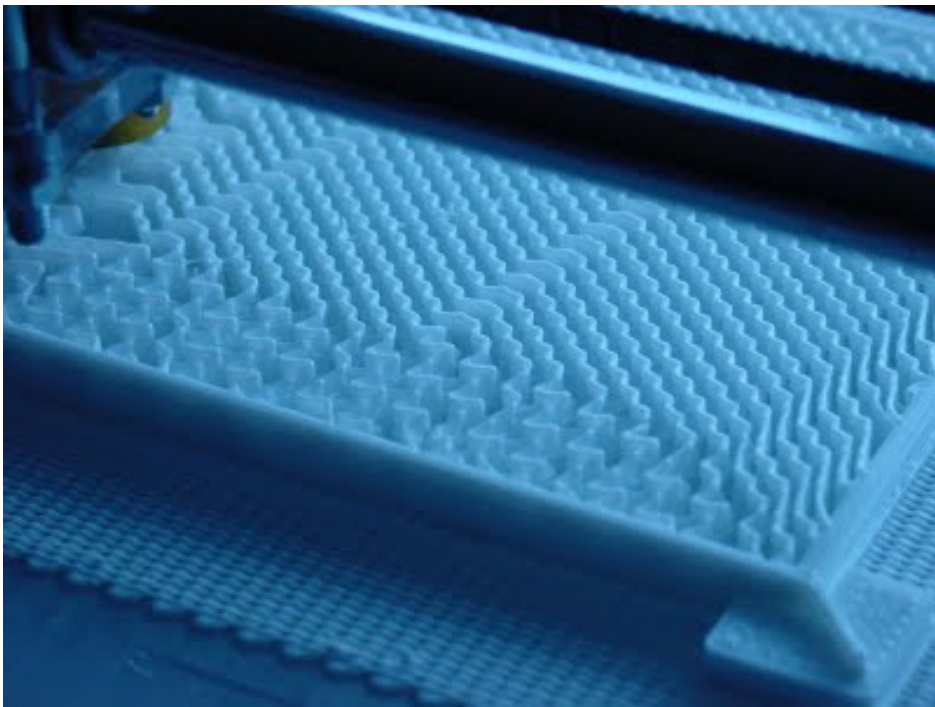

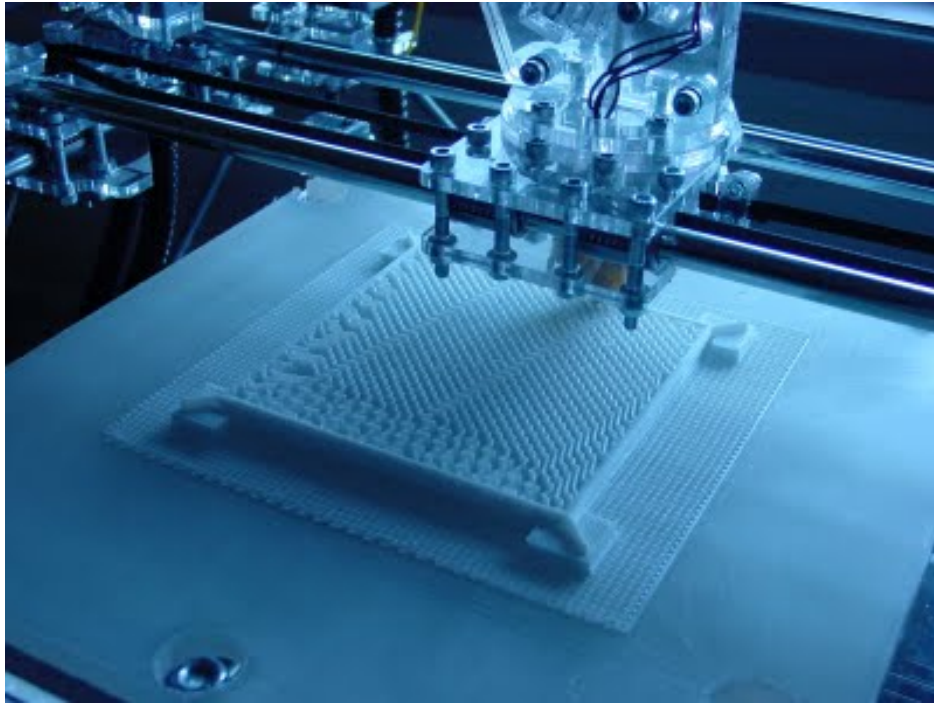

After about five hours the Rapman began to print the top on the block.
[Bogdan's acid test 01](#) from [Forrest Higgs](#) on [Vimeo](#).

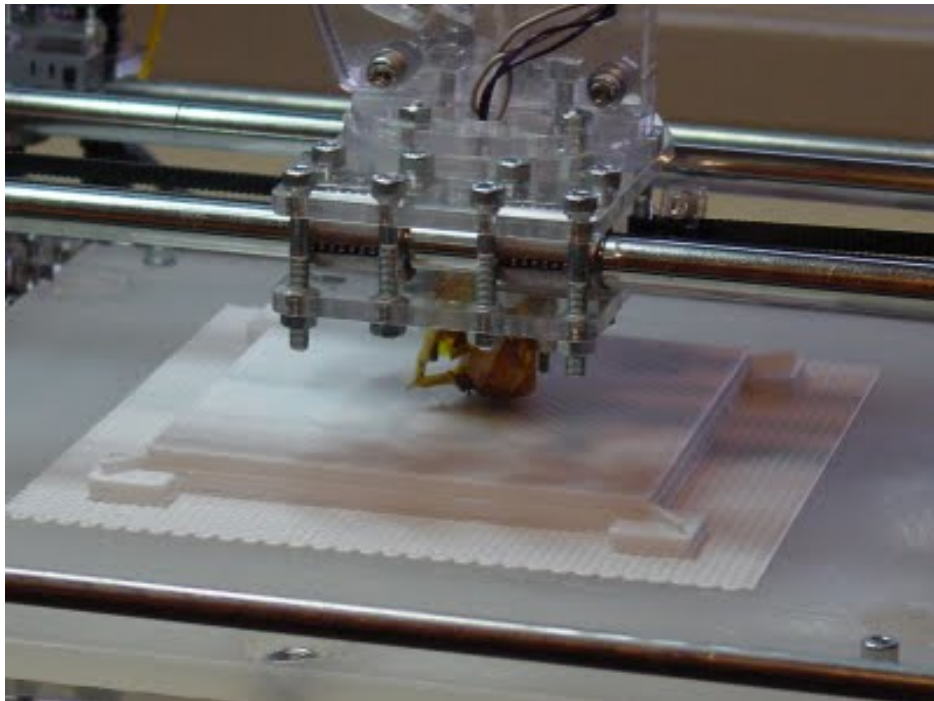

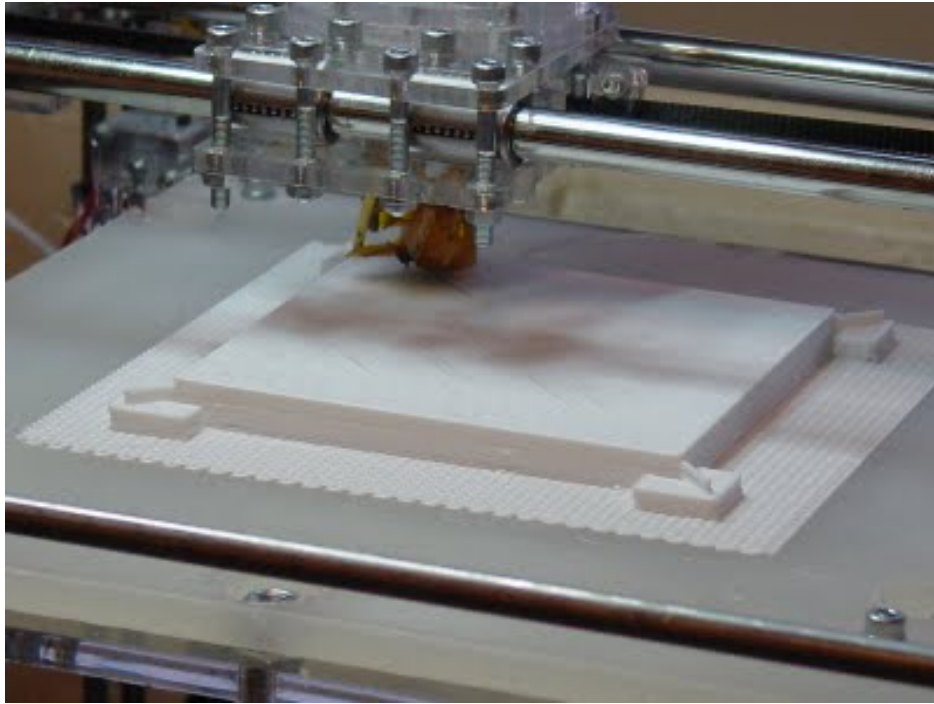

And then it was done.

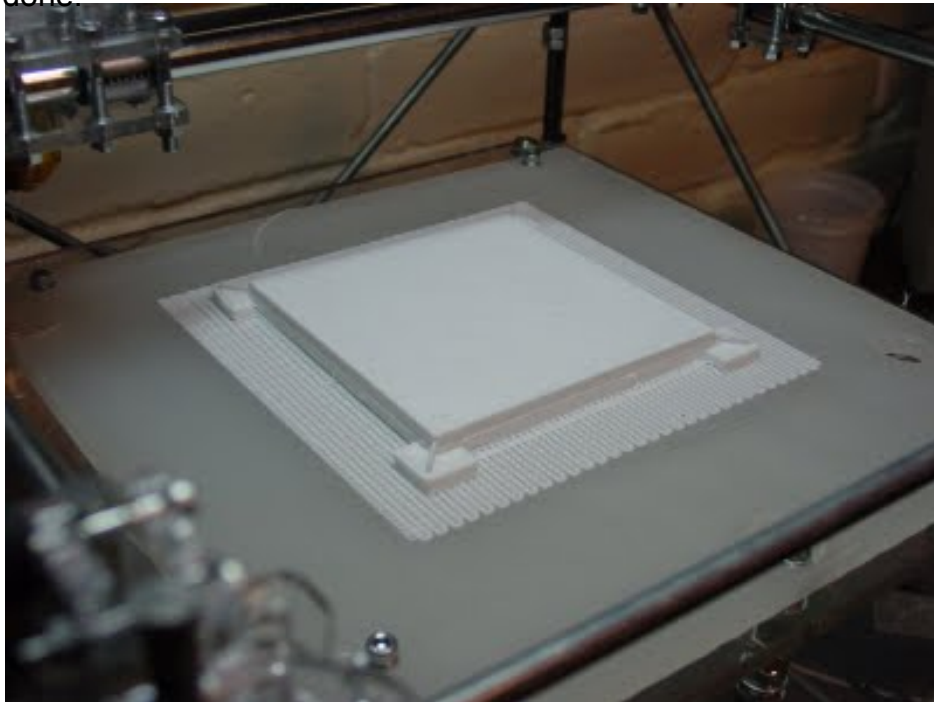

I didn't see the small amount of separation that had occurred across one diagonal until after I began to look closely at the pictures.

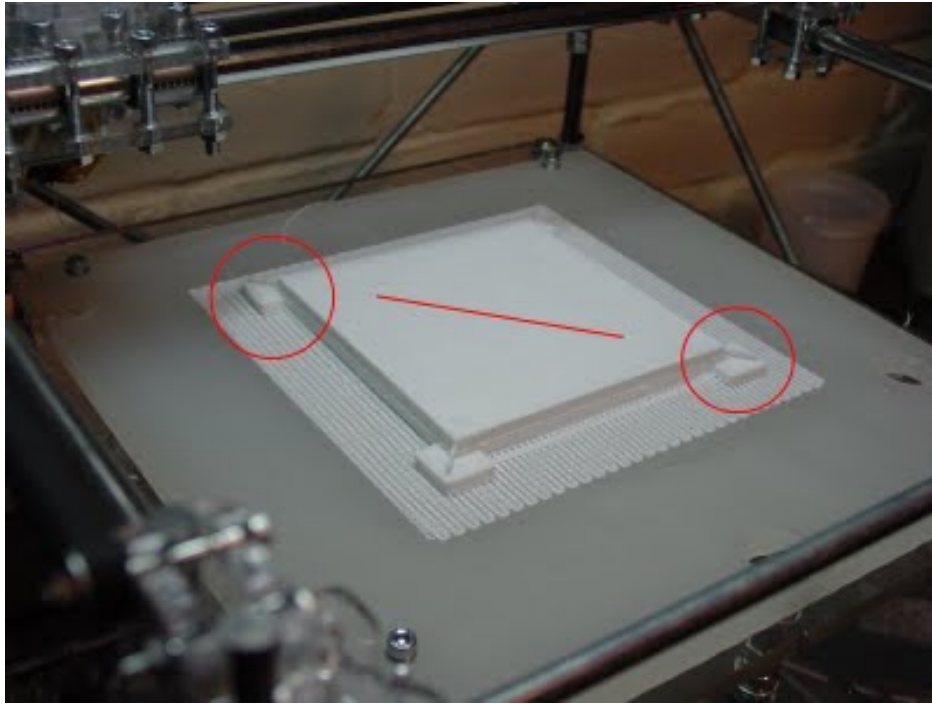

Looking back at the fill pattern what had happened is that the fill created a series of diagonal beams in the block which concentrated tensile stress along that diagonal

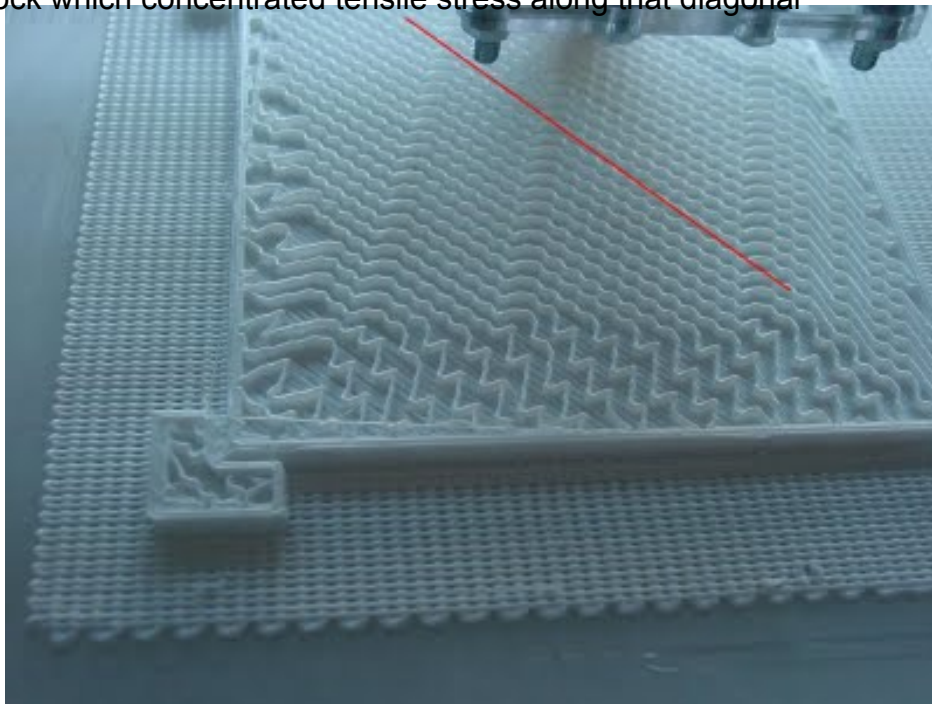

A similar shape is encountered in hyperbolic paraboloid roofs where beams are laid parallel to the perimeter boundary of the roof as in this illustration.

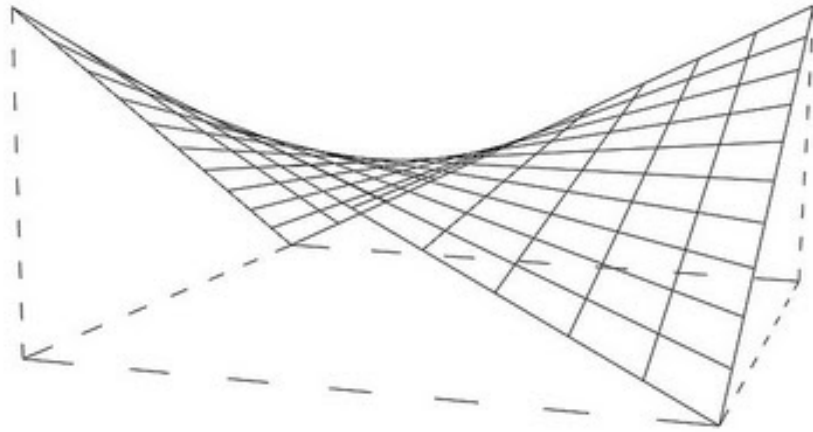

The difference was in our case the beams were laid on a diagonal.

The distortion along the diagonal amounted to about 2-2.5 mm over its 170 mm length. I suspect that I can cure this problem by using a larger tension pad. In the longer run, though, we've got to get a proper hexagonal fill instead of this pretty, but anisotropic pattern that we currently have.

I can't get over how nicely the polypropylene printing surface for HDPE that Bogdan suggested works. I took a short videoclip to show you just how easy it is to get the object off of the print surface.

[Bogdan's acid test 02](#) from [Forrest Higgs](#) on [Vimeo](#).

Please pardon my elbow.

There was no distortion along the perimeter, only along the one diagonal.



Pathetic Fallacy

Monday, 16th November 2009 by Adrian Bowyer

My old Darwin in my home workshop has just finished printing me my personal set of Mendel parts:



Like any proud parent, it was uncomplaining about the chore, even though - for all it knows - it is printing its own replacement.

(I fact I shall keep the old machine so I can double my production rate; and besides it has tremendous sentimental value.)

It's taken me a relaxed couple of weeks, just queuing up prints between experiments, and not leaving the machine running while I was at work. I'm sure it would be OK, but I'm not 100% certain what the insurance company would say in the unlikely event of being confronted by a smoking ruin:

IC: What are all those chemicals in that charred cupboard?

AB: Oh, fertilizer, weedkiller - I do a lot of experiments on plants; various volatile organic solvents. But they weren't the cause.

IC: Uh huh?

AB: No - I have a self-reproducing machine, and I left it running while...

IC: You left a self-reproducing machine running?

AB: Yes, but it's quite safe. It can't reproduce without human assistance, and...

IC: But you left *self-reproducing machinery* running on its own?

etc. etc.

Anyway, now off to hack the documentation as I build...

Making spares for Rapman

Monday, 16th November 2009 by Forrest Higgs

Yesterday, klaszlo, a member of the Rapman users' group wondered how he could get spares for the gear pair on the Rapman 3.0. For many of us, the whole point of Reprap machines is to print our own spares rather than tormenting Ian at BitsFromBytes every time we break something.

Did somebody already designed (ready to print) replacement gears for the extruder?

I think the gears are big enough, that we are able to print them out...

As it developed, nobody had. I wondered how hard an exercise it could be and decided to have a go at it.

I designed the gears as involute profile using a script I wrote some years ago for Art of Illusion rather than attempt to duplicate the spiky ones that come with the Rapman. The pair had a rather odd 14:17 ratio. That done I printed them out in HDPE.



As you can see, the dimensions and tooth counts are the same. In the 14 toothed gear I used depended on a friction fit with a flat side on the 4 mm stepper shaft rather than the grub screw arrangement used in the acrylic original.

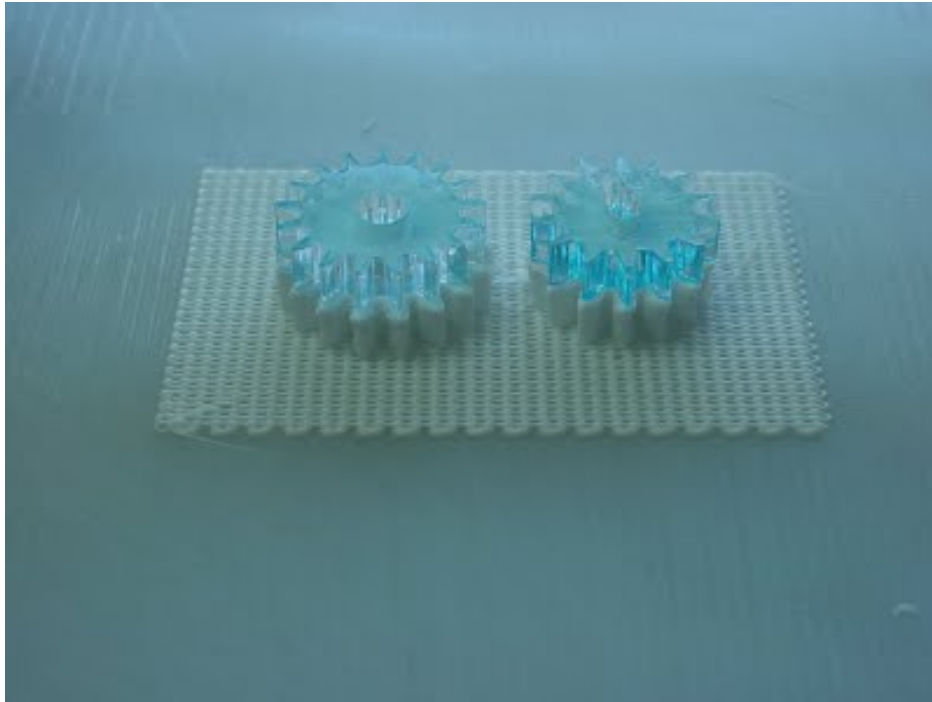

I printed the raft base at 225 C and the second layer of the raft at 230 so that it would stick properly. I also printed the transition layer between the raft and gear at 215 C. I've not had any trouble getting the raft off of the polypropylene print surface. Getting the raft off of the printed part when the transition layer is 225 is nearly impossible, however. The 215 C setting made separating the gear from the raft barely possible. I will be trying lower temperatures to find a sweet spot that makes getting the raft detached workable without special tools being required.



This would probably work better with an 0.3 mm extruder head. I've ordered one, but I am not sure yet how much drama will be entailed in getting it to work with Skeinforge. That exercise got me to wondering how much drama would be involved in getting some of the other Rapman parts printed. Looking at the parts, the extruder seemed to have the most massive pieces. AK47 commented yesterday that the 125x125x10 mm text block that I printed was possibly the largest single piece printed so far. The block is big, but I don't know if it sets any sort

of record. Certainly, Mendel is bound to have pieces requiring more than 59 cm³ of plastic. I grabbed the biggest part of the Rapman extruder and did a tracing of it to get an idea of its dimensions. Here is what it looks like.

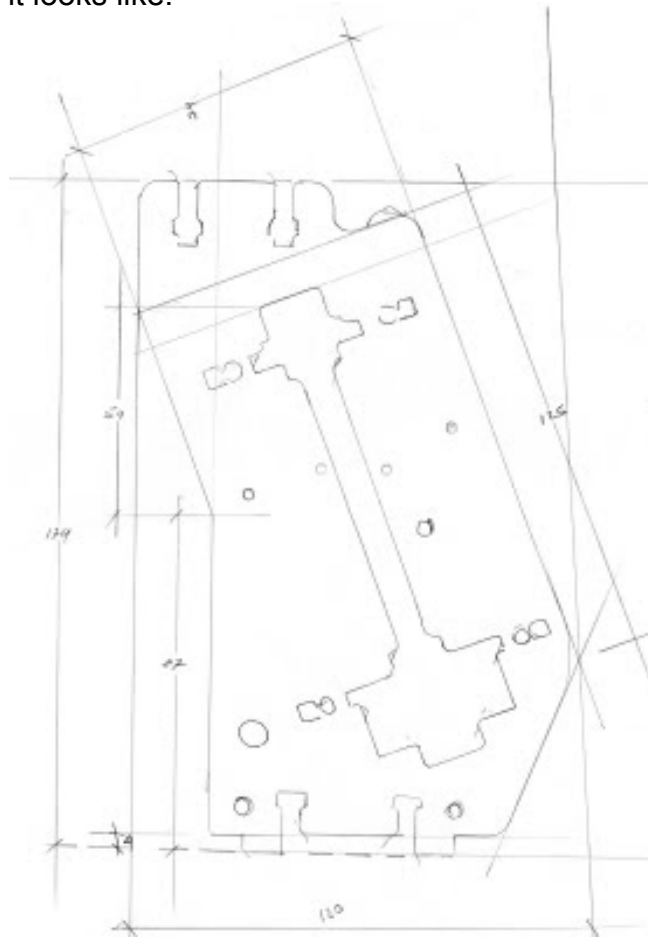

At 120x174 mm it is going to be a bit bigger than the test block we did yesterday and, once we put 15 mm of raft perimeter around it, it will pretty much occupy the whole of Rapman's print surface.

Addendum:

Bogdan suggested that I up the Infill Overlap Ratio from 0.3 to 0.7 to get a better fill into the teeth of the gear.



It does help. You can see the pair with the 0.7 infill overlap at the top.

Moving towards production

Saturday, 21st November 2009 by Adrian Bowyer

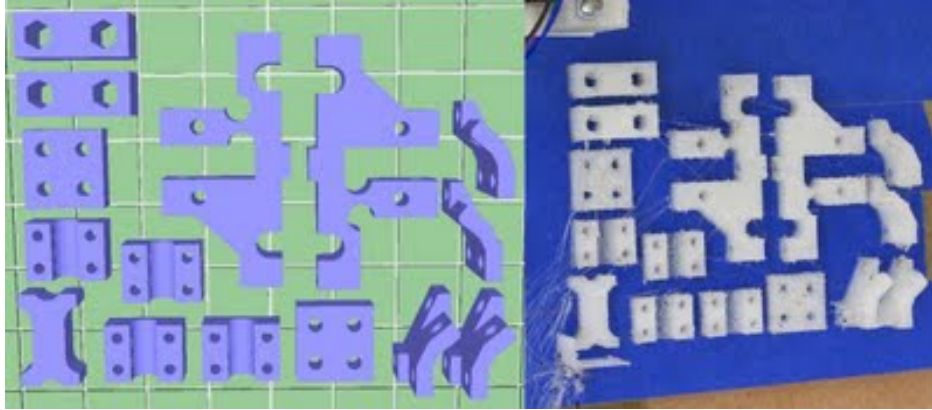

The Java driver software now handles multiple part printing reasonably well, though wrinkles remain. This tray of Mendel parts was printed on my old Darwin in six hours (my new Mendel is still, as web pages say, Under Construction...). Erik and Nophead's experiment of reversing the extrude motor at the end of each write has led to minimal PLA string.

Ages ago Zach defined an XML multi-part file format for RepRap (and Fab@Home) that should be pretty easy to implement that would allow one to store a whole tray of parts like this in a single file. (The G-Code file generated to build all of them is also a single file of course.) I have a few immediate things to do on the software/firmware front (like having an M code that sets the temperature and waits till the extruder gets there, as opposed to returning immediately - one needs both), then I'll implement that. That in turn should mean that Mendel is represented by between four (Mendel) and six (Darwin) files that one just has to load and print...

Mac Goes RepRap (one day...)

Saturday, 21st November 2009 by Adrian Bowyer



Mac|Life magazine recently approached Mark Frauenfelder and others to envision a future product from Apple. Mark's entry was based on RepRap (left). [More details here.](#)

Of course, if Apple do that, they'll have to GPL all its designs.

And I'm guessing it'll be a RepStrap, not a RepRap...

Bugs Brew PLA Direct

Tuesday, 24th November 2009 by Vik Olliver

A team from South Korea's KAIST University and the chemical company LG Chem, have developed a one-stage process which produces our favourite fabrication material, polylactic acid, and its copolymers through direct fermentation of starch. They've genetically engineered *E.coli* to do the job, which makes the production of PLA cheaper and more "commercially viable."

There are undoubtedly patents on this, and I don't know how the separation process works, but cheaper biodegradable feedstock for the current generation of RepRaps and the ability to basically brew the stuff in a vat will doubtless have an impact on both RepRap technology and our greed for oil.

Vik :v)

The March of the Mendels

Tuesday, 1st December 2009 by Adrian Bowyer



There are two machines coming together in the Bath University RepRap Lab, and I am building a third at home. Here they all are together with the Mendel prototype that made many of their parts (the rest were made in our Darwins). It's almost as if they are reproducing or something...

Soluble Support Material

Wednesday, 2nd December 2009 by Rhys Jones

One of the big things that we've wanted to get working for a while is support material. Whilst we have a lot of the features required for this in the host software, we still haven't found a suitable material.

But where can we get a material that is readily available and cheap? It seems even ABS filament is pretty hard to obtain. Given Zak's recent success with his paste extruder, I thought the best thing to do was have a go at making a paste using some off the shelf items.

The paste we came up with was based on chalk (we actually used pottery Whiting from the local pottery suppliers that cost a massive £0.67/kg), Ethanol and some PVA Glue. We also used some fancy additives (PEG and Methyl Cellulose) that are typically used in making pastes, but we think we can get rid of these as they didn't have a massive effect.

Anyway, the final mixture seemed to take a while (at least 15 minutes) to set, but I wondered whether the surface tension and viscosity of the paste would be sufficient to support the usual build material. I created a small block with a shallow hole that didn't travel through the complete extent of the part, and then built the part with the orientation such that support was needed. I stopped the build at the appropriate point, deposited some paste in the hole before continuing the build. Here is the result:



The paste washed away after about a minute when being held under cold water, and it looks like the heat of the plastic was sufficient to cure at least the outer layers of the paste. It's hard to tell in the photos, but the inside of the hole looks a little messy. I'm not sure if PLA is slightly soluble in the fumes of the Ethanol as the paste sets. It definitely smelt a little weird but I can't find any data to prove or contradict this suspicion.

A massive thanks goes out to Andrew Dent from the University of Bath materials lab for giving me a hand with all of

this.

Edit:

Nophead rightly points out in the comments that this test wasn't entirely fair. The above part could be created anyway by adjusting various parameters. Here is something a bit more fancy:D

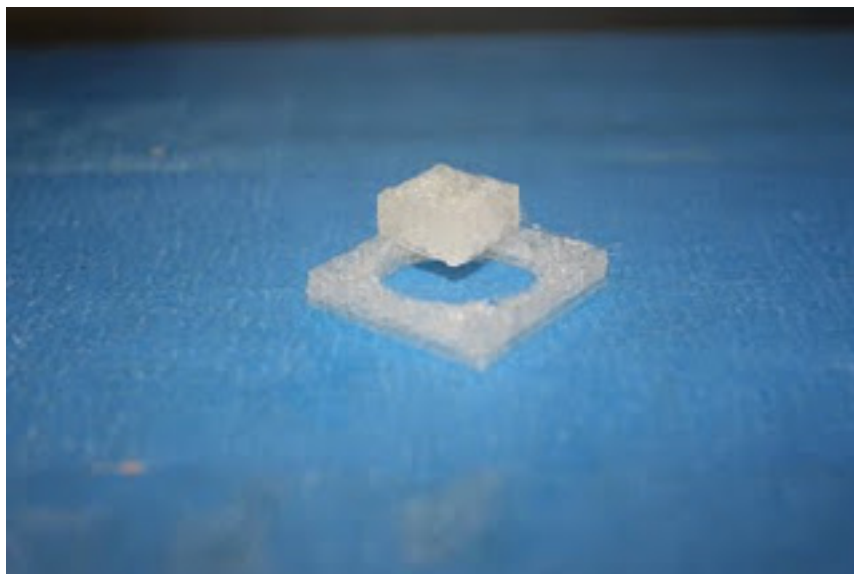
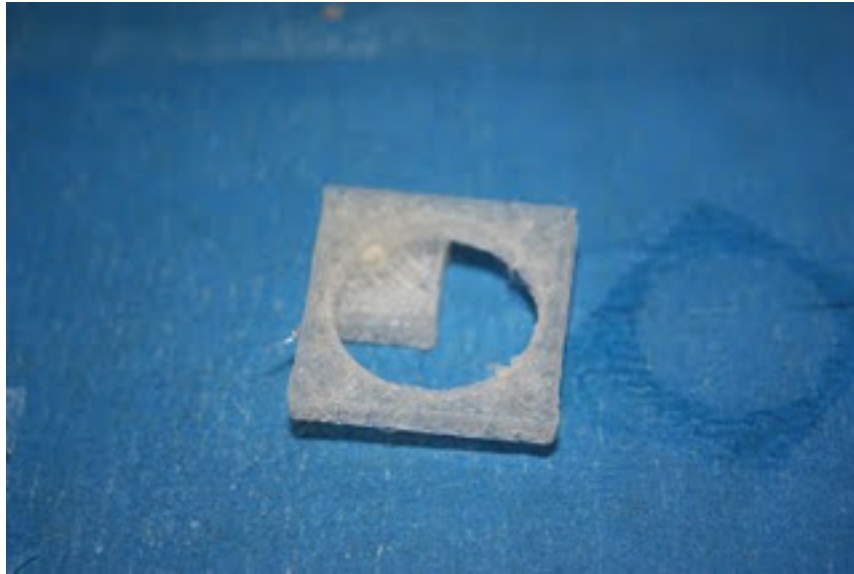

It's apparent that the paste was not completely set as the overhang sags a little bit.

Higher quality pics are available [here](#)

RepRap Goes To School

Friday, 4th December 2009 by Vik Olliver



The boys & girls of Mrs Cornwell's class at Oratia School in Waitakere were kind enough to invite me along today to help with their topic of inventors and inventions. Hello room 16! I took the RepRap Child along for its first day at school, and we made a Mighty RepRap Power Ring. I left them with lots of small samples, some Polymorph to create their own inventions with, and a Christmas Angel to put on their Christmas tree. I'm sure I spotted one or two budding inventors and inventrixes there!

Vik :v)

Metal bits from a RepRap

Saturday, 5th December 2009 by Vik Olliver

OK, so as always I cheat a bit. I used the ancient art of lost-wax casting, substituting PLA for wax. It burns/vapourises away cleanly at low temperature and is relatively benign stuff. So, how do you go about turning your PLA RepRap output into metal?

I took one standard-issue Mighty Reprap Power Ring in PLA as a test subject, and stuck on a few bits of 3mm PLA where I thought it looked useful. At the highest point, I stuck a simple printed cone of PLA to act as a filling hole. Then I painted it with thinnish plaster of Paris mix. While that dried off a bit, I mixed up more plaster and snipped into it about 30cc of uncompressed household fibreglass insulation. They only need to be about 5mm long, and are mixed in to disperse as well as you can. This will help stop the mould cracking (or, more to the point, hold it together if it does). This stiff mix is packed smoothly around the object, taking great care to not trap air bubbles like I did.



I wrapped masking tape around the bottom of a jar (initially sticky-side out) to make a disposable paper casing for our test subject. It looks black in the photo 'cos it's well-baked. Then, a couple more spoonfuls of plaster bedded said plastered bundle into place in this little paper pot. The pot was dried overnight in a desiccator, then baked at 150C for 15mins to drive off moisture. Next, the pot was inverted over a wire stand and foil drip-tray - out of deference for me not being in trouble for mucking up the oven. The temperature was raised to a scientific "11", and stayed that way until the conical filler hole looked absolutely clean, though slightly browned.

During that time, I fired up the ol' furnace (renewable fuels, etc.) and melted a load of pewter. With the mould still really hot (and thus safely dry) I poured in the pewter and left it for a 1/2 hr or so to cool off gently. I definitely did not impatiently have-to with a can of "Freeze Spray."



With the aid of tongs, the flat side of a 160g pein hammer was strategically deployed multiple times (Adrian will remember my skill with this tool from an earlier occasion) to reveal an amazingly faithful reproduction of the ring. The pegs sticking up are where pewter got into the vent holes. You want this to happen - just trim the excess off and file down. Same goes for the filler hole, just pop the scraps back into the clearly-labelled "Scrap Pewter" box.



After a stiff brushing under hot water, I was allowed in the house - no, I mean the ring was cleaned up and presentable. An air bubble was trapped inside the ring, resulting in a blister of pewter. But pewter is soft stuff, and you can easily correct problems like that with woodworking tools and a file.

If you do all this, do take basic safety precautions. Also be wary of using metals that melt at a higher temperature like aluminium. They cause plaster of Paris to decompose in undesirable ways and you need to research it properly.

Vik :v)

Can we print belts?

Saturday, 5th December 2009 by Forrest Higgs

Yes, if we step back and look at what a belt does instead of simply trying to replicate existing ones.

Belt driven Reprap machines have always bothered me. They're fast and now that the price of NEMA steppers is getting reasonable, they're even becoming economical. It bothers me, however, that the belts and sprockets can't be printed very easily.

Last night I was cleaning up a corner block that I'd printed and was cleaning out a bearing seat with my Dremel tool fitted with a cylindrical abrasive head. These are a nice little fitting that lets you slip what is a cylindrical piece of sandpaper onto your Dremel. They are cheap and very effective.



I was looking at it when I realised that the toothed belts are toothed to prevent slippage and that there are other ways to prevent slippage than teeth. An abrasive cylinder, for instance. With an abrasive sprocket you wouldn't need teeth and the belt wouldn't need teeth either.

It was a matter of a few moments to design a 600 belt in Art of Illusion that would easily fit on my Rapman print stage.

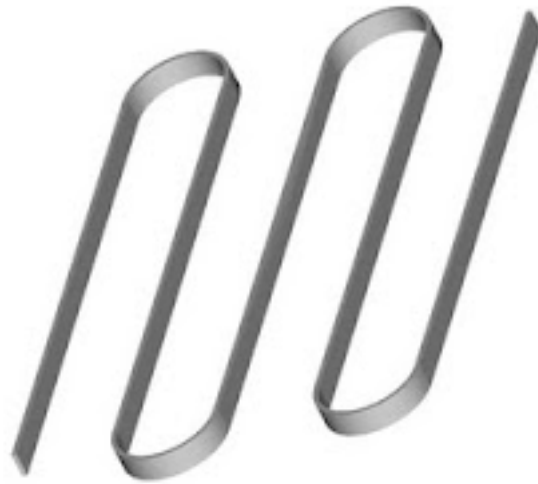

A few minutes more and I had it run through Skeinforge and printed it in HDPE.

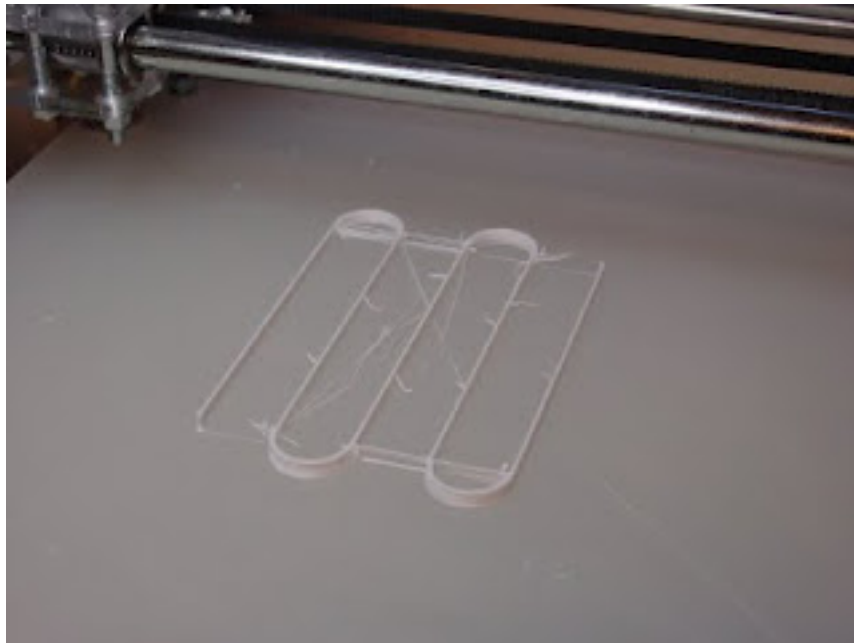

Cleaning the belt took a few minutes, not no big deal.



The resulting belt is very flexible and quite strong.



I've got a pile of NEMA 17s. I might just print myself out a Mendel now. Mind, I will be using my OWN electronics.

Killing flocks of birds with one stone

Saturday, 5th December 2009 by Forrest Higgs

I've got the curling on HDPE prints down to something quite manageable. Last night I decided that I could dress down the remainder if I only had a belt sander. A little while ago, I went into town and bought a nice little Makita belt sander. It wasn't the cheapest, but it would lay, belt-side-up, quite firmly, which is what I needed.

It took about 15 seconds to grind the raft off of Bogdan's corner block for Rapman and dress off a few other rough places



I bought a new little drum sander for my Dremel {~\$4.50} and cleaned up the seating for the z-axis bearing.



It also did a nice job cleaning up the hole for the z-axis threaded rod



One added benefit which might be the Rapman or might be the HDPE or might be the Skeinforge settings is the roundness of the horizontal holes in the print.



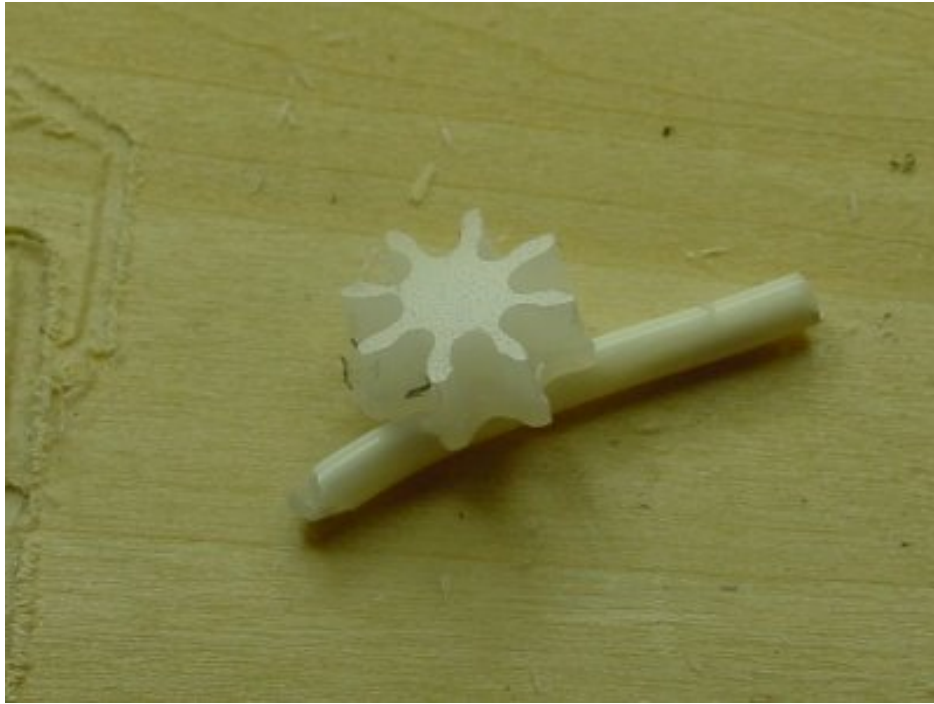

None of this teardrop nonsense.

I'm beginning to think that HDPE is a very serious contender for printing Mendel parts. It's dirt cheap, readily available, strong, doesn't make nasty fumes AND now we know how to work with it. I expect that polypropylene, which is cheaper still is going to be just about as good.

Now here is the serendipitous Christmas present. That Makita belt sander grinds HDPE a treat and puts it in a little bag, or a big one if you want to sew one.



Guess what? The problem of grinding plastic so that it can be recycled into filament has just gone away. Virtually any kind of extruder can eat plastic powder. It takes a heftier one to use 3 mm pellets or shreds of a similar size.

Build yourself a slope-sided hopper on top of that Makita and your grinding problems are solved. When you wear out your belt, go down to your hardware store and buy another. The Makita uses a 3" x 18" belt and it costs a bit over a dollar. No difficult-to-sharpen, never mind dangerous, macerating blades.

God Jul, everybody! :-D

RepRap'd Art Exhibition

Monday, 7th December 2009 by Vik Olliver



Image not found.

I'm very happy to announce the opening of an exhibition of RepRapped artworks collated by Bronwyn Holloway-Smith, Rhys Dippie and myself. The exhibition is at Massey University in Wellington, New Zealand. Most of the 10 exhibits are resurrections of lost items from the Te Papa collection. It was great fun setting this one up and my particular thanks go to Bronwyn for setting everything in place.

The sperm whale's tooth in particular has a curious aesthetic charm, and the tapa beater is the largest thing I've ever seen RepRap'd.

Vik :v)

Got it!

Tuesday, 8th December 2009 by Forrest Higgs

Got it!

Tuesday, 8th December 2009 by Forrest Higgs

I'd heard that people printing Mendel were having trouble printing the largest pieces of Mendel in anything but PLA. Since PLA filament is hard to acquire in the US at this point I thought it would be nice if those hard-to-print parts could be printed in some other plastic. Since I am working with HDPE right now, I decided to have a go with HDPE.

The trial part I've begun with is x-carriage-lower_1off. I've discovered that a segmented apron positioned 0.5 mm away from the perimeter of the part does the job of successfully suppressing warping. Here you can see the spacing between apron and part.

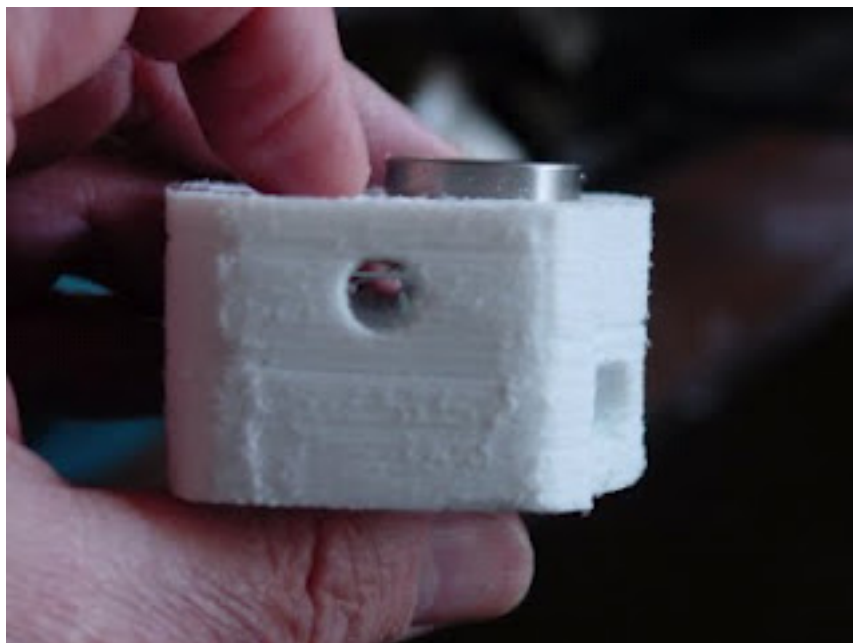

Here is the completed print.

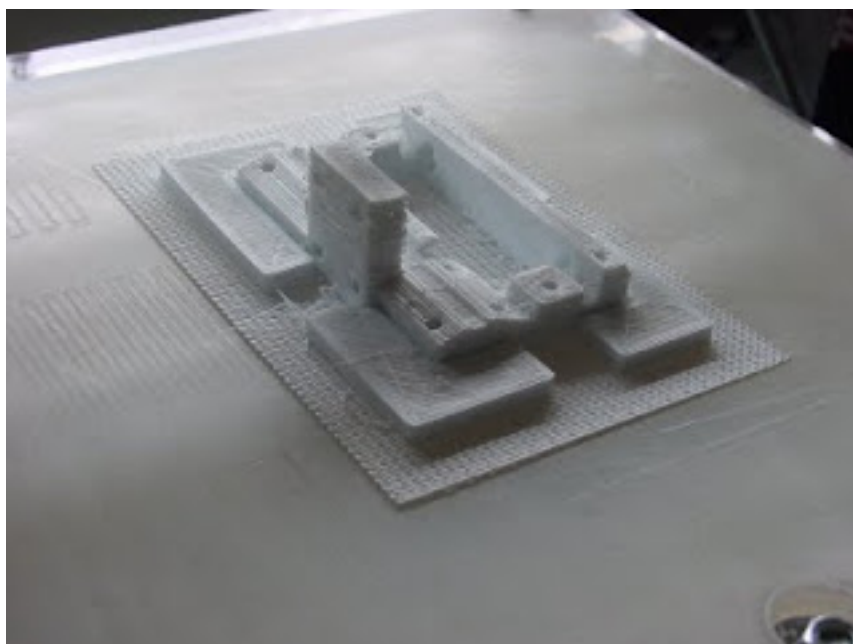

I've cleaned off a bit of the strings. I understand that the newest Rapman firmware release pretty much gets rid of strings. I haven't taken time to install it yet, though. There was only one instance of corner curling.

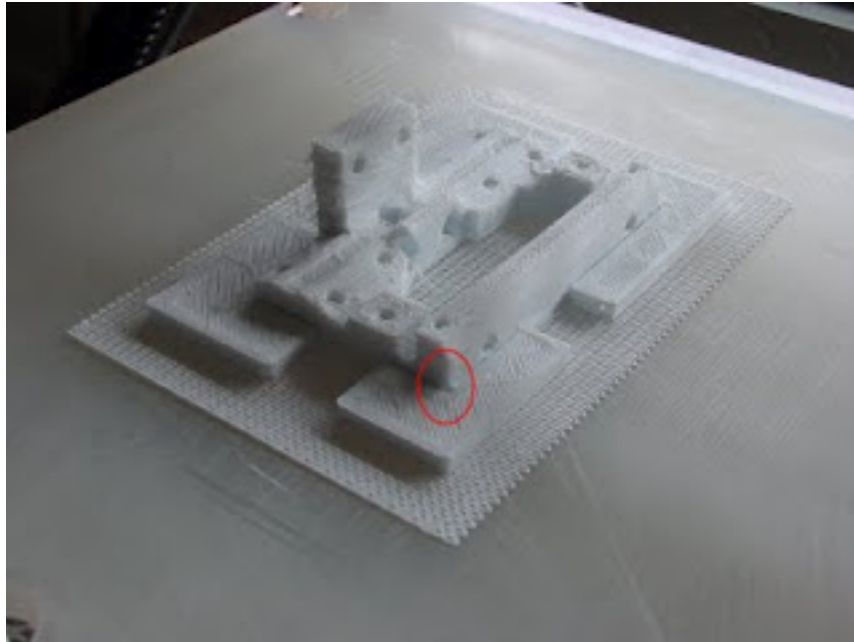

I've circled the corner in red. The curl amounted to about 1 mm. Belt sanding leaves you with a flat bottom to your part. The fill was raft material. I got the part out of the the apron and off the raft with my belt sander.

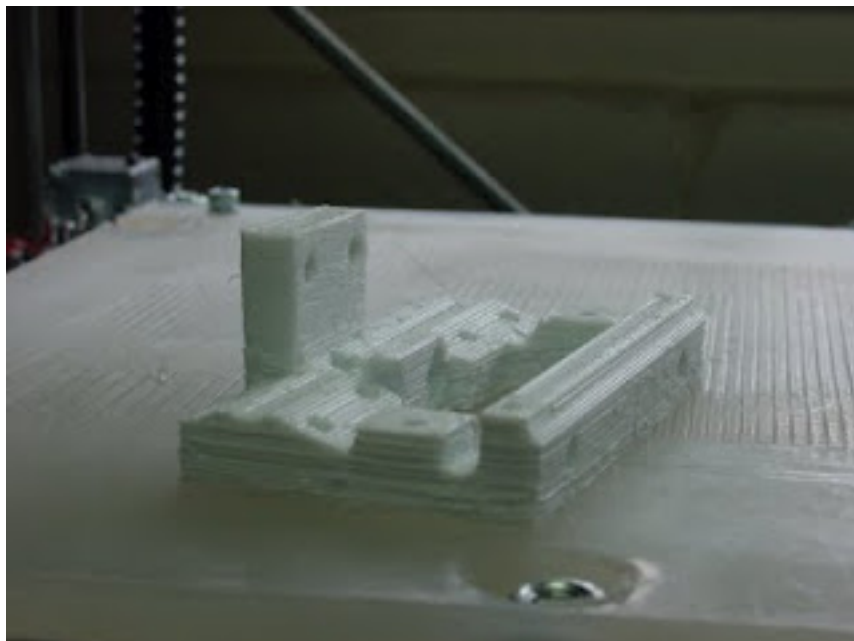

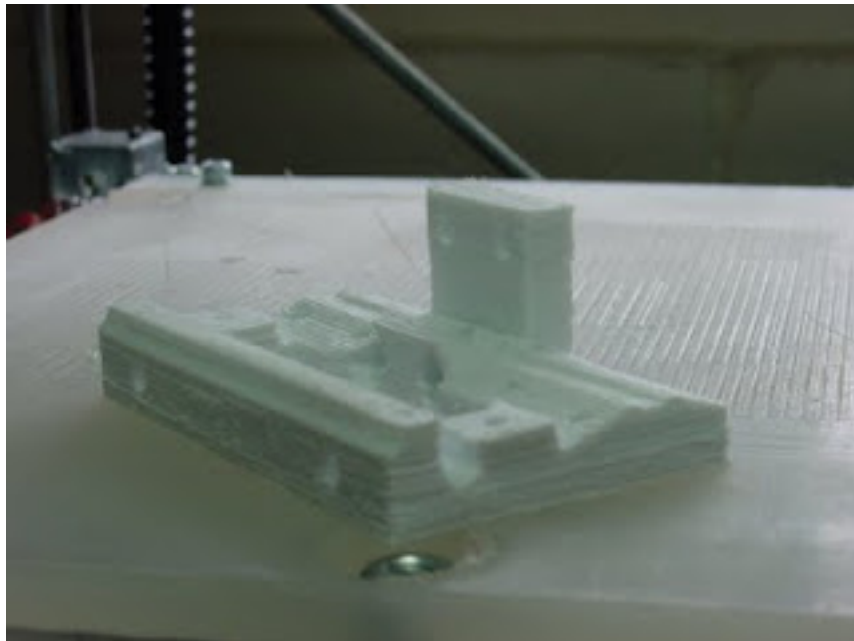
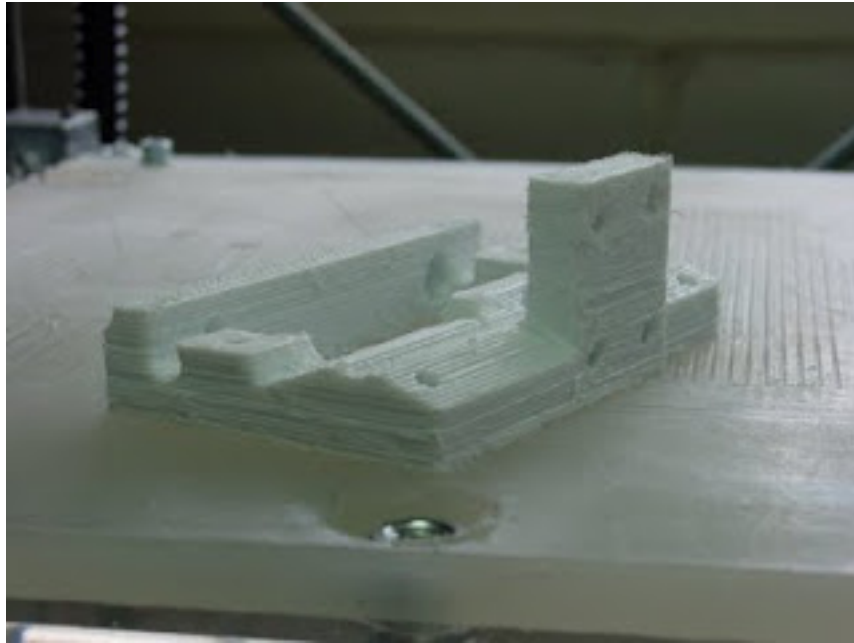

If you want to print this on your own machine you can download the STL for the part combined with the segmented apron here. I made no changes to the part save adding the segmented apron. I had to rotate the original part to work on my Rapman 3.0. You may have to rotate it again to get it to work on other Reprap machines. I would appreciate hearing if this approach works for ABS. I have ABS here and could try it, but I want to see if I can apply the same technique to do what I understand to be the other big Mendel part, viz, z-lead screw base bar clamp_2off.

z-leadscrew-base-bar-clamp_2off

Wednesday, 9th December 2009 by Forrest Higgs

I treated Mendel part z-leadscrew-base-bar-clamp_2off in the same way, viz, a segmented apron. You can see what this looks like in Netfabb.

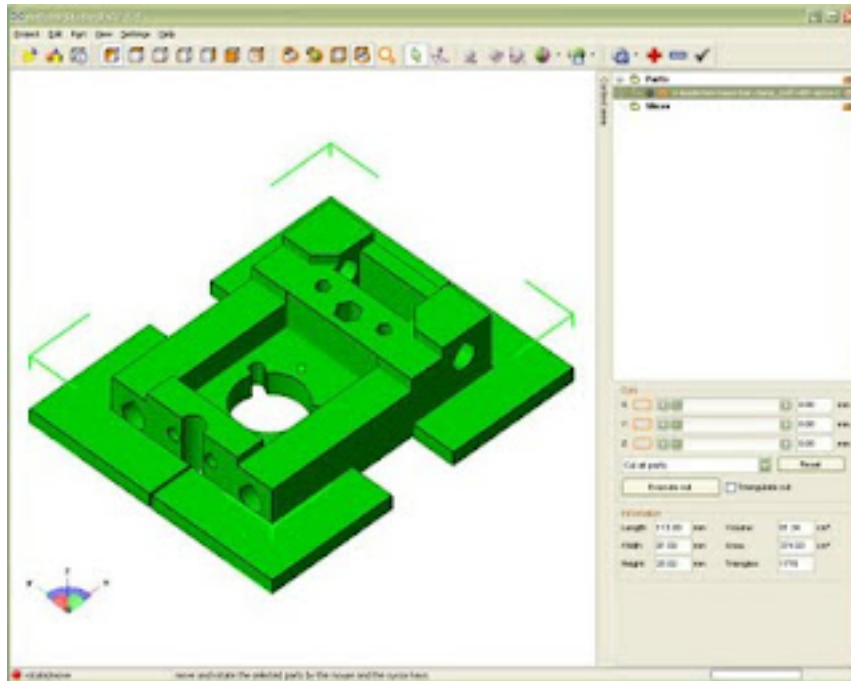

As printed, the part looked like this.

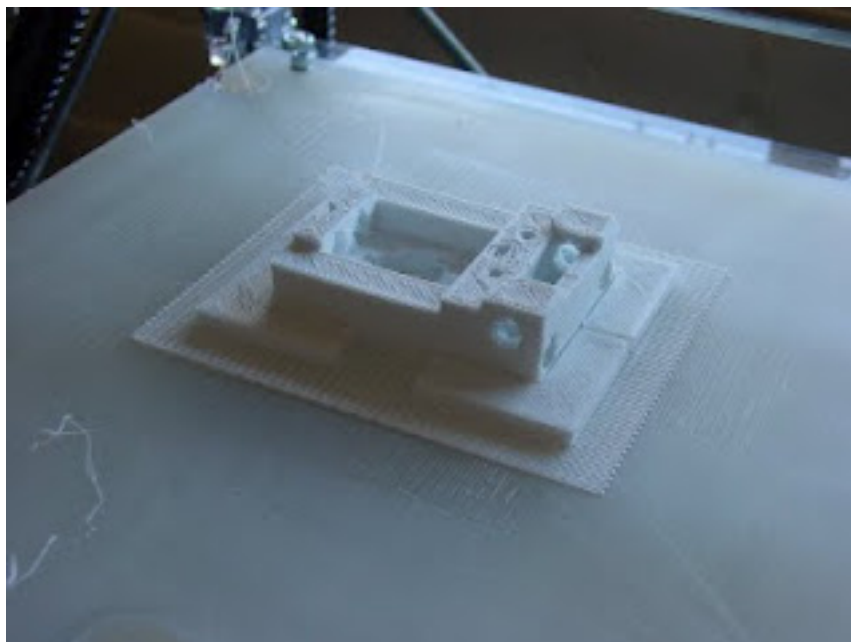

Cleaned, it looked like this.

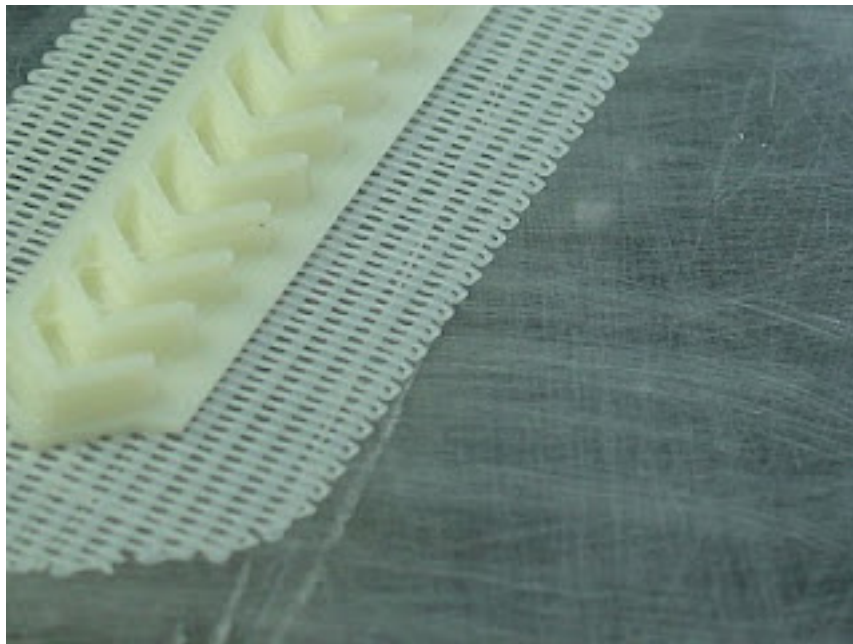

There was a very mild bit of curl on the right-hand edge {~0.5 mm}.

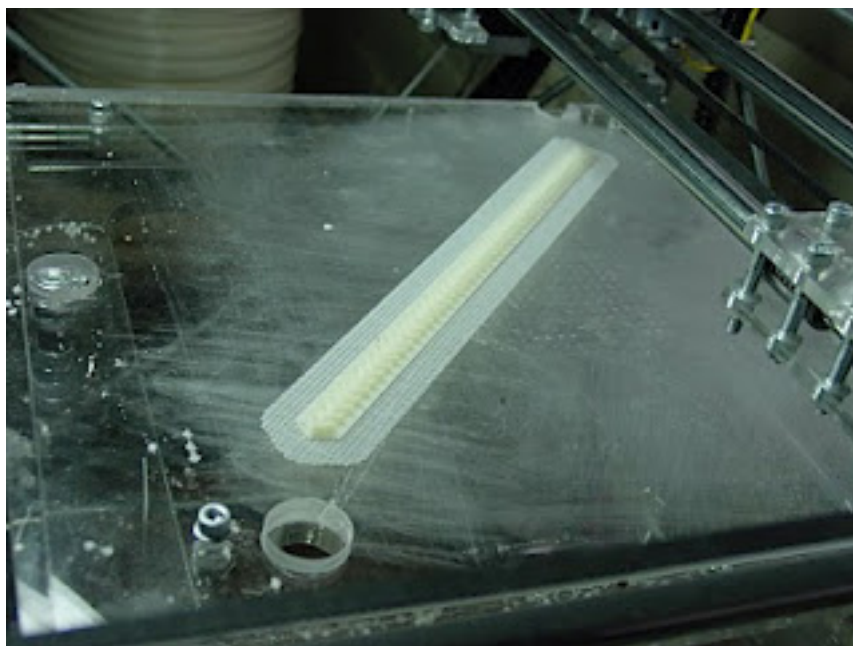

There was a small problem in that the near side of the part tried to delaminate. The part has two horizontal holes that run the length of the part.



I think, perhaps, that the settings that I am using with Skeinforge didn't get me a proper fill there. More to the point, as I learned eons ago as an architect, it's much easier to design a part than it is to design a part that you can build. For HDPE, it seems to me that if this part was maybe 4-5 mm wider leaving the longitudinal holes in the same place, this delamination wouldn't have occurred. Mind, it may not be a problem with PLA and ABS.

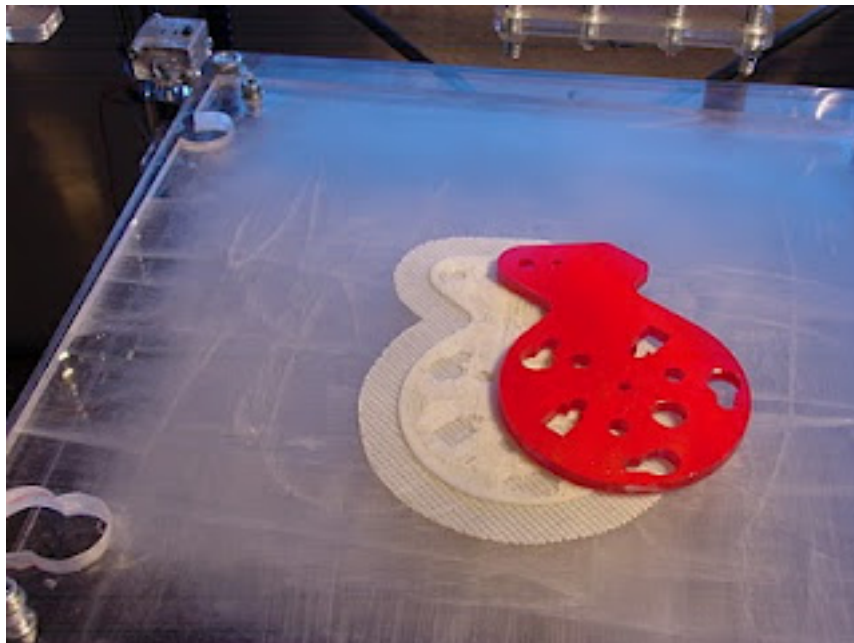

Other than that, no problems.

If you want to play with this part associated with segmented aprons, [you can get the STL file here.](#)

Several people have complained that they can not get the x-carriage-lower_1off part to print in ABS. I've rerigged my Rapman 3.0 for ABS and am attempting to print it now. I hate the stink of ABS.

ABS works, too.

Thursday, 10th December 2009 by Forrest Higgs

Segmented aprons work just as well in ABS as they does in HDPE. I didn't even bother changing the Skeinforge settings. Just make sure that the first layer tracks for your raft measure 2 mm wide {so that it sticks to your acrylic print surface} and you're good to go.

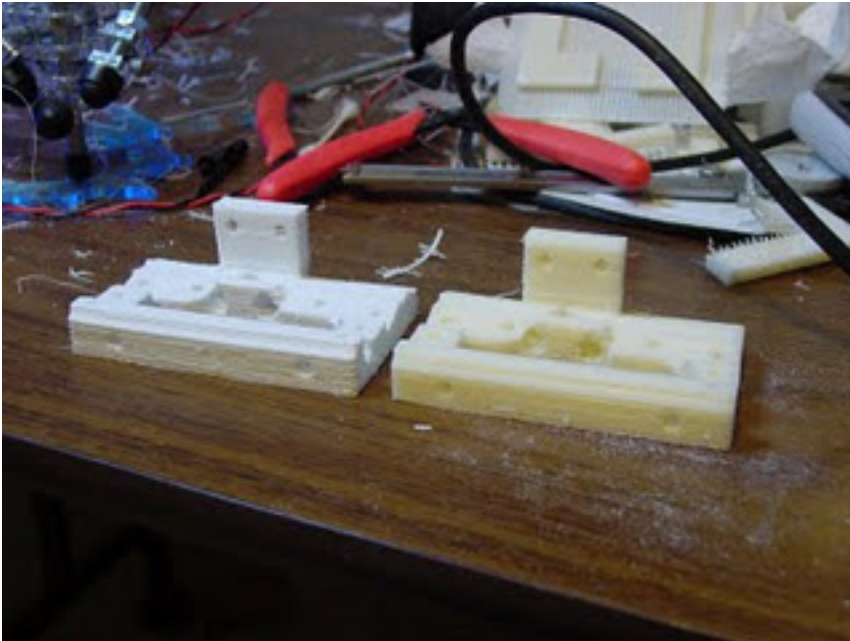

Mendel part x-carriage-lower_1off in HDPE {left, white} and ABS {right, amber}

[You can read a little bit more.](#)

Brute force stepper controller

Friday, 18th December 2009 by Forrest Higgs

Back in 2005-6 Reprap was using the venerable Pic 16F628A and was controlling steppers with the old, but reliable SN754410 chip.

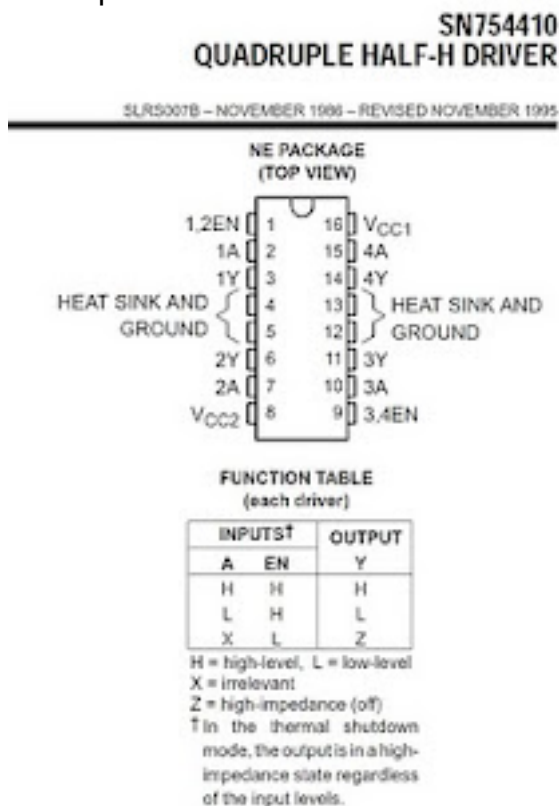

The SN754410 is a very nice little chip. It is DIP, easy to use and very reliable. The only real problem with it was that you couldn't run more than 1.1 amps on one of them continuously. Simon McAuliffe, a Reprap core team member from its modest beginnings in 2004 solved the capacity problem by stacking one on top of another. While this worked, it created a rather nasty soldering problem for people like me who lack good fine motor control.

In those days we were using stripboard, known in the UK as Veroboard after it's original source.

Stripboard is a wonderful development system for DIP chips. Unfortunately, it was hard to get in the US, a Velleman Euroboard costing anywhere from \$6-15. As time went on, Reprap went more and more over to designing boards with Eagle and sending them off to lithography shops. Once there, it was only a matter of time before surface mounted chips began to creep onto the boards. Surface mount is a whole other chip packaging technology which caters to automated circuit board production. It is a bit difficult to make surface mounted chip boards, especially for clumsy oafs like me. As a result, I stayed with DIP technology, suffering considerable derision by other Reprappers as a result. My point was simple, however. I felt and still feel that if a bright 12 year old can't master the technologies and techniques needed to make a Reprap machine, we're not going to see viral diffusion of the Reprap technology.

Last year, I found a cheap supply of stripboard in the US. Once I had a cheap supply of stripboard, I looked around for a nice, open source design tool for putting circuits on one.

Unsatisfied with what was available, I developed my own.

Last week, having got a grip on how to run my Rapman 3.0, I decided to look at developing the controls for a next generation stepper controller. I ordered a bunch of the cheap stripboards...



...to make sure that the web advertisement wasn't a fluke. The boards are quite high quality, made in Taiwan.

Once I had those in hand, I decided to leverage the work I'd done with I2C coms last year and design a high capacity stepper controller board. To keep things simple I took a page from Simon's book and decided to simply keep adding SN754110 chips till I had the amperage capacity I needed. I wanted the design to run a NEMA 17 {I own about a dozen} that I'd bought at the beginning of my involvement in Reprap. It draws 2.4 amps, so I needed three SN754410. Here is the design I've developed so far.

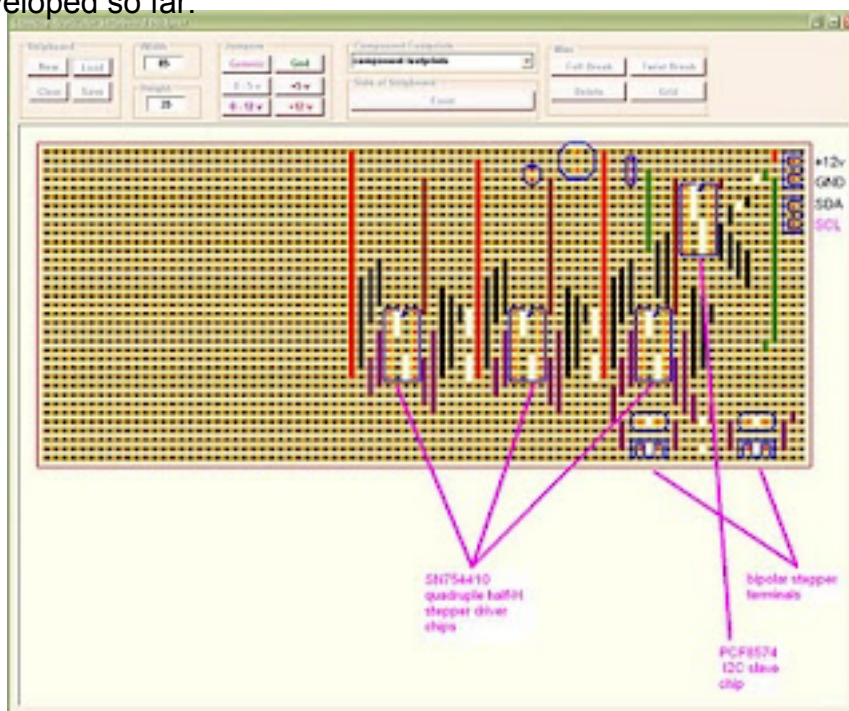

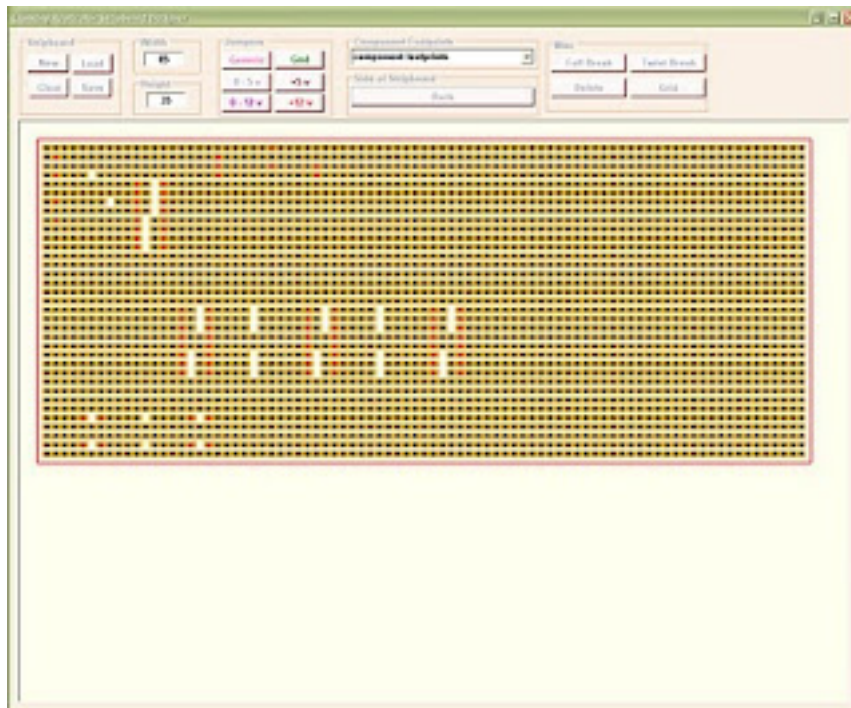

While I've configured this board for 3.3 amps capacity, it will easily seat another 2.2 amps of capacity. The circuit design is extremely repetitive. I got the thing built and the circuitry debugged last weekend.



It has been a while since I built up a board, so I blew up a few chips until the drill of checking every circuit trace for continuity and checking again and again for shorts caused by sloppy soldering came back to me. I found that putting a washrag over the board when I powered up contained the fragments of exploding SN754410 chips. In testing, I have been able to get a small, half-amp tin can stepper to run at speeds of up to 830 Hz. I seem to be able to run the NEMA 17 at about 4 KHz at full step. Mind, that is an estimate from my timing cycle and is probably on the overconfident side. I still haven't found the bug in the firmware that is causing problems with directional control. In passing, the three SN754410 controller chips stabilise at about 90 C when running the NEMA 17. I haven't decided whether I will glue heat sinks on top of the controllers or bring the temperature down by adding another controller chip.

New Year New Plastic

Friday, 1st January 2010 by nophead

I managed to extrude PMMA (Acrylic) :-



But only with a heated bed.

A printable, high speed alternative to belts?

Thursday, 14th January 2010 by Forrest Higgs

Years ago, I created Aol scripts to design involute profile gears and racks. Recently, I've been exploring the notion of using rack and pinion drives instead of belts. While it is relatively easy to design and print a rack and pinion gear set, conventional ones have a problem with lateral stability.

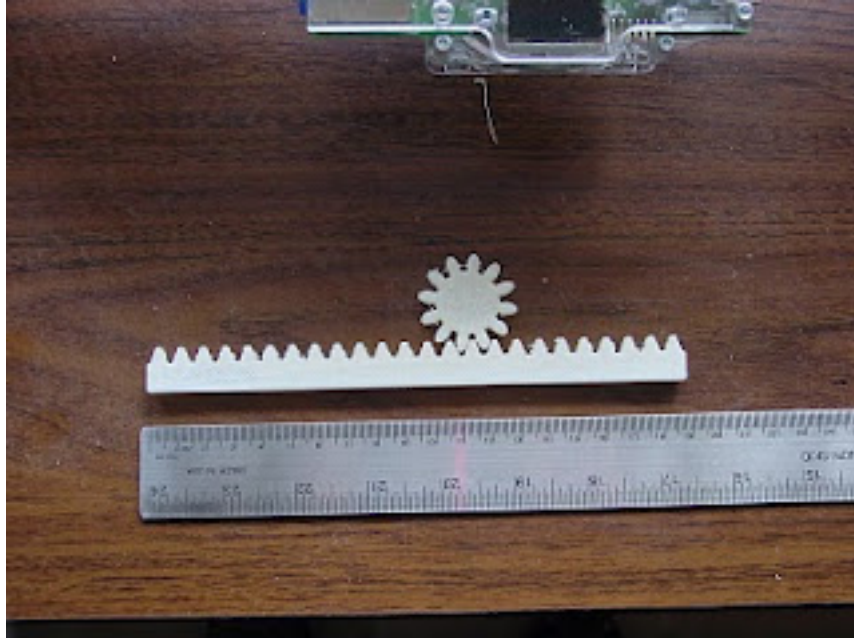

I soon found that I was buying far too many skateboard bearings to make up for this problem than was sensible.

A month or so ago, I ran across the idea of herringbone {double helical} racks and gears.



You don't hear too much about this kind of gear and rack mostly because it can't be machined with

conventional hobbing machines. It can, however, be printed relatively easily. I found that I could coax my extant rack and gear scripts to produce such components



I was at, however, pretty much the limit of what Art of Illusion could handle. By the time I converted an involute gear profile or a rack to a triangle mesh then extruded and did a few boolean ops on it even the improved power of Aol 2.8 was barely up to the job.

While I could typically make herringbone gears happen the racks were a real trial. This had a bit to do with the fact that a rack profile does some really strange things when you apply Aol's triangle mesh routine to it.



You could extrude that and only get webbing on the outside surfaces. As you can see, however, you get lots and lots of triangles from Aol. I soon found that I could not make herringbone racks with more than about 12 teeth. It was easy to see with a rack that you ought to be able to describe it with relatively few triangles, so I gritted my teeth and decided to go directly to a solid description.

Using the Platonic Solids script as a point of departure, I began to develop a herringbone rack script.

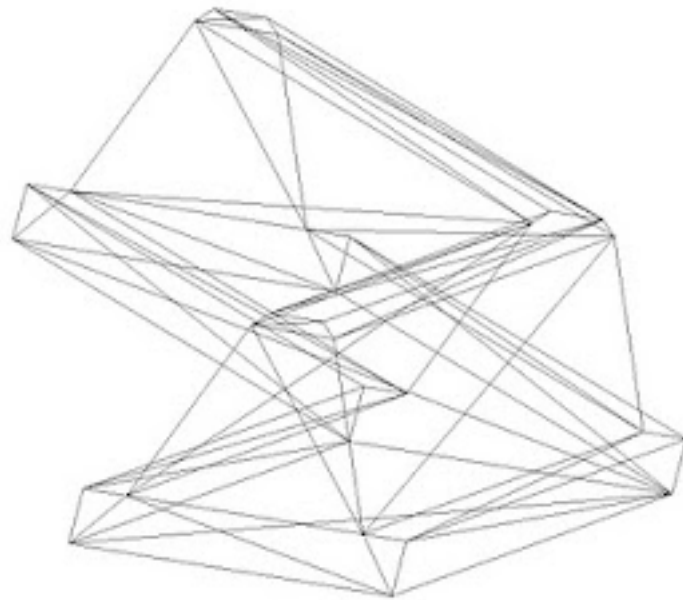

I finally got the whole thing going during lunch today.



I checked the resulting STL in Netfabb and determined that it was perfect.

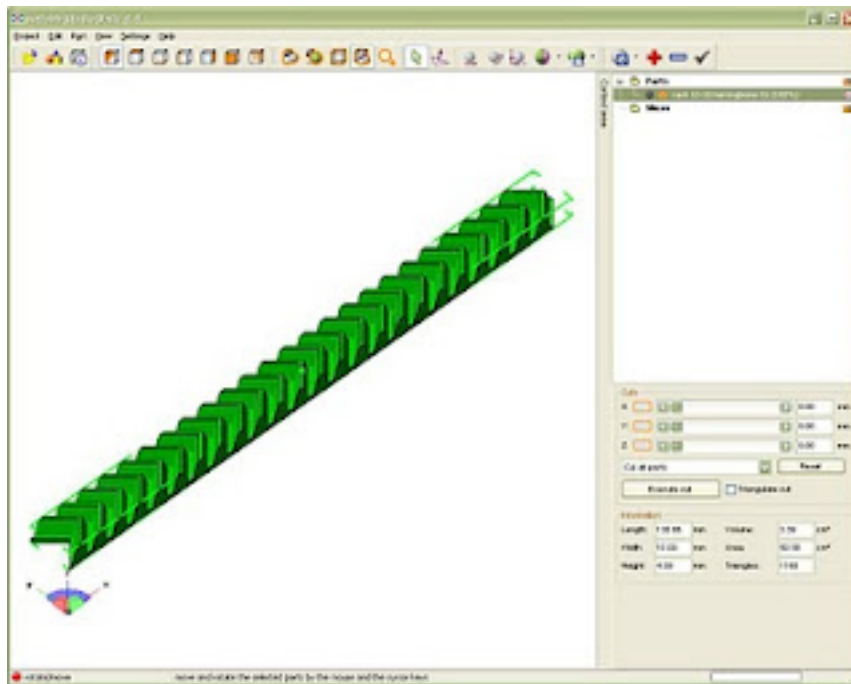

I developed a 12 toothed 10 mm radius herringbone rack and pinion pair.

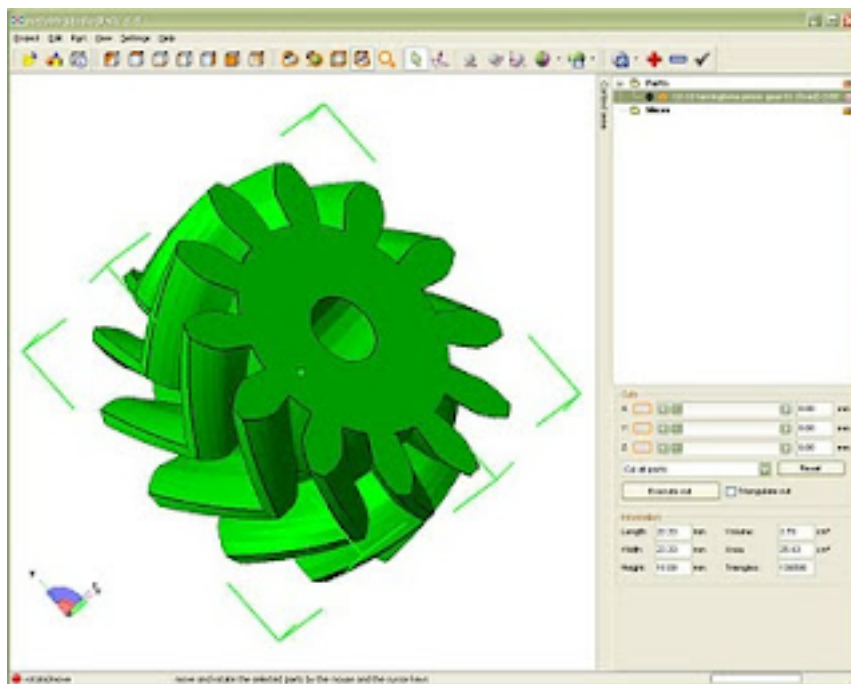

This configuration gives you about 0.3 mm/step when you attach a 1.8 degree stepper to it. Gear that down by a factor of 3 using another herringbone gear pair and you've got the 0.1 mm/step standard Reprap resolution.

Herringbone gears are pretty much naturally anti-backlash. They seat firmly, are quiet and have strong lateral resistance. They're printable and there is no reason whatsoever why you shouldn't be able to use them instead of a belt. I printed up a 130 mm rack and pinion set this evening.

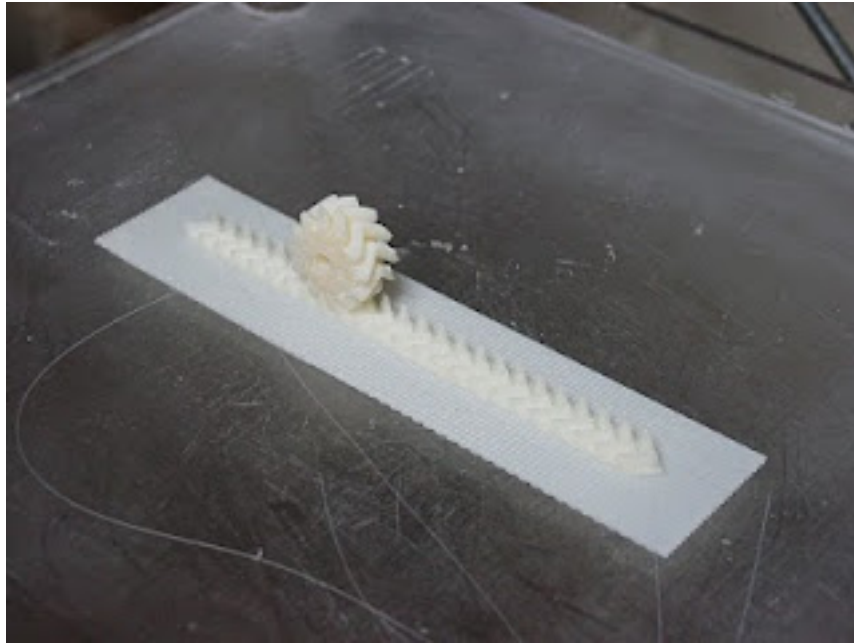

The racks can also, since they are very thin, be printed in long lengths without warping. Using a 0.3 mm extruder orifice and printing at about 16 mm/sec I completed the rack in about an hour and twenty minutes and the gear in 45 minutes.

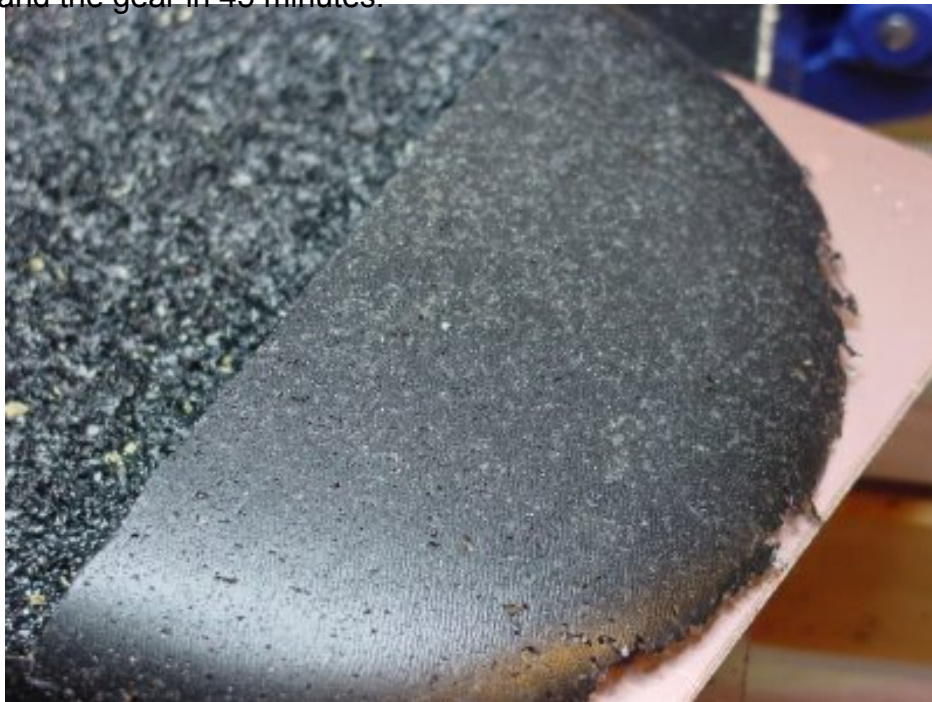

I've been able to make rack and pinion sets with gear finenesses of 24 teeth for a 10 mm radius. That's really pushing the envelope, though. It appears that 20 teeth for 10 mm radius is a

practical limit.

I intend to clean up the rack script and write one for the herringbone gears now that I know that they work well. I will make the scripts available as soon as I have them cleaned up a bit.

This experience has brought home what I consider a very important point for me. We need to be looking for technologies that aren't necessarily cheap or usual in metals. Such components are dependent on purpose built milling machines. Our printers are much more flexible than that. We need to choose technologies to print with that in mind.

Friday update:

I queued up a 267 mm rack while I was working this morning. No warping.

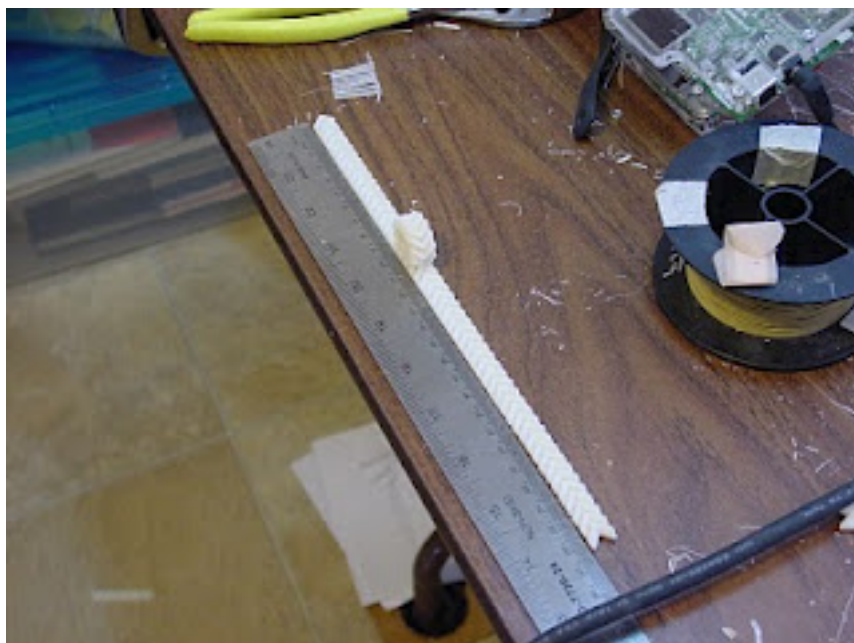
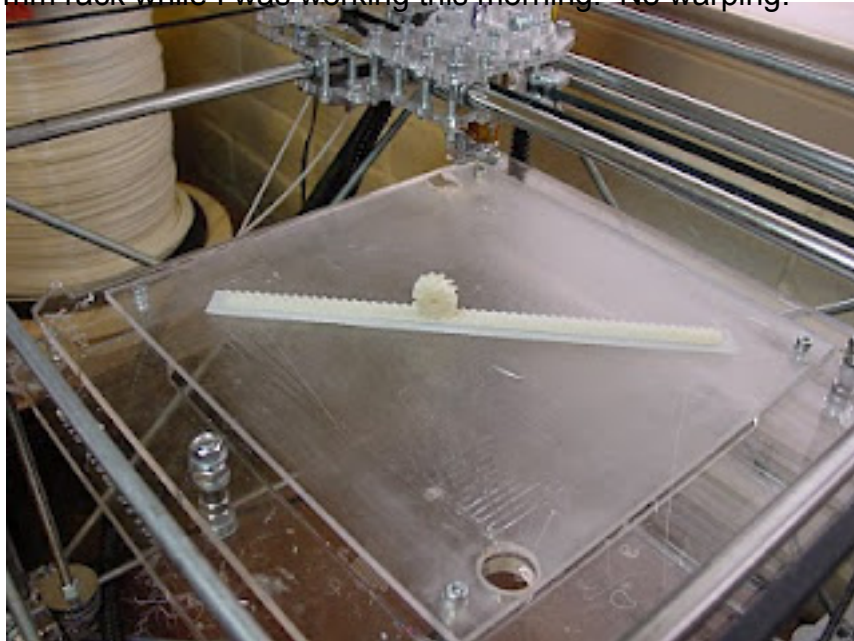

Not bad.

New Software - May Contain Nuts...

Sunday, 24th January 2010 by Adrian Bowyer

...but fewer.

I've been a bit quiet for a while, owing to the fact that my pathetic brain can either communicate or work, but not both. About six weeks ago, I decided that the Java host software had not been looked at seriously for a long while, what with all the Mendel hardware developments that had been going on. So I decided to take it apart, put it back together again, then throw all the funny-shaped bits that were left over in the bin.

Ages ago Forrest started to develop his pixel-based STL slicing software, where the pixels are at the RepRap machine's resolution (about 0.1mm). I thought that this was **All Wrong**, because it was going to be inefficient in memory use, and would not scale well. But I did think that a very similar scheme that used a quad tree to represent slices might be a good idea.

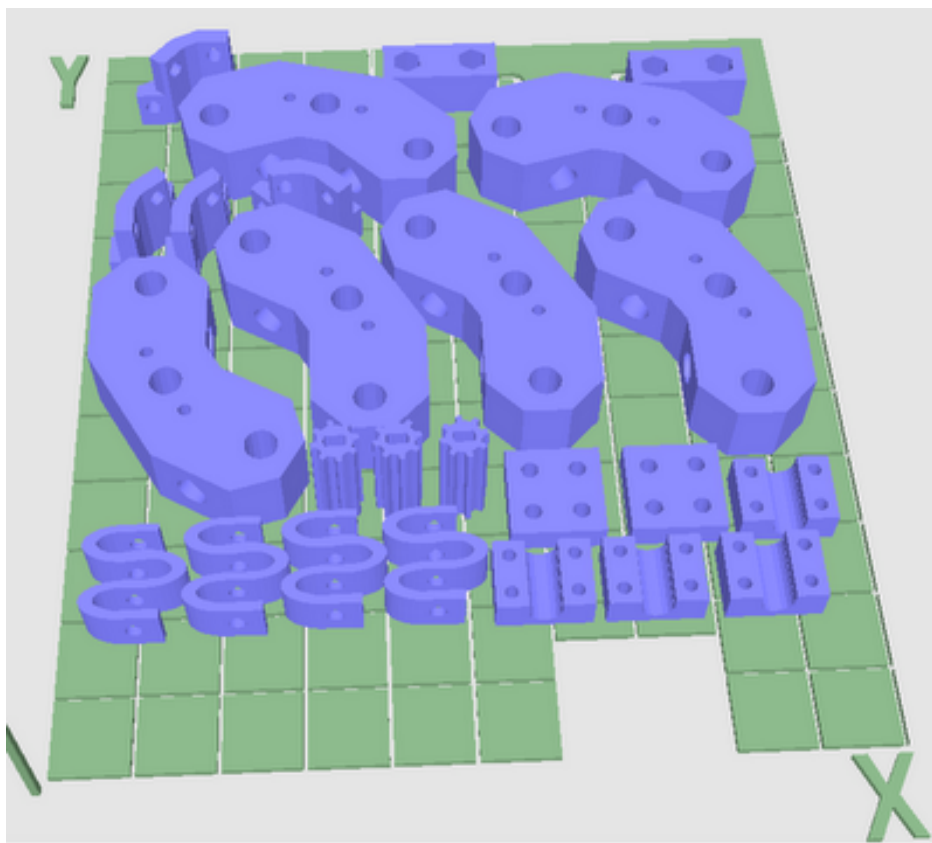

Just before Christmas, I realised that it is very easy to do unions and intersections on quad trees recursively (something I should have known...), so I implemented it.

But, though it worked reliably, and it was parsimonious in its memory usage, it was very slow in

execution. A bit of testing revealed that it was the continuous quad-tree-walking to access pixels that was eating the clock.

So I threw away the quad trees and replaced them with pixel maps in the form of Java BitSets. That went a lot faster, and - in fact - didn't use much more memory at all. So Forrest was not **All Wrong**- he was **All Right**.

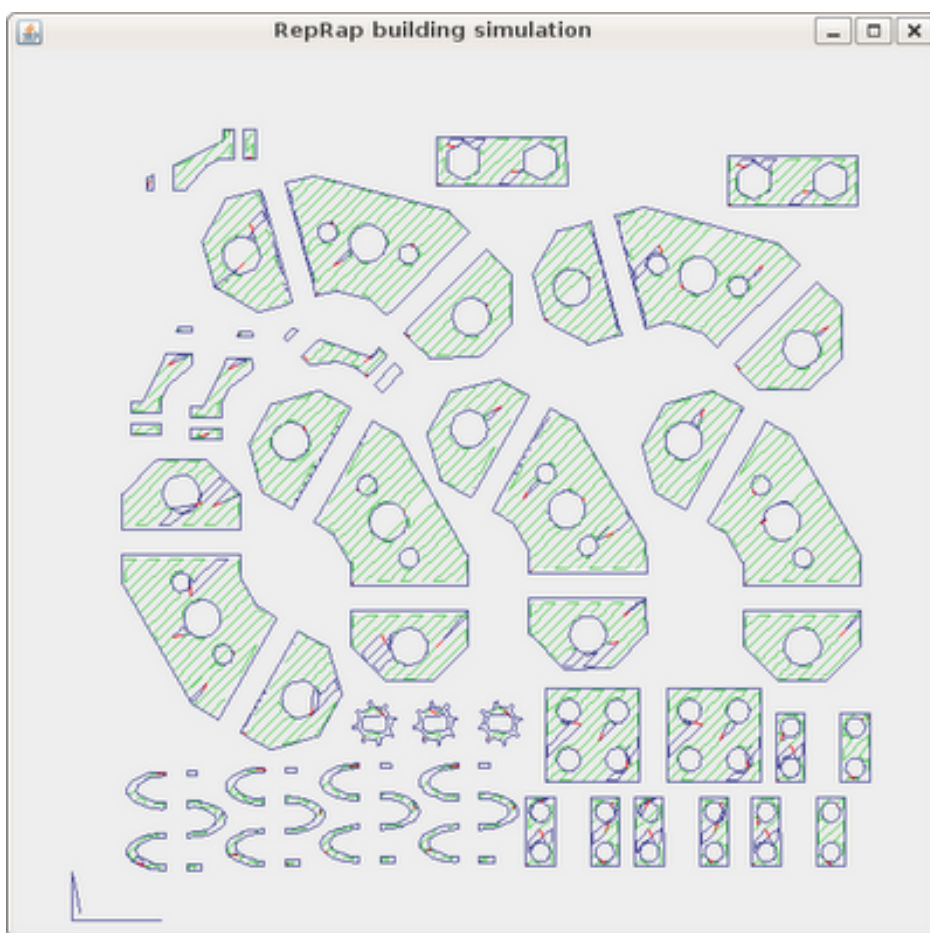

The code probably still contains bugs, and I want to do more testing before doing a release, but it seems to be able to reliably compute the G-Codes for an entire Mendel tray build (pictures above). On my 2GB AMD Sempron 3800+ running Ubuntu that takes about 2 hours. The total-memory monitor for the machine hovers around 630MB for all that time, not creeping up, implying no memory leaks.

It will handle multiple materials and allows single objects to be made from several STLs - one for each material. It does fine-fill over the surface and coarse-honeycomb interiors properly. It also now asks you how many of each thing you want to print, to save having to load multiple copies of them.

The next thing to do is to get RFO file reading and writing implemented, so that you can set up an

entire tray, save it, load it, and edit it. Then I'll do automatic support calculations (virtually all the code is in there to handle that anyway, now).

It's in the usual place in the repository - [download instructions here](#).

Getting there with herringbone rack and pinion

Tuesday, 26th January 2010 by Forrest Higgs

I finally hit a break in my day job and after sleeping the clock around beginning Friday afternoon was able to get back to my Reprap work. I'd been working with herringbone rack and pinion design and had begun writing Art of Illusion scripts to generate this kind of technology. I'd done most of the rack script a few weeks ago, but I needed to be able to design herringbone gears a bit more efficiently.

Finally, on Sunday the scripts for the racks and gears began to come together. After a considerable amount of feeling around I found that I could reliably print an 8 mm radius, 12 toothed gear. Connecting such a pinion directly to a 1.8 degree step NEMA 17 gives me a 0.25 mm/ step on the axis without microstepping. I then designed a 32 toothed gear which let me get that resolution down to 0.094 mm/step. You can see the layout here...

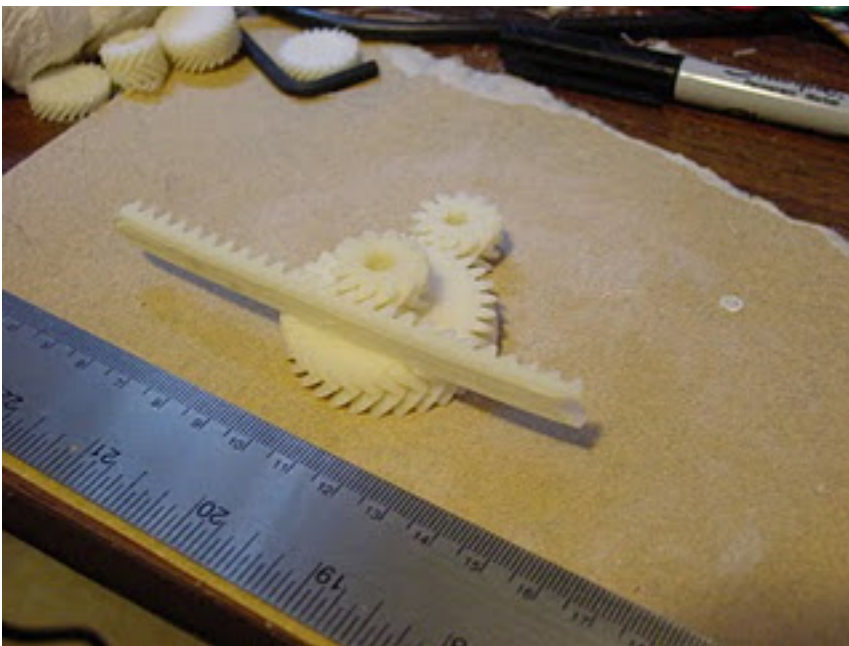

The NEMA 17 turns the 12 toothed pinion at the top of the picture. It turns the 32 toothed gear which shares an axle with a second 12 toothed pinion which engages the rack. It's simple, easy and quick to print and doesn't backlash if you apply just a slight bit of compression to the gear train. My next task is to design a printable axis assembly to seat that assembly. My goal is to get rid of the skateboard bearings, too.

The scripts are in a lot better shape, but they're still not really ready for prime time.

Build a better RepRap: \$80,000 Prize

Wednesday, 27th January 2010 by Adrian Bowyer

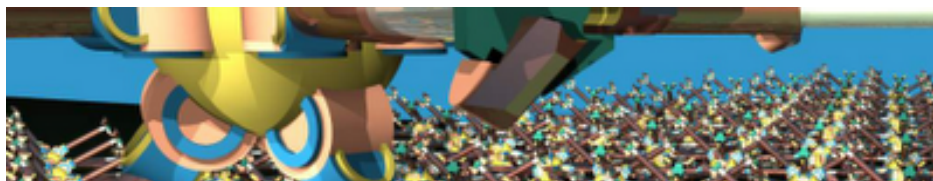

The Foresight Institute has announced its Kartik M. Gada Humanitarian Innovation Prize to design and build a better RepRap. There is an interim prize of \$20,000, and a grand prize of \$80,000. They consulted with the core RepRap team before the announcement and we were initially concerned that the prizes might drive developers to secrecy in order to give themselves a competitive edge. As you will see they have addressed those concerns by making it a condition of winning the prize that solutions should be pre-published and made available under a free licence. For ourselves and on your behalf, we would like to thank the Institute for the enthusiasm that these prizes demonstrate for the RepRap project and for their magnificent generosity.

Reprappers: to your designs! To your experiments!

Upcoming server outage

Wednesday, 27th January 2010 by Sebastien Bailard

We are pleased to announce that RepRap.org will have a brief server outage at 8:00 PM on Wed, 27 Jan 2010 Pacific Standard Time. This will last no more than an hour, and ideally will only take 15 minutes.

This will be at 04:00 Thu, 28 Jan 2010 UTC.

(We're moving servers.)

Regards,
Sebastien Bailard
RepRap.org

Paste Extruder - The first test

Friday, 29th January 2010 by Rhys Jones

Paste extruders seem to be all the rage these days. They would allow RepRap to utilise a load of new materials to increase the replication count, and also enable us to use a soluble support material. Zach came up with the Frostruder MK2 , and it seems to be the best way of tackling the problem. Zach's idea was to use high air pressure directly to force the paste out of a syringe rather than to use a piston driven by a motor. The real beauty of Zach's design is a relief valve that is able to exhaust the high pressure air from the syringe. This prevents any paste oozing from the nozzle when extrusion needs to stop, a difficulty thats plagues a lot of motor driven systems.

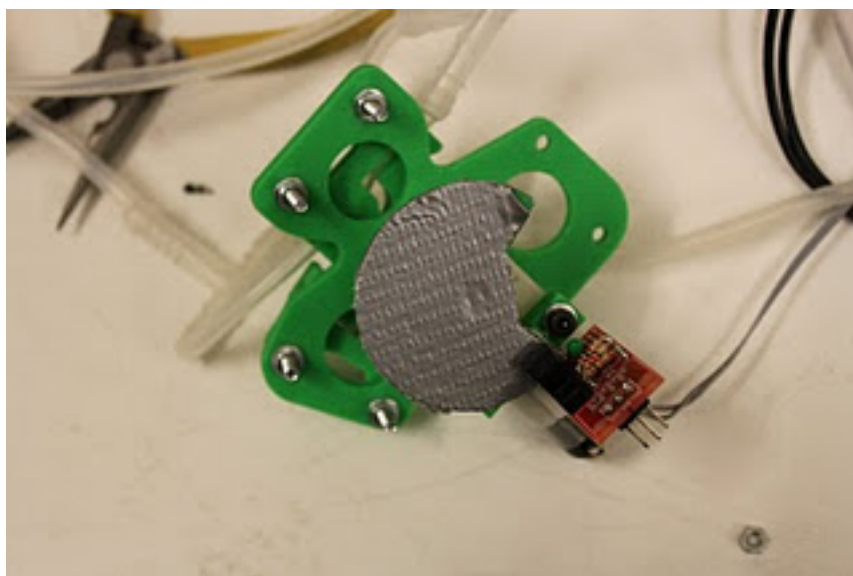
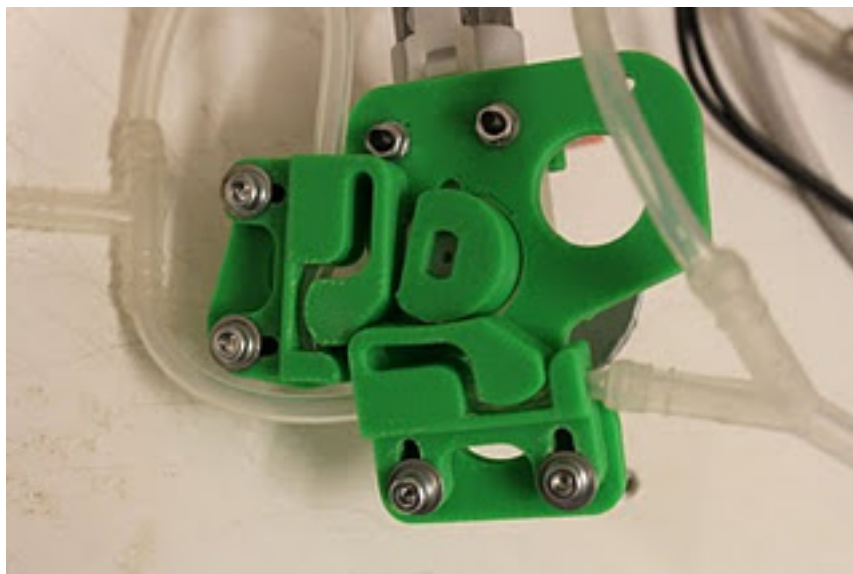

The main difference between this design and others is in the valve. Patrick came up with an idea

for a pressure valve based around some rebrapped springs and a cam, to clamp a piece of silicon tubing and cut the air pressure. We control the position of this cam by using a simple rebrapped tacho, an optoswitch, with the entire mechanism connected to a DC motor.

Secondly, the frostruder design has the high pressure acting directly on the paste. I initially replicated this, but found that for relatively "thin" pastes, the high pressure air was able to bury directly through the paste and come directly out of the nozzle. I employed the use of an intermediate bung between the paste and the pressure. However, the ooze from the nozzle is substantial due to the increased friction unless the bung and the syringe were coated in silicone grease. Adding the grease results in virtually zero ooze.

In addition to the valve, we hacked together a compressor based on a 2L drinks bottle, and a car tyre inflator. What is particularly nice about this is that the tyre inflator is 12V DC i.e. we can control it directly from the MOSFETS on the Extruder controller. As yet we haven't hooked a pressure sensor into the system, but its something we intend to work on(or rather its something we want to replicate)

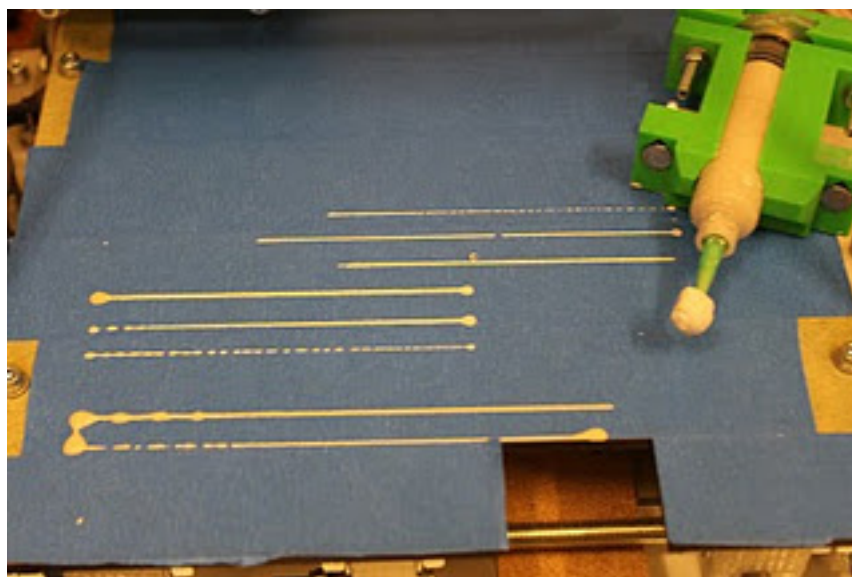

The above was my first test with the extruder on the machine, attempting to find an appropriate axis speed for a given pressure. The extruder started and stopped with pretty much no lag or ooze. I was manually starting and stopping the extruder by hand with a second optoswitch (We haven't got the firmware sorted yet), which is the reason for any large blobs at the start or finish. I was using the soluble support paste I described in a previous post, I guess each line shown in the picture above dried in under a minute.

All in all, the entire setup cost about £20, I'll be posting some more results next week after we get the entire thing to be controlled by the host software, which should also bring better quality results.

Mendelssohn & LCA2010

Saturday, 30th January 2010 by Vik Olliver

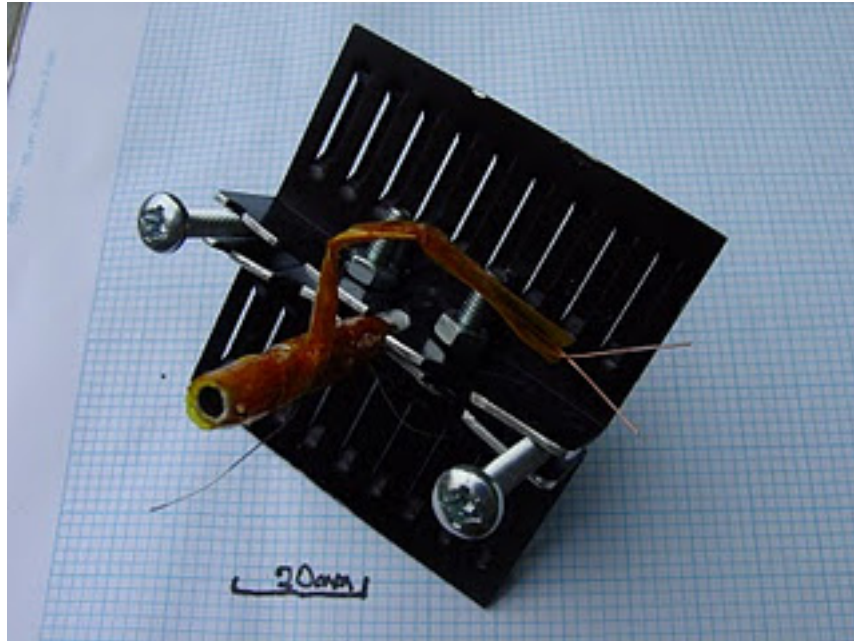

Finally got over the flu that I brought back from LinuxConf 2010. Mendelssohn is now printing properly with a stepper-driven extruder and a new heating element/barrel design. This is essentially the old hack using a radio aerial and a heatsink. The M4 nozzle (not shown) fits **inside** the feed tube, so increased pressure forces the nozzle into a shoulder at the end of the tube. So the more pressure, the better the nozzle seal. The shoulder is created by slowly cutting the tube with a pipe cutter.



I'm dip-coating the 3/16" brass tube in fire cement slurry, drying this, and then wrapping the dry ceramic in Kapton to protect it while I wind on about 6 ohms of nichrome. If the Kapton gets vapourised, the heater element will not then short out on the brass tube. The heatsink traps the extruder as well as cooling the end of it, and also acts as an anchor point for connecting the extruder assembly to the X carriage.

Works so far. No lathe needed, no PTFE, no creep, no leaks.

Vik :v)

Many useful little things...

Sunday, 31st January 2010 by Forrest Higgs

Back in the late 1960s when I was very young and worked for IBM for a few years there was a magnetic tape that always lay beside the operator's console on the ancient IBM 360-40 computers labeled MULT. One day I worked up the temerity to ask the operator what it was and he said MULT stood for "many useful little things", viz, MULT. It was a compendium of utilities programmes that enabled the operator to maintain the old 360 and, given how reliable mainframe computers were in those days, was always kept very close at hand.

The projects that I've begun to undertake vis a vis Reprap reminded me of that old mag tape. Basically, I've been undertaking to explore technologies that might get the Reprap community into the next generation of Reprap machines. More to the point, I'm trying to crack some of the technical challenges posed by the Kartik M. Gada Personal Manufacturing Prize. Mind, I'm not looking to compete for the prize. The technical challenges, however, are very interesting.

Before the Gada Prize was announced, I was developing herringbone racks and pinions as a printable alternative to belts. Once the prize was announced, the 90% printed by volume and the 60 watt power limit specifications drew my interest. Prior to the prize announcement, I'd bought all the pieces to build up a heated bed for my Rapman 3.0 printer. It was obvious, however, that there was no way that a 3D printer with a heated bed was going to be possible using less than 60 watts.

At the time that I was thinking about all of this I was trying to develop a rail system to contain my herringbone rack so that I could use it to drive axes. I wanted to build a Delta Robot something along the lines that Festo had done.

The Festo Delta Robot uses lead screws in the three columns that seat the arms that move the extruder. I wanted to replace those with herringbone racks. I also wanted to make the columns printable. In that a usable Delta 'bot is about a meter high, it was obvious that I wasn't going to be able to print a column in one piece. That put me face to face with the question of how to make a large piece out of a bunch of little pieces.

The conventional approach is to simply bolt the small pieces together. Frank Davies took this approach with his brilliant Sarrus Linkage positioning system.

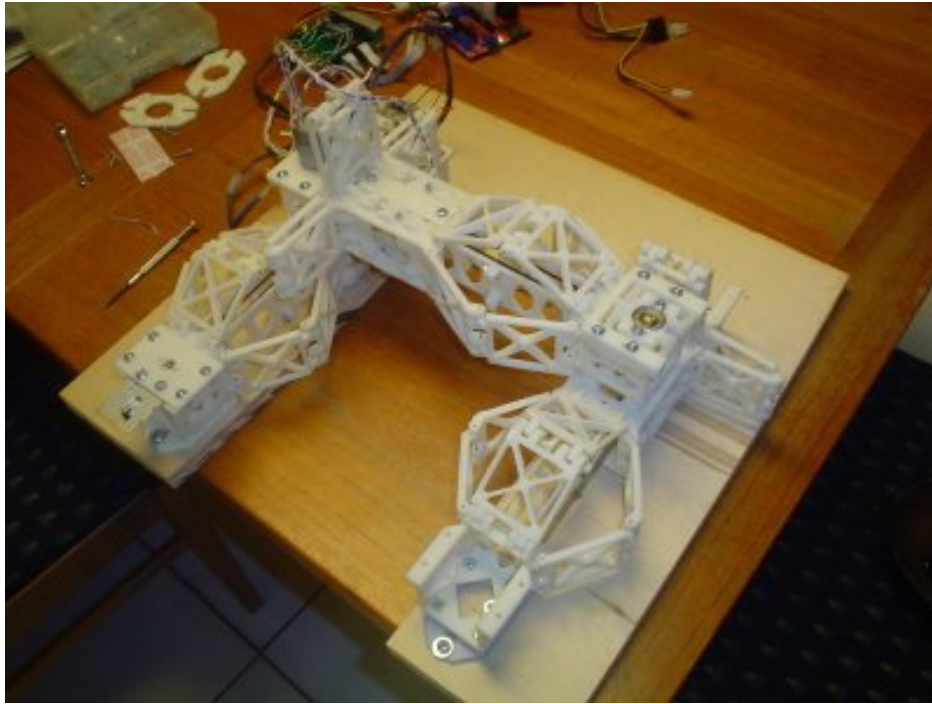

Frank had avoided a lot of problems with printing larger parts by using relatively thin-walled, open structures. I shamelessly stole a lot of his techniques after having printed part of his Sarrus system. While thinking about that it occurred to me that you get relatively little warping if your part's biggest xy dimension is less than about 50 mm. Most of the parts I wanted to print had a cross section much smaller than that but were long and I needed them to be VERY accurate. Then came the little epiphany. Why not rotate the long dimension to the vertical and leave the small cross-section on the xy print surface? Nophead {Chris Palmer} quite rightly pointed out that for a beam the extreme fibres on the upper and lower surfaces would be no stronger than the bond between two layers of printed plastic whereas if you printed the long dimension flat on the xy plane the bond between layers would only be subject to shear stress. In spite of that I began designing a columnar rail system for my herringbone racks and began printing it vertically, reasoning that a bending stresses would not be as severe in a column as in a beam. After half a dozen false starts I finally got a design I liked. I rewrote the rack generation script for Art of Illusion so that it would put a flange on either side of the rack and then designed a cross-section that would seat racks on front and back sides. One of the racks would carry the drive pinion while the other would seat a pair of unpowered bogies to stabilise the positioning assembly. Here you can see a printing of a 100 mm long pair of these columnar rails.

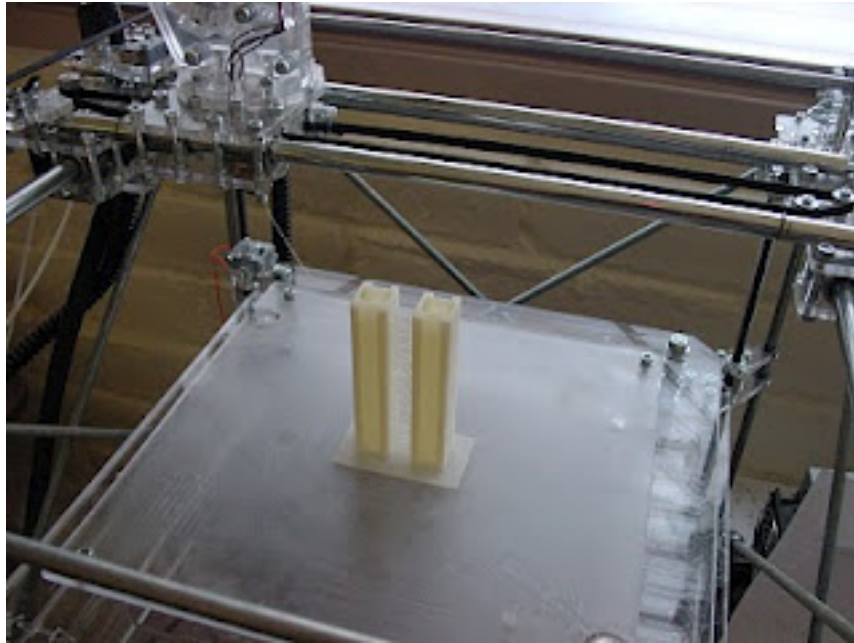

Note that printing vertically allows you to create hollow structures, something much more difficult to do with present technology if you print them on their side. Also note how much like an extruded plastic or aluminum section this columnar segment looks. That was intentional. If some enterprising small Chinese factory starts paying close attention, it may be that this sort of section can become a very cheap vitamin instead of something that Reprappers in well served market areas have to print. That cuts down replication time dramatically.

I'd originally designed the column elements to test whether the rack prints fit properly. They did.

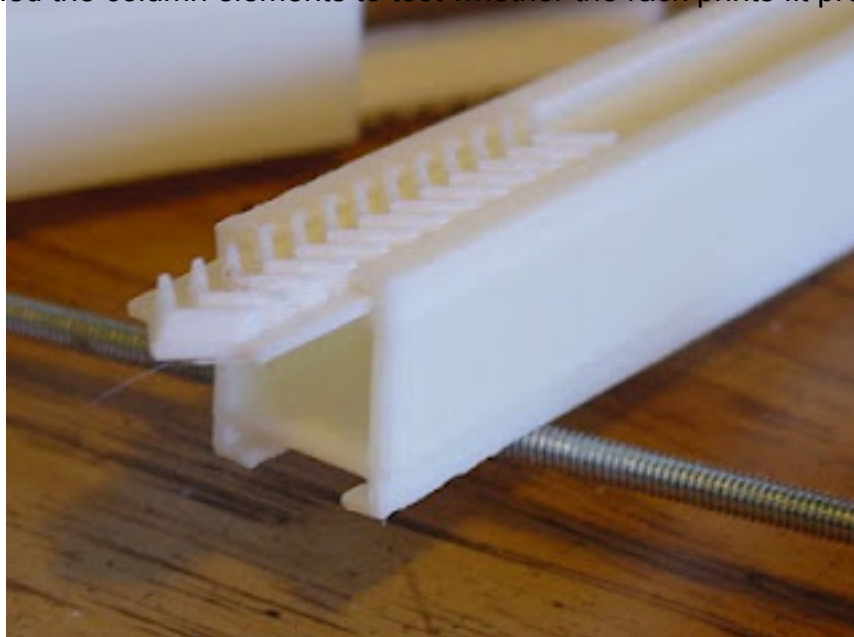

Before you start thinking that I'm some sort of design wizard, let me say that it took me four tries to get the fit right. This sort of design thing is very hard work for me.

That accomplished I was beginning to design the connection between the columnar segments when it occurred to me that the rack prints already did that.

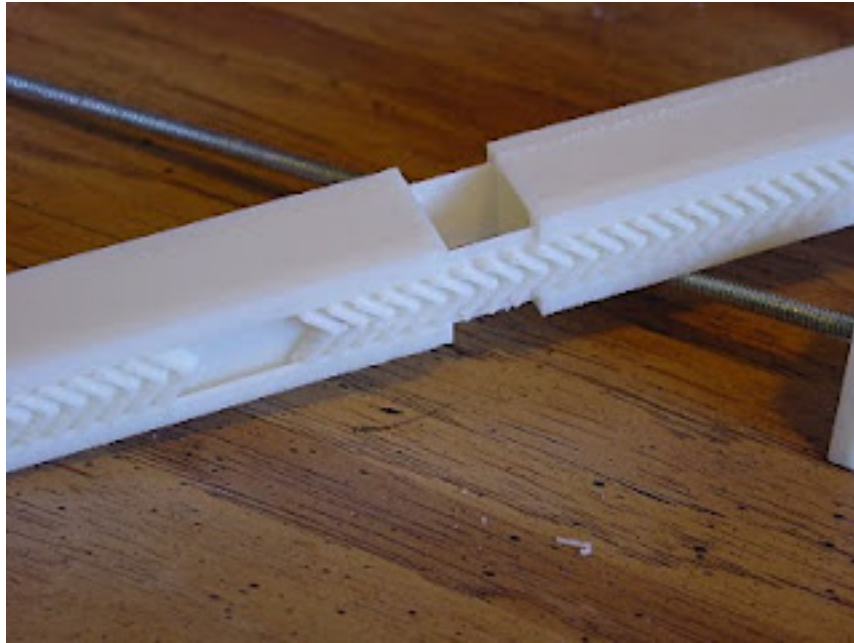

What is nice about this approach is that you can simply slide rack segments into the column until it is full. I found as a practical matter that the segments dovetailed very accurately with just a touch of very fine grit sandpaper to knock off tiny bits plastic flash on the ends.

Just looking at the system one immediately realises that the joint between segments is not what you would call a particularly strong. That is where an old trick I learned in architectural and structural engineering design eons ago came into play, viz, post-tensioning. In construction concrete is well known for being able to resist huge compressive loads but can resist virtually no tensile loading at all. Plastic, the way I was printing it vertically, as Nophead rightly pointed out, doesn't have good tensile strength and will, given sufficient load, fail in bending. In that way it is very much like concrete.

In building in concrete post-tensioning allows you to overcome this problem. The method is quite simple. You cast your concrete structure leaving channels through it. After it has hardened {cured} you thread tendons through these channels and then use hydraulic jacks to put the tendons in tension. The tendons are connected to either end of the beam you are building by face plates. The tensioned tendons, usually made of either high strength steel rod or cable, compress the concrete beam strongly via the end plates to which they are attached. Any bending forces put on the beam thereafter have to overcome this compressive force on the concrete before the beam can fail. The method is very widely used.

I printed up some end plates and cut a piece of #8 studding {4.2 mm threaded rod} for the tendon.

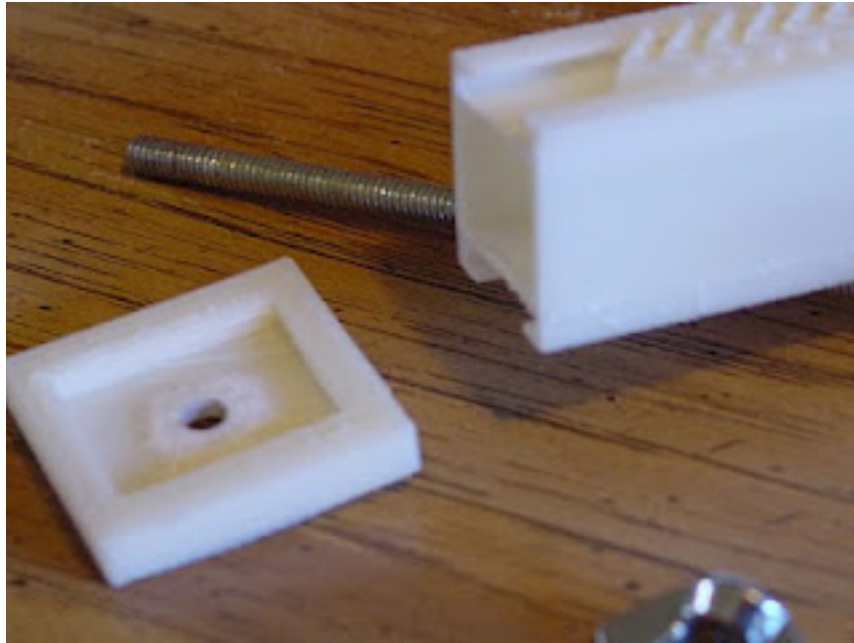

Here you can see the end plate and tendon in place.

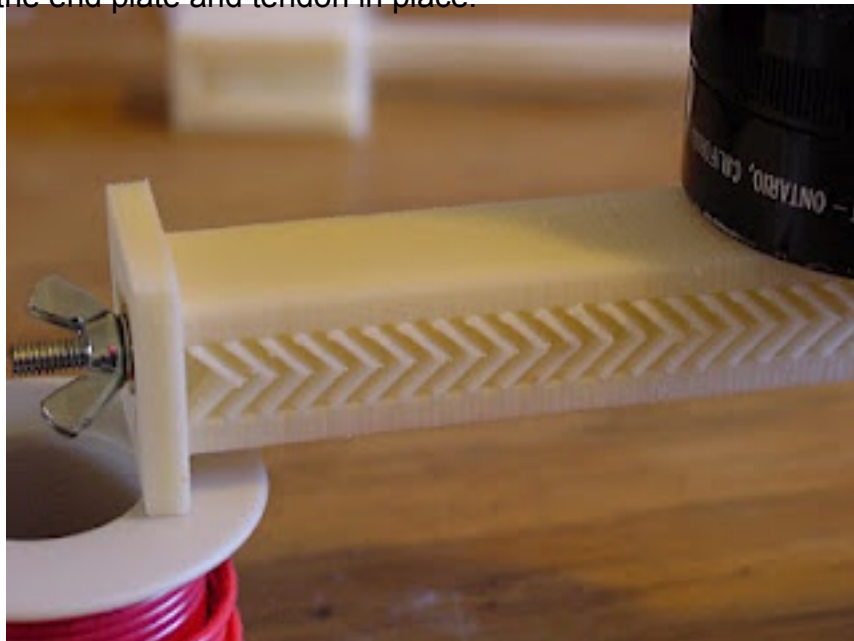

Finally, I point loaded the resulting post-tensioned structure with a 750 gram Mag-Lite. The 200 mm column section weighs about 45 grams of which the steel and fixings account for 12-15 grams.



No visible deflection was observed. This beam in this orientation is 18 mm deep, mind, and the top and bottom membranes are 1.75 mm thick ABS. I will use this same approach for both columns and beams in the Delta Robot I am designing.

I think that by deepening the beam to 24-30 mm you could probably replace Rapman's 12 mm milled steel guide rods {and probably Darwin/Mendel's ... I haven't checked the exact specification} with a post-tensioned, virtually entirely printed equivalent using about 6% of the steel {#8} as is presently used.

Keep in mind that the #8 studding tendon is massively overdesigned. I bought #8 simply because, for some odd reason, it cost about on-third as much as #4 {2.8 mm equivalent}. Using perfectly adequate #4 studding would bring that steel fraction down to 4%. Heavens, even #2 would do the job!

One issue with this kind of development is creep, the tendency of plastic under stress to deform over long time frames. It may be that we are simply not loading plastic to anywhere near the stress levels where this becomes a problem. It warrants a hard look, however. Unfortunately, the reference manuals on plastics creep are quite expensive, viz, hundreds of dollars and are rather spotty in the coverage of plastic types that they discuss.

Brass Tube Extruder Update

Monday, 1st February 2010 by Vik Olliver

Managed to blow the 4.7 Ohm filament at around 200C. By this time the wires were red hot, and a weak spot blew under the Kapton dammit. No matter, I have a New and Improved 6 Ohm version, all-ceramic insulation with double-twisted nichrome on the inputs to ensure a lower temperature on the input lines. I think it is those local hotspots that cause the Kapton to decompose. But hopefully I've just eliminated the Kapton - for the barrel insulation anyway; I might still use it to attach the thermocouple to the barrel for the moment.

Vik :v)

Multiple object saving and loading

Tuesday, 2nd February 2010 by Adrian Bowyer

I have done an implementation of .rfo files (see <http://reprap.org/bin/view/Main/MultipleMaterialsFiles>) in the Java host code. These allow you to load up a set of STLs, then save the whole lot as an .rfo file for re-loading later.

It's a bit experimental, and I need to fix it so that you can load-rfo, edit, then re-save. But if you want to play it's in the repository at

<https://reprap.svn.sourceforge.net/svnroot/reprap/trunk/reprap/host>

Mini Me

Wednesday, 3rd February 2010 by Adrian Bowyer

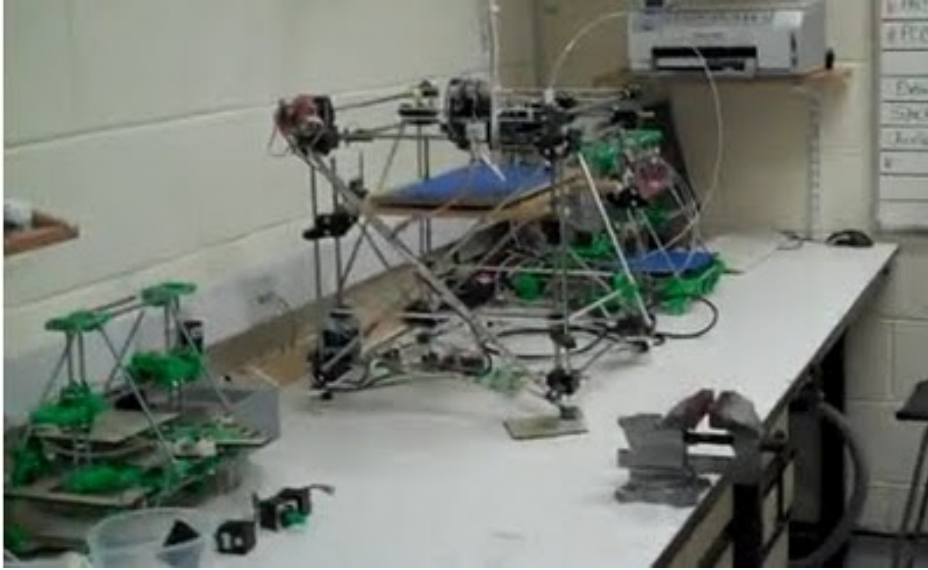

Just before he left to Starve in the New Zealand Wilderness Ed did a new RepRap design because he "had to get it out of his head". It was a mini version of Mendel. You can see it on the left in the picture above - a still from

Josef Davies-Coates' short documentary on the Bath RepRap Lab. The machine uses M6 threaded rods and M3 nuts and bolts (as opposed to the M8/M4 used on Mendel) and NEMA 14 steppers. The reprinted parts are about 30% of the volume of those for Mendel, which is to say it could reproduce three times faster.

This is a completely unsupported design for the moment (we haven't got the time...) but we have put the STEP file for it in the RepRap repository at

<https://reppap.svn.sourceforge.net/svnroot/reppap/trunk/mendel/mechanics/mini-mendel>

because it's so neat, and some of you might like to play with it...

Here's a close up rendered by M.BrittCrane :

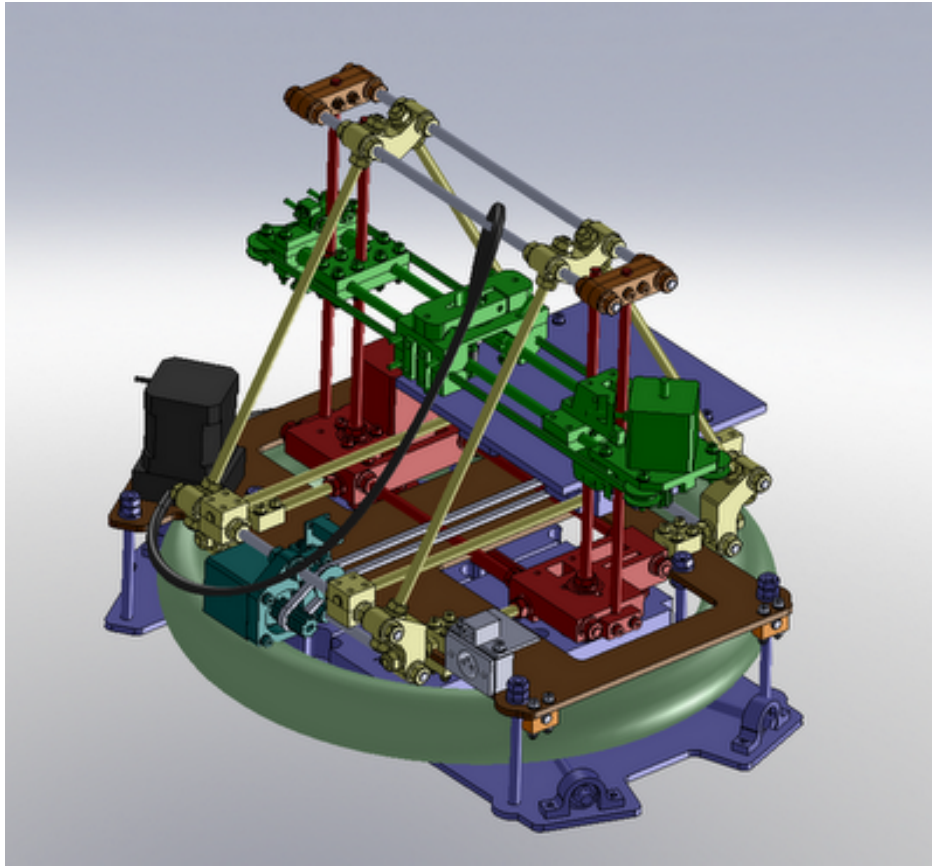

Thanks!

On reflection, I think that putting the material spool underneath is not a good idea: it tends to jam. Better to have it on a separate reel above (which would make the machine even smaller).

Testing the envelope

Saturday, 6th February 2010 by Forrest Higgs

This has been a pretty frustrating week. Last week I got a long way towards evolving a thin-walled approach to making post-tensioned, composite structures which could support herringbone rack and pinion systems. This week I wanted to push the post-tensioned theme a bit further and decided to see what issues were involved in printing an open structure beam/column system. For a first pass, I developed this stackable, interlocking beam module.

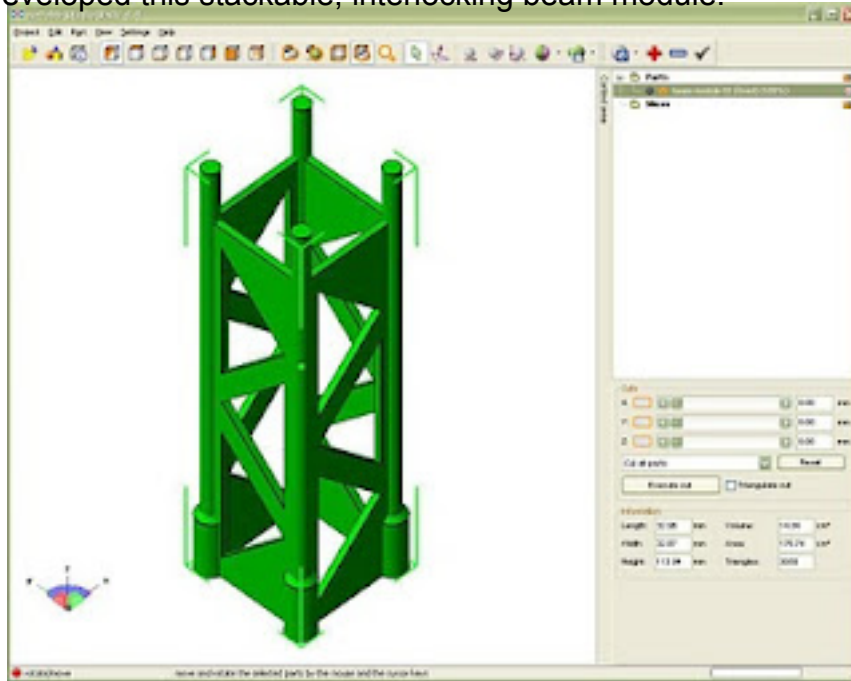

It was a bear to create with Art of Illusion, but with Netfabb to clean up AoI's nasty STL files I managed, finally, to make it happen.

I did some preliminary partial prints to see what the issues were and discovered that I could either print one segment using the Sleinforge cooling option and wind up many hours later with a column segment that was festooned with strings of ABS ooze OR I could print several in the same time which required much less after-the-print cleanup.

That is when the trouble started. In the several days prior to this exercise I'd discovered that I could print the column section for the herringbone rack at 32 mm/sec without a serious degradation in print quality. This made printing these beam segments much less daunting a task.

When I began, however, I ran into a nasty concatenation of disasters that pretty much ruined my printing week. The first one occurred when I started a print and shortly after was called away for about 45 minutes to help my sister install a new wireless printer she'd bought.

When I returned to the lab I discovered that my Rapman 3 had partially reset whilst printing the raft for the segment leaving the extruder running. This unfortunate situation burned a small pit in my print table and buried my Kapton tape extruder head in a big blob of molten ABS. The Kapton tape extruder head had been happily running since October, I believe, without complaint. Being buried in ABS, however, pretty much put an end to it.

Fortunately, I'd bought several of BitsFromBytes new pre-made, silicone covered extruder heads.

After about an hour swapping out the old, ruined head for the new one I was printing again ... almost. There was, of course, the usual running in of a new part. The new head was about 3 mm shorter than the old one, so I had to go through the whole adjusting for the new print height thingy,

complete with printing new trial rafts and the like.

That done, I went back to trying to generate a set of four of the beam segments with Skeinforge.

Months ago, I'd downloaded the latest release, August's. Skeinforge these days is a busy, overcomplicated piece of software which has far too many bells and whistles hung off of it. In concept and execution, however, it is a brilliant piece of work.

That said, my column segment exercise pushed right through Skeinforge's performance envelope.

It appears that when you create a BFB file with more than a million lines of gcode in it, that the August version of Skeinforge simply runs out of memory and blows up in the Export routine. After several false starts I finally got the most recent release of Skeinforge down and sort of working.

The memory problem was gone, but in its place was a total buffet of new bugs relating to both the Multiply option and the Speed option. The two options appear to interact to produce some really bizarre gcode.

I'd hoped by now to have the new Netfabb gcode generator. Sadly, the Netfabb people have discovered that the developing of that app was a bit bigger task than they'd originally thought, so the release date got pushed back from 1 February to 1 March. That left me with either going back to my old copy of Skeinforge and limiting myself to the sorts of objects that it could process or sitting on my thumb for four weeks and hoping that Netfabb's revised release date didn't slip again.

There had been a prior bit of frustration back in November that pushed me into reviving my old Slice and Dice software app from the Tommelise project, I had actually got pretty far along with that before I was able to get past Skeinforge's nasty learning curve and was able to print acceptably using it. I went back and looked at that. Recently, Adrian confirmed that I was on the right track using a brute-force, pixel-oriented analysis instead of the more conventional geometric approach. Of course, my code is hideously slower than Adrian's, an understandable situation considering that he has been doing this kind of thing for his whole career. :-)

Still, when I sat down and thought about my situation, I realised that it is in the nature of who I am that if I'm given something I will inevitably test it to its limits. I always try to make things do things they weren't intended to. That's just the Scots-Irishman in me, I suppose. Given that situation, it's very dangerous in a way, to be dependent on equipment and methods that one can't get into and tinker with. When Skeinforge crashed on me it was suggested that I turn in a problem report on how I crashed it and wait for Enrique to fix it.

Enrique is fast at responding, but I am still too obsessive, now that I am trying to work with post-tensioned, printed structures to happily wait to see if he can easily fix the problem. Indeed, I find myself not much wanting to even report the problem.

So ... back to working on Slice and Dice.

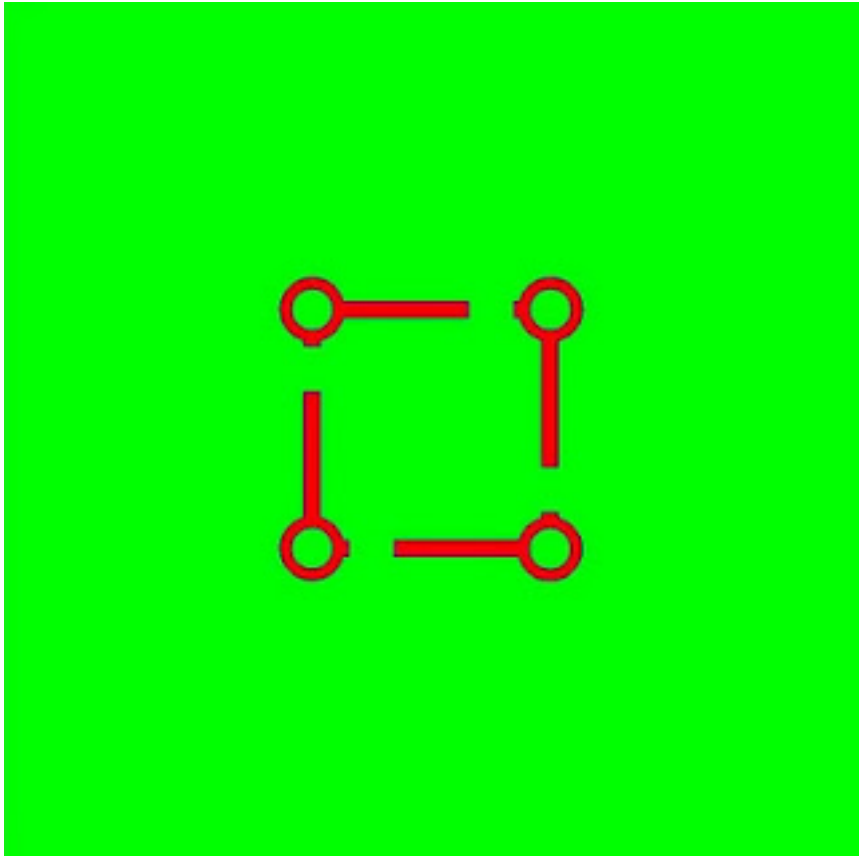

Full Colour RepRap?

Wednesday, 10th February 2010 by Adrian Bowyer

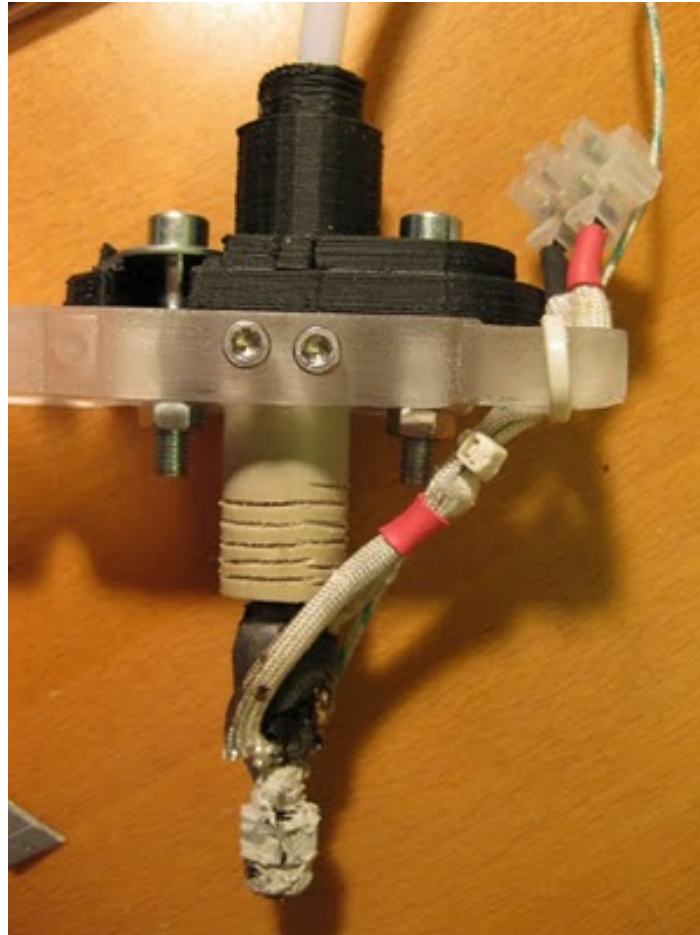

This is an idea that Erik, Batist and I had at FOSDEM.

Both Erik and Ed have now got Ed's Bowden extruder idea working, and Vik has now got a really simple, really slim extruder heater design.

So it ought to be possible to arrange three of Vik's brass tubes in a cluster at 120° to each other with a single heater and thermistor, and to splay out the top ends slightly to interface with three Bowden tubes. If the bottom ends came together in a small manifold block with a single nozzle, and you were to put red, yellow, and blue filament down the three tubes, it should be possible to get the three steppers to mix any proportions to give you any colour you want, I think.

The trick, of course, will be to have the fine nozzle as short as possible, and the mixing happening at the last moment in it.

The flow is very viscous, and so Reynold's number is very low. This means laminar rather than turbulent flow, and therefore maybe streaking rather than mixing. But if the head were to twist back

and forth, that might fix that problem.

RepRapping at the Maker Faire, Newcastle - March 13-14, 2010

Tuesday, 16th February 2010 by Sebastien Bailard

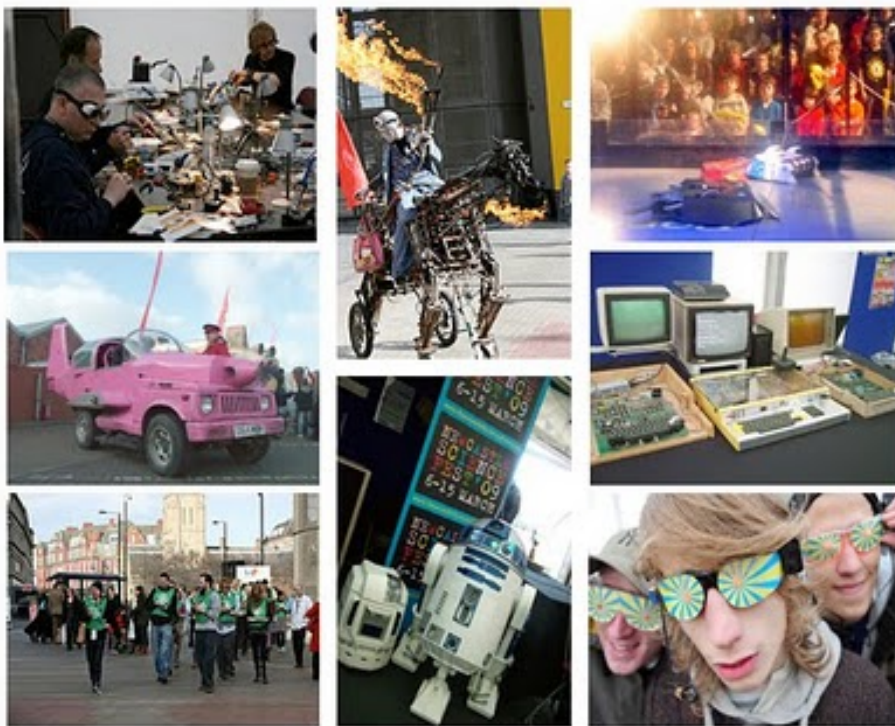

RepRap will be attending the 2010 Maker Fair in NEWCASTLE, UK

For more details:

[Forum Announcement](#)

[Maker Faire Announcement](#)

Also, I am pleased to remind you UK RepRappers out there that we have a [United Kingdom RepRap User Group](#).

For everyone else in the world, please check the list of all [RepRap User Groups](#). (These are good places to get or Mendel parts.) See also our [Forum for Selling Mendel Parts](#).

Lastly, if you're planning on building a RepRap, or want to help other people build them, and you don't have a RUG nearby, you are welcome and highly encouraged to [Start One](#) ! (Please note: [World_Domination](#) is not part of official or unofficial RepRap.org policy.)

Broadening RepRap Participation

Monday, 22nd February 2010 by Adrian Bowyer



Image not found.

As most of you know, RepRap's software and hardware files are currently hosted on Sourceforge using Subversion. This works fine from a technology perspective, but is not ideal from the point of view of those members of our wider community who want to contribute. In particular, it is difficult to branch the repository in a way that allows core developers only to have write-access to the 'official' stuff, but allows anyone to create branches that can subsequently easily be re-merged.

So, after considering lots of alternatives such as Git, we are *thinking* (and only thinking at the moment) of moving to Launchpad using Bazaar. This would allow anyone to create branches, to post patches, and so on in a way that could be merged with the official read-only trunk.

There are three equal parts of a RepRap: mechanics, electronics and software. It is particularly important that any system we choose should be as easy to use as possible for electronics and mechanics contributors. This is not to say we value software any the less - on the contrary. It's just that software people will cope well with whatever we choose. So bear that point in mind if you have views.

Speaking of views, before we do anything in this direction, we want yours. Do hit the comment link:

The Balls Return

Thursday, 25th February 2010 by Vik Olliver



Well, guess what? Supplies of suitable belt in New Zealand have completely failed to materialise. This comes as no great surprise to me, but must typify the situation in developing parts of the world. So, I am going to do a beaded belt (aka ball-chain or bath-chain) version of Mendel, using no fancy belts at all. The only problem is that the X & Y gears need to be very small to have enough resolution.

Well, the improved stepper drivers we're using have a slightly higher resolution than the old ones - not as high as the 16 micro-steps or more claimed by the chip specs, but useful. Also my printing skills have improved. This means that it may be possible to match a slightly larger chain with a slightly larger printed drive gear and better 0.1mm accuracy.

If that fails, it's time to break out the frickin' big "laser" ...

To the workshop!

Vik :v)

Drilling the extruder barrel

Saturday, 27th February 2010 by Vik Olliver



Having had a lot of fun with the Afghan Lathe - which is still fantastic for machining extruder nozzles out of dome nuts - I've found that using a drill press the wrong way round is a lot easier for central 3mm bores in the extruder. Apologies for the cross-post, but people seem to have found it very useful elsewhere:

<http://vik-olliver.blogspot.com/2010/02/drilling-down-middle.html>

I'll still be working on the brass tube extruder, but I'm going to get a few Mendels working first, with technology I know is reliable.

Vik :v)

Slice and Dice 0.1

Sunday, 28th February 2010 by Forrest Higgs

Last month, Adrian incorporated some ideas for using pixel maps that I'd used years ago with Tommelise 1.0 into what I understand is his most current version of the Reprap host software. At the time I was happy that my approach had proved to be of use to him. I was, however, happily using Skeinforge with my Rapman printer at that time and didn't think too much about it.

Enrique's Skeinforge is a brilliant piece of software for non-mainstream Reprap printers like my Rapman. As is my wont, however, I tend to test the envelope with just about any piece of hardware or software that I undertake to use. The problem with testing the envelope is that too often you push right through it. That happened to me when I started trying to print light, open structures like this.

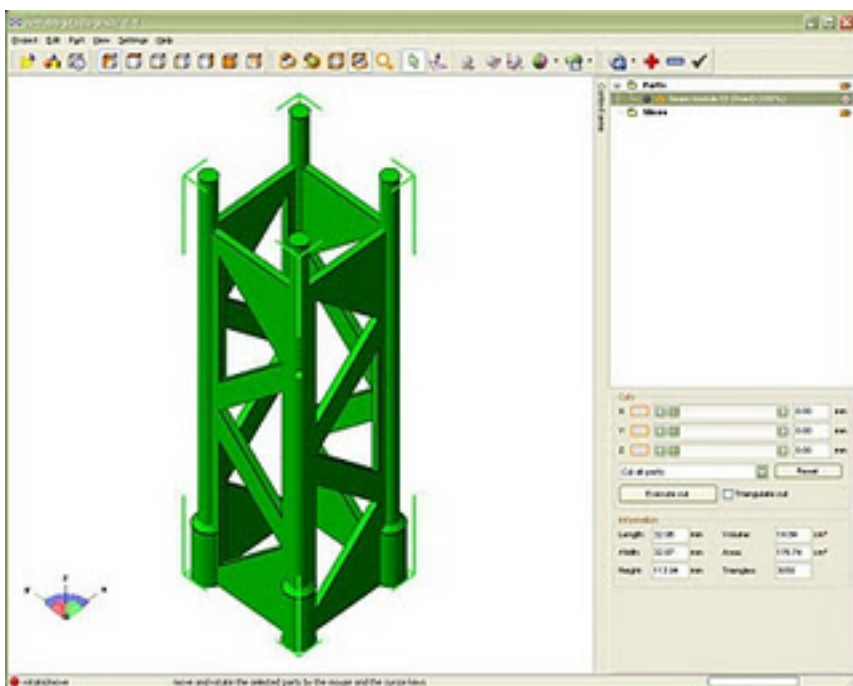

Enrique invariably handles error notifications within a day or two. I frankly don't know how he manages. It must require superhuman capabilities for one person to manage that for so many users. What I was trying to do, however, wasn't eliciting what could be termed an error as such. The individual slices for what I wanted to print were quite small. As a practical matter, what that means is that is that the layers tend to overheat from the extruder tip being over them too long on average. Let that go on long enough and you wind up with a print that looks like a melted candle.

Skeinforge has a "cooling option". What it does is time how long you are spending printing a layer and if it falls below your set point it orbits the extruder tip around the print till it has a chance to cool off. Thanks to the tendency of extruder tips to dribble ever so slightly, if you use this option your print becomes wrapped in what looks like plastic cotton candy. It is a bear to clean parts wrapped up like this. The other way that I developed when printing small pinion gears was simply to print 6-8 of the same thing at once, something that Skeinforge lets you do very easily. While that is very handy if you need a lot of a thing, if you're just trying to develop a part you take 6-8 times longer to print your part and find the errors in the design. With ABS costing \$10/lb using Skeinforge's multiply option is not a very practical as a cooling method.

I finally came to the conclusion that Skeinforge, as it presently is written, wasn't going to take me where I wanted to go. I had ordered a copy of the new Netfabb programme to do the same thing, then learned that their product rollout was going to be at least a month late {1 March}.

With several weeks of time on my hands, I decided to dust off my old Slice and Dice software and see if I could knock it into shape to do what I wanted. Three weeks later, it's running.

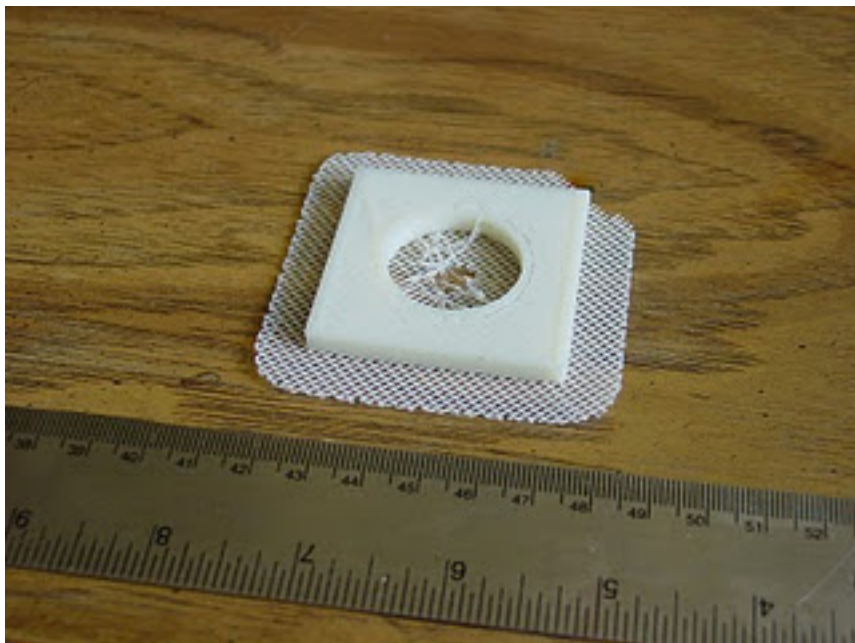

Let me tell you from the beginning that Slice and Dice 0.1 is most definitely NOT an alternative to Skeinforge, Netfabb or the Reprap Host software. If you are thinking that, forget it. Now I'm not trying to keep anything proprietary. If you want the source, I will give it to you under a BSD-type license which lets you do pretty much anything you want with it. Indeed, I've handed out several copies already to a few reprappers who wanted a look at this or that bit of the code.

Before you decide you want it anyway, however, here are some facts about it that you should be aware of.

- It is written in Visual Basic .NET {the free Express 2008 edition}
- It is Windows specific
- It is NOT beta code. I'd have a hard time calling it alpha code at this point.
- It is set up to handle only one print object at a time.
- It keeps multiple bitmap images {BMP} of each slice. These are 250x250 mm with a 0.1 mm resolution {figure 22.5 megabytes per image. All the processing is done on images that you can look at. What that means is that a decent design is going to generate many, many gigabytes of images. I don't care since I have a 1 Terabyte external disk committed to the programme.
- I will NOT provide support for Slice and Dice 0.1. If you take it you're on your own. I admire what Enrique is doing but do not envy his situation and most definitely do NOT mean to in any way compete with Skeinforge and Enrique or Reprap Host and Adrian or the good Germans who are fielding Netfabb. I'm not young and life's too, too short.

I've put Slice and Dice 0.1 together for one specific reason. That is to let me try out off-the-wall 3D printing ideas that often times will go beyond the capabilities of ordinary software. Most importantly, its a piece of software that I've written and can easily dive into myself and fiddle with to make it do new things without having to report problems to and make requests from others. I figure it will save me a lot of development time by shortening the development cycle. It for sure will keep me from making a pest of myself making requests for changes in their code to Adrian and Enrique. That should be good for everybody's nerves.

This posting is also posted at my own blog, [Diary of a Technocratic Anarchist](#). If you are interested in following the progression of blog entries leading up to this posting they can be found in the [February entries](#) to my blog. That's pretty much what I've been doing during the last month.

Erik de Bruijn's RepRap Survey

Monday, 1st March 2010 by Adrian Bowyer

Erik de Bruijn has put together a survey at:

<http://www.reprapsurvey.org/>

about your motives and efforts to use and to develop RepRap, or any derivative machine (for example, MakerBot). The survey is being done under the auspices of MIT and Tilburg University.

It doesn't take long to fill out, and it would be a big help - not just to Erik, but to all of us - if you could do so.

So I encourage you all please to take a few minutes to click the boxes.

New Release

Tuesday, 2nd March 2010 by Adrian Bowyer

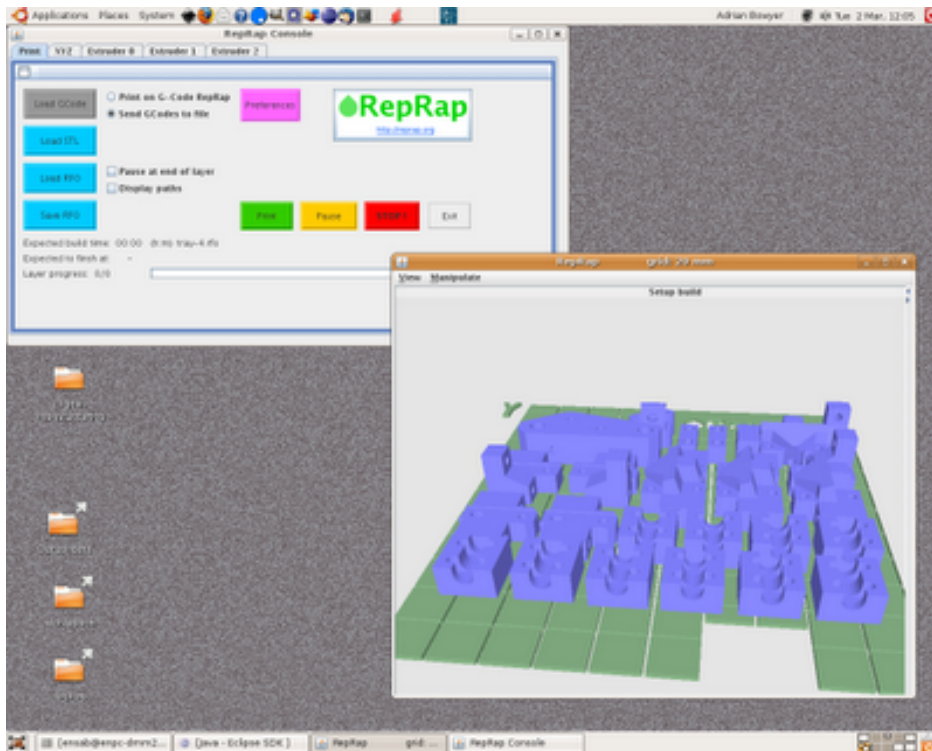

I've just put out a new release at:

<https://sourceforge.net/projects/reprap/>

Features include:

1. Full multi-material handling, including using different materials for outline, infill and overhang-support. This anticipates the Mendel multiple head/head changer that we're working on. It also allows you to use a single material in three different patterns for those three functions.
2. Full RFO File support. This allows you to load lots of items to be printed, move them about where you want, and then save the setup for future use. You can also load multiple copies of a single object with one click.
3. Pre-defined RFO files for a complete Mendel. These allow you to print a copy of a Mendel with minimum fuss.
4. Checksums in communication. The G Codes sent from the host computer to the RepRap machine down the USB now have a checksum added, and the firmware can request a resend in the case of an error.
5. Layer counting on builds. The software embeds layer numbers as comments in the G Code files

it generates, then uses these to report build progress.

The documentation [for the new host software is here.](#)

Coming soon: build to layer N; pause at the end of the current layer; start build at layer N, so you can stop a build in the middle, then resume it later.

Here is Mendel building the fourth RFO file (of six) that represents all the reprapped parts of itself. (It's not nearly as loud as it sounds; the video camera boosts sound levels when it can't hear talking...)

[RepRap Mendel making Mendels from Adrian Bowyer on Vimeo.](#)

Printing light structures

Tuesday, 2nd March 2010 by Forrest Higgs

A month ago, I designed a light frame structure which I could post tension and use to replace much of the steel in a next generation Reprap printer.

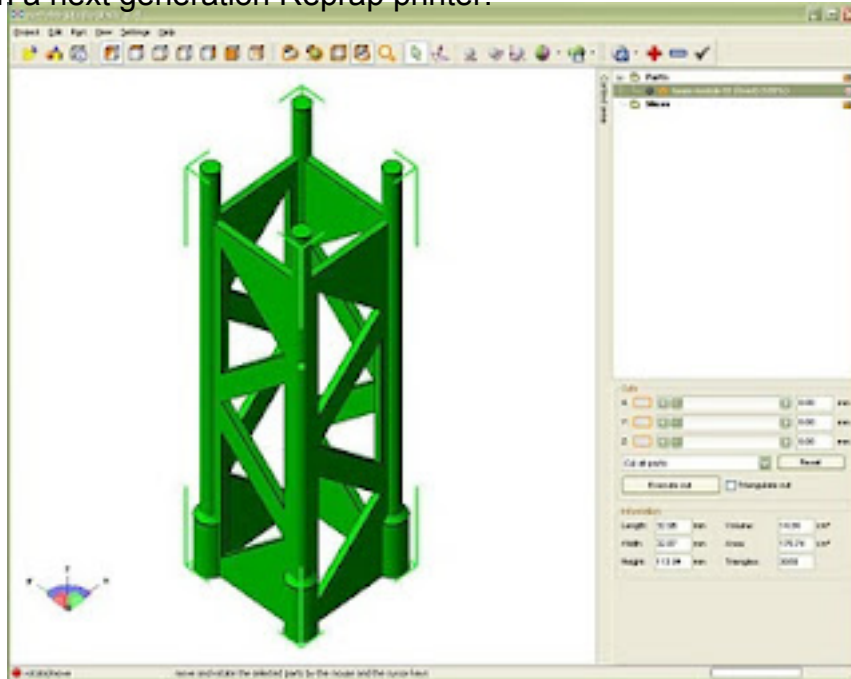

Processing it into gcode with Skeinforge proved to be impossible. That led me into a meandering sidetrack which had me pushing my old Slice and Dice code into working order after several years of neglect after Netfabb ran late with the release date for their STL to gcode processing module.

Last weekend, I got Slice and Dice working acceptably.

After work yesterday afternoon, I decided to see if I could make my Slice and Dice alpha code successfully generate gcode for a print of that same light structure. There were a few hiccoughs.

Fortunately, Slice and Dice is purposely designed to let me deal with difficult prints. I was able to identify problems by doing partial prints and tweak my settings to get past them.

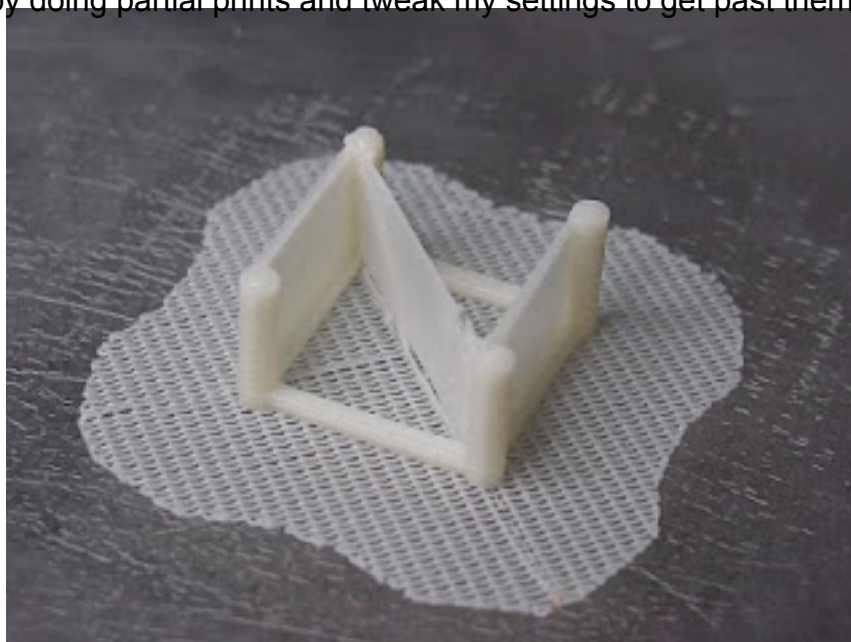

When I got up this morning I finished processing the light structure STL and set my Rapman

printer to work on it. Being a stand-alone 3D printer, it happily worked while I got on with my day job. Roughly 90-100 minutes later, I had a printed module.

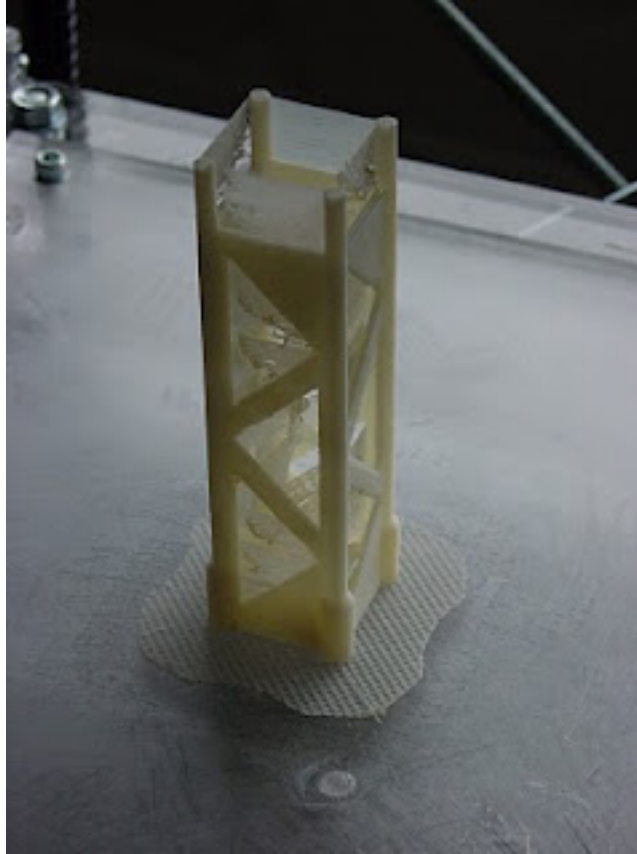

I was quite chuffed with my design. Clearing the female connectors on the bottom with a 5/32" bit took a matter of a few seconds and let me mate one of my test prints of the top of the module with the whole printed module. I immediately started printing up a second module. It finished up a few moments ago.

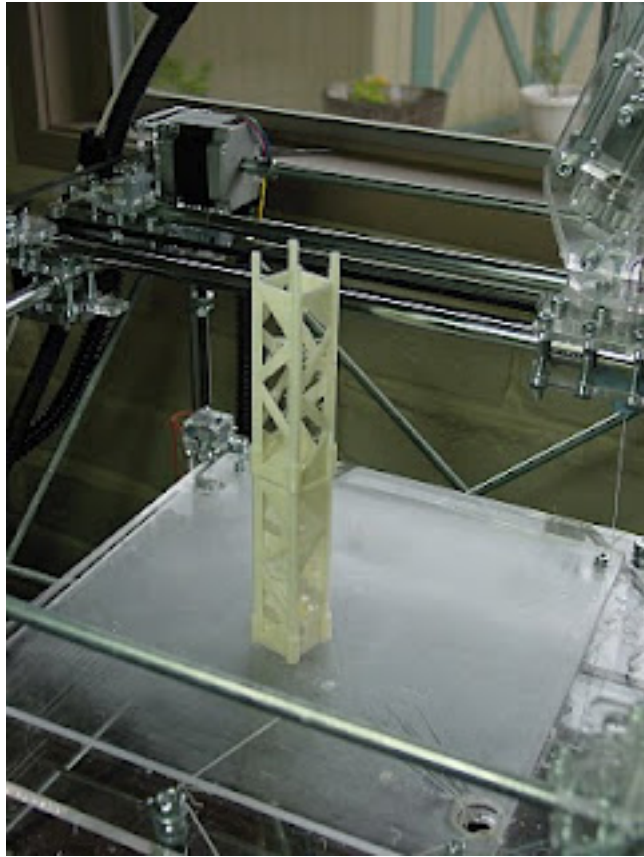

I think it's pretty obvious where this is going. I did a short clip of the print underway so you can get an idea of how fast it proceeds.

I am printing a third module now and plan on printing five over the course of the day. This evening after work, I plan on designing end caps for the assembly so that I can post tension it and then get an idea of how much deflection it exhibits under load for a 500 mm beam.

The lessons I've learned from all this is that if you design light and print vertically, viz, keep the cross-section on the xy print table small, you are going to get what are basically no-warp parts without going through the drama of heated print beds or turkey bags. it's worth thinking about.

Some crude load tests

Tuesday, 2nd March 2010 by Forrest Higgs

Bogdan began to question me about just how much stress these plastic beam modules could deal with. When he caught on that I was post-tensioning the beams he had no trouble accepting that they'd likely do the job. Just for fun, though, I went ahead and printed up four modules and assembled them into a 400 mm beam, post tensioned them and ran them through their paces. I was going to print special end plates, but it's getting late and my day job will be rather intense tomorrow, so I used one of the end plates from the last post-tensioning exercise with the herringbone rack column. For the other end plate I used a strongly designed washer that I printed for another purpose some time ago.

First, I did the same loading as last time, but this time the beam is 30 mm deep instead of 20 but much less heavily built



No deflection to speak of. No problem. That Maglite weighs two pounds and is point loaded at the centre of the beam.

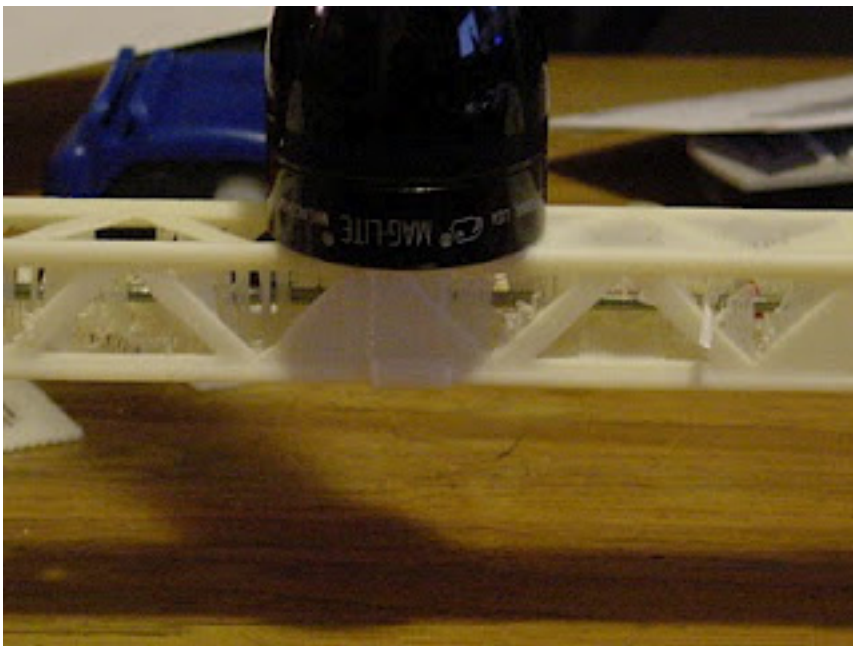
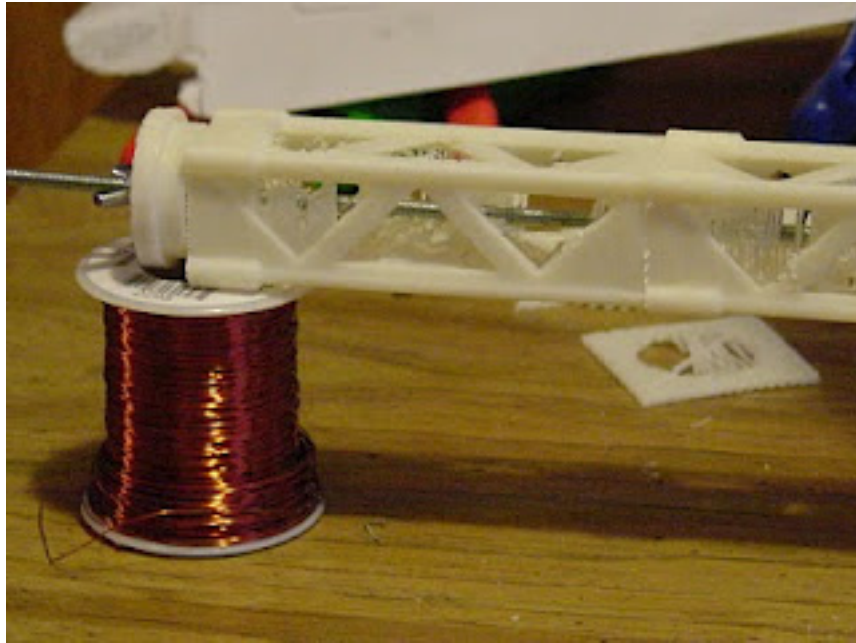

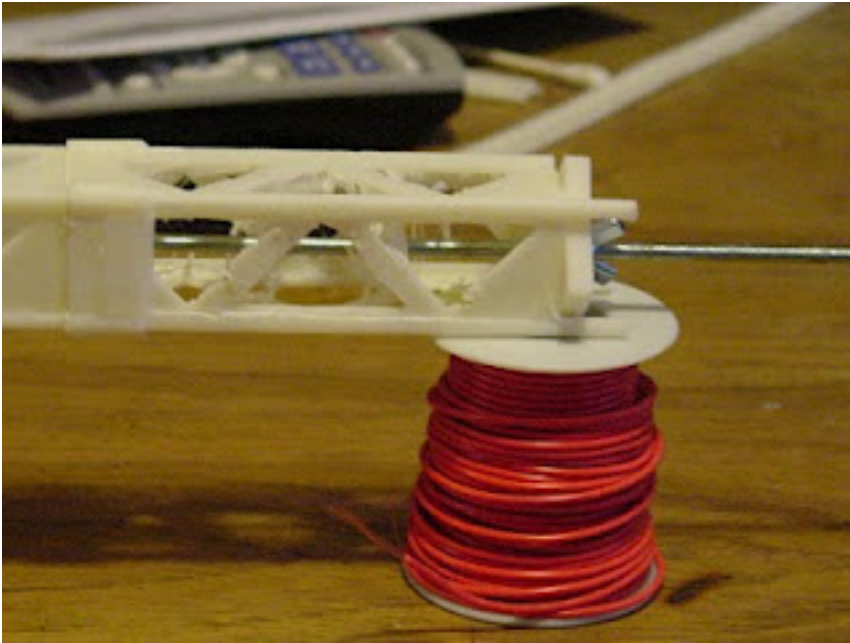

That was nice, but then I decided to get serious about loading, so I broke out one of my ten pound bar bell weights and partially distributed loaded the beam.



A couple of millimetres deflection, but again not much. I then threw another ten pound bar bell weight on for good measure.

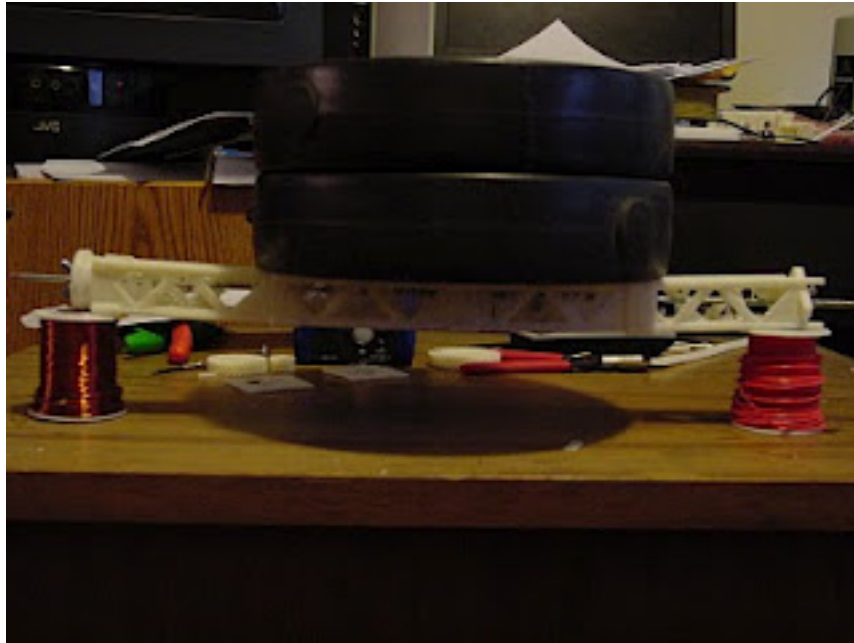

Now you start to see some serious deflection. Interestingly, the deflection is not because the beam is failing but rather because the lightly designed end plate on the right is beginning to fail. I replaced that plate with a heavily designed herringbone gear and repeated the exercise.



The deflection is better, but I began to worry that the shear stress at the ends of the beam, which I had planned to handle with purpose designed end plates is ill-applied to the light frame beam itself.

For a final exercise, I point loaded one of the 10 lb weights at the centre of the beam by blocking it with a couple of pieces of scrap ABS.



Guys, post-tensioning is a wonderful technology and very well suited to the scale that we are working at. Several people have suggested using ABS filament for the tension member. I think the thing to remember is that conventional wisdom in designing post-tensioned beams is that the tension cable or rod needs to be a LOT stronger in tension than the material it is paired with. In real life, you see post tensioning done with steel rod or cable and concrete. Concrete has effectively NO tensile strength. I personally don't think using ABS filament is going to give satisfactory results as a tension element in such beams. I use thin studding, lock washers and wing nuts because that is easy to work with and beams can easily be put in compression by hand. Anyhow, I think that if we want to we can get a lot of the structural steel out of our next generation Reprap machines and greatly improve the printed fraction using this approach.

Making Mendels

Friday, 5th March 2010 by Adrian Bowyer

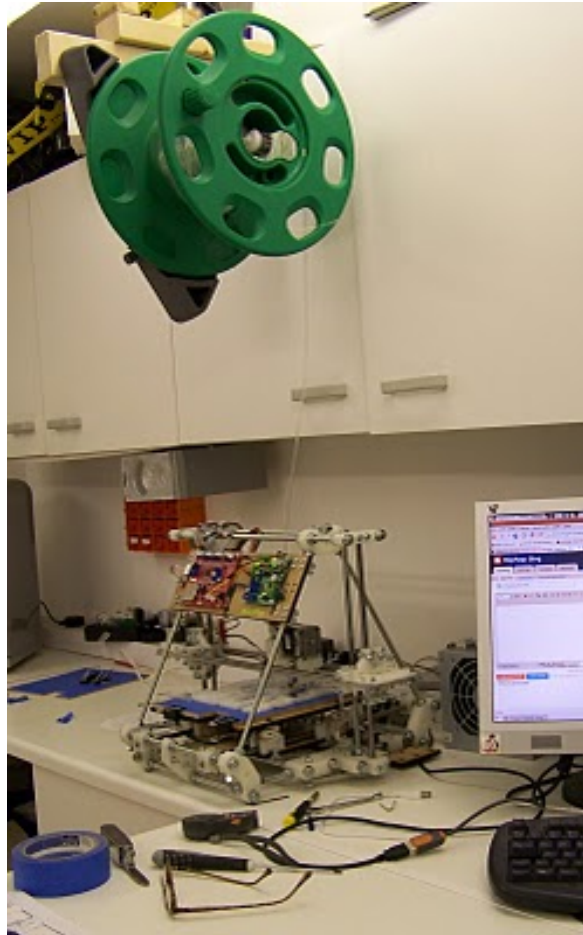

Production

Now that the Java host software deals with RFO files (under Linux at least - see below), it is Pretty Simple* to run a machine in batch production mode making whole trays of parts.

[* Insert superstitious incantation to ward off the Gods' reaction to hubris here.]

So, as some of you may have noticed, I've put a full set of Mendel printed parts up on Ebay. I reckon that they cost me about £40 to make (including my time, which I'd like to imagine is more expensive than it really is). I was aware that scarcity would push the bidding up beyond £40, so I will split the difference and put half into the project's funds where the donations and Google advertising currently go. The other half will go to - errr - me :-)

Following this one-off experiment, what I plan to do is this. The Mendels at Bath University will also shortly start churning out sets of parts too, and those will all go on Ebay when they become available with a buy-it-now price of £40. I want at-cost parts to be available right from the start, though I realise that they will be snapped up almost as soon as they go up for sale. At least

everyone gets an equal chance. I won't pre-announce availability, so people will have to watch Ebay to get them. I think this is fairest.

In addition, my wife, daughter and I will use our home machine (and it's decendents) to make and to sell sets at the market price (*i.e.* whatever they fetch in open auction) with a reserve of their cost-price to us (at the moment that £40). I look forward with interest to seeing what happens to the bidding when the passing blip of a buy-it-now momentarily comes into existence then vanishes...

Unusually for a profit-making enterprise, though, we hereby encourage everyone else to auction their sets of rerapped Mendel parts too. As you will be able to see from the Ebay link above, there is some dosh to be made.

Let's *all* spread RepRap and *all* make some money doing it.

---0---

RFO bug

If anyone can tell me where my RFO Java code is going wrong on Windows, I'd be very grateful. My problem is that I don't have a Windows system at home upon which to experiment. This, added to the fact that it works fine in Linux, makes debugging problematic...

---0---

Reel

Oh - the plastic-filament-holding reel in the picture is an old one for a garden hose. Simple; cheap; seems to work very well...

Reprappable electronics

Sunday, 7th March 2010 by Adrian Bowyer

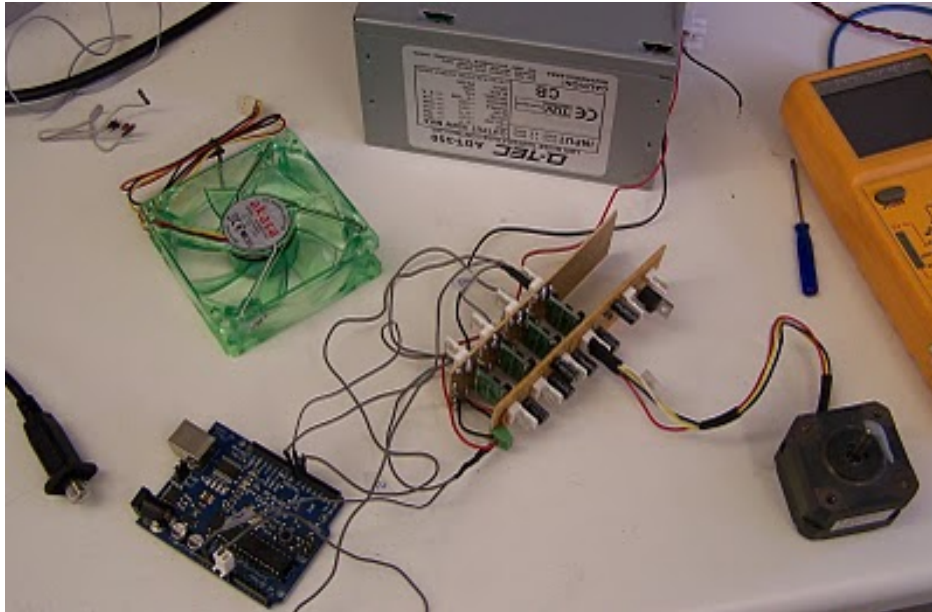

Rhys is progressing on both the conducting paste and the deposited low-temperature alloy route to getting RepRap to print circuitry.

So I have been working on a set of Mendel electronics that ought to be simple enough for the machine to rewrap when we get the capability.

My prototype is shown above (between the Arduino and the stepper motor). It is so simple that, in fact, it's quite easy to put it together using just two pieces of stripboard, which may well be useful in itself. It is driven by an Arduino Mega (not the Diecimila that you can see I was using for testing in the picture), and has all the drivers needed for a complete Mendel with one extruder.

Note that I have tested it on the bench, but not yet in an actual Mendel.

Here are the draft PCBs (not yet finalized):

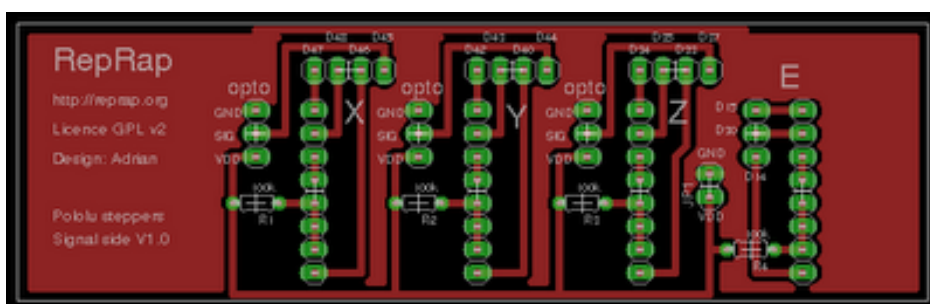

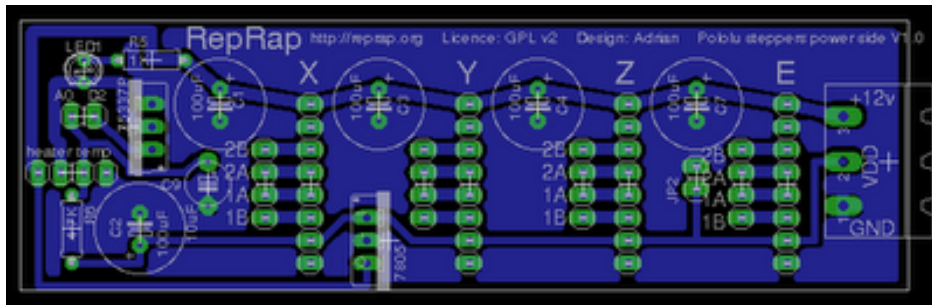

As you can see, they are single sided, and have no thin tracks. This means that it should be possible to create the equivalent by comparatively crude methods. They should certainly be cuttable by a Dremel head mounted in a RepRap, for example.

If you want more details, check here:

http://objects.reprap.org/wiki/Pololu_Electronics

Heated Bed and post-McWire Design Sprints! (Marathons?)

Monday, 8th March 2010 by Sebastien Bailard

Are you designing your own heated bed? Do you have a perfect one already?

Or have you simply eliminated several blind alleys? ("Wow, that magnesium really didn't want to stop burning, did it?")

Please come check out the [Heated Bed Forum Thread](#) and the associated [Heated Bed](#) wiki page.

Similarly, we're about to drop the McWire RepStrap like a slowly moving and generally unsatisfactory hot potato. And we want to hear what you are building instead as a bootstrap RepRap machine.

Discussion: [McWire Successor Forum Thread](#)

By the way - we're nearly done with the server stuff to really open up the RepRap project to user contribution*, in part by actually making use of the mediawiki that we're moving into.

In the meantime, let me remind you that you're already very welcome to go to <http://objects.reprap.org>, poke around, log in and click "edit", or create a new page for your RepStrap, post-mendel RepRap, RepRap-related or RepRappable project. Or simply *your* version of the ideal heated bed, RepStrap, and so on.

If you're not working on the Heated Bed or the RepStrap to beat all RepStraps, but you have a good project, try starting a new working group in the [Forum](#), (and a new wiki page).

* While at the same time, making sure that the Mendel docs still work and are somewhat stable. (That's the tricky part - I've always heard stability is supposed to be a good thing for documentation.)

Google's Summer of Code

Wednesday, 10th March 2010 by Sebastien Bailard

Hey All,

For those of you unfamiliar with Google Summer of Code (GSoC) it is a paid Google position offered to ~1000 students world wide to work with a open source organization as developers. The students are given specific tasks and a summer to complete them during which time they regularly meet with their open source group and google in working on their development task.

GSoC has an application deadline for organizations on Friday, March 12. I for one would be very happy if RepRap got in on this, partially as a student (count me in!), and partially as a RepRap dev where I see taking on full-time world-class student developers for free as having very few drawbacks



So heres what we need: Ideas. Ideas, Ideas, Ideas (Developers... no wait, wrong speech.). Anything you want, need or think would be cool on a RepRap is exactly what we want. I've set up a wiki page for this here:

http://objects.reprap.org/wiki/GSoC_2010

and will be linking the GSoC application to this page so go - get your idea on there!! We have just over 48 hours!!!

Rob Gilson

Bowden Paste Extruder

Friday, 12th March 2010 by Rhys Jones

As you may recall, the paste extruder I've been developing is based on the makerbot design which utilises air pressure to drive the paste from the nozzle. The reason for choosing this route was mainly that it allowed the extruder itself to be very compact, and thus make our lives easier when we get around to the head changer. However, as has been pointed out by various people, this does not offer the same control as say, a stepper motor driven extruder.

Last week, Adrian had an awesome idea to get the best of both worlds.... A Bowden paste extruder. I had a stab at making one yesterday. Basically, I used Araldite to set some PLA filament into the cavity of a bung, and used the standard approach of routing this filament through some PTFE tube to whatever drive mechanism we choose. Here I am testing it by hand, hopefully I'll get around to driving it with a stepper motor soon, but it looks promising.

Tiny ball-chain gears

Sunday, 14th March 2010 by Vik Olliver



I have finally managed to print tiny little ball-chain gears that work with 3.3mm and 3.5mm diameter ball-chain and still fit on the NEMA17's 5mm output shaft. The trick is to print the gears in two pieces.

As you can see in the photograph, I print two 4mm thick sections of gear and put them on the shaft with an M5 washer sandwiched in between. Make sure the teeth are lined up on both gears. This gives a channel to guide the ball-chain down the centre of the gear, and grips the sides of the balls adequately. As the gears age, it will also stop the balls grinding their way too far through the PLA, though I must admit that my experience with ball-chain Z axis gears suggests this will not be a major issue.

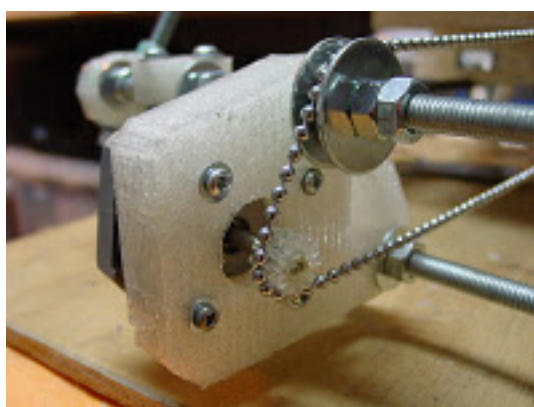

The gears themselves are designed to be "spiky", but the vaguerities of the printing and rendering process lop the spikes off and leave enough by accident to produce a functioning gear! SCAD and STL files are here: <http://www.thingiverse.com/thing:2009>

As the gears are stuck on the shaft of the NEMA17, and the original Mendel Y Motor Bracket is thicker than the length of the NEMA17 drive shaft, a new motor bracket is needed. Also, the ball

chain cannot take tight corners well, so a 608 bearing is mounted on the frame cross-member to act as a pulley. The same arrangement is fitted to the other side of the frame making the Y Idler Bracket obsolete. There are knock-on effects on the bed design and X Carriage which I'm still working around.

Vik :v)

RepRap in Singapore! (New RepRap User Group)

Tuesday, 16th March 2010 by Sebastien Bailard



Singapore RepRap User Group

From: Soon Wei

To:

SebastienBailard

Date: 03/15/2010 06:53AM

Hi Sebastien,

I am Soon Wei from Singapore. Happen to see some of your messages. I just meet Xiang Hui few hours back. I would like to start a Singapore RepRap user group and start to build the First Singapore RepRap. (If we are?) FYI, I am an Elec Electronic Engineer and I've used a few Atmel MCU b4 so that is not a big issue. I should be able to source for the raw mech material except the RP connectors... I have access to a small lathe, but i foresee the 0.5mm on the barrier making is a challenge. Aha too excited and forgotten my goal. Would it be possible to start a RUS for Singapore? Thanks in advance.

-Soon Wei

No problem. Good luck and happy RepRapping!

Singapore RUG Home Page

Singapore RepRap User Group Forum/Mailing List

-Sebastien

p.s. to rest of the RepRap-using world:

We have 150+ or so other RepRap User Groups

So if you want to make a RepRap, do check them out.

No peel, no warp, no backlash

Friday, 19th March 2010 by Forrest Higgs

I got Slice and Dice working well enough to let me do some serious R&D. After a side excursion with partial STLs of hands and naked ladies, I got back to work on the herringbone rack and pinion technology.

My first exercise was to see if I could print single herringbone pinions without having a lot of meltdown problems. Skeinforge had a lot of problems in that regard. In fact, Slice and Dice let me do that.



I printed it pretty much solid for strength and paused it for a couple of minutes midway through the print and let it cool down for a few minutes. No problems. This one was printed with 0.25 layers. Next came the rack. I decided to use the exercise last night to press the limits of Slice and Dice. I figured that I ought to be able to print a 250 mm diagonal layout rack. That let me find a half dozen limits bugs in the S&D code and get them cleared away. I also decided to see if I could print a useful 0.1 mm layer.

In fact, I could. Here we are about halfway through the print.

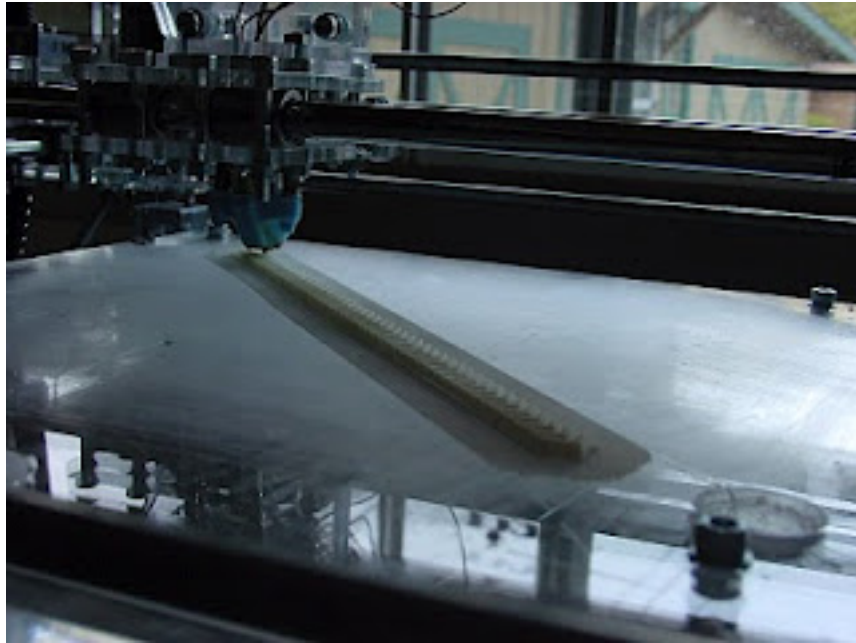

It took about an hour, by the way

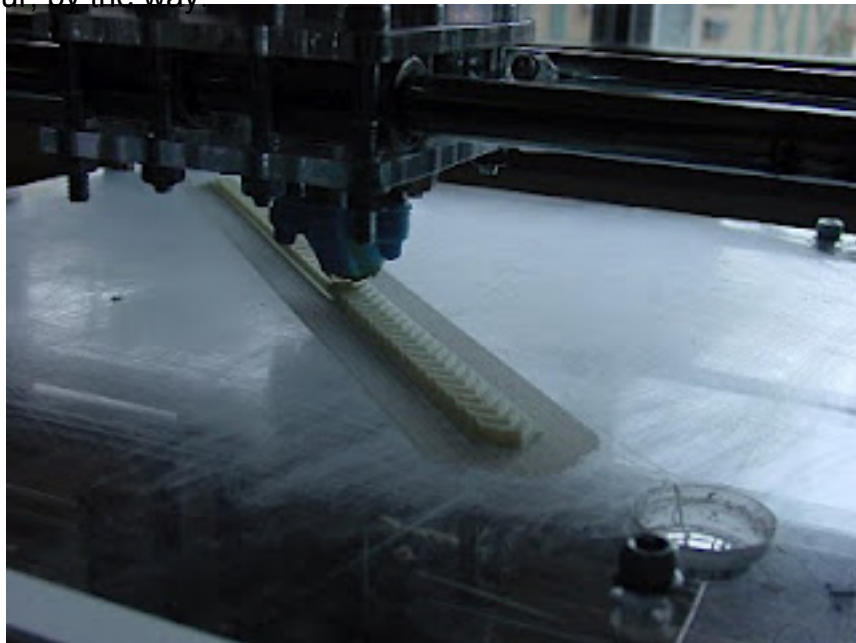

Here it is, complete.

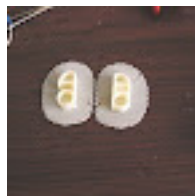

And a closeup of the teeth.



For some reason the extruder is not shutting off between layers. While that is easy enough to clean up with side cutters, I'll be diving into my code to see if I can sort that out in the next few days.

The pinion gear mates with the rack with no backlash.



I didn't make much of an effort to clean up the pinion which you can see in this outdoor pic.



I've found that the colour rendering is always better outdoors.
Finally, for those of you who haven't a sense of scale looking at the Rapman print table.



My next task will be to figure out how to put the pinion on a printed, extended shaft so that it can be secured from both sides and mate with the short axled NEMA 17 that will drive it. Then it will be a matter of integrating my Pololu Allegro 4983 microstepping driver board into my I2C bus and driving the thing from my Microchip 18F4550 uC board.

Yet Another Geared Extruder

Sunday, 21st March 2010 by Adrian Bowyer

[RepRap Geared Extruder](#) from [Adrian Bowyer](#) on [Vimeo](#).

I wanted to design a single extruder driver that could

1. Be bolted to the X carriage of Mendel and run as a normal extruder,
2. Be mounted somewhere at the side and drive a Bowden extruder, and
3. Be mounted somewhere at the side and drive a Bowden paste extruder, [as outlined here](#).

This is my first hack at a solution.

This design was inspired by Wade's neat geared extruder that [you can find here](#).

Features:

1. 55:11 gear ratio means that the motor runs on very low current
2. No hobbing or knurling needed to make the filament driver
3. Torque transmitted using a wing nut, giving low stress on rewrapped gears
4. Uses the same 624 bearings as the rest of RepRap Mendel
5. Designed to work at higher extrude speeds than the standard Mendel extruder, giving shorter build times (I hope...)

Though I say it myself, it does run very smoothly...

[Details are on the RepRap Wiki here](#).

Stacking slices to make simple boolean unions

Sunday, 21st March 2010 by Forrest Higgs

Art of Illusion is a pain in the neck to work with. On the other hand it has the shortest learning curve of any 3D modeling package I've ever encountered and is simple enough for an eight year old to operate.

When I say pain, the primary problem is the boolean ops module. Aol does boolean ops with triangular mesh defined solids. Doing boolean ops on mesh defined solids is a brass bound bastard of a problem. There is a tendency to condemn Aol because its boolean ops module isn't very good. When you go out and start looking at other 3D modeling packages, commercial and open source, you begin to notice that virtually none of them, or all of them for all I know, can import mesh defined solids formats like STL. When you look at how these apps do boolean ops you soon find that the objects you can define have to be very carefully defined out of shape primitives and that these primitives, suitably adjusted by size, orientation and position parameters are what go into the boolean ops module.

That's cheating.

Before I get off into a pointless rant about that, let's get back to the problem I was addressing. Aol is rather simple to write special purpose scripts for. Recently, I wrote one for generating herringbone racks. It was a pain in the neck to design that script, but once it was done it worked perfectly. The rack has a 5 mm flange on either side.

When I set about to design a beam into which that rack could slot, however, I discovered that it would be a very good idea to have some space between where the rack stopped and the beam started. To do that I needed to add a wider, somewhat thicker slab under the rack. I had two choices. I could either go back and rewrite the script {shudder} or I could glue that rack onto the heavier slab using a boolean union op, sort of like this.

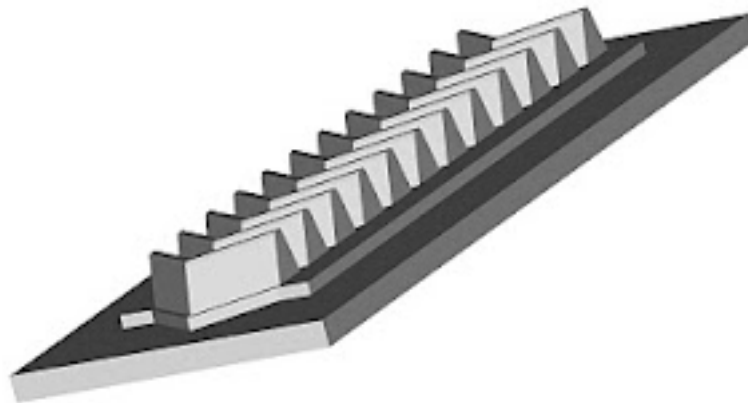

While Aol would let me merge the slab and the rack, when I went to do a boolean union op, it simply wouldn't let me. Not nice. It was infuriating to be able to look at what I wanted on the Aol display and not be able to turn it into an STL.

That got me to thinking. Basically, all I wanted to do was put the rack on top of the slab. If I put the slab through Slice and Dice to create a set of slices and then repeated the game with the rack, keeping the same alignment, it would be a simple matter to just stack the rack slices on top of the slab slices. Of course, when I set out to do that I unearthed several previously unsuspected bugs in the Slice and Dice code which took me most of Sunday to chase down and fix.

It works now, though. Slice and Dice can do a simple boolean union between two objects by stacking slices. I've tested the code and ran it through the whole exercise in the morning. And there it is.

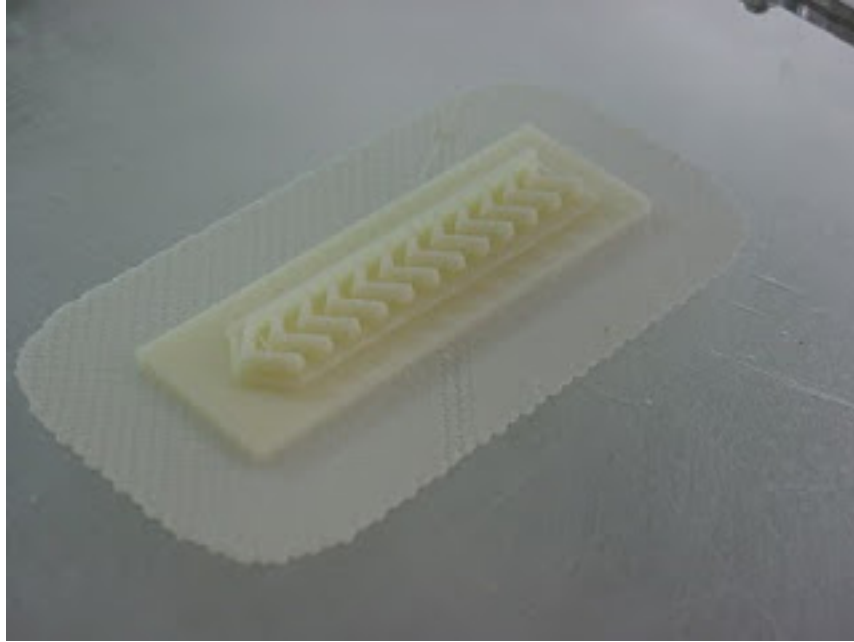

The slab is 80 x 25 x 2 mm. The slab and flange are 100% fill. I printed with 0.1 mm layers using a 0.3 mm extruder at 16 mm/sec. There was no corner curling or warping at all. This print is extremely strong.

Let's Go To The Faire!

Thursday, 25th March 2010 by Sebastien Bailard



RepRap is going to the
2010 Bay Area Maker Faire
May 22nd and 23rd, 2010,
San Mateo County Event Center, California.

RepRap being:

1) Folk showing off their machines!
1a) You!

2) Folk selling machines, parts, kits, sundry subsystems, supplies like plastic filament, electronics, steppers and so on.
2a) You!

3) Folk who are still building machines!
3a) You!

So if you've like to come out and help table, or if you're planning on selling stuff, or if you think you'll come by and say hi! then

Swing by and introduce yourself in this forum thread!

We're hoping for lots of people. (How many RepRappers are out there, anyway?)

Best of both Worlds

Tuesday, 30th March 2010 by Bogdan Kecman

I'm using RapMan 3.0 for a while now and it is a great machine. I did tweak it a lot, but however I tweak it, and however I change more or less important parts or the way some things work on this Darwin based kit the few things I cannot change and they bug me big time. Major issue I have with it is size. And as I'm printing a lot of PP/HDPE there is no way I can use that big table (PP warps 10 times worse than ABS)...

This is the left third (almost half actually) of my desk:

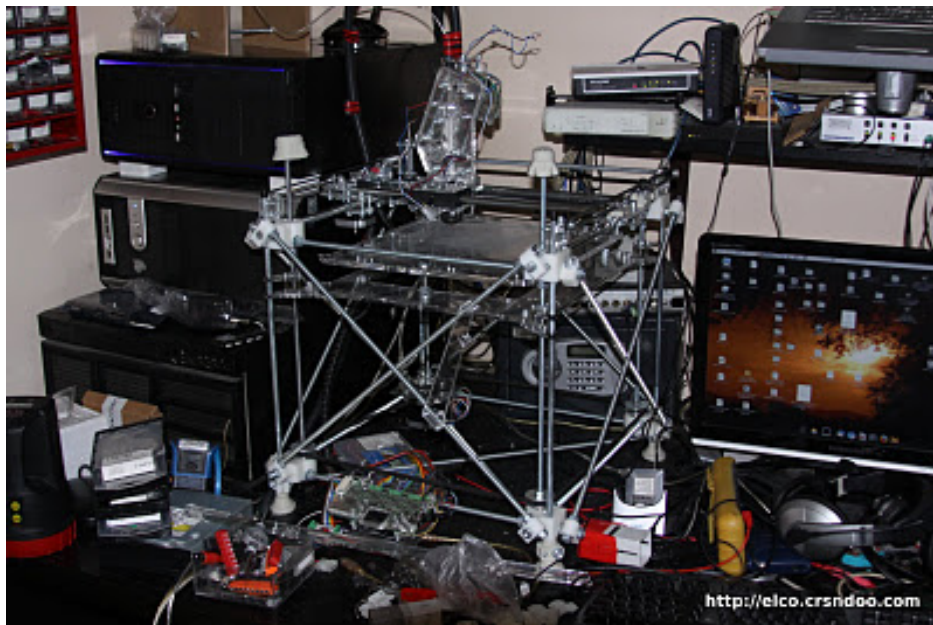

From RapMan

now it would be cool if I only used this desk for printing but that's not the case. I found solution in Mendel, the second generation reprop machine. Mendel is super cool reprop, it has small footprint, it requires less power... but all the extruder designs I seen for Mendel are not comparable to those of rapman's designed and sold by BFB. Getting your nozzle to 260C and extruding at high pressure will render PTFE tube based extruder tips unusable, and standard extruder drive has no way of applying enough pressure. dr. Bowyer recently published YAGE that IMHO had potential to push with enough strenght (I did modify the drive a bit and added some very sharp 2mm pitch pulley as drive instead of that M4 inset) but still, the PTFE tube design and 260C don't really go together, not to mention glued PTFE and high pressure so I looked at the hot end piece of rapman's extruder. BFB sells hot end kit for some reasonable price, and as I have few spare and I know this hot end can take a beating (the first one extruded kilograms of different filaments and is

still in prime condition) I decided to give it a go.

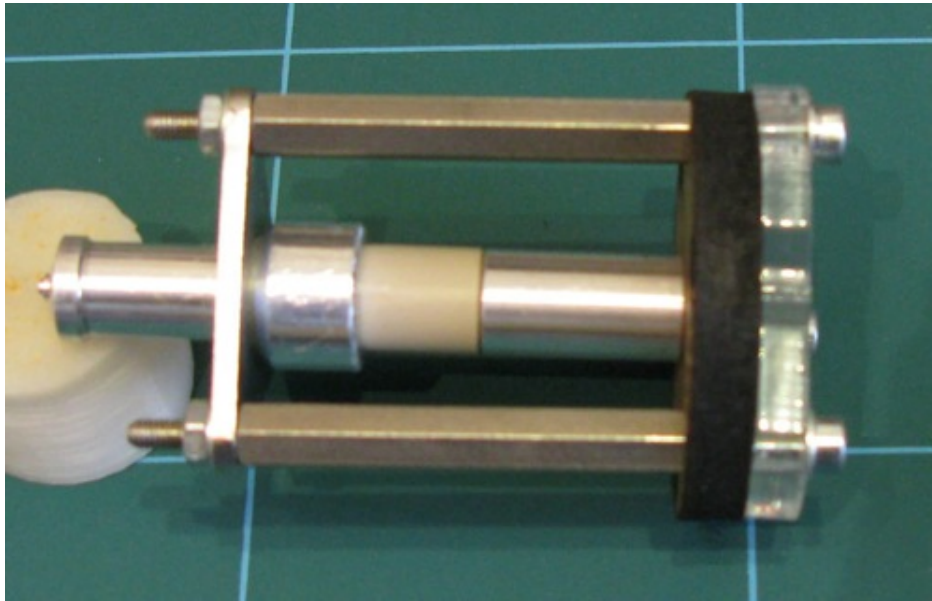

BFB hot end is "wide", it is ~80mm diameter so I had to change the x-carriage so it can fit.

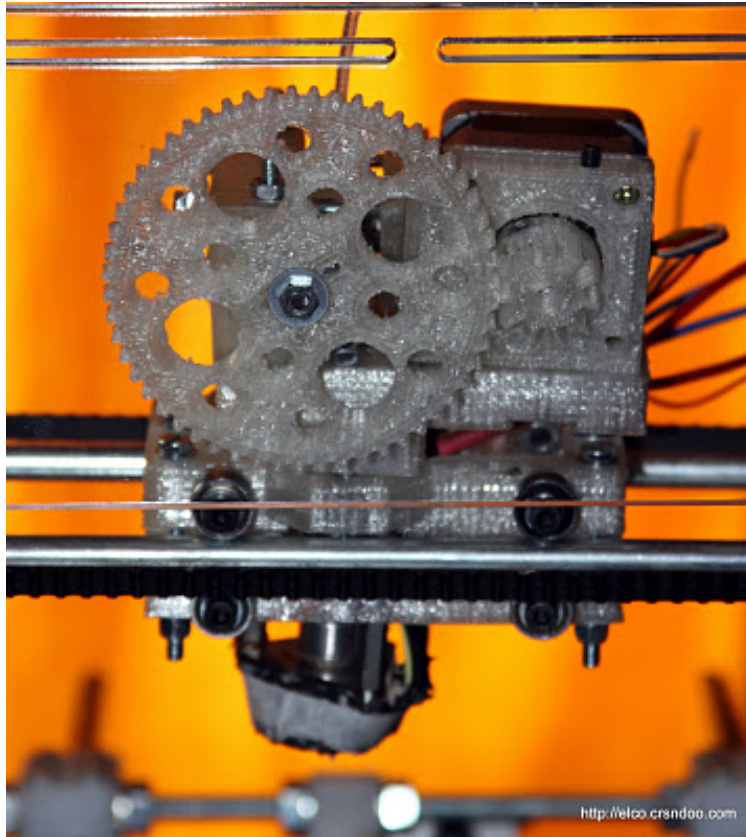

From MENDEL

I heated the hot end to 270C and let it be hot for 2h before I checked if the x-carriage (made out of PLA) is getting soft - and, to mine surprise, it was not. I was afraid I will have to print the x-carriage using ABS or HDPE and that requires heated bed that I still don't have.

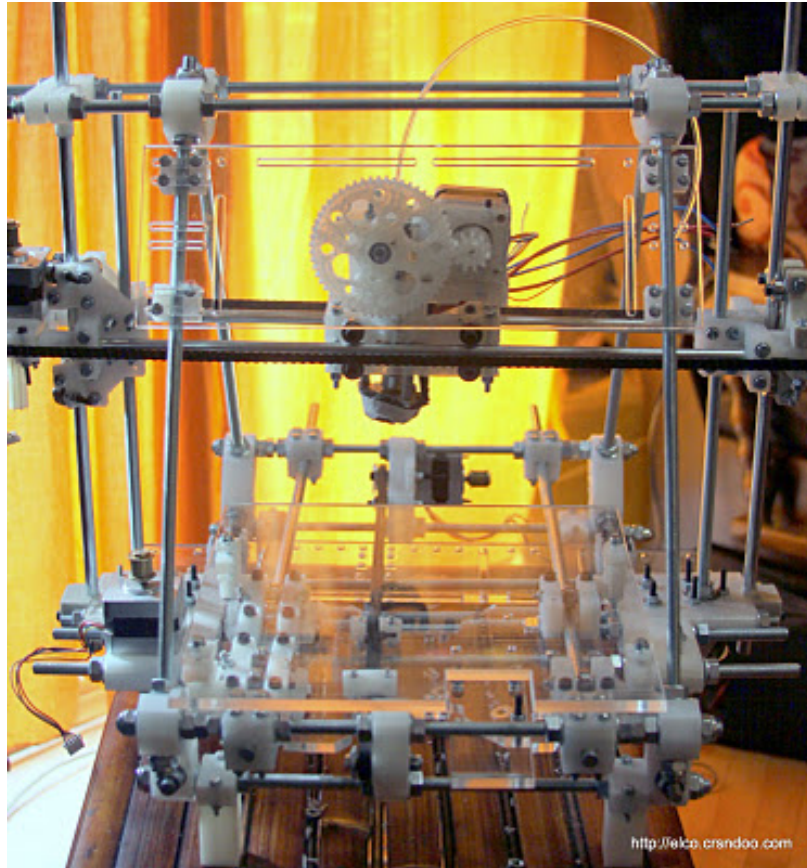

From MENDEL

Testing the extruder, it is bit slower then original bfb extruder (because bfb one is 1:1 and this one is 5:1 and because I'm using some second hand stepper of unknown manufacturer) but is pushing filament at more then 2-3mm/sec of filament (not the 0.5mm but the 3mm filament) per second and that's what I was aiming for.

Now I need to try to modify the bfb pcb to run Mendel so Mendel can also be stand alone printer and I can truly have best of both Worlds, but for now, Mendel is, with this new powerful extruder, ready to replace the dear chunky rapman from my desk (and rapman, as stand alone printer, can go to back room)

Our Extruders Hardly Ever Catch Fire

Tuesday, 30th March 2010 by Vik Olliver

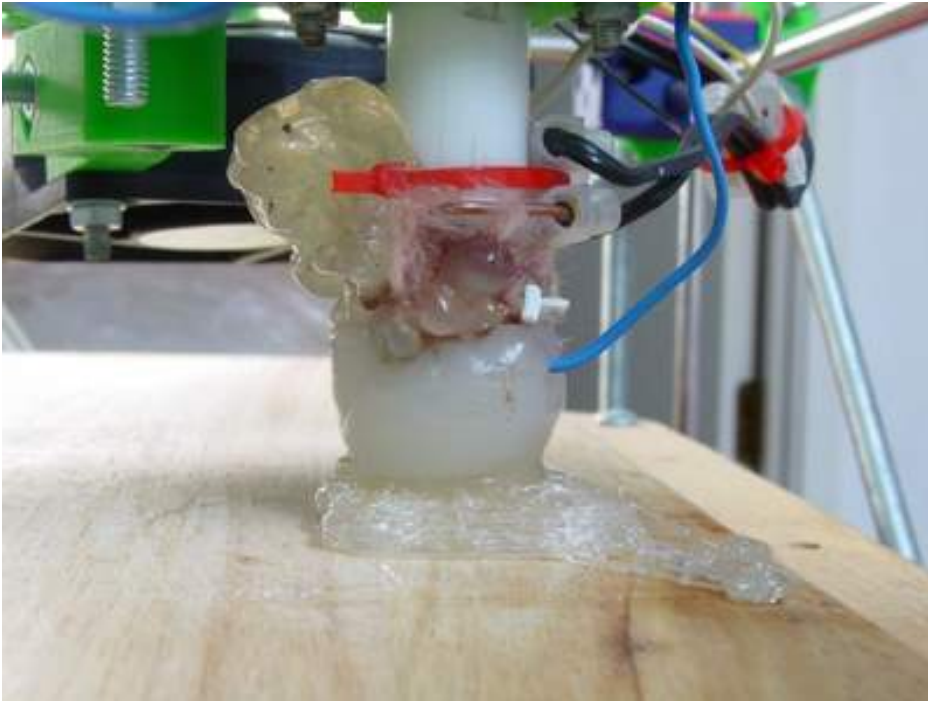

Well, not much these days ^{*}. But they do frequently throw tantrums, and some of those get close. So for those RepRappers who fell like sharing in a more "modern" context, we bring you the "RepRap Tantrums" [Facebook group](#). This is a place where you can post pictures and videos of extruders engulfing themselves, particularly artistic birds' nests, or an absolutely spectacular huge printout - with an extruder driven through the middle of it.

And now a seasonal warning for you to all check the batteries in your smoke alarms. Thanks.

Vik :v)

^{*} Every software hack in the world wouldn't have stopped the first extruder fire I had, when an overheating TIP122 dribbled solder onto stripboard, permanently wiring the heater to 12V.

[No Title]

Thursday, 1st April 2010 by Sebastien Bailard



MINER CANCELS DRINK; INTERRUPTED BY CARP.

Hello all!

A number of people have started to help out with the RepRap wiki.

Many do so just by keeping an eye on: Recent Changes and then just chipping in and fixing stuff.

I believe the wiki may have just gone critical a few days ago and we've only now started to notice.

We also have a pretty healthy and, happily, largely self-moderating forum here:
<http://forums.reprap.org/>

And we are thinking of hosting an efficient and ethical marketplace. <http://reprap.org/wiki/Tender> although it may be more trouble than it is worth.

We currently have an highly inefficient, but satisfyingly ethical marketplace in the form of our For Sale Forums.

So, if you you are interested in helping out RepRap, please contribute in the way you see best, and if you are interested in becoming a RepRap forum administrator, I think that is great, but please consult this helpful Training Simulator (More Information)

Also, please note, a number of you are choosing to make RepRap a lifestyle choice by selling RepRaps and RepRap parts, and are thinking of going "pro". We think this is wonderful, and indeed one of the points of the RepRap project, but please note that you're participating in a dynamic and evolving marketplace with a number of traps for the unwary. (Further Reading).

Please don't forget: we're a Wiki!

You are welcome to log in and click "edit" whenever you see a typo. We encourage you to create a new page when you see something 'missing', or just because it is fun!

Hot copper and PLA

Saturday, 3rd April 2010 by nophead

Acting on a suggestion from Vik, I have found that PLA can be extruded onto copper clad board and, if it is hot enough, it sticks very well. I have to flex the board to remove it. 55°C is too cold but 130°C works well. I haven't tried anything in between yet.

Assuming PLA will resist PCB etchant, this could be a way of making PCB's without a laser printer, albeit quite low resolution. With 0.3mm filament squashed to 0.24mm a single line would be 0.36mm wide, which is 14 thou.

It also seems like a good bed material for making PLA objects on.



More details here: hydraraptor.blogspot.com/2010/04/cu-pla

Fab At Home

Sunday, 18th April 2010 by Adrian Bowyer

We've just had a request from the Fab@Home people to blog the fact that they have redone their website and are launching their version 2. Happy to - details are [here](#).

Where it all began...

Monday, 19th April 2010 by Adrian Bowyer



Your correspondent on holiday in Ironbridge in Shropshire. This is where Abraham Darby first managed to smelt iron with coke (rather than charcoal), an invention that has as much claim as any to have started the Industrial Revolution.

Though, in reality, that revolution started more or less simultaneously in many places in England, you really get a sense of the historical significance of it here. In particular you can see how, in what is now a sleepy small town, the late eighteenth century must have felt just like Silicon Valley did in the 1980s.

In the reconstructed village set sixty years or so later at Blists Hill just up the road, they have a number of working stationary steam engines - my third favourite machines after tall ships and (of course) RepRap.

Definitely worth a visit.

RepRap Talk and Demonstration in Cardiff, UK

Thursday, 22nd April 2010 by Adrian Bowyer

Adrian will be giving a talk to the British Computer Society on RepRap in Cardiff on 13 May. It's free for anyone to attend. [Get details here.](#)

RepRap the Lawgiver...

Saturday, 24th April 2010 by Adrian Bowyer



Many people (including me) are interested in the legal implications of the widespread take-up of home reprapping.

Now, IANAL, but I have a chum, Simon Bradshaw, who is. He, Patrick Haufe and I have written a paper on home 3D printing and the law. The paper is based on Simon's LLM dissertation. It has just been published by the journal ScriptEd.

[You can read it here.](#)

Bay Area Maker Faire Reminder!!!

Thursday, 29th April 2010 by Sebastien Bailard

A promotional banner for Maker Faire. The top section has a blue border and contains the text "Maker Faire" in large red font. Below this is a yellow section with the text "Build. Craft. Hack. Play. Make." in black and red, followed by "May 22 & 23, 2010", "Bay Area, CA", and "San Mateo County Event Center" in black. To the right of the yellow section is a photograph of a 3D printed robot. The bottom section has a blue border and contains the text "makerfaire.com" in red.

Maker Faire

**Build. Craft.
Hack. Play.
Make.**

**May 22 & 23, 2010
Bay Area, CA
San Mateo County
Event Center**

makerfaire.com

If you're planning on going to the Bay Area Maker Faire with RepRap, please check in if you have not already done so.

Right now it looks as though we'll have 14-16 people and 5- 6 machines.

-Sebastien

Board Supports

Sunday, 2nd May 2010 by Vik Olliver

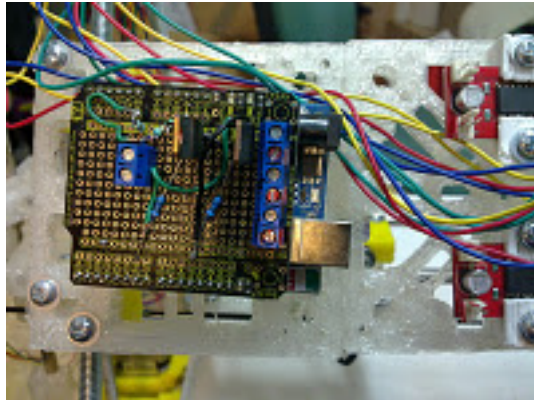

I got irritated by the thought of a large chunk of wood that could be replaced by printing. So I'm tinkering with these modular panels about 100mm a side, scaled to fit the frame 3 abreast using the same fittings as their wooden counterpart.

Here you can see an Arduino with a simple prototype board on it. This holds 2 of TIP122 drivers for the heater and an experimental DC extruder. Alternatively it can hold 2 EasyDriver stepper controllers. Basic, but hopefully reliable.

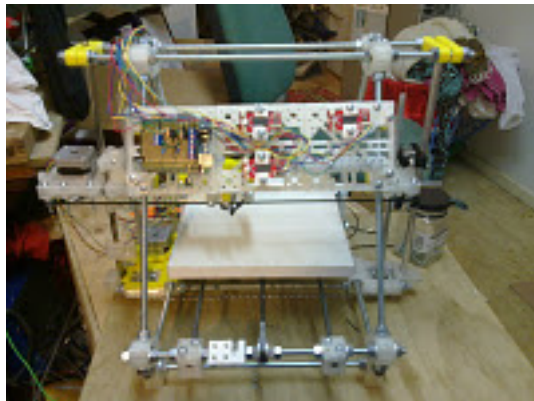

They interconnect with 2xM4 16mm screws and trapped nuts. Objects can be anchored on pillars with 40mm M3 or M4 screws, or against the module's surface with 30mm ones. Here are some preliminary prototypes. I've attached them to the current "Simplified Kiwi Mendel" known more affectionately as Lemon Slice.

Speaking of slices, I caught my hand on a falling mandoline and have to rest my left hand. fortunately thumb works so I can sneakily enter blogs from bed on my phone...

Vik :v)

A Heated Bed for Mendel

Wednesday, 12th May 2010 by Adrian Bowyer

A little while ago, Nophead made a Dibond heated bed. Dibond is a sandwich of LDPE between two aluminium sheets, and is very flat.

I thought I'd have a go too. Instead of the TO220 resistors he used, I used nichrome wire taped down with Kapton on the back.

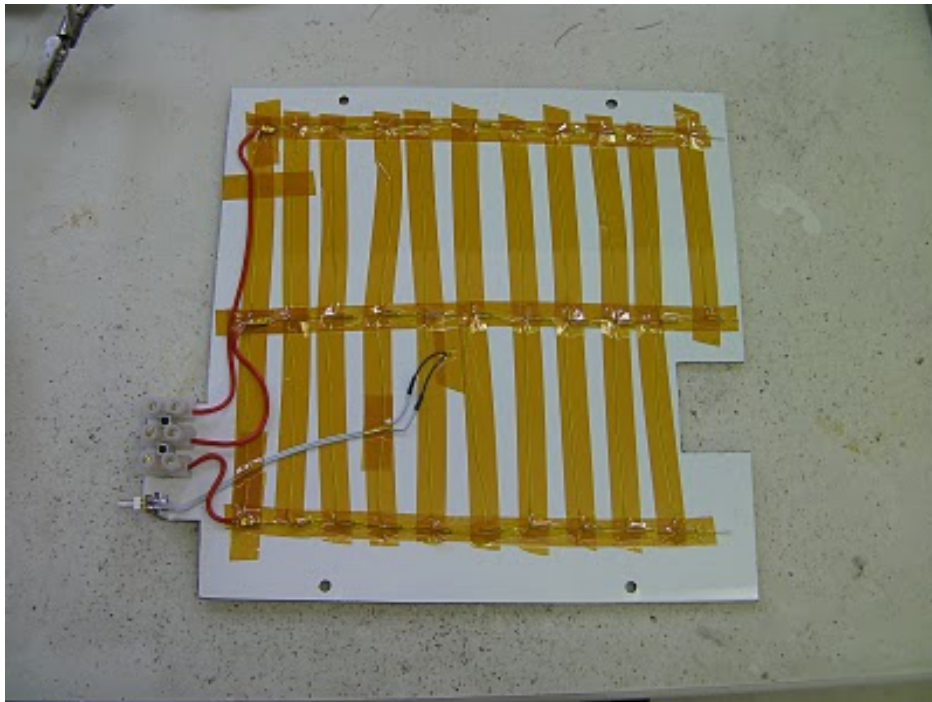

Then I insulated that with crack-filler foam, cut down to about 10mm thick with a bread knife.



It seems to work well. Here are the larger Mendel parts printed on it in PLA with it set to 50 °C. Their bottoms are f. as pancakes.

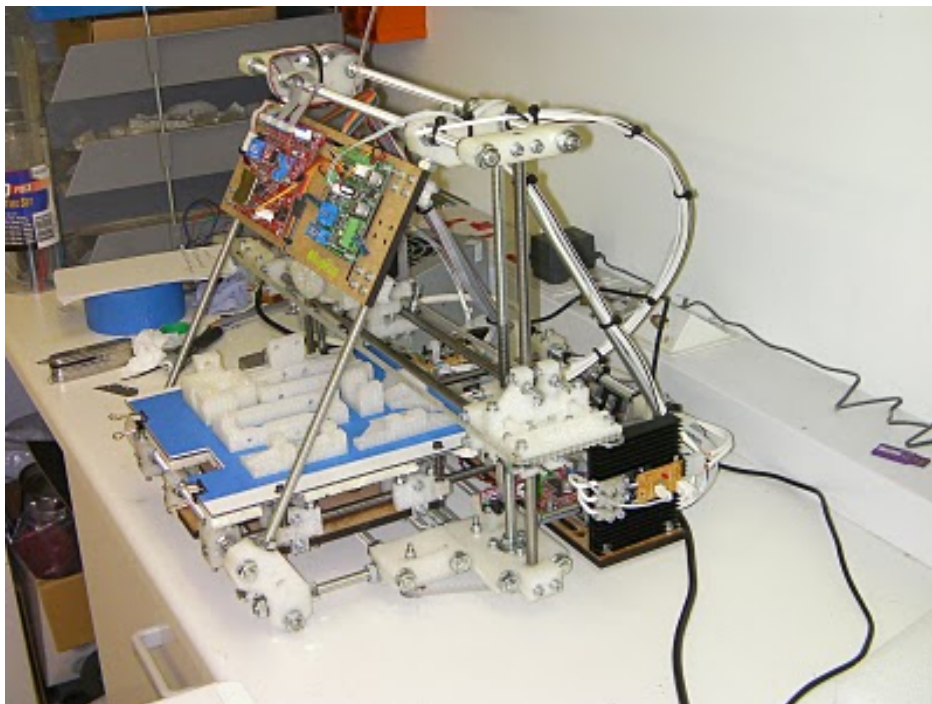

I used a piece of ordinary aluminium sheet clipped on the top with bulldog clips to give me a removable tray with good thermal conductivity. That is what has the blue tape on here. The tray is flexible, but the Dibond holds it flat.

I thought it'd be clever to use the 5v supply out of my PC PSU, as that's not being used for

anything else. But the current (16A) is a bit silly - connectors and so on get warmish. For the next one I'll run it at 12v and about 7A.

Dibond is rated up to 80 °C, which means it's fine for PLA, but might not get hot enough for ABS.

I've integrated it into the host software, the G Codes, and the firmware and updated the copies in the repository. I have to go to Cardiff tomorrow to give a RepRap talk to the British Computer Society, but I hope to put all the details on the wiki over the weekend.

Quick hot bed temperature controller...

Saturday, 15th May 2010 by Bogdan Kecman

I received some aluminum plates (one for my rapman and other for my mendel) and some 50W resistors (still waiting for the 100W ones) tied it all together and it worked just like Chris shown on his super cool [blog](#) :, anyhow using the max power (~12A ~500W) I can push to the bed it can overshoot the max temperature those resistors are specified to handle so I needed some way to control it. Initially I used the simple thermal switch (like you can see in TA oven) but as I want to be able to change the temperature from the motherboard I decided to replace it with small electronics.

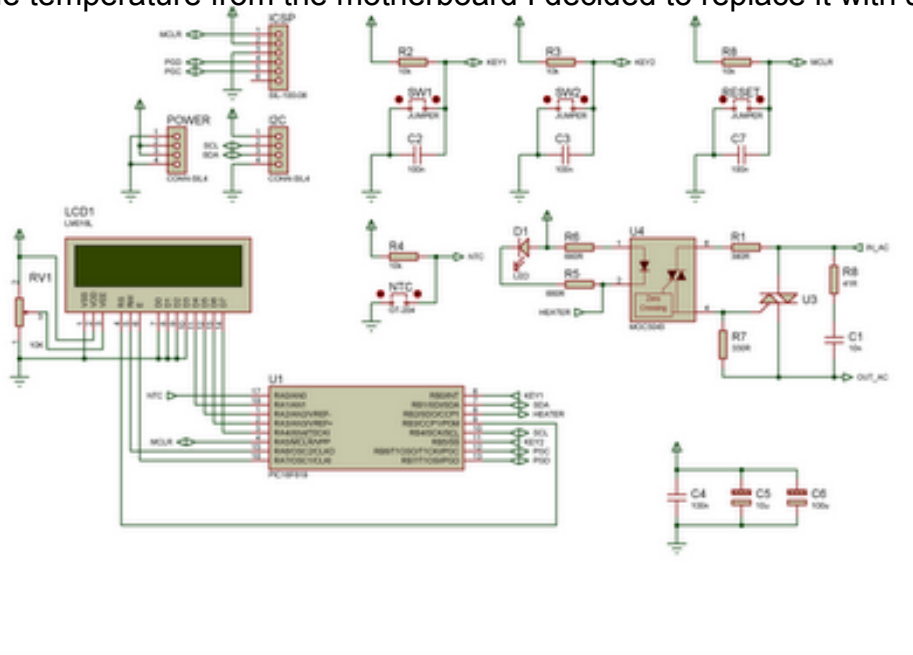

I do not have a SSR lying around but I have bunch of "no name / no marking" 25A 600V triac's that are perfect for the job, I used the MOC3043 (optocoupler with triac output and zero crossing detection) to separate the electronics from the AC going in to heat bed (I'm using 41VAC), the microchip PIC16F819 is used to drive the LCD, read NTC and work as I2C slave. NTC is connected with 10K resistor to maximize reading range between 20 and 180C. NTC used is same one from BFB hot end's (GT-204).

"firmware" is written in PICC C, it takes ~70% ROM and ~40% RAM so there's room for more functionality if needed. I2C slave address is 0xAB but it can be changed, first 2 addresses (0 and 1) are read/write and contain target temperature for the heat bed while second 2 (2 and 3) are read only and here you can read current temperature of the heat bed. To avoid float math, the temperature is stored as *100 value. When turned on - the controller reads last stored temperature from the EEPROM (locatio 0 and 1), when both key's are pressed the current target temperature is stored in EEPROM. You can both change the target temp via i2c or using key's (whatever happens last).

Source (PICC C file) is available here.

An Open-Source Scanning Tunneling Microscope

Thursday, 20th May 2010 by Adrian Bowyer



Yesterday I ran into Jochen Klingelhofer of [Lab Minds](#). He introduced me to the SXM Project - a project to distribute an open-source scanning tunneling microscope (already working) and a scanning force microscope (under development).

How cool is that? Many of the parts are eminently reappable too.

[For details follow this link.](#)

Just to whet your appetite, here is a picture of a 4 nm square area on the surface of a piece of graphite made with the microscope:

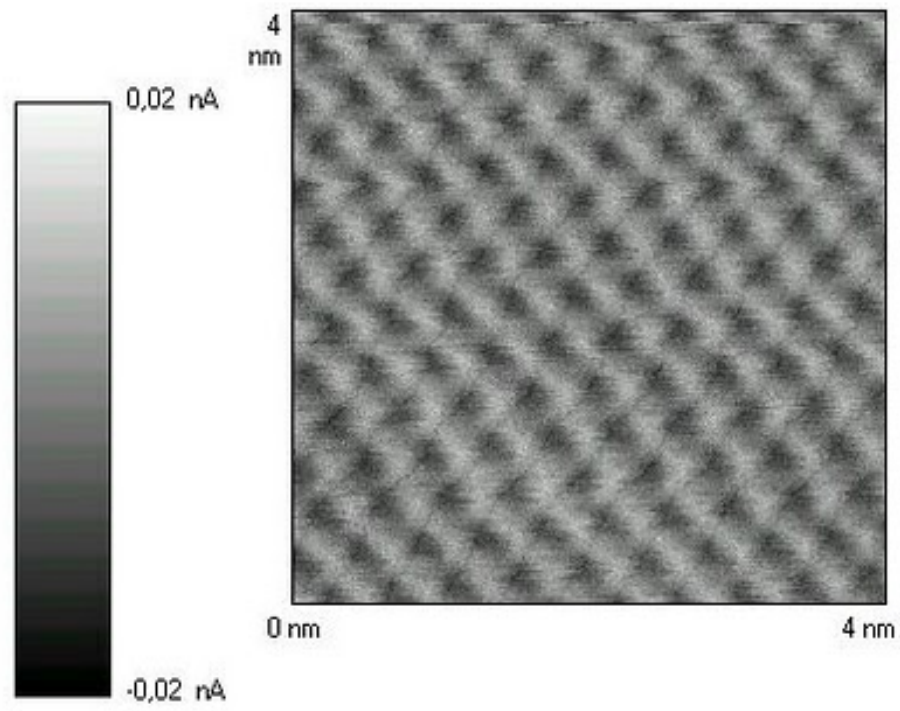

HOPG

Note the atoms...

Mendel Variations and Lasers!!!

Saturday, 22nd May 2010 by Sebastien Bailard

I've been having fun watching the cambrian explosion of variations on Mendel.

This one is particularly significant.

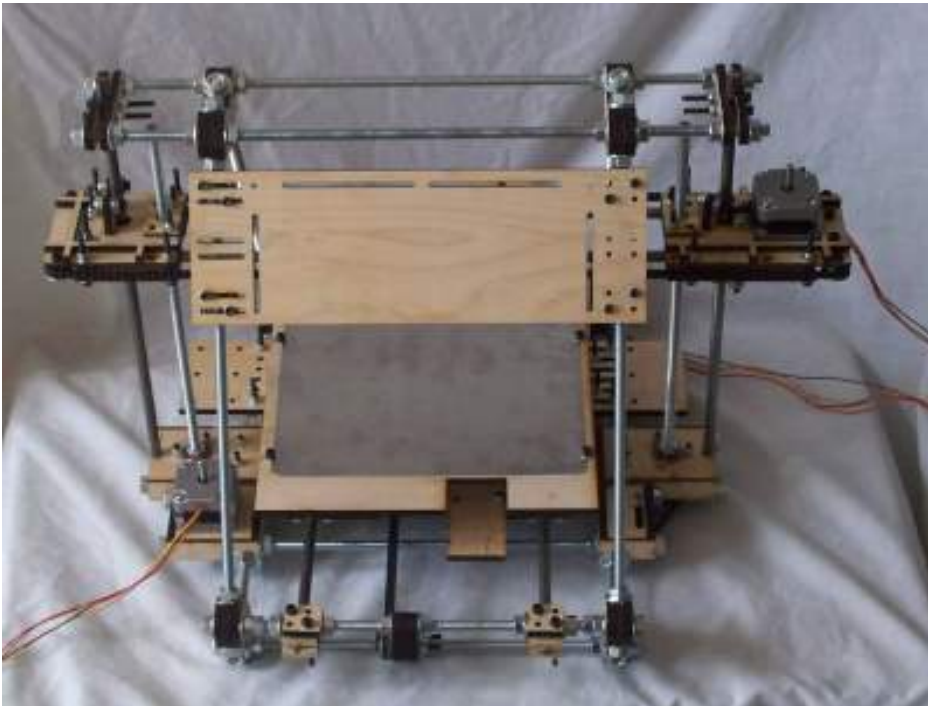

LaserCut_Mendel by Kimberly and Lambert Andrus of TechZoneCommunications.com llc.

LaserCut Mendel has the same metal hardware and other paraphernalia as vanilla Mendel. But now you can make one in the privacy of your own home using your laser cutter!!! (If you don't happen to have a laser cutter, you can buy a LaserCut Mendel from Kimberly in the RepRap For Sale Forum, or come out this weekend to the Bay Area Maker Faire, and buy one from her in person).

Kimberly Anders also sells a version of the RepRap Gen 3 Electronics, the Generation_3_Electronics - Tech_Zone_Remix. These boards have generated quite a bit of interest in the community and you can buy them in this thread in The RepRap For Sale Forum. In the best RepRap traditions, our fellow users are helping document them here: Generation_3_Electronics/Tech_Zone_Remix/How_to. (Discussion/Support)

RepRap Talk - Bogota

Tuesday, 25th May 2010 by Adrian Bowyer

If you're a reprinter in Colombia, you should know that Cristian Pe±aranda is giving a talk and demo of RepRap at the Campus Party Colombia, which runs from 28 June to 4 July.

Details are at: http://www.campus-party.com.co/Software_Libre.html

Major New Scientist RepRap Article

Saturday, 29th May 2010 by Adrian Bowyer

The replicant

RepRap is a desktop 3D printer capable of making plastic objects. Since many of RepRap's parts are made from plastic and it can print those parts (shown in red), the machine is partially self-replicating

©NewScientist

RepRap downloads the 3D design of an object then prints it in molten plastic, building the object up layer by layer

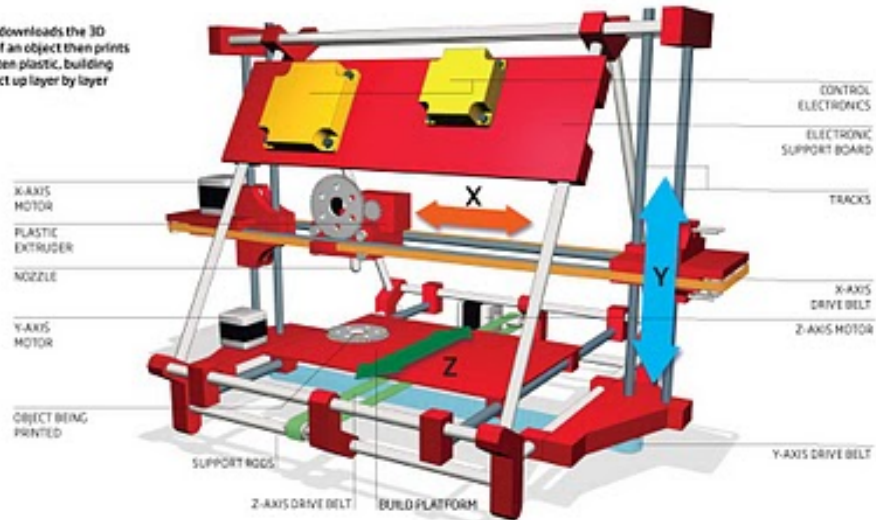

The New Scientist is running a feature article by Tom Simonite on RepRap and its derivatives this week. Tom visited the RepRap Lab at Bath University, the London Hackspace and other places a few weeks ago to research his article.

To read it, [go to this link](#).

Inkjet RepRap

Thursday, 10th June 2010 by Adrian Bowyer

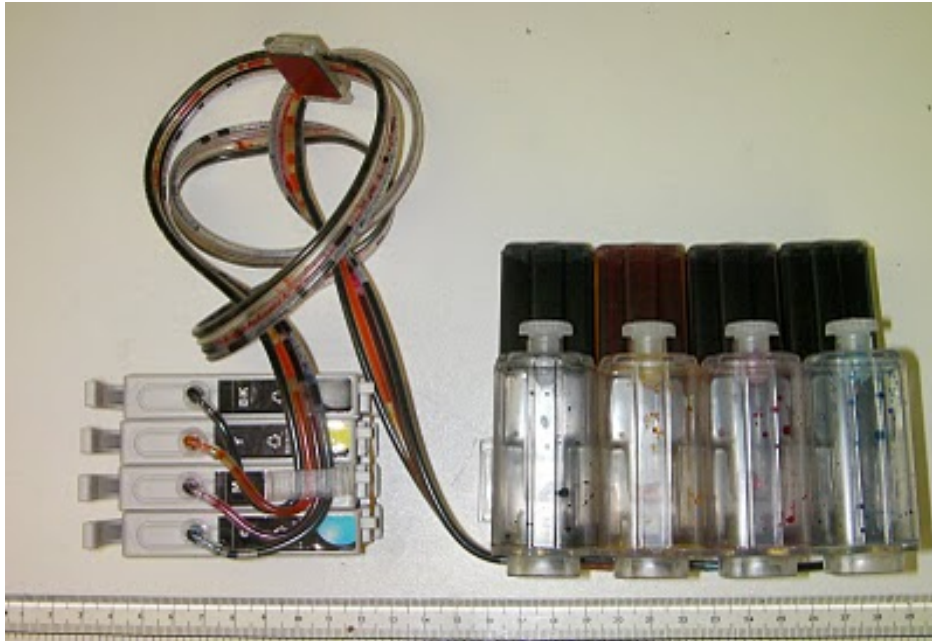

A while ago Amberish Jaipuria did some preliminary RepRap experiments with inkjets - [details are here](#). And before he left, Ed was always saying, "I think inkjet is the way to go."

It would certainly be nice to be able to lay down waxes, resins, conducting ink and all the rest in a RepRap with the fineness and precision that inkjet could give. We would probably want to use Epson inkjets, which use piezoelectric mechanical pulses to eject the ink drops. All the other systems boil the ink by resistive heating in a tiny chamber to eject it. The piezoelectric systems will obviously be more tolerant of funny polymers and the like, which might not take kindly to being boiled.

Recently I have been looking at continuous ink systems. These replace the normal (and horribly expensive) inkjet cartridges with a tank-fed system that holds 100 ml or more. And they're cheap - the four above cost me £13 in total including postage from [these people](#). You get the tanks, the feed tubes and the hacked recycled cartridges for that. I say hacked, because the cartridges are chipped to report emptiness to the printer - this is how the manufacturers try to prevent you doing re-fills. These report "full" all the time, I think.

Now, with an Epson, the piezoelectric heads are not in the cartridge (it's just an ink reservoir). They are built into the printer. There's a [good article about all this by Tim Hunkin here](#). (Note especially the bit about Epson heads clogging if you leave them unused or let airlocks get in.)

So to the \$64,000 question: I have done a good bit of searching for the electronic incantations that

need to be sent to the piezoelectric heads taken out of an old Epson printer, and I have drawn a blank. What's needed is the Epson equivalent of this excellent HP Inkjet book by Matt Gililand. I could prod about in the printer with a scope, of course, but it would be nice to have something authoritative.

Does anyone know what pulse-timing patterns and voltages Epson piezoelectric heads need?

Reprap Aggregation Pipe - V2 update

Wednesday, 16th June 2010 by Buzz



Hi All,

I just wanted to let you all know that the Reprap "Blog of Blogs" has just been upgraded to use the new Yahoo "V2" pipes technology! (today)

For those that live under a rock (or are new) this is the URL for the meta-blog of around 100 reprap blogs:

http://pipes.yahoo.com/davidbuzz/reprap_aggregation_pipe

..and this is a brief from Yahoo on the new technology, which went into BETA about a week ago.

<http://blog.pipes.yahoo.net/2010/06/09/yahoo-pipes-v2-engine/>

Happy Blogging!

Buzz.

Yet another extruder nozzle...

Sunday, 20th June 2010 by Adrian Bowyer

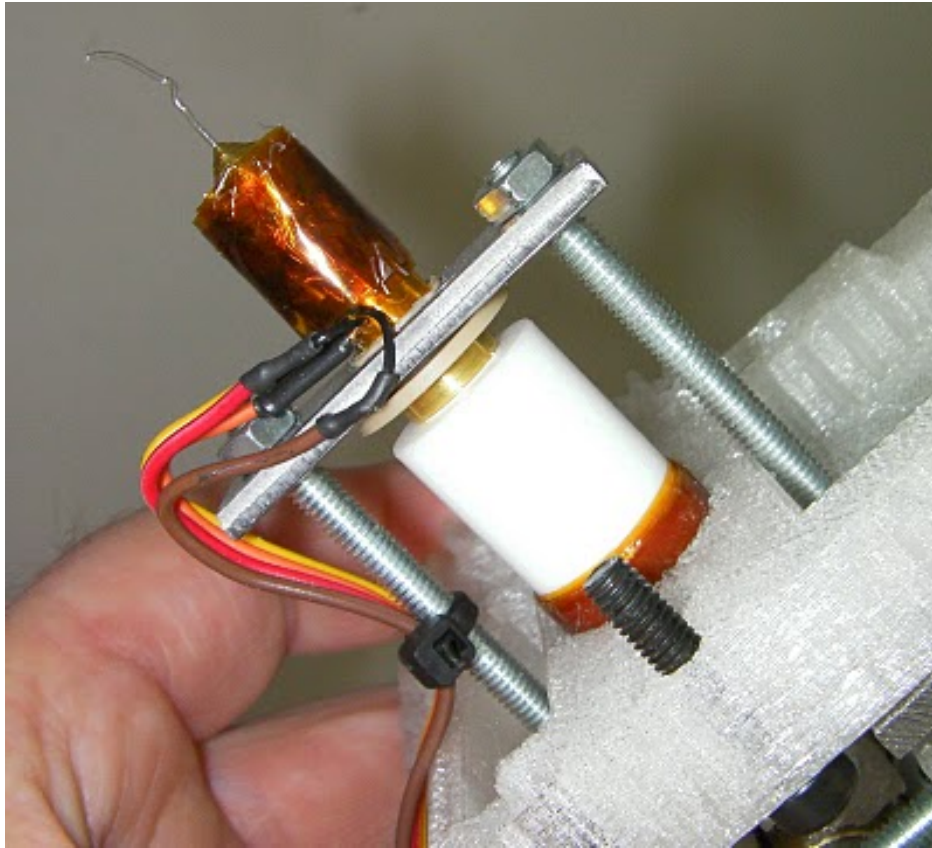

The shortcomings of the standard RepRap extruder have been moaned about (with some justification) on the forums and elsewhere. The PTFE barrel is in tension with the full force of the driven filament. It expands when hot, altering the Z=0 point, and it has the brass extruder nozzle screwed into it; this can tend to come undone, plus the working pressure tends to force the extruded polymer down the thread making and enlarging a gap between the brass and the PTFE.

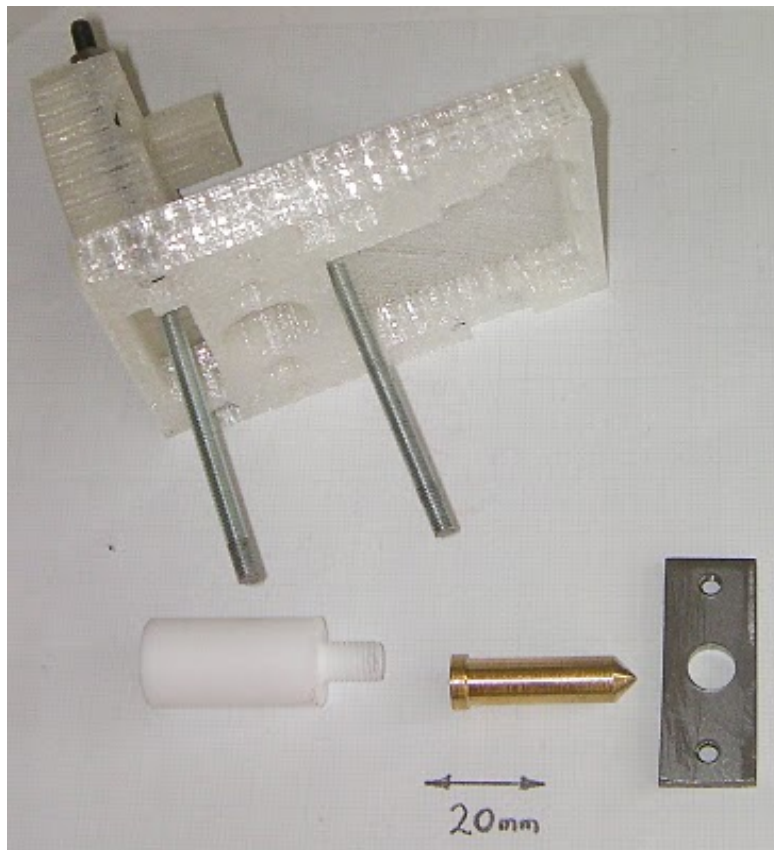

I have just designed a new one that attempts to combine the benefits of the original design, the very robust Bits from Bytes design, and a number of Nophead's ideas.

There is still a brass barrel and a PTFE insulator. But the PTFE screws inside the brass, so the internal pressure tends to seal the join, rather than opening it up. In addition, all the force is taken by a plate and two pieces of M4 threaded rod, rather than the PTFE. This means that the device keeps its Z=0 point. Not counting M4 nuts, it has six parts (there's a PEEK top-hat separator between the plate and the brass - you can see that in the top picture, but not in the exploded view).

Final advantages are that it's much easier to take apart and to put back together, and you don't have to wait for glue to set before using it.

All details will be [here on the wiki soon](#).

Vectorization of pixel defined print roads

Monday, 21st June 2010 by Forrest Higgs

In which your narrator describes the end, hopefully, of a search for a reasonable way of converting pixel-defined print roads calculated by Slice and Dice.

For the past two months I've struggled with what has been, for me, a very nasty problem, viz, converting pixel boundaries defining print roads for my Rapman printer into equivalent vector descriptions. As I mentioned previously, in order to get a major axis velocity of 16 mm/sec on the SD card Rapman 3.x you have to have GCode vectors of no less than 0.3 mm. If you are printing detail finer than that the lag caused by reading off the card and processing the GCode slows down the print head dramatically.

From my literature search, vectorization is a fraught process, especially if you are not willing to accept considerable degradation of your pixel-defined road. With 3D printing, perforce, we really can't accept degradation.

Over the last few weeks, I've finally concocted a method which seems to do the job. As with most things I do, it is relatively simple and straightforward.

Suppose we have a perimeter path for an involute profile gear...

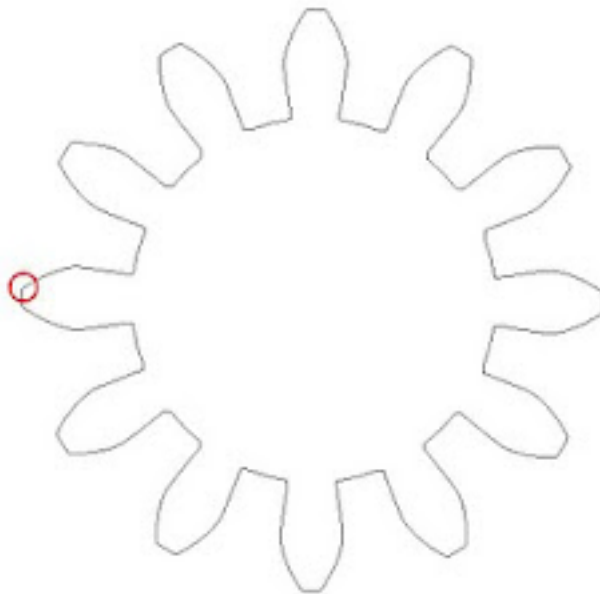

The method grabs a 2.1 mm patch {note the red circle} at the extreme left of the path which you can see here...

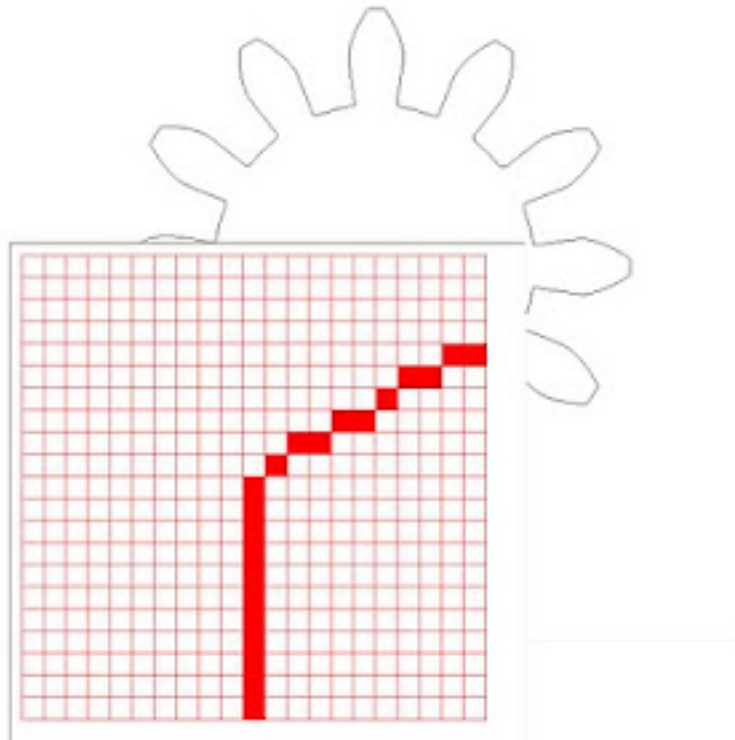

Here you can see the individual pixels making up the print road. The first thing we do is define the starting point and direction of the road from the centre of the patch.

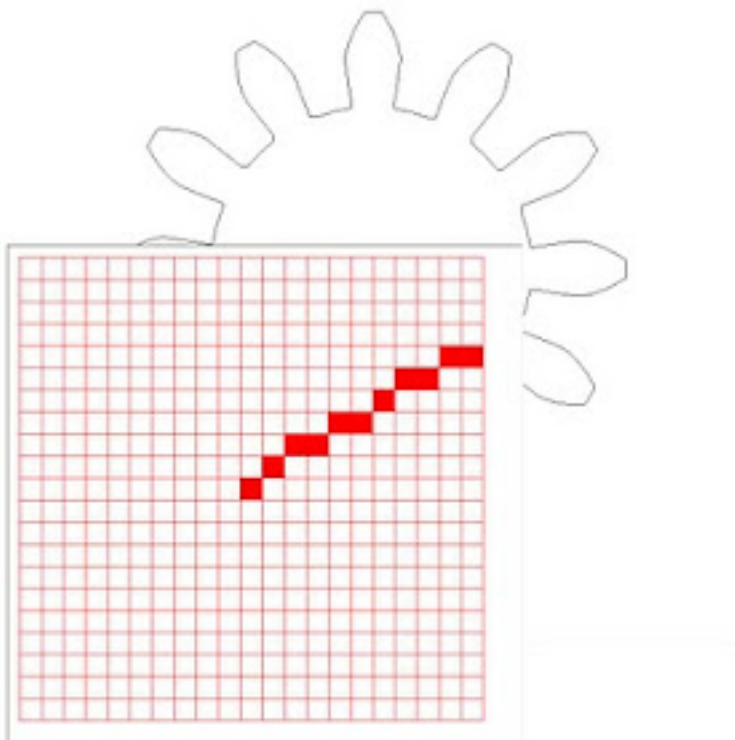

At that point I pivot a scan from the center of the patch and identify the closest fits at ranges varying from 1 pixel to 11 pixels.

In this case, the longest perfect fit to the involute profile was 4 pixels.

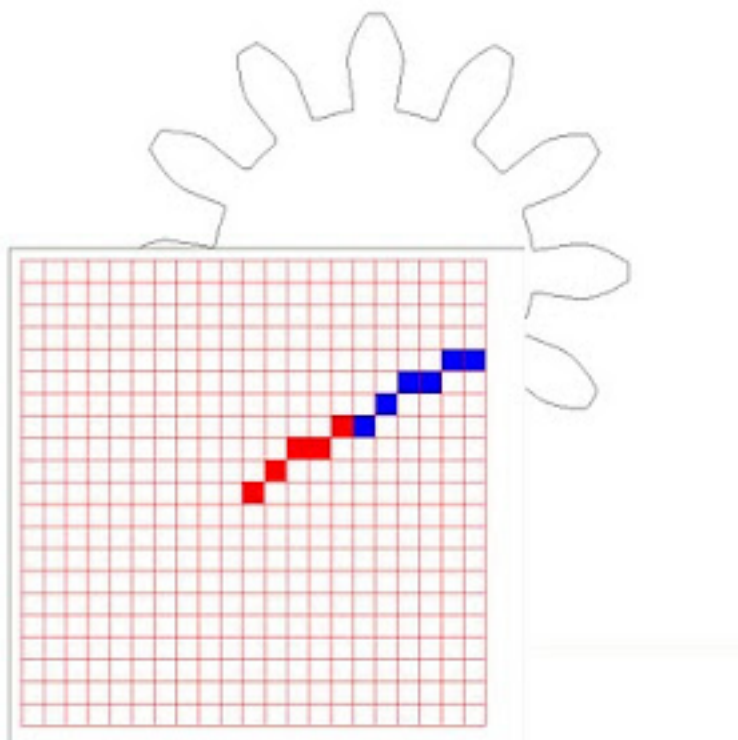

Red pixels represent the fitted vector while blue indicate the remaining pixels. Notice that this vector is four pixels long, just enough for the Rapman to operate at 16 mm/sec. The patch is then re-centred over the most distant red pixel and the process repeated until the full loop is vectorized.

Looking at a simpler problem, consider a hexagonal print road...

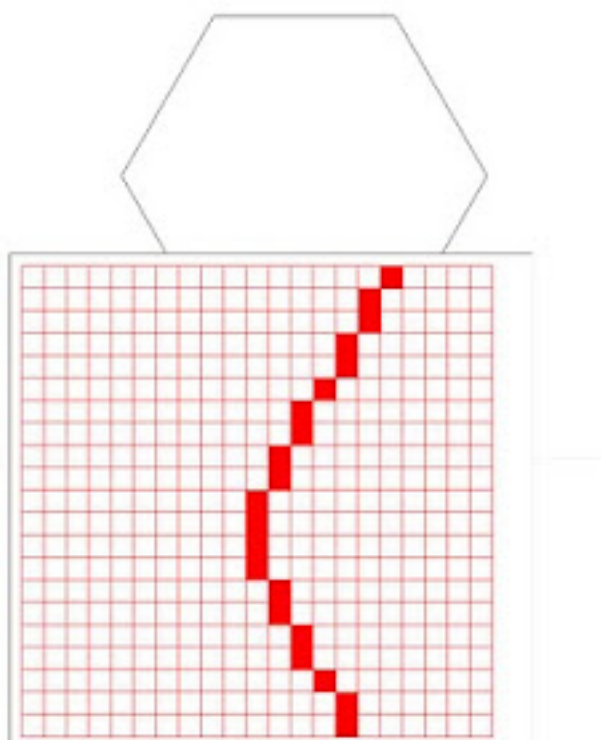

Isolating the beginning of the print road yields...

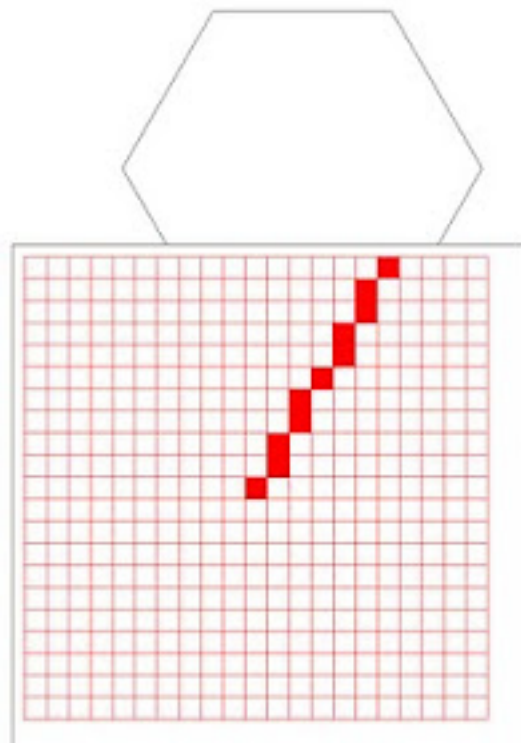

Scanning this straight line gets a perfect match at 11 pixels. Thus the way I have the code set up now creates vectors of up to 11 pixels in length, a maximum length of about 1.4 mm. It's reasonable to ask why the vectors are kept so short. In fact, it takes much longer to process the print roads with longer vectors and there is no reason, SD cards having huge storage capacity, not to have large print files.

As I get time in the coming weeks I will be fully embedding this method into Slice and Dice.

New Release

Monday, 28th June 2010 by Adrian Bowyer

I've just done a [new RepRap release at Sourceforge](#). This will probably be superseded quite quickly (we are in the process of standardising the M Codes used to drive the machine, which won't take long).

The host software now runs an awful lot faster when it is slicing RFO files and STL files. This is because I removed something that, in my ignorance, I had thought would make it run faster, but which experimentation has now shown had the opposite effect: I had put **afinalize()** function in all the geometry classes. That seemed reasonable - give the garbage collector a bit of a hand to tidy things up. But what it actually does is to subvert the garbage collector and to put unreferenced memory into a queue for later removal; a queue that rarely - if ever - seems to get acted upon. If someone can explain why this is a good idea, I'd love to hear it.

Meanwhile, all the **finalize()** functions are gone, and the host software now runs pretty zippily... (It uses a lot less memory, too.)

The algorithm it uses to find outlines of slices has also been changed to Marching Squares, which seems both more reliable and faster.

The new software now also supports heated beds.

Vectorization of pixel defined print roads actually working properly

Tuesday, 6th July 2010 by Forrest Higgs

In which a very kind Adrian Bowyer takes pity on your narrator.

In my last posting on 21 June, I laid out a method for vectorizing a pixel-defined perimeter. Having read the posting, Adrian Bowyer, a published expert on this sort of thing, took me aside and showed me how to do the vectorization efficiently instead of just at all, the solution I came up with.

Using Adrian's approach, I was able to achieve my goal of getting exact vectorization of the print road and push out the average segment length to well over the 0.3+ mm that was required to assure a print head speed over the major axis of at least 16 mm/sec.

You can see an example of such a vectorization here. All values, save the last, are in tenths of a millimeter.

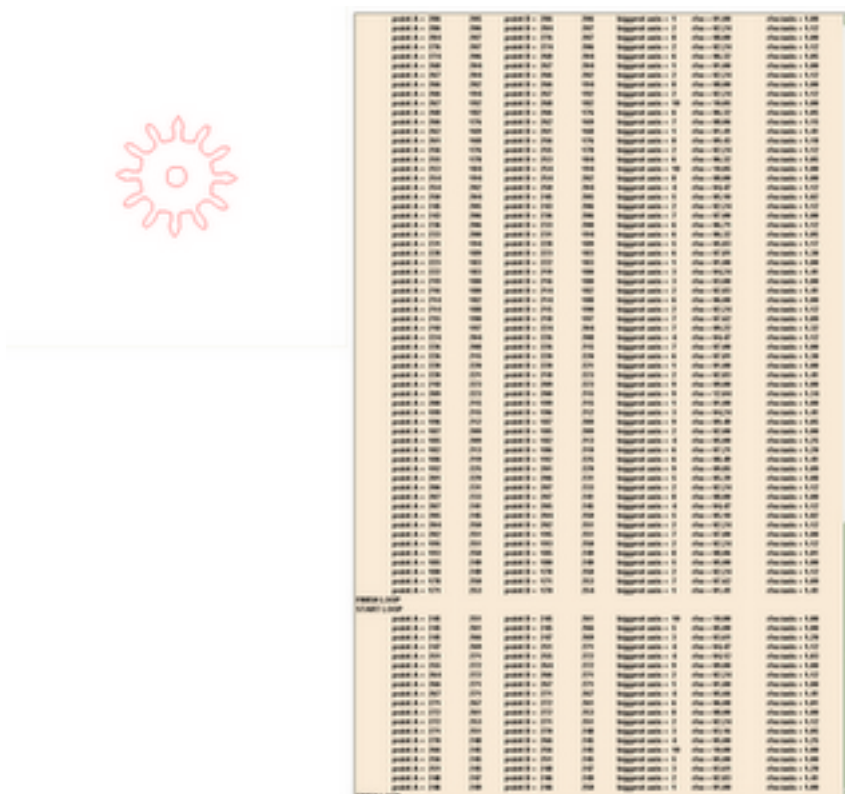

The image shows a screenshot of a software interface. On the left side, there is a red gear icon. To the right of the gear is a large listbox containing many rows of numerical data. The data appears to be organized in columns, with the last column containing values that are likely the 'rho/axis' values mentioned in the text. The listbox is filled with numbers, and the last value in the list is highlighted.

The last value in the listbox, "rho/axis" should allow me to adjust the print speed on the fly in G1 statements to assure a constant head velocity for print road segments greater than 0.3 mm in length.

I should be printing ABS parts again by this weekend, which is good since I want to redesign and print one of these.

Overhang support and PCBs

Thursday, 8th July 2010 by Adrian Bowyer

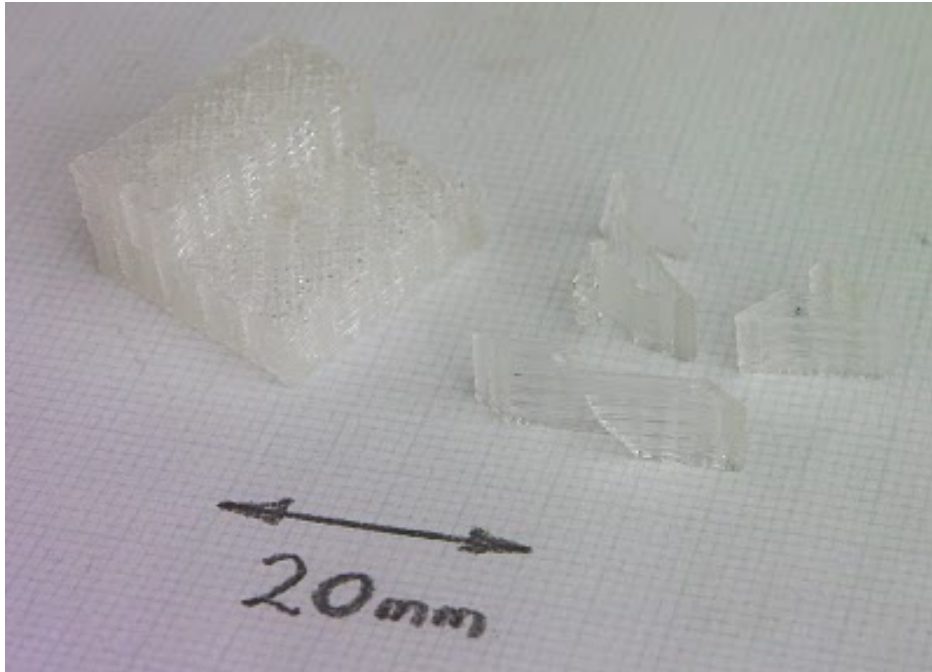

With a lot of work going on on putting pen-plotters in RepRaps for PCBs (and other things), it seemed to me that we might re-visit an old idea.

That idea was using oil to assist separation of support material. Now that the Java host software does full overhang support calculations, it seemed that we might combine the two: a pen plotter with an oil-filled felt pen would run over the top layer of the support after it had been laid down to make it easier to break away when the part was finished.

Above is a brief experiment I did by hand. The L shape was built 'the wrong way up' forcing it to need support. Both the part and it's support were PLA. I paused the build at the last layer of the support deposition, and wiped corn oil over the support with a Q-tip. Then I resumed the build. The support material did indeed separate much more easily than it does without the oil.

If a support layer was simply plotted twice when it was the last support layer under the part, once with the polymer, and then once with an oil-filled felt tip, this would give the same ease of separation. The same pen plotter could be used with an etch-resist pen to make PCBs, such as these designed to make reprogrammable electronics simple. Two birds; one stone.

RepRap in the Year 3000

Friday, 16th July 2010 by Adrian Bowyer

RepRap has started to appear in primary school writing and composition exercises.

Here is the homework of Alpha Perry, aged nine. She was asked to imagine herself as a news reporter in the Year 3000, and to write a piece on the history of a technology.

I thought that this was so good (despite its containing bits from me) that I asked her and her parents for permission to add it to the RepRap site...

Mendel & multiple materials

Saturday, 17th July 2010 by Rhys Jones

It has always been the intention to fit a head changer to Mendel, I've had a go myself on several occasions but always ran into the same problem i.e. I haven't been able to do so without substantial modifications to the core frame of the machine unless there is a substantial loss of build volume (...I once had a design that ended up having a maximum build height of 2cm.very practical:D). Moreover, it's more difficult to have a head changer for extruders whose designs are still in the early stages (such as the paste extruder). The main problem I suffered with is that regular designs of extruders are just too bulky without increasing the overall size of the machine, which incidentally I think is the perfect size as it is. Any bigger, and I would find it too big to find houseroom for!

Thankfully, eD had the idea of bowden extruders some time ago, which quite a few people seem have gotten work. Thus I think way forward for the time being is to implement a carriage for multiple bowden style extruders. Although this is almost certainly going to reduce build quality slightly. Some have already designed multiple bowden extruder carriages; here is my take on it:

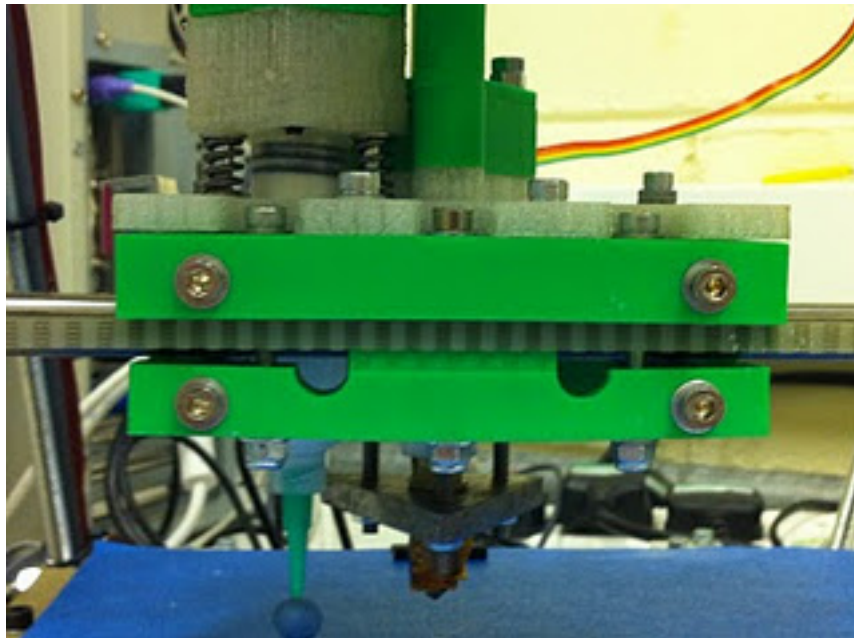

The main differences are:

1.Support for three extruders, either bowden or paste. (limited syringe size of 10cc).

2.All the multiple head machines I've seen rely on the extruders being exactly the same height in order to get the bed clearance just right to produce good builds. I've always found getting adjusting bed clearance is tricky enough just for one extruder, and I think it's likely that there will always be a build up of tolerances that extruder heights will always change by significant magnitudes. Even still, with warping and so on in the carriage, it may still be difficult even if the extruders were identical. Thus, the carriage treats each extruder clearance like pretty much everything else on Mendel, by allowing for adjustment. All extruders are attached to a mounting plate, of which on the underside are of series three captive nuts for each extruder arranged in an equilateral triangle. Three compression springs are then placed between the plate and the extruders, and cap screws are used to adjust the compression of each spring independently. (In the picture above I've only used the springs on the left hand extruder, it makes sense to fix the main extruder and adjust the other two to match it)

3.In the same style as the mini carriage, the bearings are all located within the carriage itself. Having the bearings located on the outside surfaces of the carriage(like the standard Mendel design) ensures that the walls of the carriage must lie between the bearings and any extruders, eating into the working volume. However this does result in quite a wide carriage.

4.I needed to make some compromises, neither of which I'm particularly happy with, so that I don't have to redesign the whole x-axis. Firstly the belt travels through the carriage itself on the 360 side, and secondly the belt is clamped from the inside out.

5.Finally its NOT makerbotable (its about 115 x 95mm), but it should be a fairly easy redesign to allow for only two extruders. . Even still, if you have a RepRap I'd recommend printing in PLA or using a heated bed or you'll probably run into trouble

Anyway, I've heavily modified the [Paste Extruder](#), and used it in parallel with a bowden extruder I designed that based on [Erik's design](#)but using a worm gear to do the driving (Designs to be on the SVN/thingiverse shortly). Gerrit Wyen (an intern at the RepRap Lab @ Bath Uni) created a simple script to take account of the offsets between the extruders and modify the GCode accordingly. Also Adrian has done so much I've forgotten exactly what he's done, but its a lot:D. Here is a video one of the first prints; it's a cube using PLA for the outline and top and bottom layers, and silicone sealant for the interior infill:

Whilst I did reverse the extruder to prevent ooze, and this is sufficient during a "normal build", its sat there for such a long time doing nothing whilst the paste extruder is working it still oozes horribly. For this reason I built little barrier to collect the ooze from hitting the part, but I think we may need to lower the extruder temperature a little when not in use. Anyway, here is the final part, which came out surprisingly well:



There are some more photos of the test setup and some other less successful prints [here](#).

Glow-in-the-dark PLA

Friday, 23rd July 2010 by Vik Olliver

I've just had the first sample run of glow-in-the-dark PLA back from the factory. I didn't change the extruder parameters at all from using ordinary PLA and it seems to extrude absolutely fine as far as I can tell. So, here is (as far as I know) the first intrinsically glow-in-the-dark Mighty RepRap Power Ring :



The phosphor pigment (no actual phosphorous used) needs to be mixed into the plastic at about 10% loading, which is an order of magnitude more than is normally used for colouring. Getting powder to evenly coat the granules at that density is hard, but Alan Booth at Imagin knows a trick or two and it came out beautifully even. The only problem is the cost, which by the time I've got 100m of 3mm filament in a bag is about NZ\$60. That's using the cheaper phosphor too - not because I'm cheapskate but because the really good stuff isn't available in quantities of less than a tonne!

Memories of plastic model airplanes

Monday, 26th July 2010 by Forrest Higgs

In which your narrator harks back to his youth and fingerprints ruined by trimming plastic flash off of model airplane parts with double edged razor blades.

I have an aversion to infills. Recently, I realised where the aversion came from. During the 1950s you could buy plastic model airplane kits for \$1-2. These were made with injection moulded parts that came on little flat plastic Christmas trees. Exacto knives in that era were both expensive, for a child at least, and the blades dulled quickly and were largely beyond the ability of a child to resharpen. As a result, this child nicked paper-thin double edged razors from the medicine cabinet to trim the parts off of the tree and trim the flash off of the parts.

That worked fine, except for the cuts which the blades would make on ones fingertips which eventually grew into permanent scars. That was no big deal in those days.

Having trimmed your parts you glued them together with Testors or Duco cement {ethyl or butyl acetate} and, with a bit of paint, you had a lovely airplane to hang off of your ceiling by a thread and dream about flying.

Early on in the Reprap project, we used Solarbotics gearmotors. When you opened one of the gear boxes of, say, a GM-3 you found that the housing had been made using the same injection moulding process that model airplane manufacturers used. With a working Reprap printer I quickly began to loathe the clumsy, infilled parts that we were designing. They wasted both time {to print} and filament as well. Worse still, one tended to stick the parts together with expensive nuts and bolts.

Why not make parts that fit together like the old model airplanes?

The trick there is that the old model airplanes inevitably had a left side and a right side or a top a bottom that were often simply mirror images of each other. This weekend I was design a finger tip with left and right sides. I had designed the left side and got it working acceptably and was going back to do the right side in Art of Illusion {Aoi} when it occurred to me that it would be much simpler to just write a script to swap the sign of the coordinates of the axis that I wanted to mirror around. Writing that script took about five minutes and saved me a lot of time in redesign and reprocessing of the resultant STL since my script operated directly on the Gcode.

Printing the two halves was trivial.

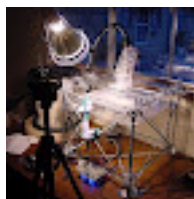

It took a few moments to scrape off the raft and a few drops of cement to finish the part.

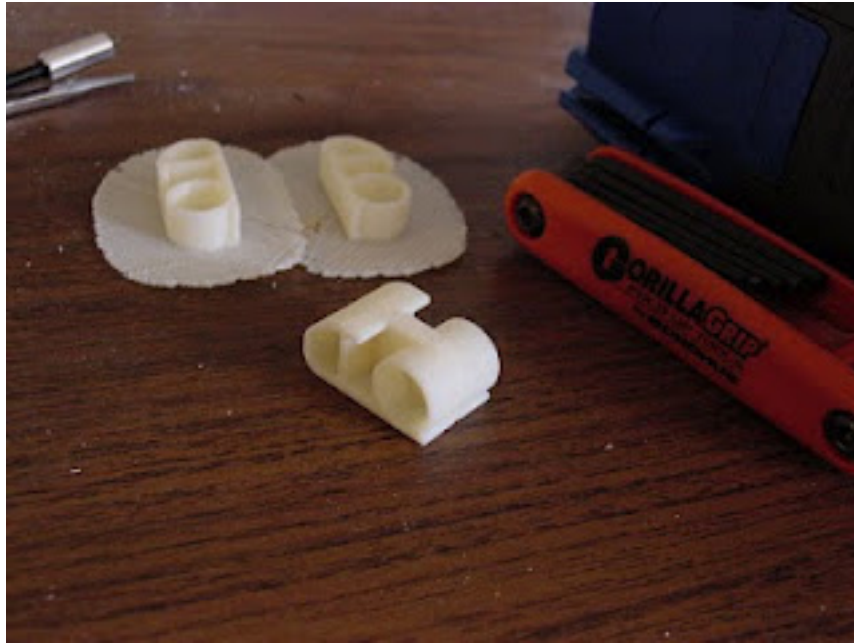

The result was an elegant looking part that would have been a right bastard to design and print conventionally.

While I've incorporated this simple mirroring script into my own Slice and Dice STL processing software it would be no big deal to incorporate it into the more widely used STL processing routines available to Reprappers either open source or commercial.

Some thoughts and observations about having a Reprap machine in the design cycle

Wednesday, 28th July 2010 by Forrest Higgs

In which your narrator reflects on the rather radical difference between what he perceived the design process would be pre and post the advent of practical Reprap printers.

From 2005 till November of last year, I spent most of my free time trying to build a Reprap printer. It was good fun and I learned a lot of things. Mostly, I learned how not to be intimidated by technology that I was not familiar with. For me, this was an extremely valuable lesson.

When my day job began to require more and more of my attention towards the middle of last year, my development of Tommelise 2.0, my own repstrap project began to suffer. Finally, at the end of October I sat down and did an unpleasant assessment of my situation. I could continue to work on Tommelise, or I could simply buy one of the Reprap-derived kits that were beginning to emerge from small enterprises started up by other core team members. I estimated that it would take something like another 6-8 months to get Tommelise 2.0 printing properly. I subsequently ordered one of Ian Adkins' Rapman 3 printers.

Rapman 3 is a re-engineered clone of the first generation Darwin design. I bought it rather than the somewhat cheaper Makerbot primarily because it had a substantial print volume but also because an associate, Batist Leman, had been blogging his experience with the model. Batist was very impressed with the Rapman and communicated that very well through his video clips of it in operation.

Prior to November, I was designing and making parts with the object of making a Reprap machine. Afterwards, I was designing and making parts WITH a Reprap machine. The distinction can be easily lost on those who have not used a Reprap machine.

What I have discovered in the eight months since is that the availability of a Reprap machine makes a massive change in one's design practices.

Prior to November I lusted after a professional 3D CAD package. Features like dimensioning and reliable boolean operations cluttered my thinking. The problem was that I was thinking like an engineer, viz, I wanted to make careful designs in 3D and then have print them out on an accurate 3D printer. I no longer feel that way.

With the advent of Art of Illusion (AoI) 2.8.1, I stopped lusting after "professional" CAD packages even though by that time I already owned several. My design cycle now looks like this.

- (re)design (a) part(s)
- print the part(s)
- manually and visually see how the parts work together
- repeat the process until satisfied

Precise dimensions became not very important while things fitting together properly did. The linkage between these two factors was not as strong as one might first suppose.

With a Reprap printer it became a simple matter to run through a dozen design cycles to get a parts ensemble to work in a matter that suited me. I currently design with the Reprap printer as part of the design cycle rather than using it as a final step after design cycles are finished.

At the beginning of this year Skeinforge, which I had been using previously, went through a rough spot. This encouraged me to invest in the upcoming Netfabb software prior to its release. As the Skeinforge rough patch continued and the folks at Netfabb's release dates began to slip, I finally became frustrated and then angry. I wasn't able to do the design work I wanted.

In frustration, I unearthed my old Slice and Dice code from the Tommelise project and began to bring it up to date. Having used both Skeinforge and the nascent Netfabb offering to process STL files into print instructions I evolved a very different approach to processing solids files than what either of these two products offered.

Both Skeinforge and Netfabb basically take your STL and give you print instructions. They do it very quickly and efficiently. Unfortunately, if you have a dodgy design file they can produce some very crazy print files. One's ability to respond to crazy print files is, perforce, limited. With both Skeinforge and Netfabb, the majority of craziness is generated when one's STL files are flawed.

The need for perfect STL files had fueled my previous lusting after "professional" 3D CAD packages.

I responded with Slice and Dice by internalising Mandelbrot's maxim that ***noise is always going to be there and it will be unpredictable***. Instead of striving for perfection, Slice and Dice concentrated on giving me options to deal with imperfect design files. I began by keeping each slice of a design file as an image that I could bring into simple image handling tools like Windows Paint and manipulate. Paint let me patch and alter flawed slices to suit myself. I no longer needed a "professional" 3D CAD system. Aol was just fine for my purposes.

From there, I discovered that if you use 2-3 print roads to define a print's perimeter you wind up with a strong part even without infill. I began working to improve my control of perimeter print roads and soon found that I could make parts not unlike those in old fashioned plastic model airplane kits which used injection-moulded parts that you glued together. Infill became unnecessary in all but the most extreme cases. Hollow parts were tremendously quicker to print and not nearly so prone to warping, as "solid" parts. I don't use a heated bed and doubt that I will anytime soon.

Conventional Reprap thinking views a 3D printer as being able to print, more or less, any 3D object. Development has concentrated on infill and support materials to achieve these ends. Both are wasteful of printer time and materials, in my opinion. I try to design parts which keep in mind the strength and weaknesses of my printer.



As you can see with this telepresence 'bot finger, I think I am getting pretty good results.

Continuous belt production

Thursday, 29th July 2010 by Adrian Bowyer

As opposed to continuous-belt production...

I think that (as with so many things) the original idea for this came from Ed Sells. And lots of people have subsequently had ideas of rewrapping on a continuous conveyor belt running over a flat surface. See [here](#) and [here](#) and [here](#).

The big advantage would be that you could print for as long as the plastic filament lasted, continually throwing rewrapped parts off the end into a bucket. They would be split from the belt as it ran over the winding roller.

There are two problems that have to be overcome:

1. Keeping the belt flat against the tendency of parts to curl away from it, and
2. Driving it accurately without slip.

The first problem is significant; as Nophead pointed out [in the forum discussion](#), you need a tension of 100 kN to keep the belt flat to 0.1mm. Vacuum doesn't help, as it would create too much friction preventing the belt from moving.

But the second problem is quite easy to solve (usual apologies if someone has thought of this before) - you do continuous production without a continuous belt:

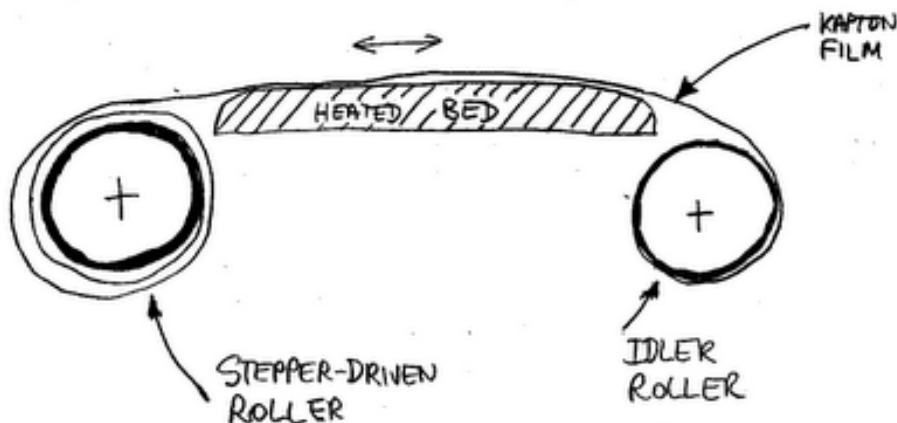

By winding and unwinding between two rollers you can cover the entire length of the bed, and pull the part off by running it over the end roller. You can then rewind to print the next part. A simple flag on the belt passing through an opto-switch would allow the system to be zeroed.

Driving the idler roller might require some thought. As the belt winds and unwinds, the roller diameters change, and so does the required velocity ratio between them. The stepper can

compensate for this effect by changing the number of steps-per-millimeter it uses depending where it is on the belt to get the build right. But the idler has to do the inverse.

The first thing to say is that - with a thin Kapton film belt - this probably wouldn't matter and you could just run the two rollers with a timing belt between them relying on the elasticity of the system to take up the slack.

But if it did become a problem there are at least three solutions:

1. Drive both rollers with steppers. I don't like this as they're bound to end up fighting each other.
2. Put a wind-up spring on the idler roller to take up the slack. I'm not too fond of this either. It would probably load the stepper too much, and the forces required from the spring to achieve sudden movements would change with the mass of the object being rewrapped.
3. Keep a tension on the film by driving the idler clockwise (in the diagram) with a DC motor on a controlled constant current source. Constant current should give constant torque. By changing the current you could compensate for increased mass needing to be moved.

But there's still the problem of keeping it flat...

Towards reprogrammable electronics

Saturday, 31st July 2010 by Adrian Bowyer

RepRap Mendel with Pololu Electronics from Adrian Bowyer on Vimeo.

A while ago I designed an alternative set of RepRap electronics with the intention that the PCBs required for it would be particularly simple, and hence potentially reprogrammable. This is the prototype (which I made on stripboard - also easy) working. It's all described here on the wiki, along with a number of other people's versions.

The steppers are being micro-stepped (1/16). This makes the whole thing virtually silent, and very smooth in its movement. The firmware supports this new configuration.

We're Going to the Faire!

Saturday, 31st July 2010 by Sebastien Bailard



Image not found.

Dear readers, the developers of the Michigan RepRap User Group cordially invite one and all to the Detroit Maker Faire !

(Have fun guys!)

Applying VTEC to Slice and Dice

Wednesday, 4th August 2010 by Forrest Higgs

In which your narrator lowers the execution time of Slice and Dice by upwards 90%.

Now that I am well into designing the hand for my telepresence project, I am running into the limits on the processing speed of Slice and Dice in the design cycle. In the past, I could run the code through a good wash and brush up and reduce the execution time by 90%. That would take about a man-week that I don't want to spend. Instead, I chose to take advantage of a characteristic of the parts I design to achieve faster execution speeds.

Typically, I have been designing parts that look somewhat like this.

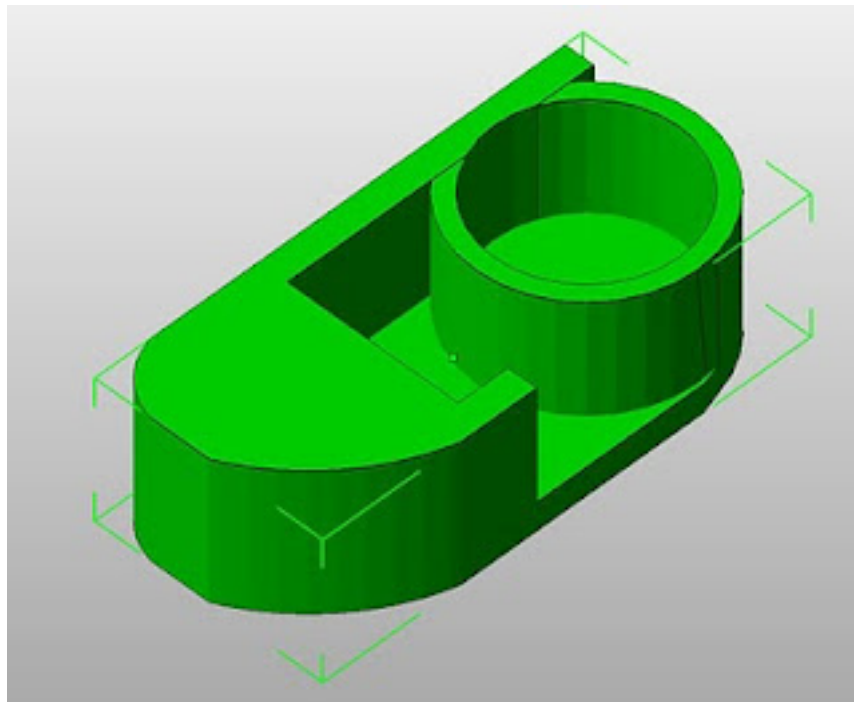

When you look at it closely, you notice that there are really only two different cross sections through the vertical axis.

Now Slice and Dice as I wrote it is not particularly bright code. I wrote it to be simple, not efficient. When you slice this object into 0.25 mm wafers you get 39 slices that look something like this.



Slice and Dice tediously processes each slice as if it were unique. I took a day off to see if I could take advantage of the geometric repetitiveness of my parts. To do that I initially thought to simply match each image with succeeding image and throw out the duplicates.

Life wasn't quite that simple. While the slices looked identical, miniscule differences in the way the slicing routine interacted with triangles showed up in the flooded pictures seen above. I did find, however, that if I allowed flaws in the pixels of up to 0.2% of the total in the flooded images the 39 images were reduced to exactly 2...

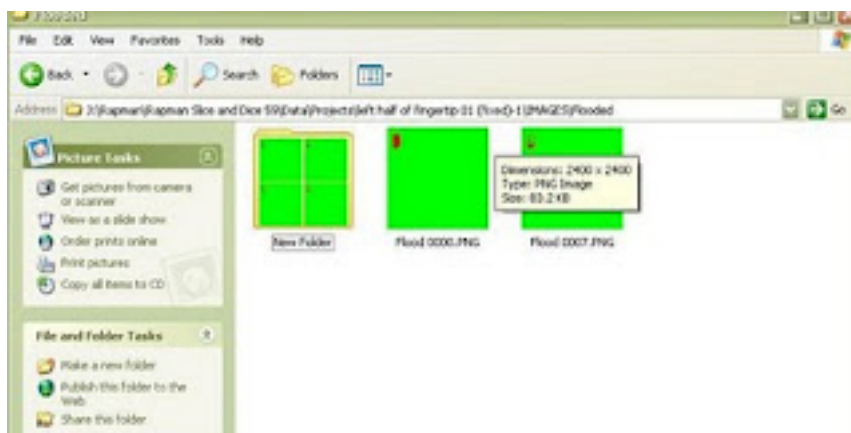

Which is what you would have expected if the slicing had been geometrically perfect. Thus I had to do cpu intensive processing on two slices instead of 39. That saved about 94% of the

processing time that I had previously been using and got my processing speed into the range I was used to seeing with Skeinforge.

As an added advantage, the reduction routine picks up broken slices very nicely.

This approach would not, I think, work with a programme like Skeinforge or, unless I misunderstand how it works, Netfabb. It could, however, easily be applied to Adrian's host code for Reprap.

Reprapping two materials into one object

Thursday, 5th August 2010 by Rhys Jones

A couple of days ago, we needed another set of tweezers for the RepRap lab. Naturally, rather than going and buying a pair I thought I'd RepRap them. After a quick search around Thingiverse for inspiration, I thought we could do something a bit more fancy using the new multiple material setup. So I designed the following pair, where the top of the tweezers consists of a PLA inner section for rigidity/stiffness, which is then encased in silicone for added grip, and printed in one shot:

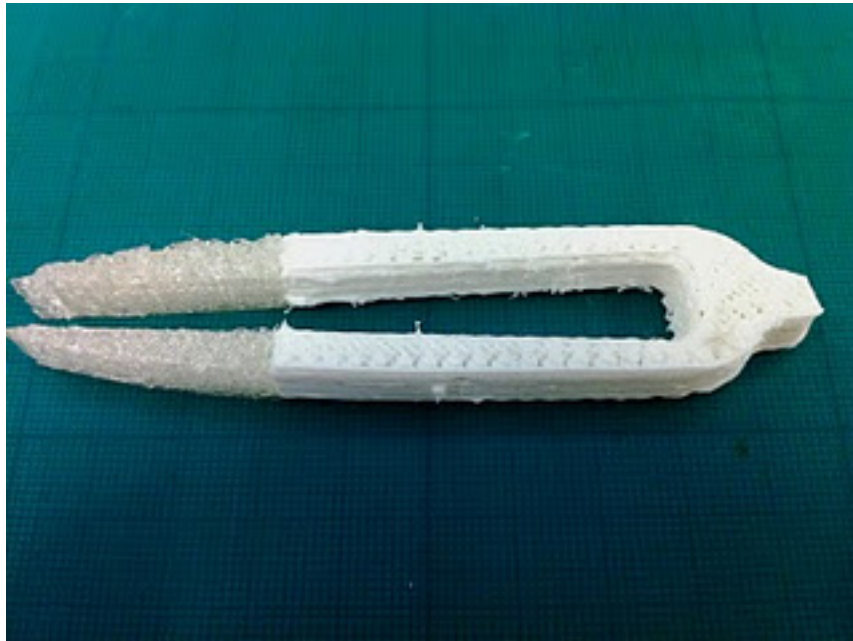

Unfortunately, the nozzle of the paste extruder blocked mid build. Thankfully, they are disposable so I quickly swapped it for a new one (I noticed as I set the paste extruder to purge on every layer...). I suspect what is happening is the orifice of the plastic taper tip is deforming as it runs over the occasional PLA lump in the plastic sections of the part.

The three STL's which make up the part are up on Thingiverse and on our wiki, although you'll need to assemble them in the host software using the technique described here.

Improving print roads calculations

Saturday, 7th August 2010 by Forrest Higgs

In which your narrator rewrites the Slice and Dice routine that calculates print roads on a slice.

Having got a working finger design for my telepresence hand project, last weekend I set about to rig it to a servo motor to see what issues would come up. One of the items needed was a reel which screws onto the servo which takes up the tendons on the finger and moves them in concert. The 40 mm reel looks like this...

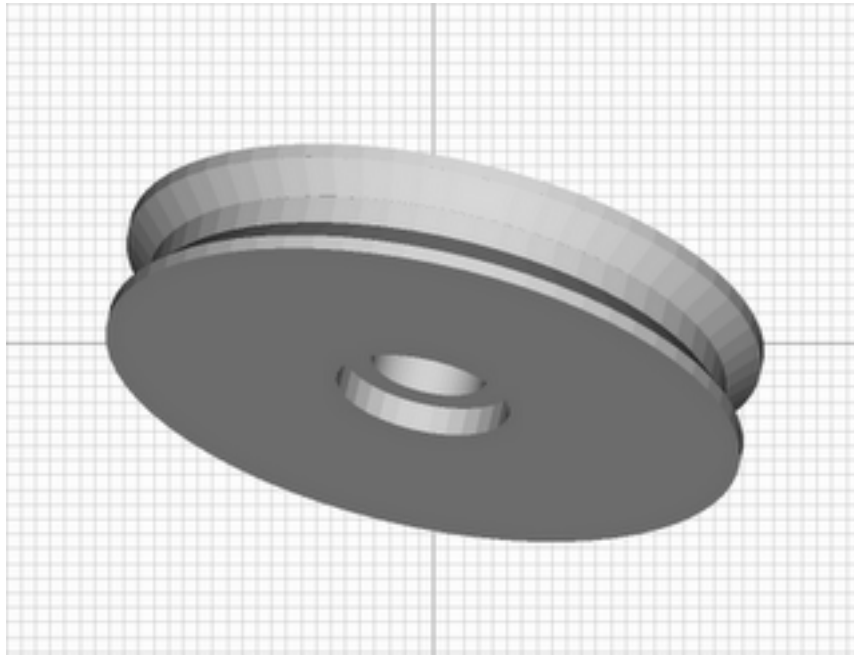

I wanted to make the reel solid since it will be under considerable torque. To achieve that I used my concentric print roads option rather than cross hatching. I am not fond of cross-hatching mostly because the join between the perimeter of a print and the cross-hatching is so often mechanically poor. Using concentric print roads yields a much stronger print.

I calculated concentric roads very simply by painting a strip of pixels on the boundary of the slice to create an interior print road, deleting the strip to define the print road and then painting another strip inside of the new, smaller boundary. I repeated that simple process until I ran out of slice. Heretofore, I'd used concentric prints for relatively shallow prints like this phalange...



This looks pretty good. I had been quite happy with the concentric roads routine till I applied it to the spool. The spool was a deep object, 40 mm in diameter with an interior and exterior boundary. You can see what happened...



The roads track the original boundary quite nicely till you get 6-8 roads away from the boundary. Then, geometric features of the original boundary are sufficiently magnified that the roads bear

little resemblance to the shape of original boundary. The reel provides a really nasty example of this kind of distortion.

The reel that resulted was actually very strong, but looked nasty. Last night, I undertook to see if there was another way to do the job.

After several false starts, I discovered that if I began with the original slice boundary in one picture box and then mapped a filled circle of the proper radius onto each pixel in the boundary I got extremely smooth print roads. The reel slice you were first shown looked like this with the new routine...

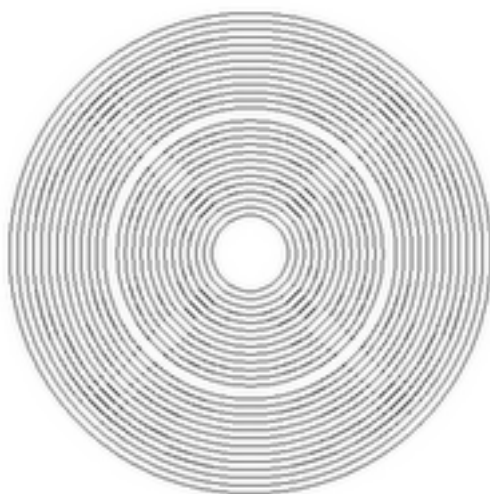

You will notice that the interior and exterior boundary roads match each other very well but show a gap between the interior and exterior roads. The hole in this slice of the reel is a screwdriver access port for securing the reel to the servo drive shaft. The dimension in this slice is just big enough to pass the screwdriver tip. I widened that access port by two millimeters and the problem with the roads mismatch disappears as you can see here...

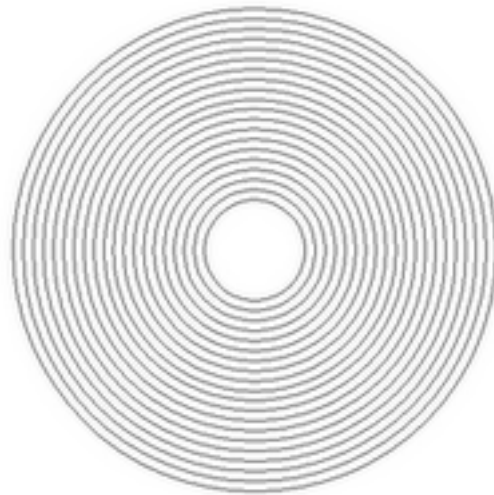

The reel consists of two parts; the reel itself and an insert which is glued into a recess in the reel which seats over the servo drive shaft and allows for a screw to secure it. You can see how this works in this exploded view of the ensemble...

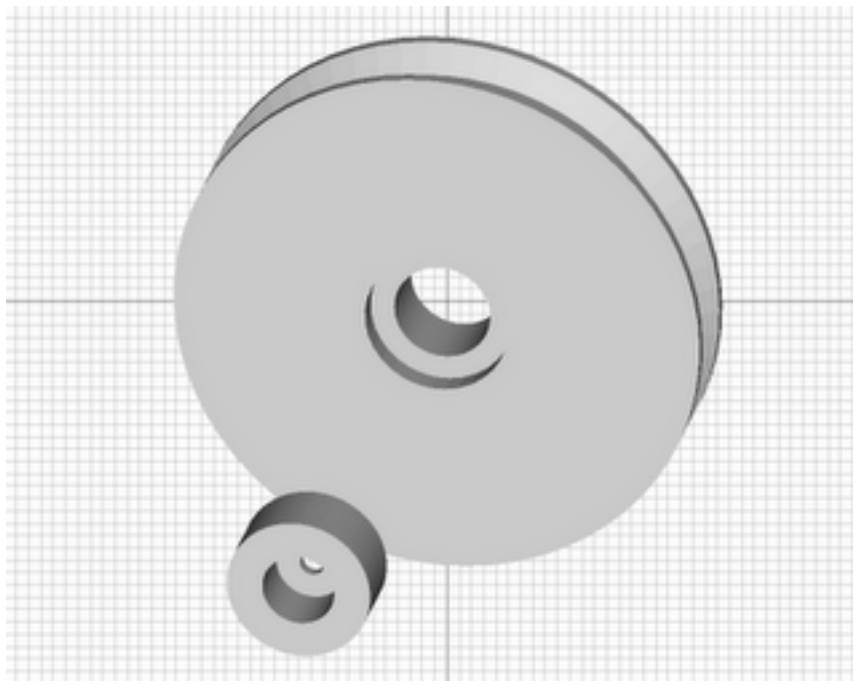

As designed the print road pattern for the reel slice defining the recess for the insert looks like this.

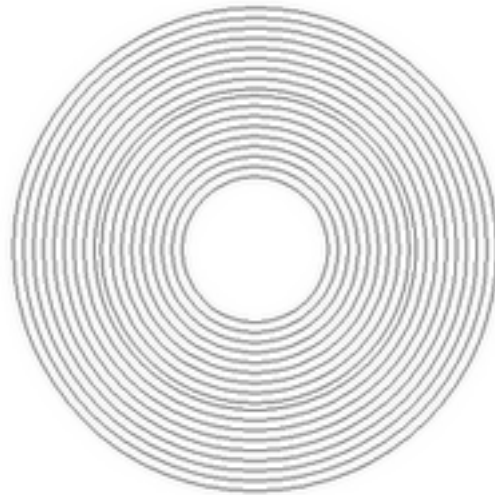

If you look closely you will notice that the meet between inner and outer roads is a bit tight. The outer dimension of the insert is not critical and can be adjusted a bit to even that out. Care must be taken, however, to not compromise the roads in the insert in the adjustment.

The more experience I get printing dimension critical parts the more I understand what a balancing act getting the proportions is. When you are printing a critical part you can't just slap it together in CAD, pump out an STL and print it. The print road cross section is an integral part of your design and you have to exercise considerable cunning in making everything work together. This experience is much like what I learned after I graduated from architectural design studios eons ago. It's easy to design something that looks nice if you have any sense of aesthetics at all.

Designing something that looks {or works} nice that can actually be built is a far harder task. In any case, I've got the new print road mapping routine running rather well and am going back to work on my telepresence hand project.

RepRap is going to the NYC Maker Faire!

Monday, 9th August 2010 by Sebastien Bailard



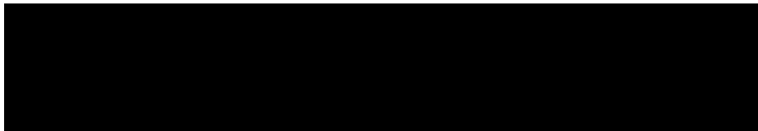
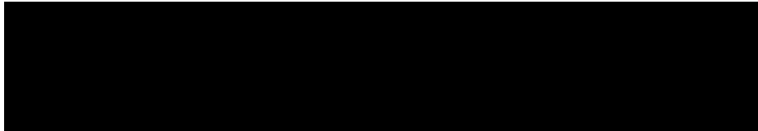
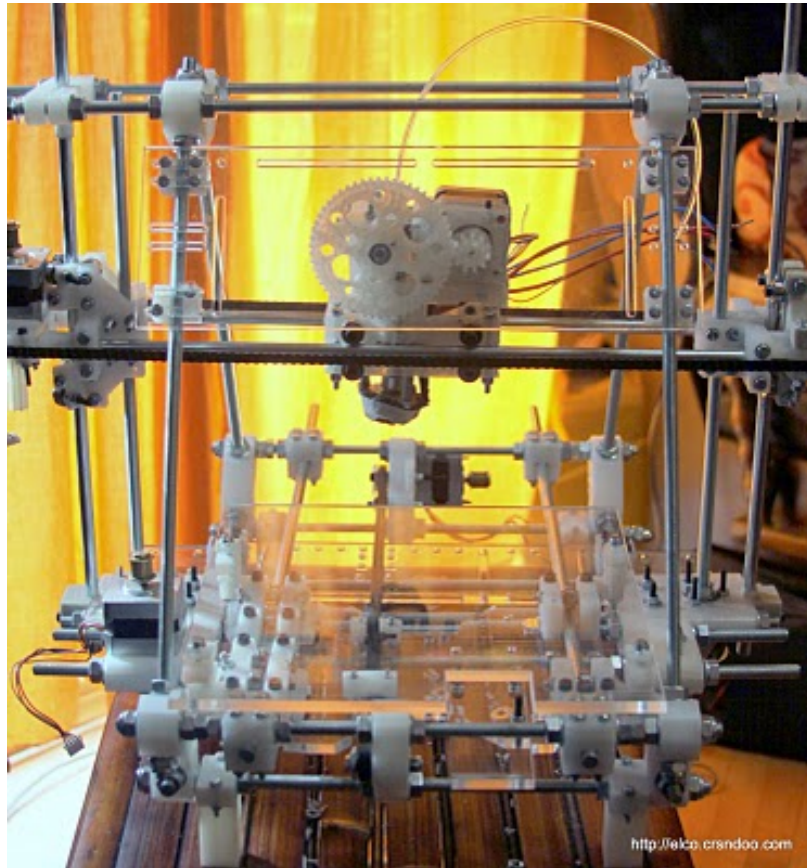



WORLD  **NEW YORK CITY 2010**

Sept 25th & 26th
Flushing Meadows, Corona Park, Queens, NY

Maker Faire
A family fun festival to **MAKE**, create, learn, invent, **CRAFT**, recycle, build, think, play & be inspired by celebrating arts, crafts, engineering, food, music, science and technology.

NEW YORK HALL OF SCIENCE

[Mailing List and Sign-Up](#)
[RepRap Wiki Page](#)

RepRap Version III "Huxley"

Tuesday, 31st August 2010 by Adrian Bowyer

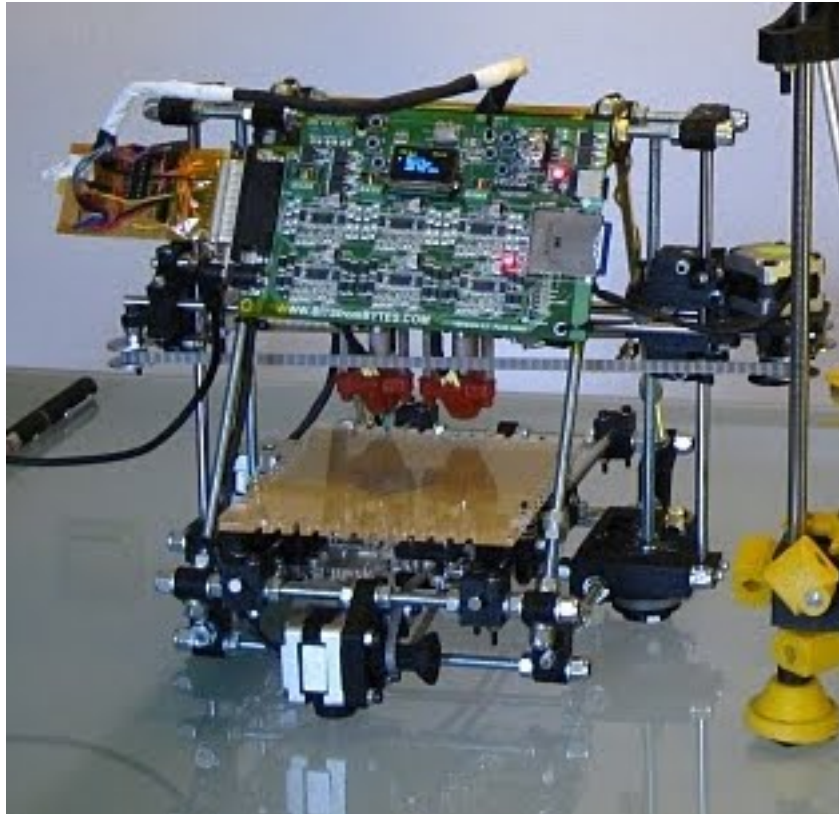

(Image from Erik - thanks!)

I've moved the Mini-Mendel page on the Wiki to form a Huxley page here:

<http://reprap.org/wiki/Huxley>

This is where development of the new machine will be centred. Many people (particularly Erik) have already done a lot of work on Ed's original design.

Please add to their efforts!

A Smarter Approach to Infill

Thursday, 2nd September 2010 by Rhys Jones

As is often the case, I had my Mendel running a week or two ago, and I was sat mesmerised for far too long watching it work. Fortunately, whilst this was happening I had an idea I thought was worth sharing.

Our Mendel happened to be printing a particularly complex part, I think it was one of the extruder driven gear. I made the casual observation that on the lower fine layers, it does a pretty good job. But once you get into the middle layers, it needs to do quite a lot more in air movements compared to the fine layers, as the extruder cannot get to where it needs to be smoothly because of the low density of the infill. The issue with this is that with present extruder designs, and even with reversing, we still get some ooze that makes a bit of a mess. Annoyingly, the reversing and in air movements start at the outline of parts, and the ooze typically spills over a tiny amount, making the part surface a little blobby. It also makes sense that this problem is particularly true for intricate areas of the part, such as the gear teeth.

Thus, It would be very beneficial to vary the increase the infill density within the intricate regions of parts. Not only would this help with ooze, but intricate areas would automatically strengthened with more material. I also suspect that if this was implemented we could also reduce the infill percentage in simpler areas to speed up build time.

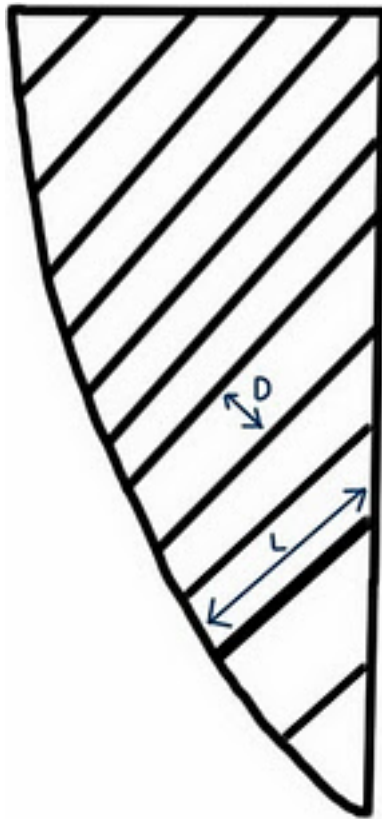

Fortunately, we already have a gauge of part complexity, and that is the length of each individual road within the infill (L) and the distance between infill roads (D) could be made proportional to this length.

Wondering what the fuss is about

Monday, 6th September 2010 by Forrest Higgs

In which your narrator wonders what all the fuss is all about?

I guess I just don't get it. When you work with a plastic, after a while you get a feel for what it can do and what it can't. I started getting along along quite happily with no heated bed and ABS.

I print with a 0.3 orifice at an axis speed of 16 mm/sec. I suspect that I could kick it up to 22 mm/sec without a lot of drama, but I don't want to take the time out to play "who can print fastest" games at this point.

Once I started doing thin walled pieces and no infill my warping problems virtually disappeared. Most of the pieces I design have a largest dimension ≤ 90 mm though I've printed a herringbone rack that was 250 mm long. My acrylic print table temperature stays at about 25-30 degrees. You also don't find my prints warping after a few days from the internal stresses that Bogdan has talked about. I've seen that with HDPE. I was also printing with cross-hatched infill in those days, too. I got into thin walled, no infill after I realised that if I went that way I got pretty fast prints that way at lower print head velocities.

Watching you guys reminds me of the first and second year architectural studio students that I used to lecture to back in my university professor days. They'd make models of buildings out of either "shipboard" {2 mm solid cardboard} or carve them out of expanded polystyrene foam treating it like it was so much cool butter or cheese. We used to say "form follows chipboard". If you followed the careers of those students they usually spent the first five years of their careers designing actual building that got built that looked as if they'd been carved out of cool butter. That's an extremely expensive way to design and build buildings. Those guys either got out of the habit fast or wound up doing architectural detail drawings for other designers who'd developed a feel and respect of the potential and limitations of the materials that went into their buildings. Around here I see parts designed like you were more used to using an expensive CNC milling machine to carve parts out of a block of steel or aluminum.

That looks really cool but begs the fact that you're not taking advantage of the strengths and avoiding the weaknesses of the material you're working with, viz, plastic and extruded plastic at that. Somewhere along the line with Reprap we got the idea that we ought to be able to design parts in any shape we wished and whatever the material wanted to be be damned. You can see the trouble it's caused us in the chase after things like heated beds and support materials. We're spending a lot of time on that chase when we could be designing killer apps that make having a much simpler reprap machine very desirable.

That's just an old architectural technologist talking, I suppose.

I've included [a link of the telepresence hand](#) that I'm currently designing. That is human sized, btw. The largest part dimension is a touch over 80 mm. No warping whatsoever on any part.



Thin walled, no infill, snapped or glued together. There'll be a few screws in it to secure some elastic bands that return fingers to their rest positions. I haven't figured out how to secure elastic bands with snap on parts or glue yet. I'm thinking about how that might be possible all the time, though. :-)

RepRap reprints RepRap electronics

Saturday, 11th September 2010 by Adrian Bowyer

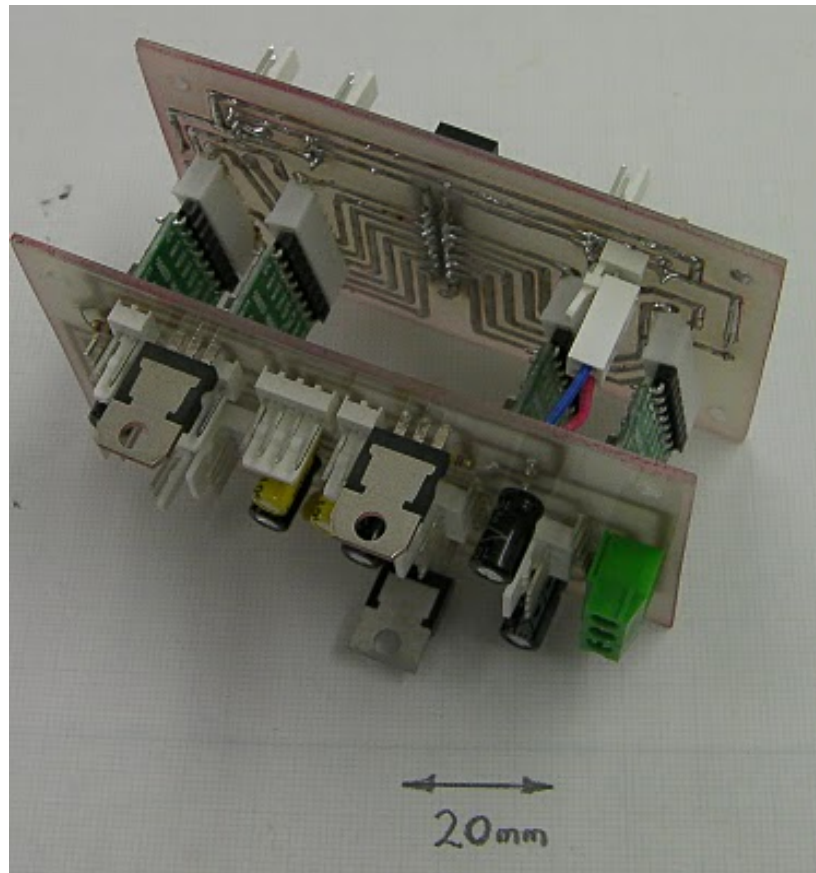

Several people are starting to work on having RepRap make electronics. This includes, of course, making its own circuitry. For example, I'm pleased to say that this blog post itself is rather eclipsed by Johnny Russell's beautifully neat [Arduino Mega Shield made in a RepRap here](#).

I have been integrating PCB production into the RepRap software to try to make it as straightforward as possible. I've used the results to make these:

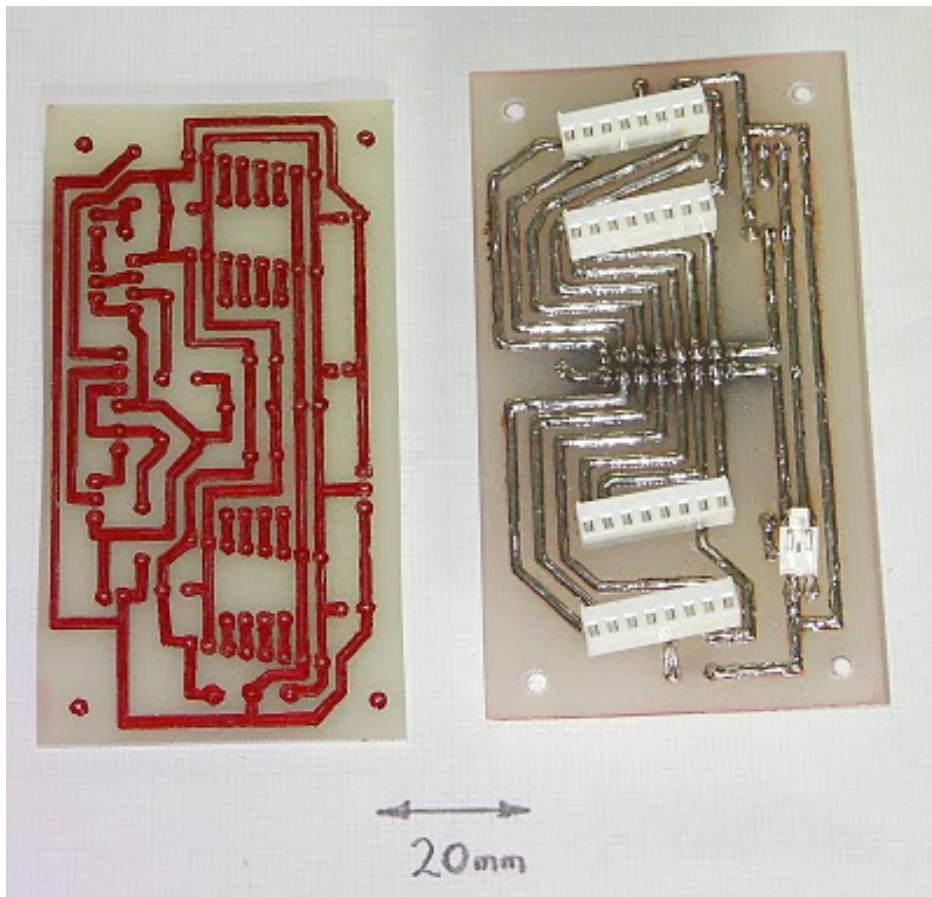

which you can see fully-assembled at the top of this post. They (together with an Arduino Mega) are a full set of RepRap electronics that you can make in the machine itself. [It's all described here.](#)

The software is, needless to say, rather experimental. [It is described here.](#) When it's been tested a bit more, we'll do another release with it in. In the meantime, it's all in the latest code in the [RepRap Subversion Repository.](#)

Mendel Drawing

Thursday, 16th September 2010 by Adrian Bowyer

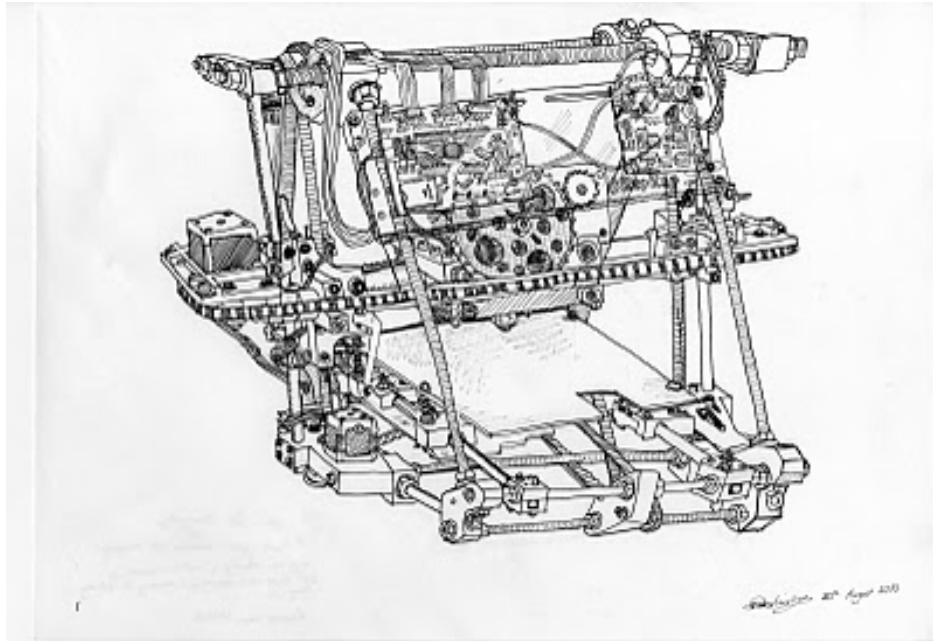

The artist Lauren van Niekerk spend a while in the Bath RepRap Lab recently. One of the things she did was this pen-and-ink drawing of Mendel, which she has given to the project. A 400 dpi scan of it is in the repository here.

Feel free to download it, print it on art paper in your A3 printer, frame it, and hang it on your wall...

Dealing with detaching rafts

Thursday, 16th September 2010 by Forrest Higgs

In which your narrator seems to have come up with a way to prevent raft peel for ABS on an acrylic print table.

About two weeks ago, the rafts for my ABS prints started detaching from the right hand side of my print table. I was losing one out of two to one out of three prints that way. At first I decided that my acrylic print table had simply got too warped and I had too much variation in level on the acrylic. I removed the acrylic print table and checked its flatness with a milled straight edge. Indeed, it was a little warped so I used a belt sander on it till it was as flat as the milled straightedge. That seemed to work for about an hour but I was soon back to where I began. I then decided that the table was now adjusted properly and went to a great deal of trouble getting it so on my Rapman. Same result.

In desperation I began to print on the left hand side of the print table and the problem went away. It was still troubling, though.

On Tuesday, I finally caught on. In the last weeks the weather had cooled to where the outside temperature was in the teens more often than not and dropped into the single digits {Celsius} in the early mornings when I began to work. I looked at the printer table and noticed that the window I used to ventilate the work area was on the right hand side of the printer. The next time that I had a raft detach I measured the acrylic work surface temperature with my IR thermometer and discovered that whereas it was about 25-26 C on the left hand side of the table the draft from the window dropped that to 22-23 C on the right hand side. I was rather shocked that I got that wide a variation in surface temperature over a few centimeters distance, but I certainly did.

I closed the window and the peeling instantly stopped.

That remedy wasn't workable because of the ABS fumes, so I rigged a portable heat lamp onto my camera tripod to shine on the print table.

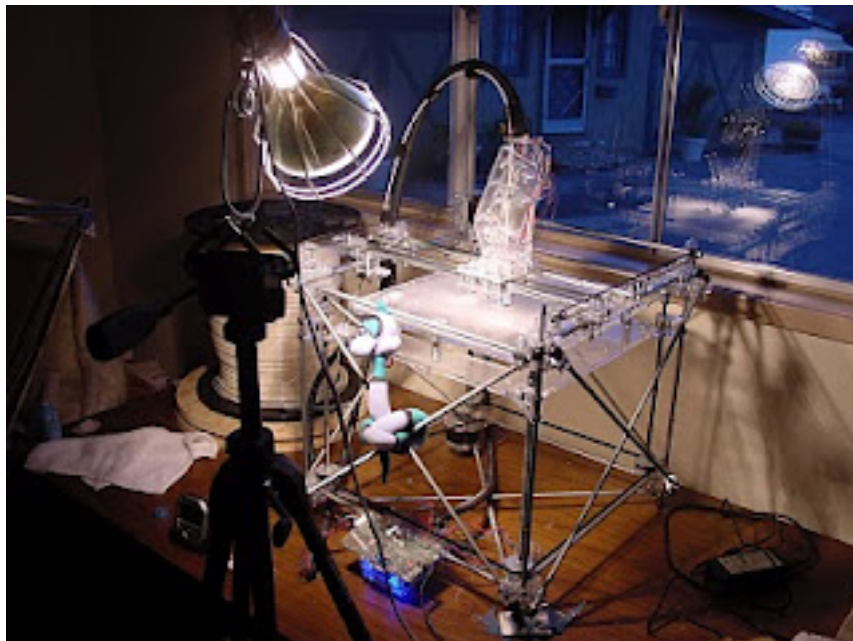

The radiant energy keeps the acrylic print table at 34-40 C with the window open. I haven't had a raft detach since then. I've done a few dozen prints, mind.

Dem Bones

Sunday, 26th September 2010 by Forrest Higgs

In which your narrator creates a way to separate parts from an undifferentiated OBJ file scan of the bones in a human hand.

Recently, I came to the conclusion that it was going to be very difficult to achieve anything like the degrees of movement with a human hand in anything like the same size as a natural hand. The Shadow Robot Company gets about as close as you can get by achieving 20 of the 27 degrees of freedom possible with the human hand.



If you look at the kinematics of the hand, which are the best in the industry, you'll notice what amount to pin joints. While I have no trouble with them, they're extremely hard to do with printed ABS. As a result, I've begun to look at a more biomimetic approach which has had me looking much more closely at how a hand is put together.

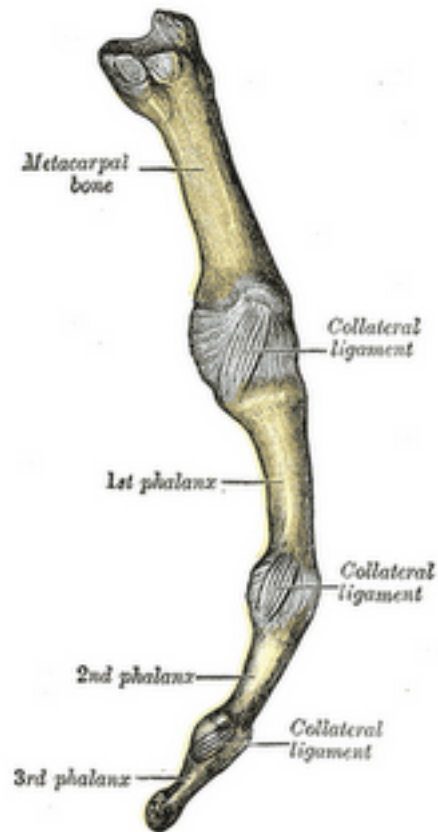

When you look closely at how the joints and joints in the hand are put together you see a series of strip ligaments applied like bandages to the joints to restrict and control movement. Oddly, the colouring of the Gray's Anatomy drawing twiggled my thinking. The bones are pretty much the same yellowish tint that the ABS I print turns to several weeks after being printed. The grey-white of the ligaments looks just like the polypropylene that I did a bit of work with a while back. I found polypropylene a bit too rubbery for my purposes back then but then I realised that polypropylene is famous for being useful as a plastic that can stand flexing, a perfect match for ligaments. As well, there was the small matter that I'd acquired some 80 lbs of 3 mm polypropylene filament over a year ago at a clearance sale for about \$1/lb. What if I made bones out of ABS and ligaments out of polypropylene? With the powerful Rapman extruder there was no systems limits on that approach. First, I had the problem of finding a proper depiction of the bony structure of the human hand. Several hours with Google led me to this offering from [Turbosquid](#).



Search as I might I was not able to find an open source scan of the human skeleton or parts thereof. The Turbosquid depiction was inexpensive {please don't write me about better deals, I suspect I've already found them} which suited my tightfisted Scots-Irish nature, but the product was presented as one OBJ file, which made separating out the individual bones a rather daunting task. Most firms like Turbosquid provide their scans in a variety of formats, most of which work with expensive 3D CAD systems leaving only the OBJ file, which doesn't have intrinsic parts separation, available for use in my preferred 3D CAD system, Art of Illusion (Aoi).

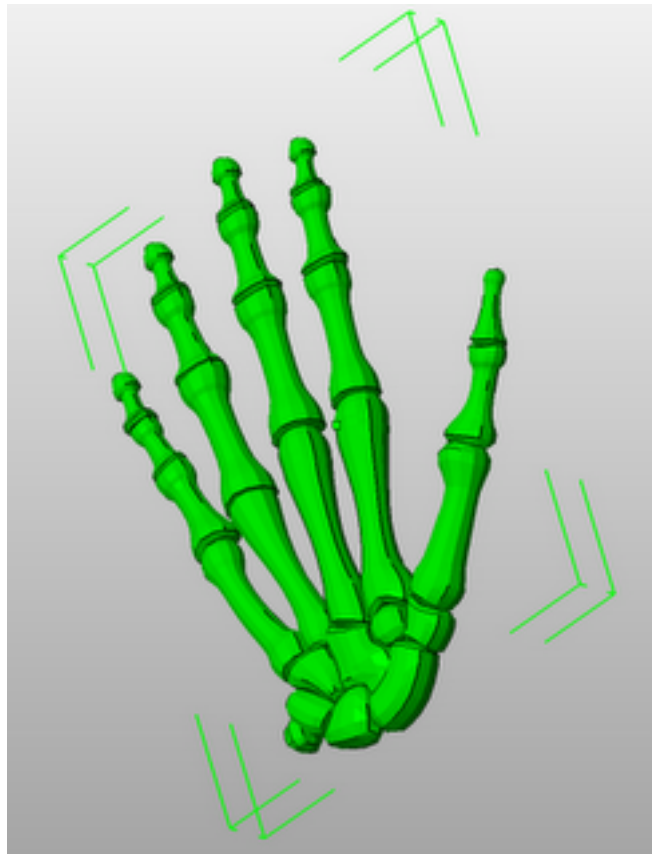

I continued my Google search and discovered that if you wanted the bones disarticulated you wound up paying several thousand dollars for a whole skeleton scan. That was a non-starter.

Thus, I was left with trying to figure out how to separate the parts. My first notion was to use cutting blocks in Aol. A few goes at that showed that it was entirely possible but extremely fiddly work.

I then began to wonder how big a task it would be to go in and separate the individual bones in the OBJ file?

The OBJ file format is a rather primitive one that simply includes a list of the 3D points in the point cloud describing the surface of the object(s) followed by a list of triangles containing all the points which make a surface mesh over the object(s) described in the file. The OBJ format specification is a rather mutable thing and the Turbosquid specification included a lot of textural data and a peculiar triangle specification affectation that I'd never seen before. Fortunately, when I imported the hand bones OBJ into Aol and then exported it again, it came out in the simple, elegant Aol format.

I wrote a small Visual Basic .NET app to separate out the bones in VB.NET 2008 Express, a powerful development environment which is distributed free by Microsoft.

How it works

The process I followed can be described...

Initially: break the OBJ file into two lists, the point cloud {List 1} and the triangles descriptions {List 2}.

1. take the first triangle in the triangle list and put it into a fourth list (List 4) and delete it from List 2.
2. get the three pointers from the triangle and put them into a third list (List 3) that is sorted from smallest to largest.
3. Collapse List 3 to include only unique pointers

4. Take the first pointer out of List 3, delete it from the list and then find all triangle descriptions in List 2 that contain the pointer and add those to List 4 and delete them from List 2. Add the pointers in each of those triangle descriptions to List 3 and collapse the list again.
5. Repeat 4 until List 3 is empty. You've now got the list of triangles describing one of the pieces in List 3.
6. When List 3 is empty, create a separate OBJ file for the individual piece by copying List 1 followed by List 4 into an individual file.
7. When this is done Repeat the process starting at 1 until there are no triangles left in List 2. You will then have an OBJ files for each unique, separate piece in the combined OBJ file that you started with. Aol doesn't care if there are unused points described in the point cloud. If you want to get rid of superfluous points you have merely to import the individual OBJ files into Aol and export them again. This does not happen, apparently, if you import the OBJ file and then try to immediately export it as an STL file.

I've zipped up the code for this little app and put it on my website. You can access it [here](#).

The hand bone assembly from Turbosquid is not included in that as I read the license I can't redistribute it in its original form. I'm not sure about that, but I'm not into having that kind of drama with them.

Walking through the app

I'm assuming that you have some familiarity with VB.NET and want to run it from the development environment. Understand that I'm not happy acting as a help desk for my code. If you want to use it you're largely on your own. That said, I'll give you a little walk-through.

Here is what you see when you activate the app.



When you punch the open object file button you're taken to the Object Data folder within the app.

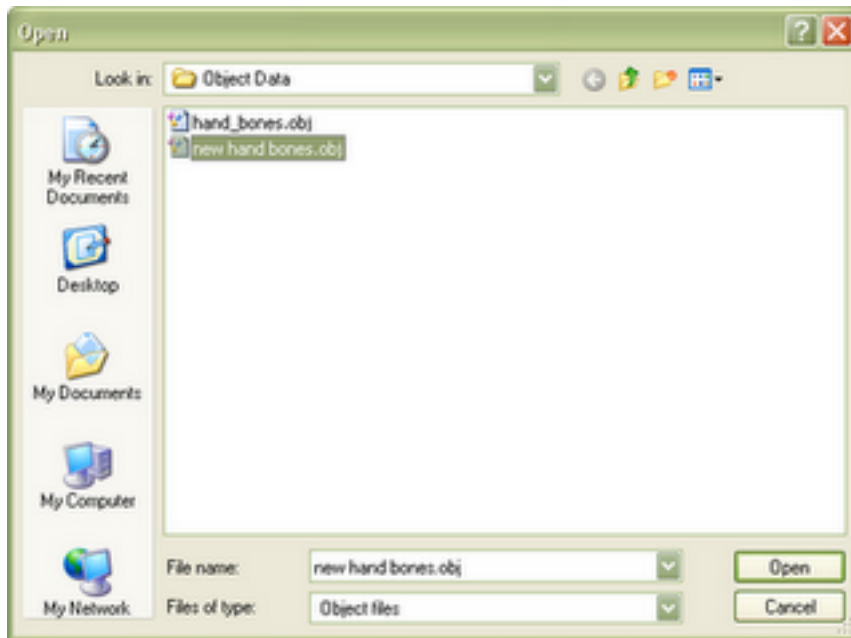

You can navigate to other folders but this is the default folder that is opened. You select and open the OBJ file you want to break up. That leaves you with something that looks like this...

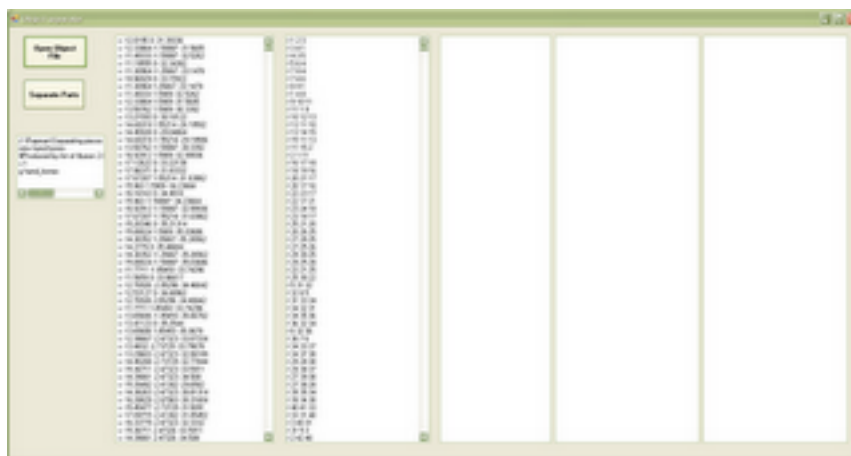

...with the point cloud descriptor in List 1 and the triangle descriptors in List 2. When you've done that you then punch the Separate Parts button and wait for it to finish. It's pretty fast on my machine, but it can take a while depending on the complexity of what you are trying to separate. Once it's done you can go find the Output folder which you can see here...

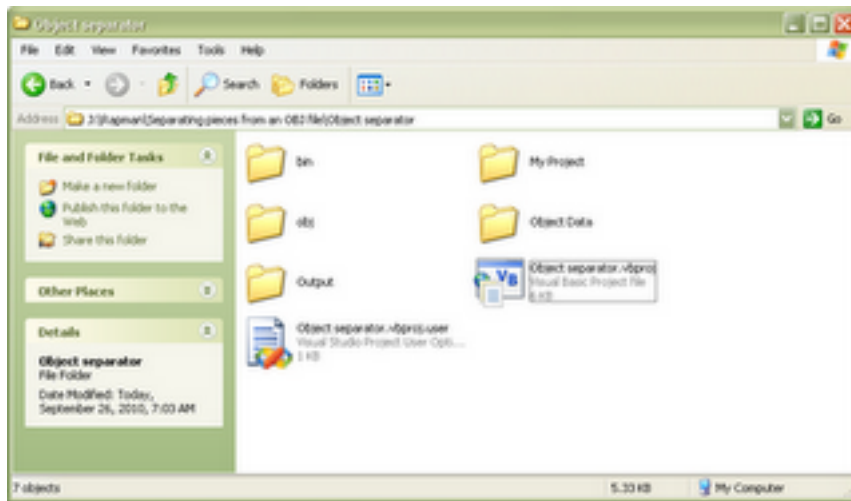

You can also see the Object Data folder in this pic.

Looking inside the Output folder, you will see that your original OBJ file has been broken into as many numbered files as there parts in your original OBJ file.

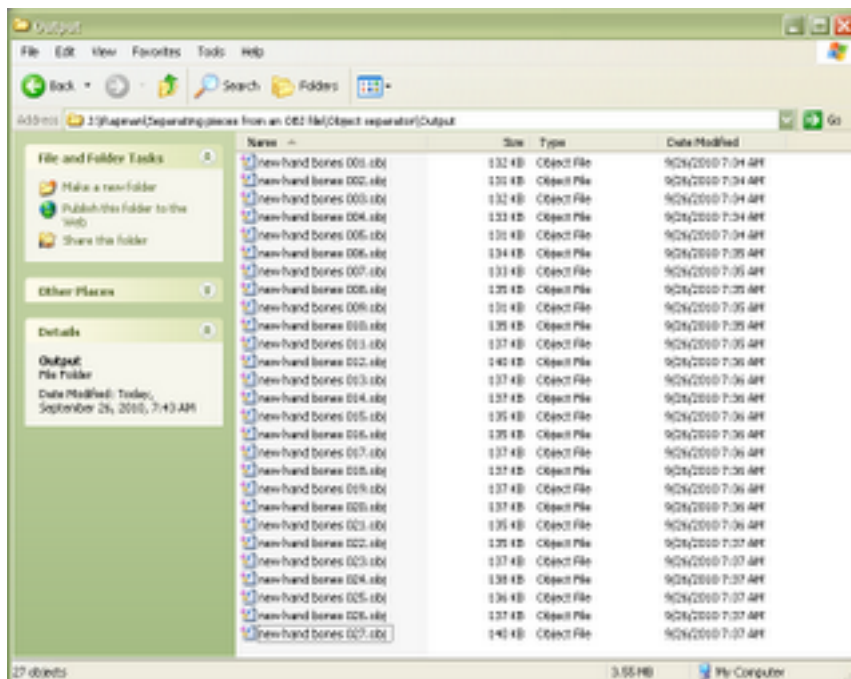

You can then take those into Aol and convert them to STL files for use with either my own Slice and Dice app, Skeinforge, Netfabb or any of the other apps that prepare print files from STL files. You can see how this separation process works by looking at the #12 file of the hand assembly.

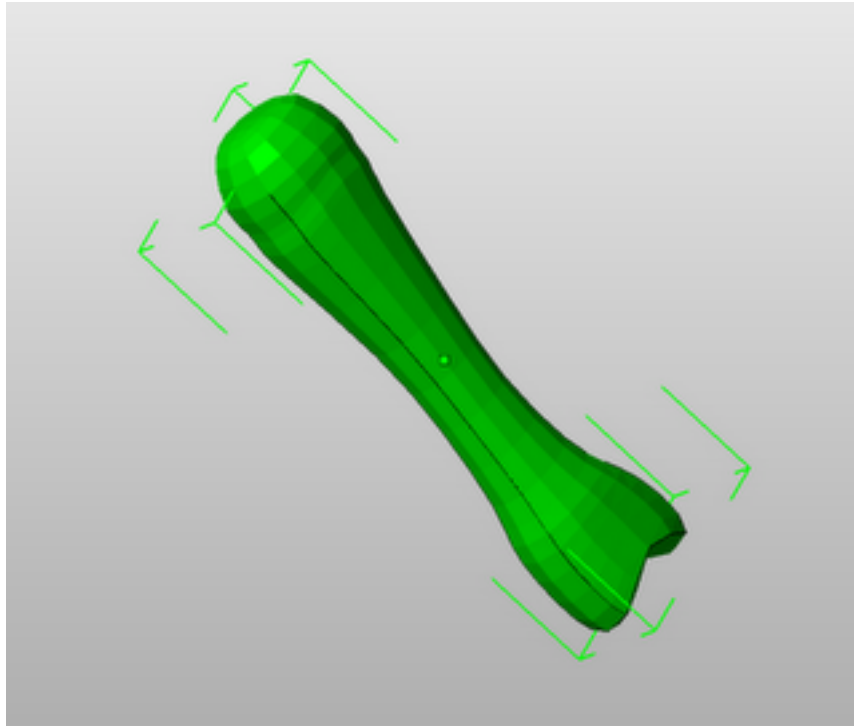

Like most of my work, I'm more interested in demonstrating methods and approaches than in creating out-of-the-box apps. I know most of you are much more interested in Java, the good Lord save you, and Python than the Wintel-only Visual Studio and Visual Basic development environment.

Have fun! :-D

Story of simpler Mendel: PLA bushings and X-axis

Monday, 4th October 2010 by prusajr

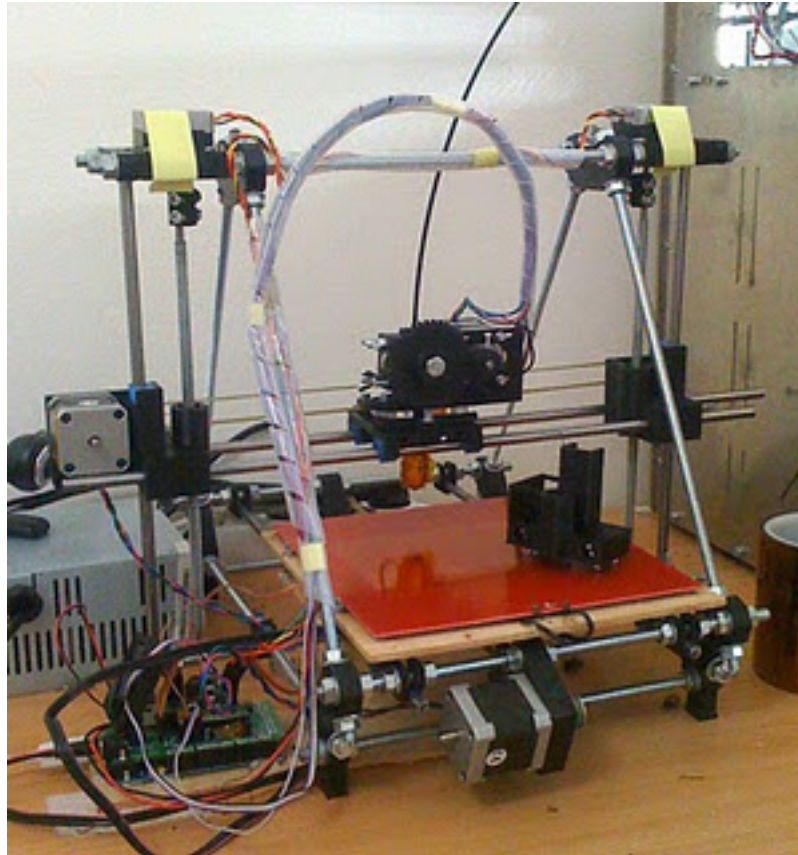

Hello, I'm new here so I guess I should introduce myself first. My name is Josef Prusa, I'm 20 years old student from Prague, Czech republic and I'm in RepRap world for about a year now. You can follow me on <http://twitter.com/prusajr>

2 months ago I started process of simplifying Mendel design, so far I was able to reduce parts count, assembly time, use of vitamins and also price. I introduce my simplifications in few articles here on blog. Here is wiki page http://www.reprap.org/wiki/Prusa_Mendel, its not updated yet to final state, but I'll do it soon. You can always find most recent files on my GitHub <http://github.com/prusajr/PrusaMendel>.

RepRappable PLA bushings

Great alternative of bearings, if you dont have huge load. VikOlliver inspired me with his set of parts,

using PLA "sleds". This is radically improved, tho.

Also, it makes whole x-carriage snap on to axis rods :-) Its great if you are experimenting with extruders a lot!!

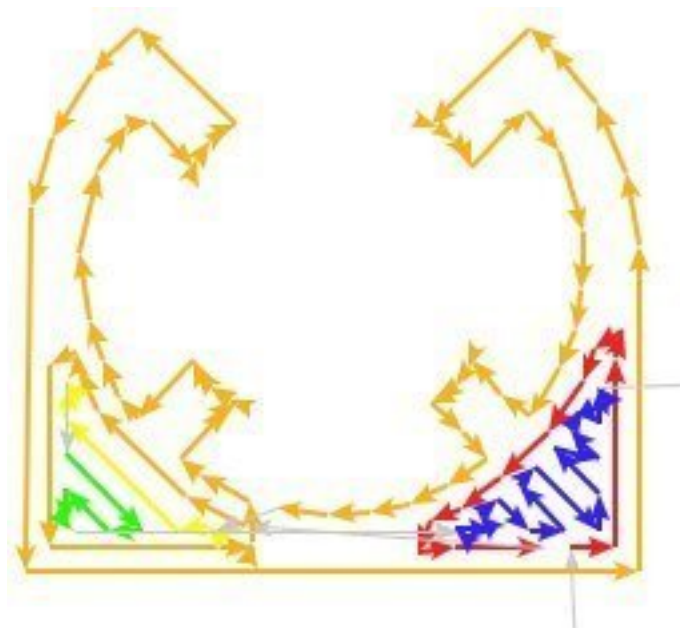
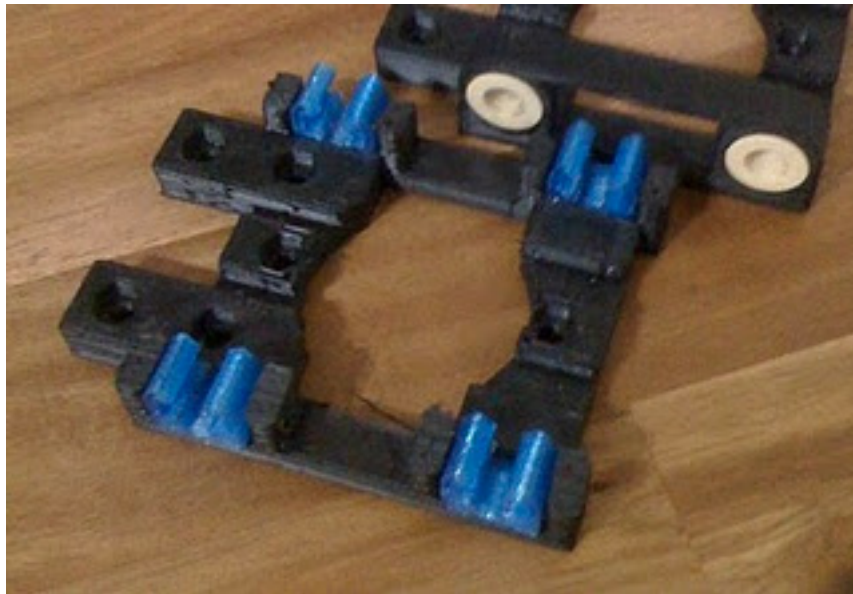

They sits really nicely on rods. With regular Icus bushings I had a problem, because I dont have bearing rods, it was all little wobbly.

I printed about half of regular Mendel with these on all three axes and they are still good as new. Quality of prints with them are also comparable with linear bearings which I have on RapMan.

They will not last forever, thats obvious, but price for us RepRappers is near \$0 which makes them nice alternative. I also designed all parts to be able to change the bushings when they worn-out.

You can find files and instructions how to use them on <http://www.thingiverse.com/thing:4177> and I'll soon make a Wiki page for them too.

X-axis

X-axis is where I actually started my redesign, there is originally like gazillion parts and its real mess to assemble it. My version only has three big parts, two belt clamps and few printed bushings. Parts also includes Z axis functionality. Its really easy and simple design.

Parallelnes of two main rods is ensured by the teardrop type of holes for rods plus securing bolts from bottom (there is nut bracket inside the part). By pushing the rods upside, they will self center.

You can see the principle here on cut part. (Note: its older version of x-end-motor, principle is still same tho)

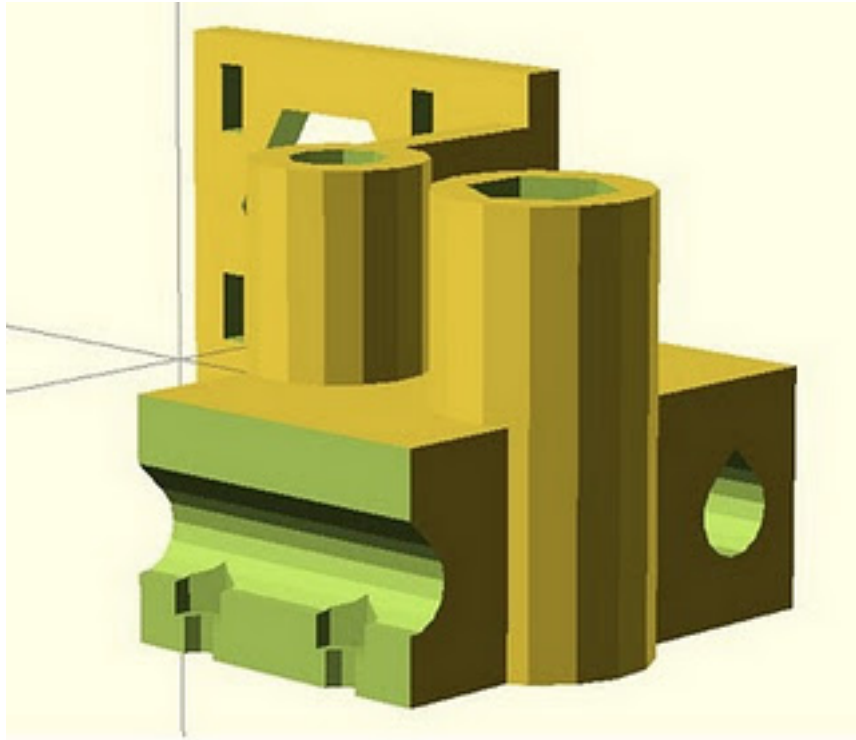

X-carriage

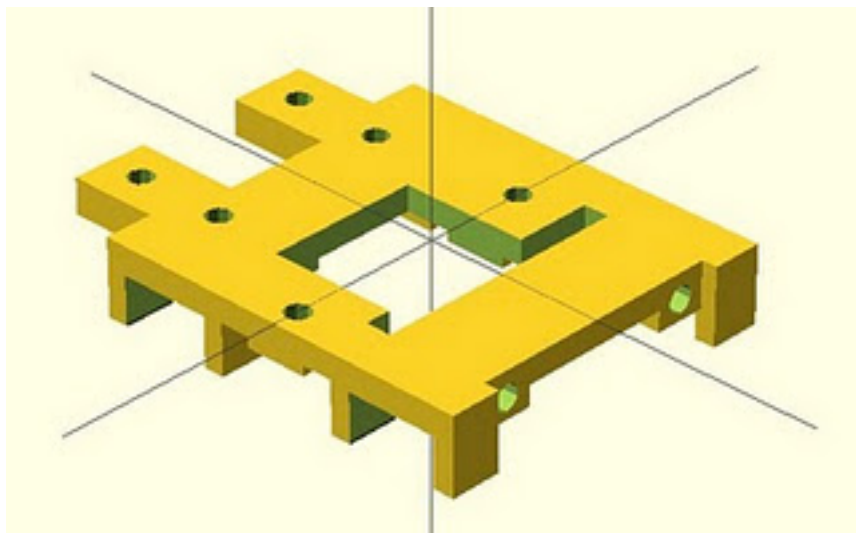

X-end-motor

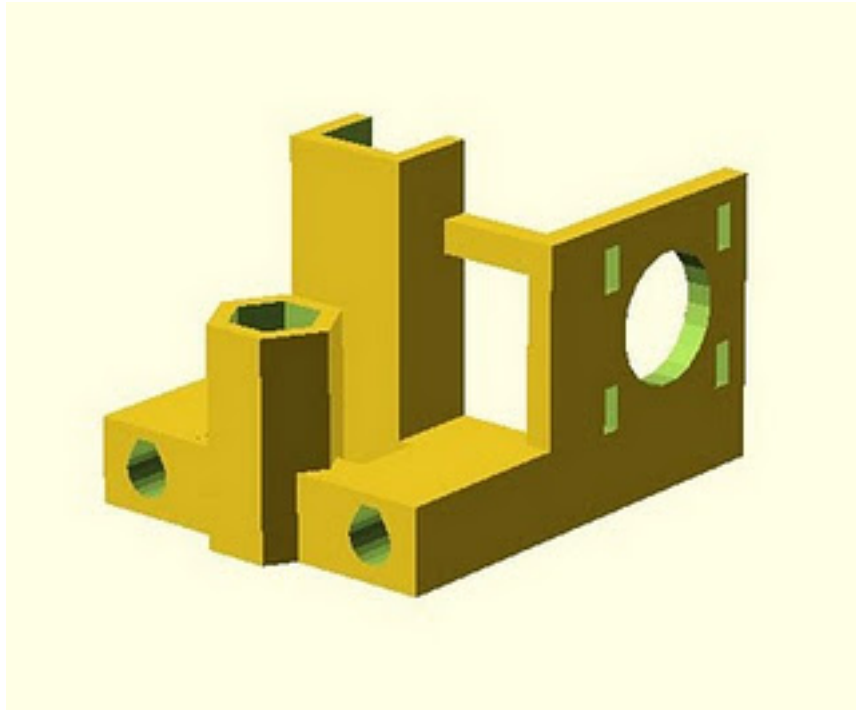

X-end-idler

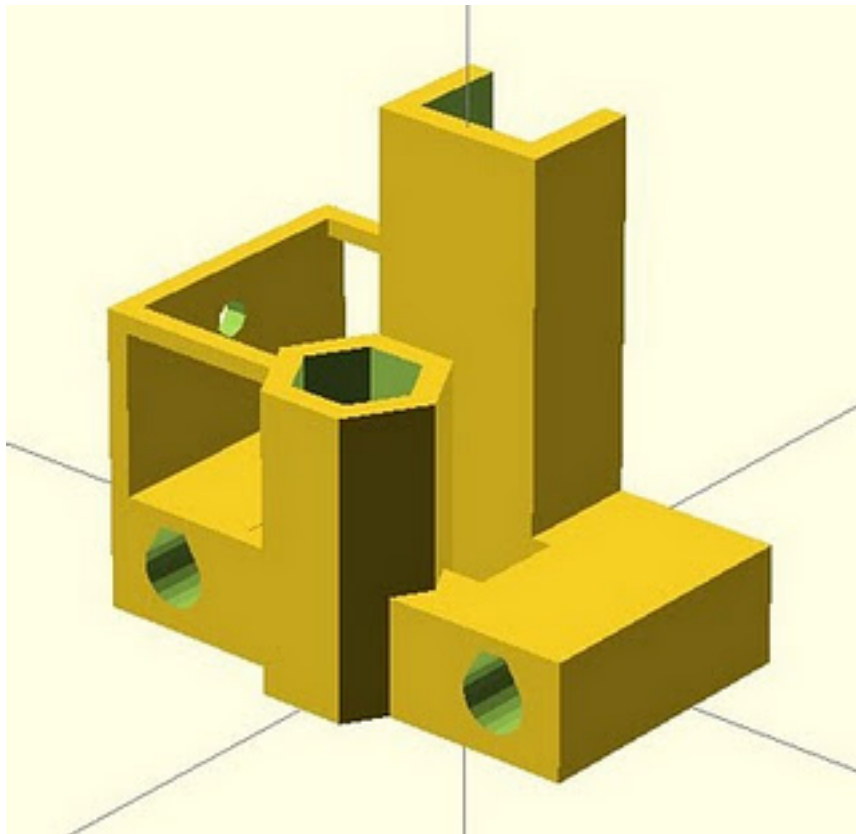

I hope you like it! Next time I'll introduce Y and Z axes.

(Note: This is still development!! Not officially released.)

Replicating laser-cut parts

Sunday, 10th October 2010 by Forrest Higgs

In which your narrator confects his own idiosyncratic method of replicating laser cut parts.

The recent acquisition of the UK manufacturer of the reliable Rapman printer, BitsfromBytes {BfB}, by the American firm 3D Systems has exacerbated a long standing problem that the Rapman's users' community has had, vis, getting drawings of the laser cut acrylic parts that make up the system. While BfB uploaded drawing files of one of their early Rapman designs into the Reprap website, they have neglected to do so with version 3.0 and later models to the best of my knowledge.

That wouldn't be such a problem save for the fact that the acrylic parts in higher stress parts of the Rapman tend to develop shear cracks and spalls after hundreds of hours of operation. Rapman owners are then left to either request replacement parts from BfB or print their own spares. Interestingly, there is a healthy spares design effort underway for the Rapman, part of which is hosted on the BfB website itself.

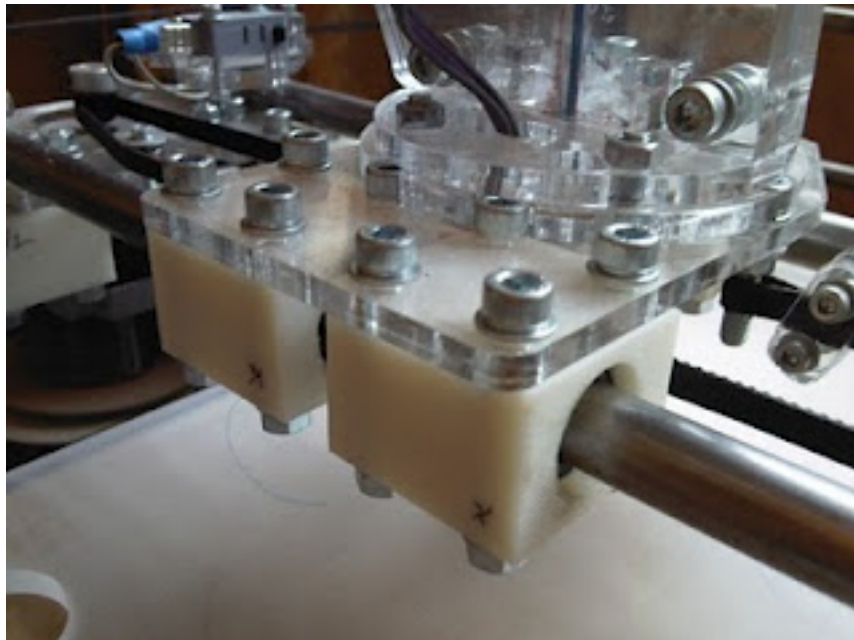

Here the printed white ABS grips for the x-axis linear bearings replace the lower plate for the extruder carriage in a much stronger configuration than the original. Indeed, at this moment, there is a very exciting redesign of its printable parts underway by an Australian newcomer that greatly reduces the print time required for what were finicky corner blocks.



All this aside, there are many pieces in a laser-cut printer that simply need to be printed as-is in ABS rather than redesigned. Heretofore, I found myself carefully tracing the parts out on paper and using calipers to get the dimensions. While that approach works well with many parts some, like the extruder z-depth stop plate are much more problematical.

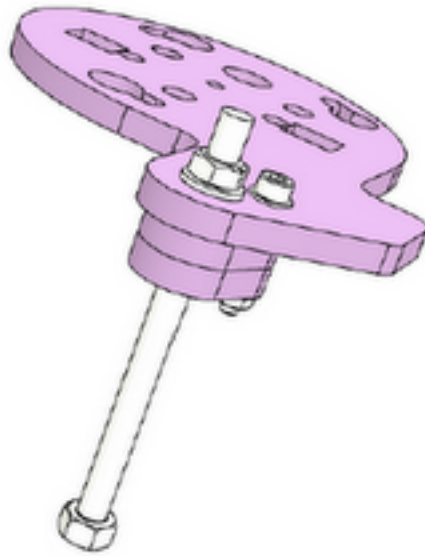

This particular plate is the antithesis of rectilinear and locating the holes and pockets is tedious to put it mildly. I'd thought that it ought to be possible to use an ordinary 2D scanner to capture this sort of information. Today, I gave it a try and discovered that it was not as straightforward an operation as I'd imagined.

I had an extra copy of this part that I'd bought still in the protective blue film, so I threw it in my Epson Perfection V500 Photo scanner, a very cheap and extremely high resolution machine.

Even with the blue film the image captured didn't have a lot of colour information that would let you think that you could separate the part from its background.



I pulled that one into Slice and Dice and tried to separate out the image with RGB manipulations to no avail. I then tried putting a intense red background behind the piece figuring that the blue would override the red and tried playing with the colour mixes in both Slice and Dice and Photoshop, again to no avail.



Two things were killing me; the transparency of the part and it's depth, which you can see very clearly in this scan. When I tried to just capture the edges by going high contrast, the depth of the object spoiled everything.



It occurred to me that I could paint the part on one side with tempera paint, which can be wiped off of slick surfaces. Rather than drive into town and given that the part was already protected with a blue film I simply spray painted it with red enamel. I then put it back in the scanner with a piece of dead black HDPE sheet behind it and instantly got the colour separation I needed.

Popping the scan into Slice and Dice and filling the black with green, I had an image I could work with. As you can see, it was a little nasty, largely due to the messy laser cutting on some features and a bit of flare here and there.

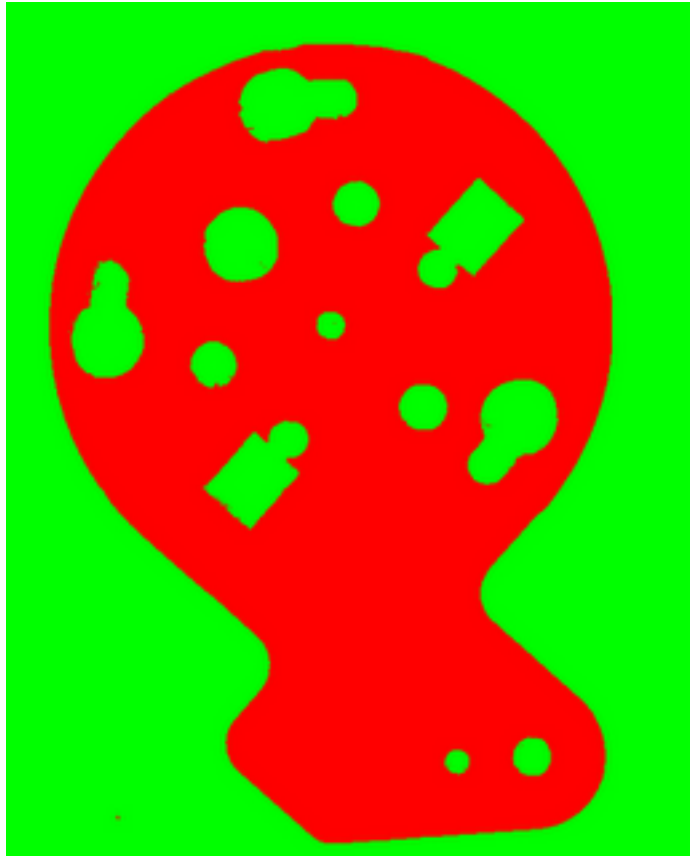

A few moments in Paint cleared that up.

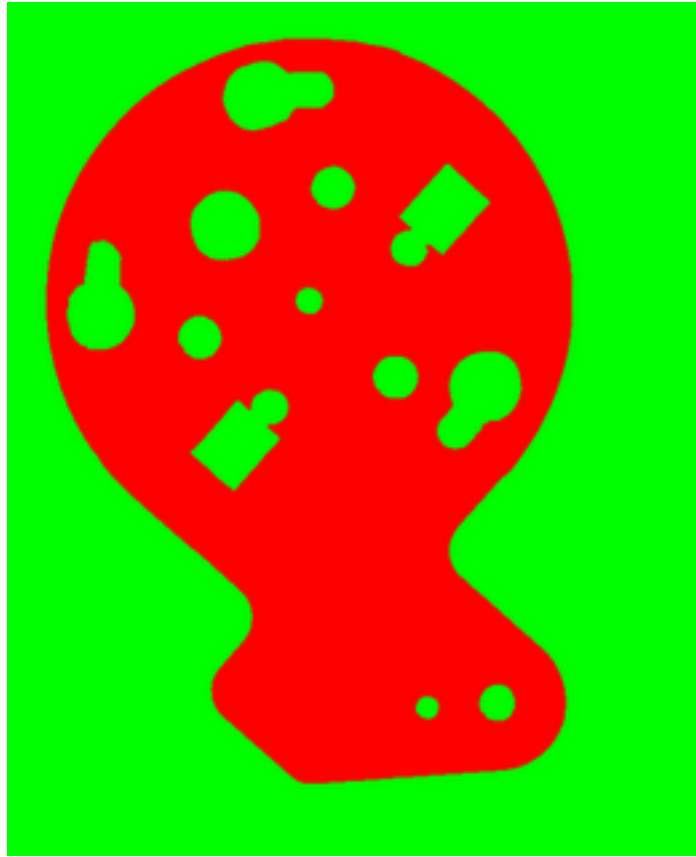

Now that I had crisp colour separation, defining the part boundary in Slice and Dice was trivial.



While I was in paint I took the pixel counts across the diameter of the outer circular feature boundary and measured the same feature on the part with calipers. I then adjusted the size of the image in Paint.

With a bit of pushing and shoving in Slice and Dice, I processed the part and created a print file. Here you can see the print roads for the part.

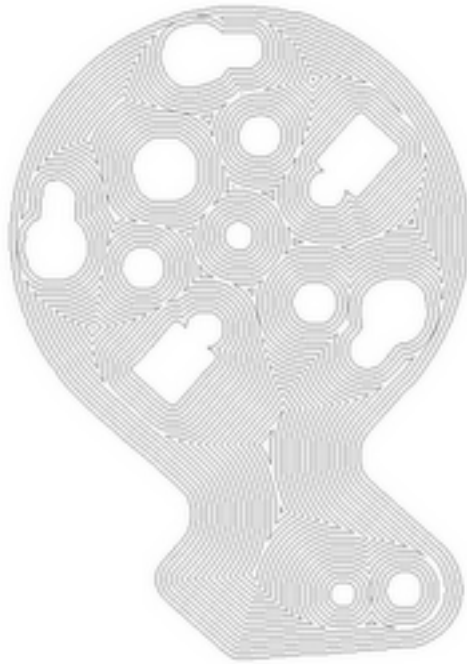

With a print file, I did a trial print to check the dimensions. The acrylic part lay precisely over the printed part.

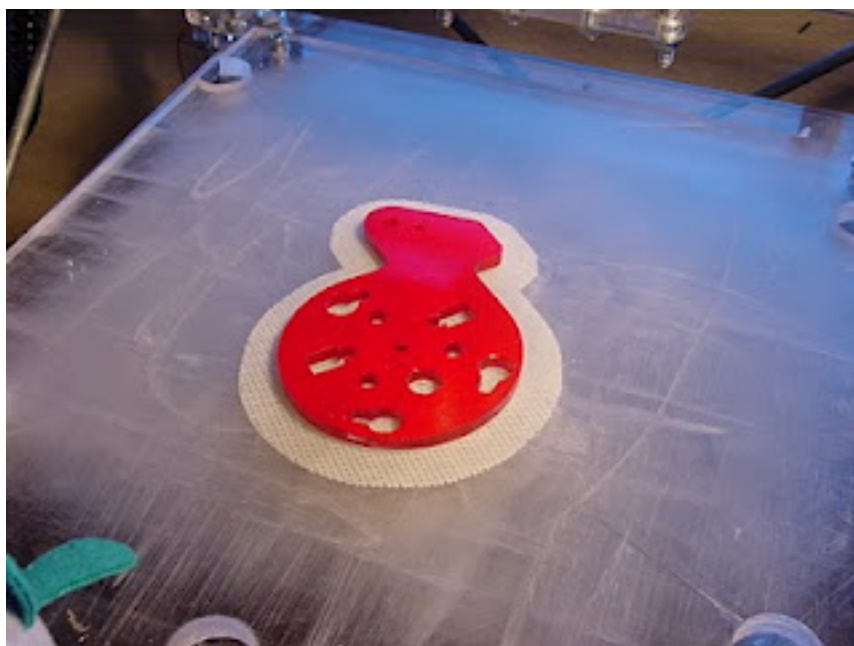

I photographed it again with the original part slightly ajar so that you can see the holes in the print.

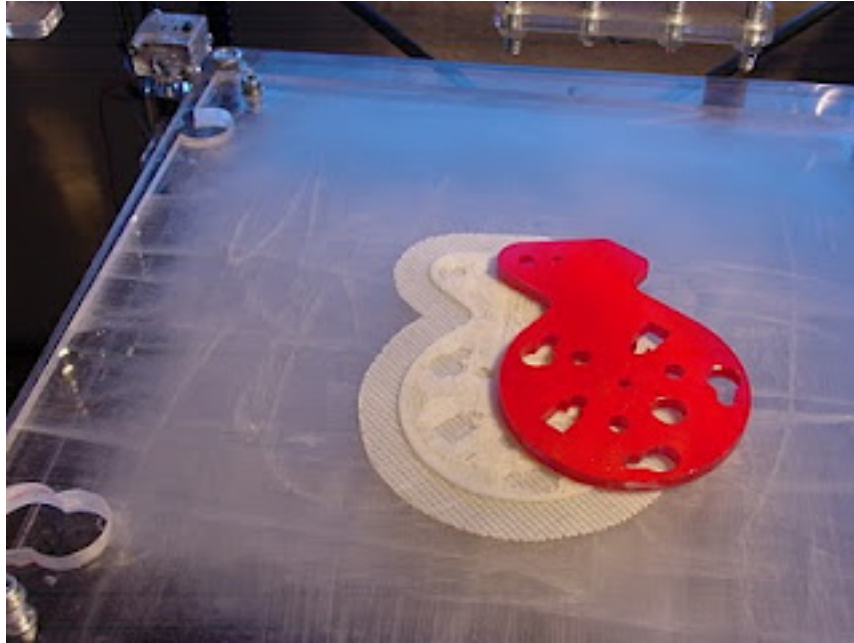

If you look closely at the several layers of part print that I ran before aborting it you can see that I need to increase the print flow a touch. More importantly, with a part of this size and complexity, however, I am going to have to write a routine that makes a better job of reducing transition distance between print roads. Transitioning was taking far too much of the machine time. That's on my "to do" list now.

What I've demonstrated here is not a smooth operation on Slice and Dice just yet. I was mostly trying to prove the concept. That was a huge success. What this means is that owners of laser cut reprop machines can readily exchange parts information with nothing more complicated than an ordinary 2D scanner and a set of calipers. This should give us considerably more flexibility than we have at the moment.

I am certain as I finish this blog entry that someone is going to show me a simpler, faster way to do this in a few hours. That's certainly happened before. If not, though, we have this approach. :-
D

Story of simpler Mendel: Y and Z axes

Wednesday, 13th October 2010 by prusajr

My Mendel redesign is slowly reaching first milestone. I have completed a fully working prototype. I already fixed almost all issues that came with building it. Now, my attention turns to doing the basic documentation, then we're ready to rock'n'roll! I foresee it's going to be huge success for the Mendel replication rate. All the parts needed can fit and print them all on one Mendel sheet!!!

Z-axis

I chose to use two steppers wired in parallel to one driver. I know, it's controversial, some people don't understand it, or even like it. In testing so far, I can find only positive things to say about it vs the regular timing belt design. My hope this blog will open your mind. If you don't wish to try it, you can use older Z axis, the design is still compatible!

Motors are on top side, recessed in holders so they can't rotate, but they are free to self align in X direction. There's a possibility to secure them with bolts, but I found it's actually much better to let them be free and "secure" them with only something flexible like tape, this together with freedom in X axis arrest really lots of wobble! You can't achieve this with older design.

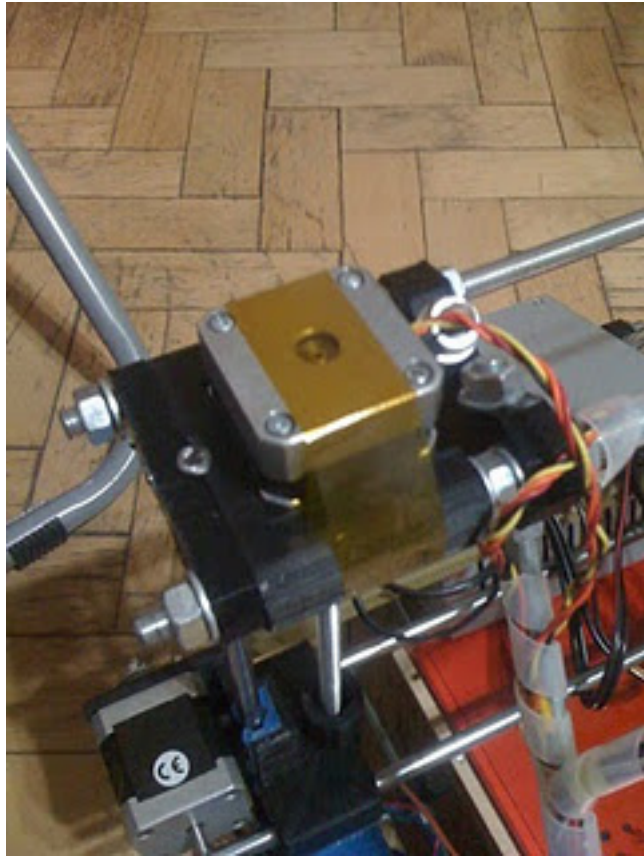

Next great thing is nut trap part of X-end parts. Its clever design I've discovered on Darwin and I'm surprised that I'm the first who brought it to Mendel. Theory is on picture. In practice it smooths out whole Z axis, since it keeps the nut really securely on the stud.

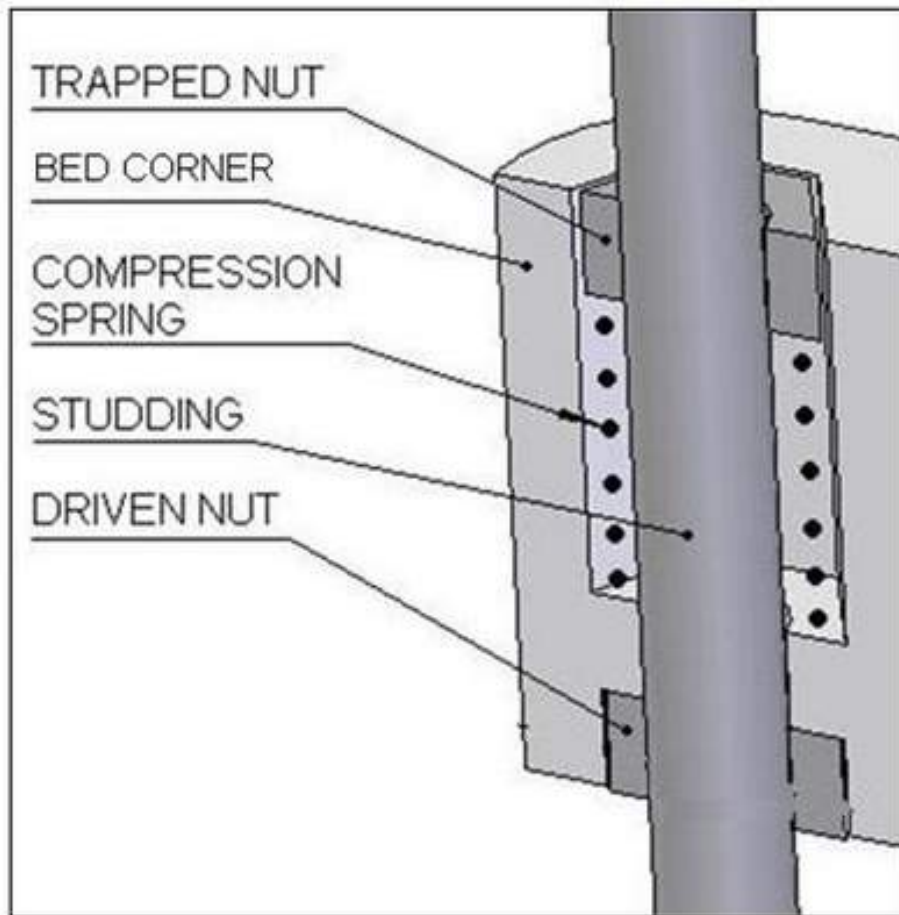

All together enables Z axis to go upto 260mm/min and probably even faster, but my FW cant handle more steps, since I'm using 1/16microstepping.

Y-axis

I was little scared at first about redesigning Y axis, aware of the parts count and assembly time on standard design I wasn't sure if I can do it more simple. At the end it turned out as simplest axis of all. I even get rid of need for the laser-cutted parts.



Process is very simple, after you install Y axis bars, you snap on four bushings, align them at about the size of the board (12x22cm), put some glue on them and place the board from top. There is no need to be extra precise when aligning the rods, bushings can absorb some error :-)

Rest should be obvious from picture. I've already found better solution tho. Again inspired by Vik! Just use two skate bearings as here <http://www.thingiverse.com/thing:2011> , it eliminates idler part and moves half of the belt on top of the smaller board. Unfortunately I wasn't able to test this yet.

Conclusion

I can print with this machine at 50mm/s without any problem. Objects are as smooth as possible for FDM technology. I will post detailed photos soon, shame I have now only iPhone for taking pics :-)

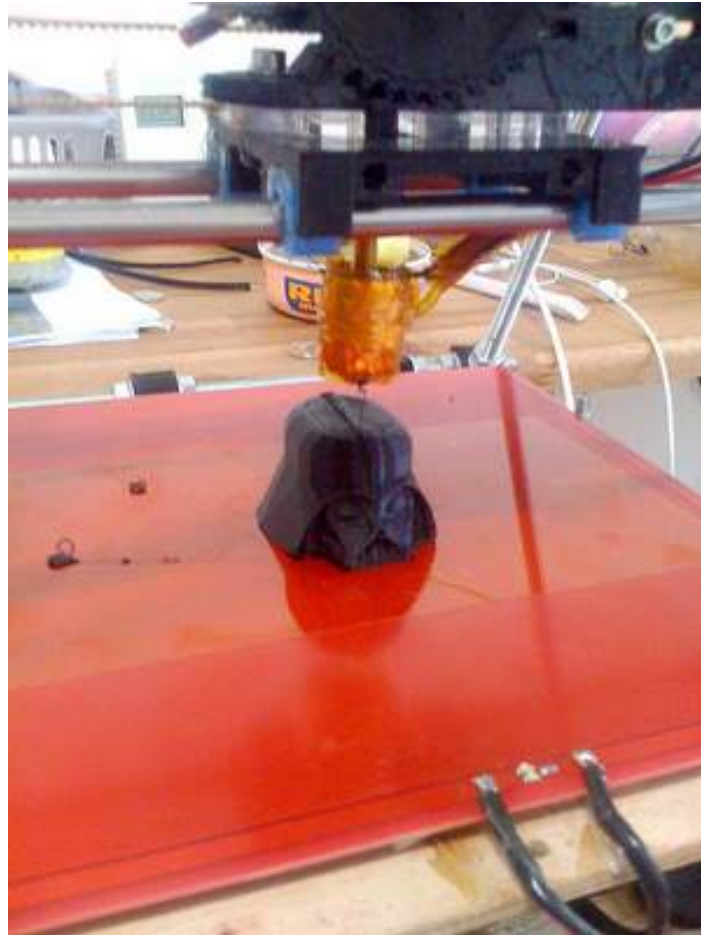

Most recent files are at my <http://github.com/prusajr/PrusaMendel> dont forget to watch them. Now I will focus on documentation. Construction is really much simpler, I bet it can be built faster then Makerbot ;-)

BTW Look how awesome these parts look printed on Stratasys from [Azdle](#).



The Gada Prize

Saturday, 6th November 2010 by Adrian Bowyer

We are pleased to announce that Humanity+ has taken over the hosting of both the Initial and the Grand Gada Prize for Personal Manufacturing.

These prizes are offered for free and open-source RepRap machines that are significant improvements over the current generation of machines.

To stand a chance of winning you have to register your intention of entering and to publish your developments regularly - we all wanted to make sure that the prizes didn't drive people to develop work in secret, as that would be the exact opposite of what RepRap stands for.

Seventeen teams and individuals have already entered. Entry is free. It is also still open, and will be for quite a while.

So why not have a go!

3D printing and "Intellectual Property"

Wednesday, 10th November 2010 by Adrian Bowyer

A while ago a few of us wrote a paper:

<http://www.law.ed.ac.uk/ahrc/script-ed/vol7-1/bradshaw.asp>

on the "IP" implications of home 3D printing. This looked at the matter mainly from the UK and EU perspective.

Inspired by that, Public Knowledge, a Washington DC based public interest group, has now put out a white paper on the same questions from a US perspective. You can access it here:

[It Will Be Awesome if They Don't Screw it Up: 3D Printing, Intellectual Property, and the Fight Over the Next Great Disruptive Technology.](#)

Random thoughts on hot-end design

Friday, 26th November 2010 by Bogdan Kecman

I spent some time modding the bfb hot-end. Originally the hot end is very sturdy but with extremely soft filament (soft-abs from orbi for example) it is not able to print at low speeds (0.25mm layer 16mm/sec was on the limit, working but not consistent, 0.15mm layer 16mm/sec killed it)...

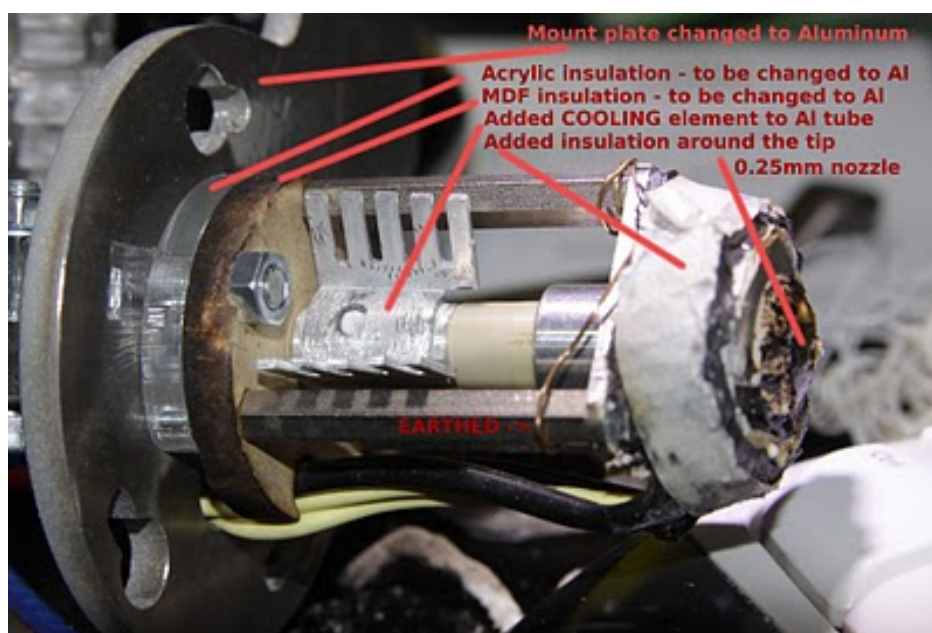

[Do you want to read more?](#)

ReplicatorG for RepRaps: Beta testers wanted

Wednesday, 8th December 2010 by D1plo1d

Over the past couple weeks Erik de Bruijn and I have been working on a new and improved RepRap 5D driver for ReplicatorG over on github and I think it's safe to say that it's ready for some serious testing. That is to say download it, burn it to zip disk (or whatever you kids are using these days) and give it to everyone you know.. oh and file bug reports! We need those.

Any 5d firmware should be compatible. So grab a copy at <https://github.com/Ultimaker/ReplicatorG> and try it out! (make sure to select *Mendel with Gen 3 Electronics* from the machine => Driver menu or add a configuration for your baud rate, etc. in machines.xml.dist and post your patch)

But wait, why should I use ReplicatorG you ask? Well if you've got a RepRap then ReplicatorG gives you a simple but powerful user interface to your 3d printer. It has manual control for your extruder, each axis, the heater and a heated build platform (if you have one). It also allows you to rotate, scale and auto-align your STLs before you generate GCode which comes in useful when you don't want to mess around with Blender to position each part. Finally it is integrated with skienforge and has some built-in settings for Mendels included to get you started (thanks Paul!).

What we're looking for now are beta testers to find the bugs we haven't found in testing it on our machines.

So heres the link: <https://github.com/Ultimaker/ReplicatorG>

Just click the download button. Once you have unzipped it on your computer you can use *ant run* from the command line from the folder you've unzipped it to in linux/windows/mac to automatically compile and run the ReplicatorG RepRap 5D Beta.

If you have any troubles compiling or running it check out the ReplicatorG help page on that:

<http://replicat.org/building-from-source>.

And remember to check for updates as we bug hunt.

update:

To everyone wondering, this is a vastly-improved update of the version in 0022.. I forgot to mention that crucial nugget, sorry for the confusion.

Linux users can use dist-linux.sh to compile an executable.

Ok, on to specific install problems:

Problem: *A warning message pops up saying machines.xml not found using machines.xml.dist instead.*

The .dist warning is expected and a result of using the *ant run* method, please ignore it.

Problem: *Mendel doesn't show up in the machines list*

Solution: To get mendel to show up in the machines list turn on experimental machines in file => preferences to get Mendel. If it still doesn't show up delete the .ReplicaorG folder in your home

directory and try enabling experimental machines again. If that doesn't work post a bug which brings me to..

Bug Reports can be posted at <https://github.com/Ultimaker/ReplicatorG/issues>

Thanks to everyone who commented on these! Next time I'll proof the instructions a bit more before posting so we don't end up with another screen of updates on all the critical things I completely missed ;)

Cheers,

Rob

[*D1plo1d*]

Reprappable Inkjet Head

Tuesday, 14th December 2010 by Adrian Bowyer

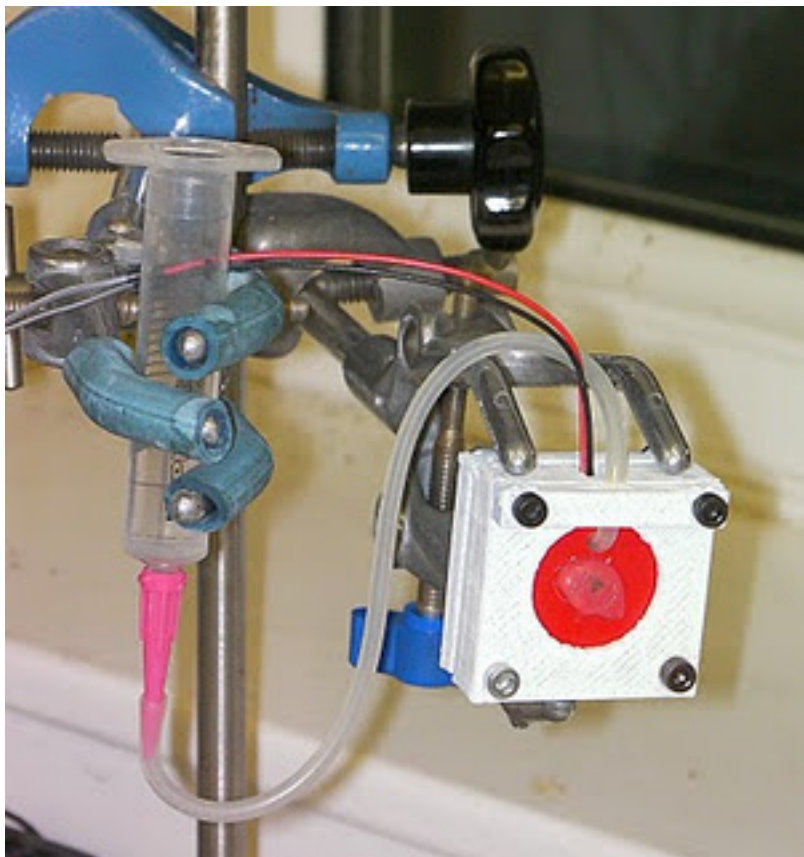

This is an inkjet head that is completely makable in a RepRap machine. It was inspired by [Johnrpm 's Scratchbuilt_Piezo_Printhead](#).

It has only three reprapped parts. The other parts are standard easily-obtainable items. There is no machining involved in making it - the only tools needed are scissors, a scalpel or razor blade, a hammer, a short piece of 3 mm steel rod to use as a punch, and a glue gun.

It uses a piezoelectric buzzer to drive the ink.

It is experimental, so it's reliability is not yet perfect... But it does work. Here's the video:

[Reprappable inkjet head](#) from [Adrian Bowyer](#) on [Vimeo](#).

I need to do more development on the driver electronics. Then I'll see if I can add heater elements so we can inkjet waxes and wood's metal...

Details are on the [RepRap Wiki](#) here.

ABS Multicolor Printing

Thursday, 16th December 2010 by D1plo1d

Chris Olah, a fellow RepRap hacker from Hacklab.to, has been experimenting with multi-colored prints on our Makerbot by loading differently colored ABS segments into the extruder. So far this has resulted in at least one extruder burn and a couple of really nice parts.

Full details in Chris's blog posts:

- [Multicolor 3d-Printing by filament swapping](#)
- [Fused ABS Filament](#)

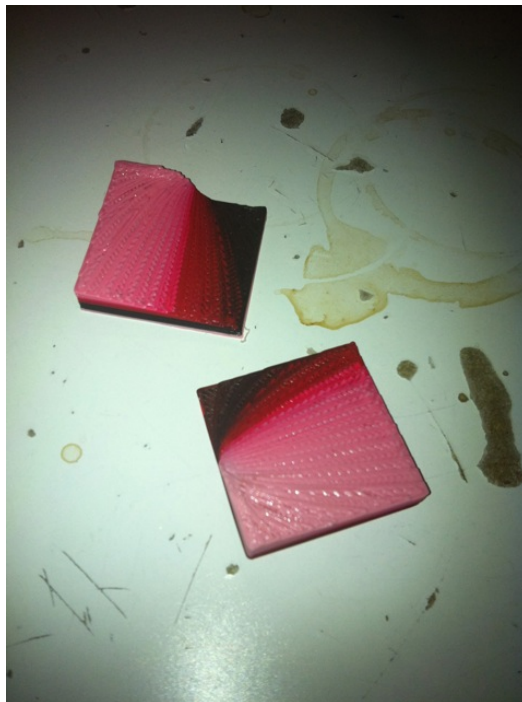

A proper conductive polymer mix?

Friday, 24th December 2010 by Forrest Higgs

In which your narrator begins to test a new conductive polymer mix.

One of the long term grails of the rewrap project is to be able to print circuitry. Currently, Rhys Jones, a PhD candidate working for Adrian Bowyer at the University of Bath, is devoting a lot of his time to addressing this issue.

Heretofore, we've looked at very low temperature eutectic alloys like Rose's and Wood's metal and confected methods of extruding it into preprinted channels. More recently, Rhys has demonstrated that ordinary solder can be successfully printed onto ABS.

We've looked at various concoctions of carbon, silver and other conductive materials with polymers at arm's length. Always, though, the conductivity of these mixes has been too low for them to be useful in printed circuits. Rhys, however, has looked at a two step process which may get us by that.

The main problem with printing PCBs with a rewrap machine is that PCBs are not that hard or expensive to have made using conventional, proved materials. This makes coming up with a method of printing them a bit tricky because it not only has to work, but it also has to yield a product that is not all that much difficult to use than conventional boards.

Recently, I ran across a high-tech company, Integral Technologies, located in Bellingham, Washington. They've come up with a different approach to creating a conductive polymer mix which uses conductive fibers mixed with conventional polymers. Probably the most exciting is their mix of very fine stainless steel fibres mixed with a blend of polycarbonate and ABS.

The volume resistivity for this material on the data sheet runs to 0.06 Ohm-meter. This is far too high for a useful conductive plastic. I rather shrugged the material off until I got a look at a few non-technical demonstrations of the material. This one shows two small bars of the material used to conduct 110 v current running an electric drill.

Interestingly, Bill quoted me a price range of between \$9-45/lb depending on the composition. More interestingly, the PC/ABS mixes which resemble what we are already used to using in Reprints are at the cheap end of the price spectrum.

As well, they demonstrate measured resistance across an extruded plate of their material using an analog multimeter.

There was obviously a mismatch between what their data sheets said and what the non-tech demos indicated. I explored this question with Bill Robinson at Integral. It boils down to the "skinning effect" mentioned in the first clip. Simply explained, it means that the metal fiber doesn't tend to show up at the surface of an extrusion. This means that the material is partially insulated at the surface of an extruded surface.

That left the issue of how, in the second demo clip, ordinary multimeter probes registered effectively zero resistance when measuring resistance across a extruded plate of their plastic. Bill sent me some demo plates of the material a few days ago. I have a digital multimeter rather than the analog Radio Shack multimeter.



Multimeters are not particularly good at accurately measuring low resistances. Anything reading below about 5 ohms for most multimeters is not something you want to bet your life on.

I tried duplicating the measurements in the clip and kept running into skinning effects. In places I could get readings less than 1 ohm, but others I would be in the mega ohm range. I made a cut across one end of one of the samples. You could barely see the fiber ends. Integral is using VERY fine fibres.

I then drilled 1.5 mm holes through the plaques and put the probes through those. I was able to get more consistent and lower resistance measurements. Mechanical contact between the probes and the fibre ends is how good conductivity is achieved.



The best I was able to get consistently was 0.6-0.8 ohms over about 100 mm of the material. Bill at Integral suggested that if we used a 0.5 - 1.0 mm extrusion nozzle we ought to be able to avoid jamming of our extrusion nozzle with the stainless steel fibres. Making strip extrusion as we can with a Reprap printer should tend to align the fibres much better than a simple injection moulding would do. The problem as I see it will be making a conductive connection between two traces and

making a connection between a trace and a component.

The question now is whether what we know about this material now justifies having a sample turned into fibre for further testing.

Pretty outside, ugly inside

Sunday, 26th December 2010 by prusajr

I think we are now at phase, where easiest improvement of quality can be made by tweaking settings and software. So I did. I've done little hack to Skeinforge 37, so it can now generate perimeter (outside) at better resolution than infill. Dont get it wrong, we were able to print at the better resolution before too, but it took ages to print the object.

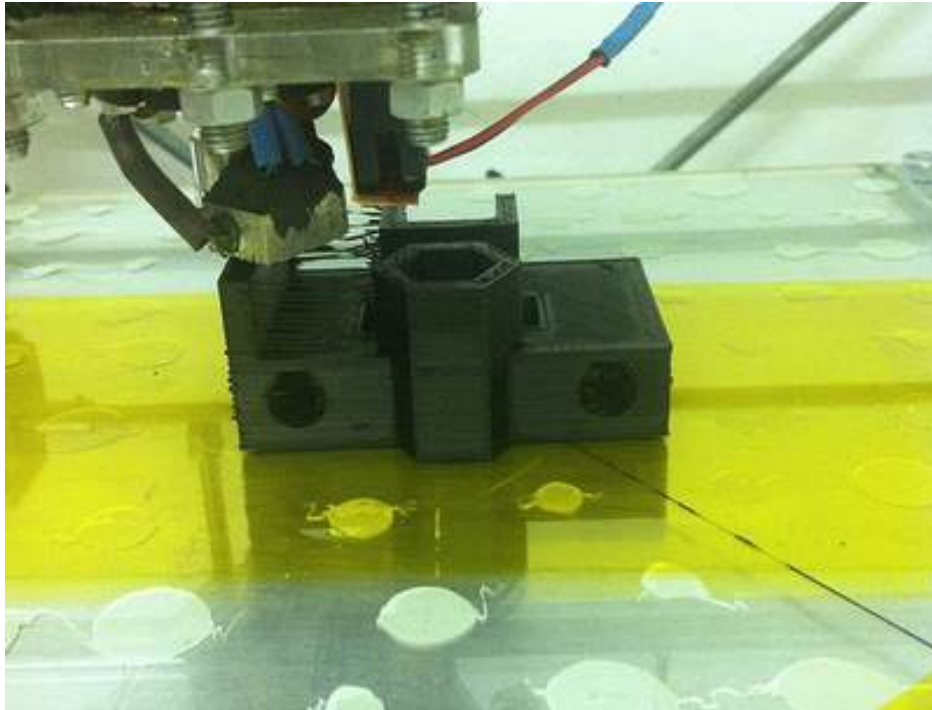

For now I tried printing infill at 0.4 and perimeter at 0.2 since I don't have my tweaked mendel here and only not very good printer which name will remain unspoken :-). I cant wait to be on my Mendel with 0.35 nozzle and 0.1 perimeter layers and 0.3 infill, aka printed porn :-)

Some data:

Print time of object at 0.4: 106min (100%)

Print time of object at 0.2perimeter 0.4infill: 144min (135%)

Print time of object at 0.2: 244min (230%)

On the other hand you have same quality object as from full 0.2 in just 59% of time :-)

If you want to try it, heres the hacked Skeinforge

http://dl.dropbox.com/u/8967423/37_reprap_python_beanshell.zip Its not easy to set it right now. It's still hacking, don't forget it. But I have few hints: Set carve at 0.2mm layers if infill should be 0.4. Counted line width has to be same as for 0.4 so set Width over thickness variable accordingly to it (just mutliply by two) and set perimeter flow rate to half. That should be good starting point!!

I even uploaded my skeinforge settings here <http://dl.dropbox.com/u/8967423/settings.zip> so you can look it up. Original setting is Test RapMan04 and hacked one is RapMan04. BTW you can sneak peek my settings for other printers ;-)

Remmember this is not fool-proof, please share ideas under, what to be aware of etc. so Enrique can take it and all implement in official Skeinforge :-)

First tweak: last one 0.4 infill layer replace with 2x 0.2infill layers to smoother finish :-)

Belt drivn extruder

Sunday, 2nd January 2011 by Buzz

It occurred to me recently, after building two mendels, and printing way too much (including one of those mendels), that the weakest harware point in my Mendel was the gearing on my extruder/s.

They always seem to have problems.

I have problems with:

- *printing the teeth nicely/accurately,
- * getting the teeth to mesh,
- * keeping them meshed over time,
- * teeth wearing out or getting "chewed off"

and the resulting printing issues these cause!

So, I thought "I don't have issues with the XYZ axes anymore, so why not use the same principle/s on the "E" axis.?"

Result: A belt driven "adrians" extruder.

I took a random "big" cog for a belt, and a semi-random "small" one (ie matching), and put them on one of my extruder/s. It's awesome! I haven't "skipped" , or chewed a tooth or anything in ages!. It was a little fiddly sewing the belt together (with a needle and thread), but that's just because I'm too cheap to buy one the right size.



From Reprap

and a youtube link to it printing:

<http://www.youtube.com/watch?v=SVeMdm50avY>

Evolving the Prusa Mendel: Part 1

Sunday, 9th January 2011 by D1plo1d

Chris Olah and I have been developing a fork of the Prusa Mendel at Hacklab.to over the past couple months with 3 major goals:

- 1) get larger build volumes from a smaller printer footprint [we don't have much room at hacklab]
- 2) reduce the printed and non-printed part counts
- 3) increase the configurability of the Prusa Mendel

Today we are able to show the first parts of the Hacklab RepRap - a simpler, smaller and more configurable Prusa Mendel. I'll leave the in-depth discussion to Chris but heres a couple pics to wet your appetite:





Full details in Chris's post..

The Emerging Economy of Home Manufacturing

Monday, 10th January 2011 by Adrian Bowyer

Hod Lipson and Melba Kurman were asked by the White House to write a report on the emerging phenomenon of home manufacturing. It has recently been published and - as you would expect - it makes interesting reading. You can access it here:

<http://www.mae.cornell.edu/lipson/FactoryAtHome.pdf>

RepRap MicroExtruder

Thursday, 13th January 2011 by Adrian Bowyer

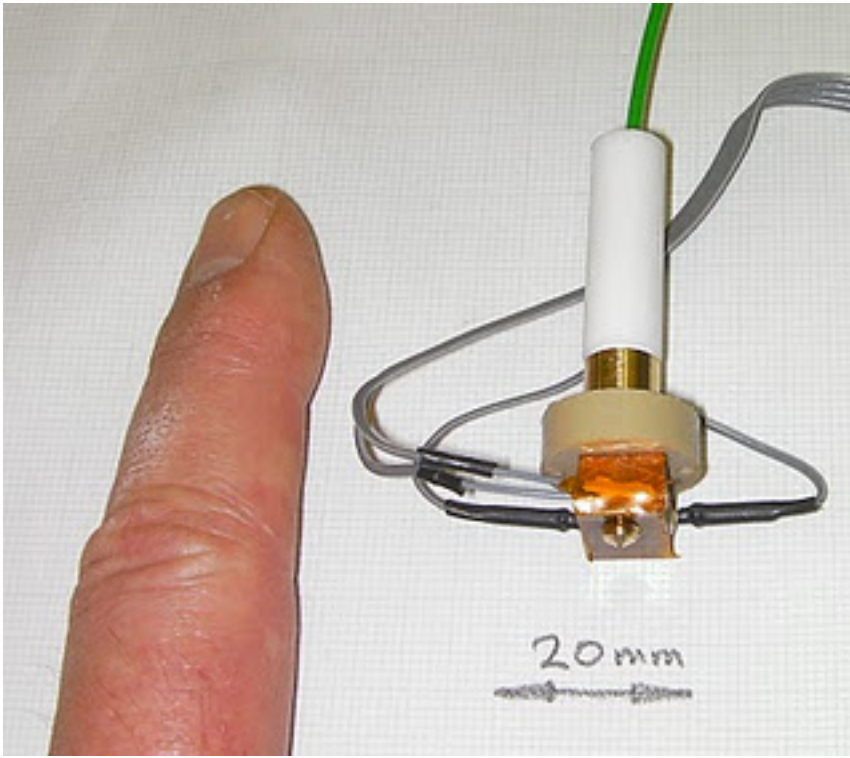

I have started to design a MicroExtruder for 1.8mm filament. So far I have just got the non-reprapped parts, shown above.

As you can see, it is about the size of the two end joints of my index finger.

It is a miniaturised version of my standard extruder here, which was based on ideas from Nophead and others, with bits from me.

From the top there is the filament (green - thanks Vik!) then a length of 8mm diameter PTFE. This screws into the brass nozzle with an M6 thread. There is then a PEEK disc with two 2mm holes either side. Those will take two M2-threaded rods. The tension in these will resist the extrude pressure.

The brass nozzle is threaded M4, and screws into a small brass heater block. This takes the normal RepRap thermistor for temperature measurement, and is heated by an 8.2 ohm metal-film resistor rated up to 235 °C, which should give 16 watts at 12 volts.

The filament hole down the PTFE and brass is 2mm in diameter.

So far it is untested - watch this space...

Filling in with the fillings

Monday, 24th January 2011 by Vik Olliver

I've recently been experimenting with the loading of various fibres into CAPA and PLA. This started out as simple strengthening for the 3mm PLA that I sell, but the addition of 20 micron x 1mm nickel fibres makes it conductive. Dunno how useful this will be yet but it certainly allows RFI shields to be printed.

Then I hit on a brainwave: short polyacrylonitrile fibres. There are normally used to reinforce synthetic rubber. But they have another use: The feedstock for carbon fibre.

My trick is to mix polyacrylonitrile and similar materials in with PLA or CAPA. This is then turned into filament, which in turn is printed into an object on a RepRap - this tends to align the fibres.

The object is then encased in a ceramic and heated to the vapourisation point of the PLA or CAPA. You then have a ceramic mould stuffed with oriented polyacrylonitrile. Introduce an inert atmosphere and raise the temperature and you have a mould full of carbon fibre. This can be surface-activated in the usual ways, or coated with vapour deposition before being vacuum-encased in epoxy to form a complex, 3D carbon fibre composite object.

Yes, I am looking for sponsorship :)

Vik :v)

Evolving the Prusa Mendel: Part 2

Monday, 24th January 2011 by Christopher Olah

Two weeks ago, Rob posted about some of the awesome stuff we've been doing with the Hacklab Reprap, a Prusa fork. I thought it might be worth while to bring everyone up to speed on what has happened since.

Summary:

1. A ground up redesign of z-motor-mount. It reduces the build time from 1 hour and 20 minutes to 30 minutes. It reduces the part count by two and gets rid of one rod.
2. New designs of y-end-* reduce part count and build time.
3. 3d printed nuts. You can also watch a [video of them](#).
4. Pics of y-end-* designed for threaded rod instead of belts, though this feature is in hiatus for now.
5. There is now a mailing list for [hacklab-reprap](#).

[Read More](#)

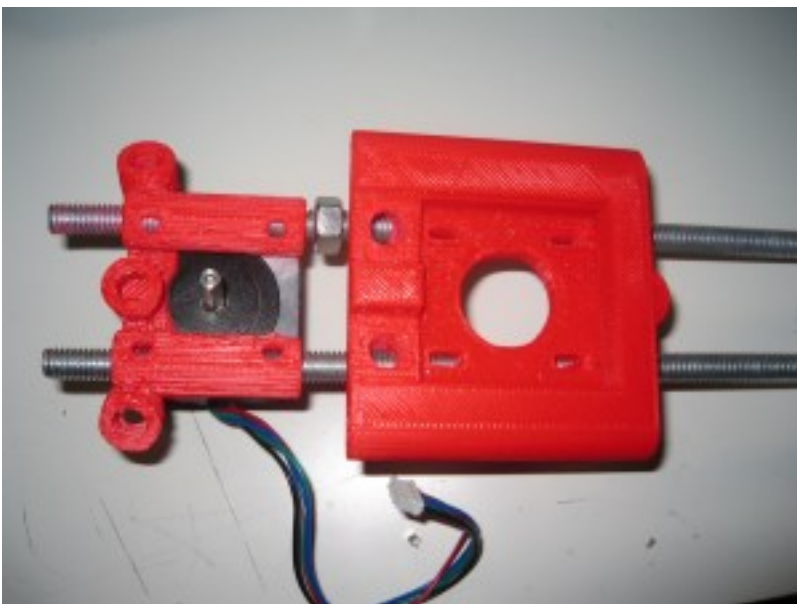



Conductive pastes take 453

Wednesday, 26th January 2011 by Rhys Jones

As ever, I'm constantly on the look out for nice conducting materials. I recently stumbled across a special powdered Nickel. What's particularly interesting about it is that it is dendritic i.e. the particles are spiky rather than spherical. Essentially this means that when mixed with a polymer, the metal particles are more likely to touch each other so it therefore gives a much lower resistance.

Apparently this stuff is typically used making conductive paints, so its readily available. I managed to get some filamentary powder thats about 2.35um in cross section and 15um long . In small quantities this costs about £95/kg

A colleague and I crudely made a thin film that measures 100x100x1mm out of this powder mixed with liquid latex in a 1:1 ratio in terms of weight. The paste seemed sufficiently viscous that we could extrude it with a paste extruder. We embedded 9 electrodes in the film so that we could get repeatable readings. The total resistance between opposite electrodes came in at 0.8ohms, which is about a 9cm length spanning the film. I guess this is sufficiently low to be useful for a lot of low current applications.

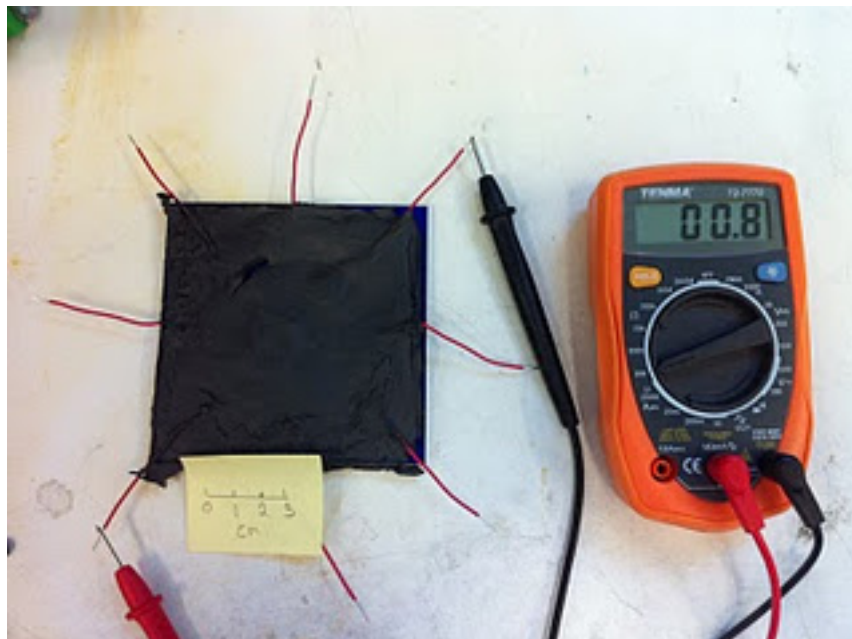

Improved Huxley design

Thursday, 27th January 2011 by Adrian Bowyer



I am working on an improved Huxley design. This is slower than I'd like, owing to lack of time, but it's coming together.

A few key points:

1. It's all being done in OpenSCAD - the files are in the RepRap svn repository under huxley.
2. It uses printed sliding bearings that are screw adjustable, so they always fit exactly. Further, you can compensate for wear.
3. Other adjustments are done with shims. Or small rectangles of paper...
4. Rhys has found a very high torque NEMA 11 motor which I hope to use for my microextruder for it.
5. I'm trying to design it for ease of assembly. In particular, I'm trying to get it so that you can put things together in just about any order, and so that you don't have to take four things off to extract and replace a fifth.

The first version will have a moving Y platform, like Mendel. But MakerBot have taken Ed Sells' idea of building on a conveyor belt and made it work, so I think replacing the Y motion with a belt will follow soon after.

RepRap Calculator

Saturday, 5th February 2011 by prusajr

I recently started to do simple tool for RepRap related calculations. Mainly because often someone ask me how to count something on IRC, now I can link them to this tool. It's simple page with calculations via Javascript, so its runs in your browser even if you are offline.

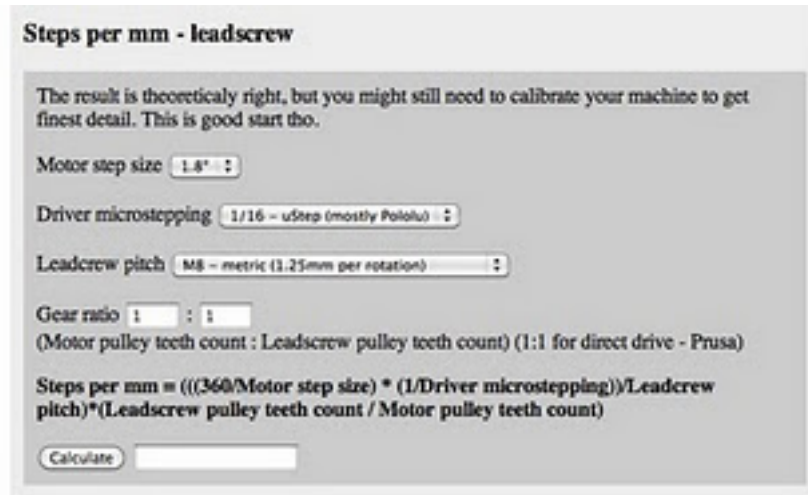

Steps per mm - leadscrew

The result is theoretically right, but you might still need to calibrate your machine to get finest detail. This is good start tho.

Motor step size

Driver microstepping

Leadcrew pitch

Gear ratio :
(Motor pulley teeth count : Leadscrew pulley teeth count) (1:1 for direct drive - Prusa)

Steps per mm = $((360/\text{Motor step size}) * (1/\text{Driver microstepping})) / \text{Leadcrew pitch} * (\text{Leadscrew pulley teeth count} / \text{Motor pulley teeth count})$

The calculator is here <http://josefprusa.cz/RepRapCalculator.html> or on Github <https://github.com/prusajr/RepRapCalculator>.

So far It can count these few things, but if you have idea what more it can do lemme know in comments

- Motor stuff
- Precise calibration
- Steps per mm - leadscrew
- Steps per mm - belt
- Convertors
- mm/s to feedrate
- Feedrate to mm/6
- Extrusion
- Flow rate multiplier for layer height change

Thermocouple vs Thermistor

Saturday, 5th February 2011 by prusajr

I originally wanted to just calibrate the thermistor table I used in my FW, since I remember that Camiel from Mendel-parts was moaning that his table was horrible and it affected his prints, I now just guess that his table wasn't made for his thermistor. I used one generated exactly for my thermistor by `createTemperatureLookup.py` from SVN. So I crated fake heater with both Thermocouple and Thermistor and written small sketch in Arduino to generate table, BUT I did want first to simply try how imprecise it is. Then I was shocked, both readings were pretty close, actually biggest deviation was 3°C. You can see the graphs under and also download the Arduino sketch and sample data.

My verdict, is that both technologies are good for heaters and heatbeds, the precision is mainly affected by mounting on heater. Also be careful to use precision resistors for thermistor circuits, thats all :-)

Code and data can be downloaded on [RepRap wiki](#).

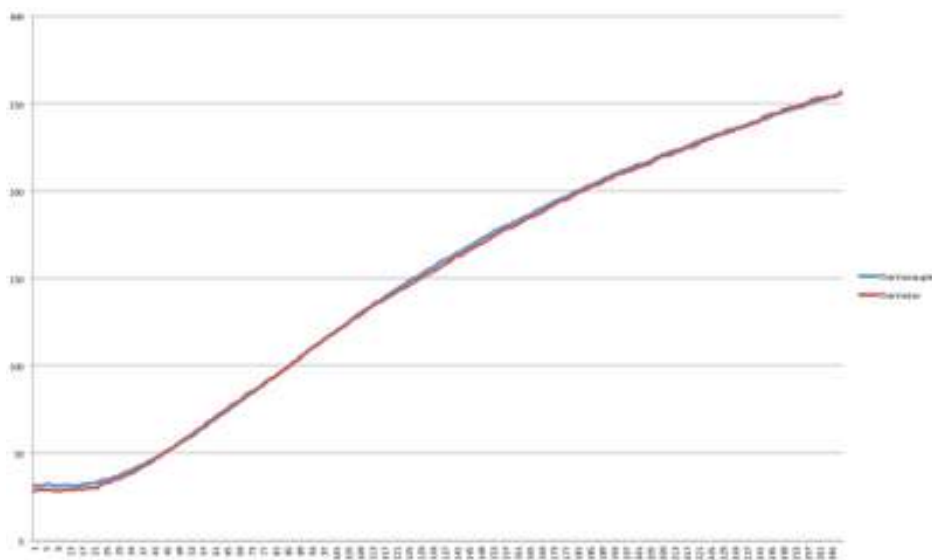

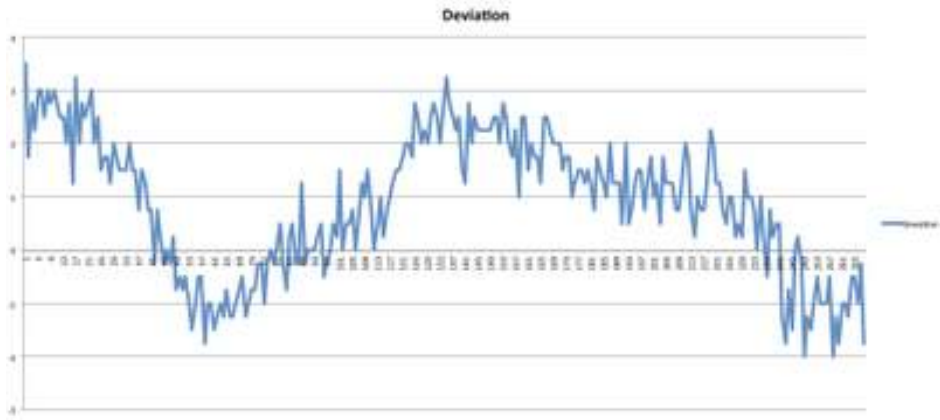

Printing small holes in small features

Monday, 14th February 2011 by Forrest Higgs

In which your narrator discovers an out-of-the-box method of making small holes for pinned hinges in small features.

Recently, Chris Palmer blogged an [exquisite article](#) on the pitfalls of getting the diameters right in holes made in objects. It related very closely to a problem I was having in developing a printed robot hand.

Previously, I'd had no trouble in that the joints between the phalanges of the robotic fingers were very large and printed.



I loved this approach, but sadly had to abandon it simply because the large contact areas between the phalanges created excessive friction and because the number of things that I needed to have happening in a phalange made the large joints unhelpful. The need for smaller, more compact hinged joints brought to mind the work of Frank Davies with his [Sarrus Linkage positioning system](#).

Frank used pinned hinges to great effect.



As I was designing such pinned hinges into my phalanges, I soon discovered that the substantial pins that Frank was able to use were too large for the delicate phalanges that I was working on. In fact, I finally settled on using simple paper clips (0.84 mm diameter) for the pins in my work.

In designing the joints, I followed the usual Reprap gambit and simply included the pin holes in the STLs for the parts.

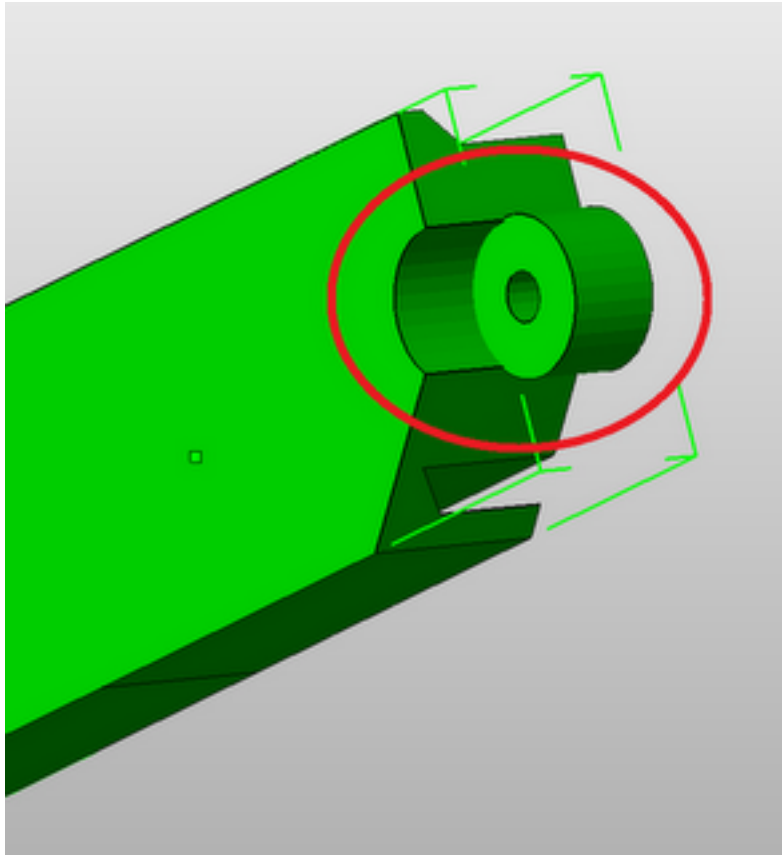

The only problem with this approach was that both the hole and the hinge joint that it was seated in were very small. The joint had a radius of only 3 mm and the hole 0.42 mm.

Ordinarily Reprappers use a few print paths around the perimeter and then infill the rest. I design using thin walled parts glued together after printing, an approach that lets me create fine featured parts that are fast to print. With a feature this small, however, print roads radiating out from the pin hole very quickly clash with print roads radiating in from the joint.

It's bad design practice to let a hot print head hover for extended periods of time over or near a small feature. You want the head doing the feature then going far away quickly so that the molten plastic thread has a chance to cool a bit before the next layer is applied. If you don't get this your small feature becomes a featureless blob.

Print road clashing between the pin hole and outer perimeter of the hinge had me fiddling around with print road width for the better part of a week with indifferent results. Yesterday, however, an out-of-the-box solution to the problem finally hit me. I'd do better at printing the pin hole if I simply didn't include it in the STL, something like this.

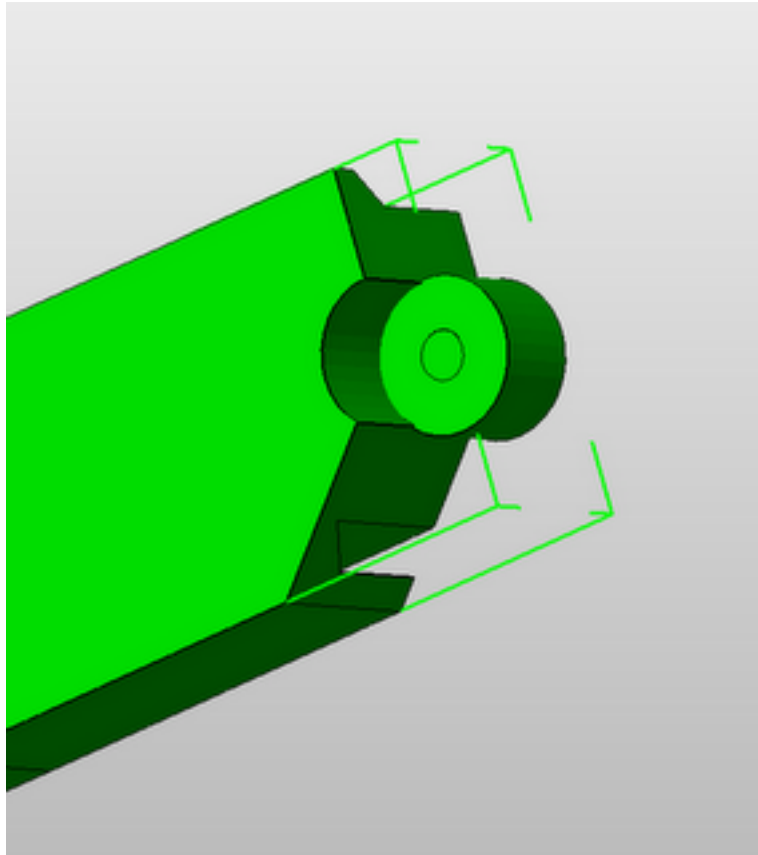

Basically, I just plugged the hole. What that did is to limit the print road propagation to those radiating inwards from the outside perimeter of the hinge. Since I don't use infill because of the problems getting the perimeter roads to match with the infill roads, for the first few millimeters of the print had no hole due to the use of perimeter roads to completely fill the layer.

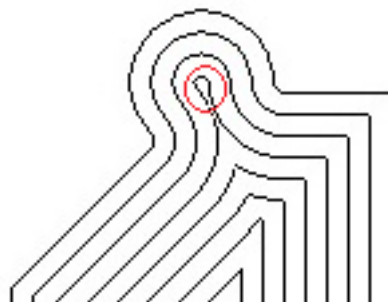

Once I had the roads calculated I pulled up the .PNG images for the completely filled layers. You can see the bit that will fill the pin hole circled in red.



It was a simple matter to pull the images into Paint and remove the inconvenient loop from the images and then continue processing the images into Gcode.

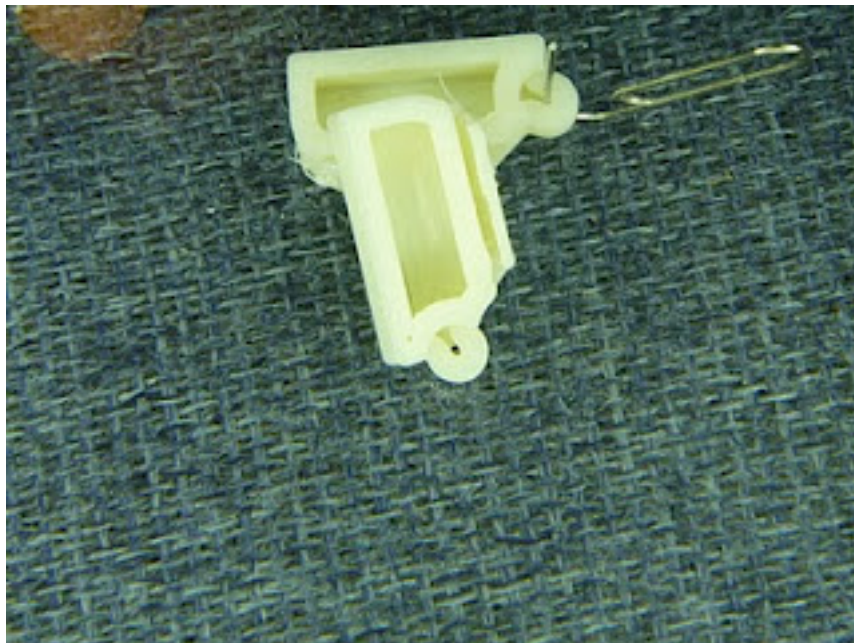

By calculating the width of the print roads appropriately, I was able to get the proper diameter for the pin correct on the first try.

The annoying part of this whole epiphany was that it took me over a week and dozens of trial prints to see the simple way of solving the problem.

Going for 32 bit embedded processors

Tuesday, 1st March 2011 by Forrest Higgs

In which your narrator begins to cobble a next-generation Reprap controller board together out of much bigger vitamins than has previously been possible.

The controller for the Bits from Bytes Rapman has long been the most sophisticated in the world of Reprap printers. It's use of the PIC32 MCU gives it the power to do things, like support an LCD display, SD cards and 0.1 mm gcode steps without difficulty are very difficult to do with 8 bit MCUs. There are two barriers to it's widespread adoption in Reprap printers, however.

The first is that PIC32s typically come as 100 pin surface mount chips. That means that you have to do some fairly sophisticated PCB design and get the damned chip soldered on properly. That's not impossible, but it's not easy, either.

The big barrier, however, has been the lack of inexpensive compilers for PIC32s. The one from Microchip is very good, but costs over \$1K. Recently, that situation has been remedied by a Serbian firm, Mikroelektronika. I had had experience with their PIC 18F compiler and found it both very reliable and possessed of an enormous library of library functions which made it extremely valuable as a development tool.

Thus, when I heard last year that Mikroelektronika had undertaken to create an inexpensive compiler for PIC32 chips I was immediately interested. After a long development and beta cycle they did their formal release this morning. They offer inexpensive C, Basic and Pascal compilers for the PIC32.

Some time ago, I resolved to build up my next printer rather than buy another BfB product. The ultra-reliable BfB extruder and controller board were two technologies that I intended to bring across. I wanted, however, to have two extruders and a somewhat bigger print table to accommodate them better than Rapman allows.

Laszlo created an inexpensive, easier to repair hot end than BfB offers which I also intend to use in the design.



As well, recent purchase of a hobby lathe ...



... will let me experiment with large diameter precision lead screws which can double as structural elements should cut down on the amount of steel in the printer rather dramatically.

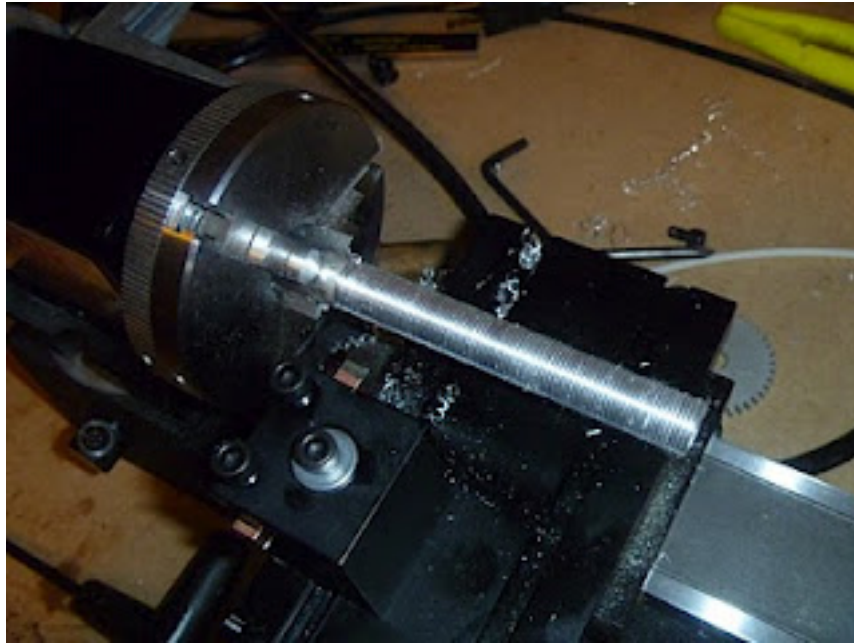

The big advantage to the new Mikroelektronika compilers, however, is that they also offer an inexpensive line of prototyping boards. That will save me the development time of putting together a new board with technology that I am not familiar with. I ordered their most expensive board {\$169}...



Image not found.

which includes everything that I need save stepper drivers. I also ordered one of their stepper driver boards. to test with it to test my firmware with ...



before I integrate the heavier amperage Pololu driver board that has been used in a number of other Reprap controller boards.



The current situation is so much better than we faced when we began the Reprap project in 2005. Then you were pretty much doomed to building up boards from scratch. These days you can buy inexpensive boards and add-on miniboards to build up an inexpensive yet very sophisticated Reprap controller board quite easily.

Should my controller design catch on, I suspect that other Reprappers would want to use this much smaller and less expensive graphics board in Mikroelektronika's stable ...



Image not found.

... which has pretty much everything the larger board does.



Image not found.

Printing People

Wednesday, 2nd March 2011 by Adrian Bowyer



Fabricate Yourself is a project that documented the Tangible, Embedded and Embodied Interaction Conference. They used a kinect to capture 3D scans of lots of people then printed them all in miniature.

How cool is that?

RepRap Universal Mini Extruder

Thursday, 3rd March 2011 by Adrian Bowyer



I have been designing a new printable extruder. It is primarily intended to be small and light enough to mount directly on Huxley, but it should work on virtually any RepRap or similar 3D printer.

It features:

1. 1.75 mm filament
2. Adaptable mounting plate to attach it to virtually any 3D printer
3. Very compact high-torque NEMA 11 motor
4. Wade-style hobbed bolt filament transport
5. Wing-nut drive to spread the torque loading on the plastic gears
6. Push-fit hot-end parts - no thread cutting
7. Lightweight: 335g (about half the weight of the usual Mendel extruder)
8. Compact design (74 mm x 83 mm x 100 mm)

Here's a video of it working:

[RepRap Universal Mini Extruder](#) from [Adrian Bowyer](#) on [Vimeo](#).

Documentation and full details being [written up here](#)...

First Dutch Reprap Build-Party

Friday, 4th March 2011 by Adrian Bowyer

Just in case you haven't caught it elsewhere, there's a brilliant video of the first Dutch Reprap Build Party on YouTube:

Thanks to Ruben Lubbes and all at IkMaak.nl for organizing this amazing event.

They plan more...

High-Impact PLA

Friday, 4th March 2011 by Vik Olliver

One of the problems with PLA is that it shatters when stressed, rather than bending gracefully. This problem is solved in ABS by adding impact modifiers - basically synthetic rubber blends - to give some flexibility under stress. Luckily, I found an impact modifier that is compatible with PLA and does not significantly alter the melting point. At about 1/3 it makes PLA this flexible without fracturing:

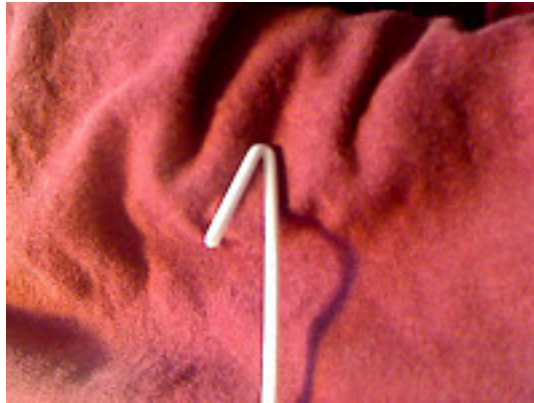

I've got to run a few more printing tests on it, but it's looking promising as a material that offers the durability of ABS with the reduced environmental footprint and ease of extrusion of PLA. Oh, I suppose I'd better figure out what it'll cost me too :)

Update: I flexed some back & forth 100+ times and got bored trying to break it.

Printing with it is much trickier than plain PLA. It wants to coalesce into one lump, and you really need cooling between layers.

Vik :v)

High Impact Test

Saturday, 5th March 2011 by Vik Olliver

I've been printing little green targets from PLA and white(ish) ones from IMPLA. The IMPLA needs an extra 10C heating, layers thinner than 0.4 and inter-layer cooling. In other words it is no fun to print with.

So, frustrated I took the whole lot outside, lined them up against the wall:

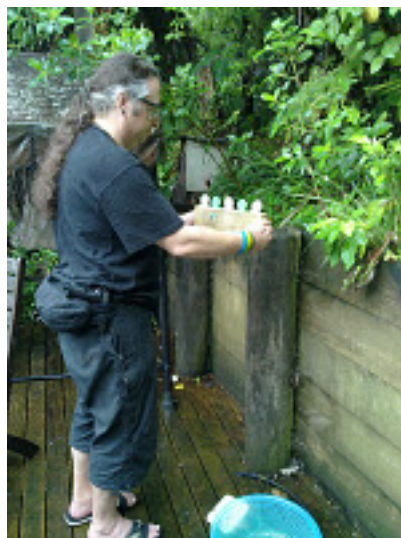

and shot them:



You can see in the aftermath, both green PLA targets have chunks missing from them. One white IMPLA target is split but holding together. The 3 BBs embedded in the wood on the left show the level of impact.



Useful stuff, but I'm not sure if it's worth offering for sale as it is so tricky to print with.

Vik :v)

3D Printed Adult's Bicycle

Monday, 7th March 2011 by Vik Olliver



Lifted from a Eureka Magazine Article. "The 'Airbike' is made of nylon but, according to EADS, is strong enough to replace steel or aluminium and requires no conventional maintenance or assembly. It is 'grown' from powder, allowing complete sections to be built as one piece; the wheels, bearings and axle being incorporated within the 'growing' process and built at the same time. Because it can be built to rider specification, it requires no adjustment."

Vik :v)

Impartial reivew of the Clonedel Cast parts by Metrix

Create Space

Tuesday, 8th March 2011 by Neil Underwood

Open3DP was nice enough to send me some of the cast parts being sold by Metrix Create Space. I wanted to see the part quality in person, and to give them a impartial look.

I have seen the Techzone Lasercut wooden Mendel, the CNC milled Issac Mendel, and wanted to see if these cast parts where usable. I was very surprised at how strong they where and the their quality.

To use them you will need a drill press, and the parts are a bit weaker than ABS, but I think they seem usable.

Below is a video of a Mendel assembled with these parts printing a cube.

That's one of the issues with disruptive technology like RepRap, every time you think you have a handle on how things are going, it surprises you.

18 Months ago the plastic parts for a Mendel where going for \$700+, 12 Months ago the price settled down to \$250-\$400, 3 Months Ago Prusa Mendel dropped the price for the RP parts to \$125-\$150. Now the Clonedel cast RP parts are going for \$50 (I personally know of 3 shops gearing up to start selling them).

I wrote a blog post over at my personal Blog a few weeks ago describing how to put a Prusa Mendel together if you don't have access to a 3d printer for around \$510, I guess I need to update it to \$410 now. Amazing times.

Development board arrived

Thursday, 10th March 2011 by Forrest Higgs

My PIC32 development board arrived today!

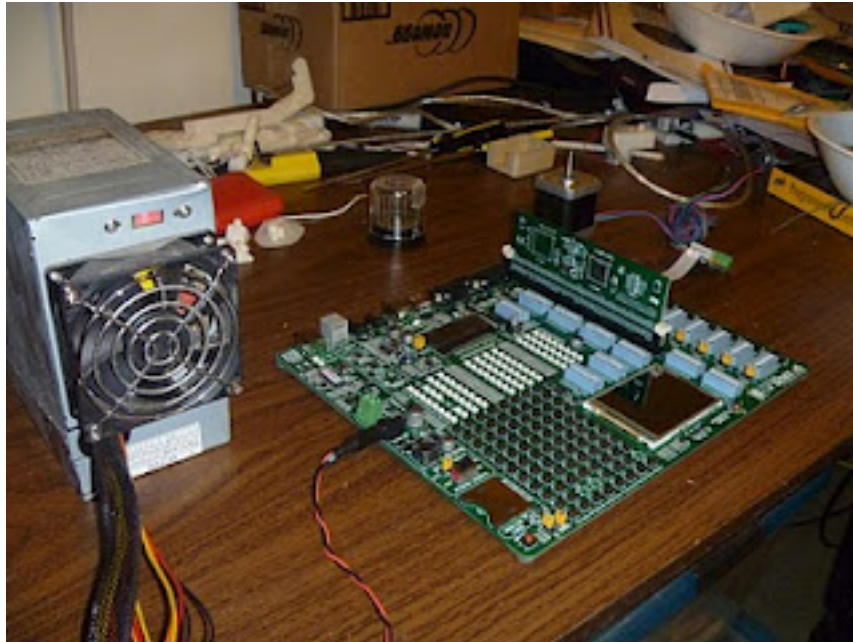

I also got a trial stepper motor controller with it.



The development board looks as good in my hands as it did in the sales literature. My old PC power supply even had a power connector that fit with the board already installed. It is a relict of a battery charger for an old Sony digital camera that I finally retired last year. I am also wanting to adopt Rapman's use of milled linear guides and linear bearings. If you look hard these are not all that expensive. For bearings, I found this little unit...



12mm Linear Motion Bearing/Bushing LB12UU

Code: **Kit12098**

Price: **\$3.95**

[add one to basket](#)

★★★★☆ (1 review)

To be well within budget. Guide shafts are a little pricier. In the US it appears that 12 mm shafting is the least expensive while still being stiff enough for a printer. Most pricing seems to be running around \$0.50/inch. That's not cheap, but not impossible.

Being a Scots-Irish tightwad, however, I kept looking for a better deal and ran across this...

Compare / Select Item



**60 Plus Metric Linear Shafting -
12mm Dia. Shaft**
Item #: T9FB393287

Our Price: \$0.80

Qty: [Add to Cart](#)

[See all 9 items in product family](#) 

...which comes in at a bit under \$0.07/inch. I spoke with the vendor today and they are checking to make sure that it meets CNC requirements for a linear guide. The general impression was that it did, but I want to be sure.

If that price does follow, it should be possible to replace the effective, but overcomplicated z-axis arrangement of Rapman which derives from the old Darwin design...



...which has 8 mm guide rod and a plastic bushing with a 12 mm guide rod and a proper linear bearing. That extra rigidity might allow me to control the position of the print table with an single, proper lead screw attached to a cantilever beam which contacts the bottom of the print table in the center instead of three or four lead screws, or cheap studding {threaded rods}, more likely. Certainly the leveraging the guide rods as vertical structural members should simplify the design a bit.

Best of the RepRap Wiki 3/11/11

Friday, 11th March 2011 by Neil Underwood

The RepRap Wiki is a great tool to host your project, but for too long we have allowed some of these great updates to the Wiki to go unsung. From here forward I will be doing a weekly recap of the new content of interest to me in the wiki. Remember these call outs are based around the things I found interesting, if you feel I overlooked your update in error, please speak up in the RepRap user email list, and I will try to add you to the blog next week.

Now for updates of note this week in our Wiki:

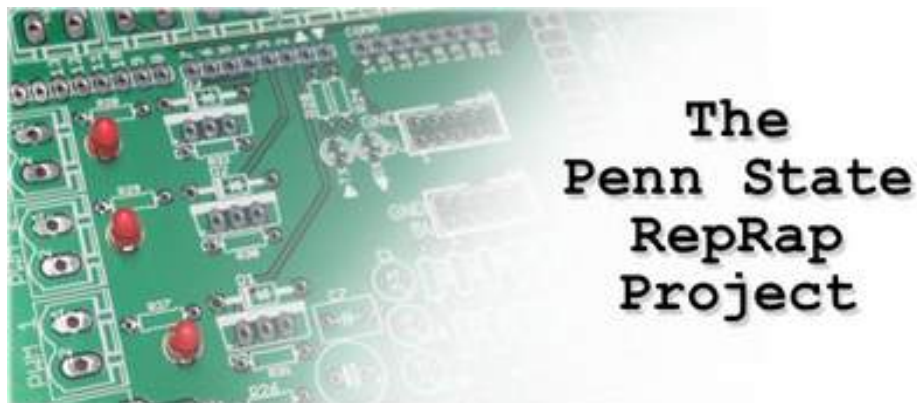

The Penn State RepRap Project

They have been doing wonderful updates for each of their machines, and some of the most detailed build logs for the Laser Cut Mendel that I have seen to date. Go over there and check out their 4 Mendels, 1 Huxley, and 1 Fab@Home.

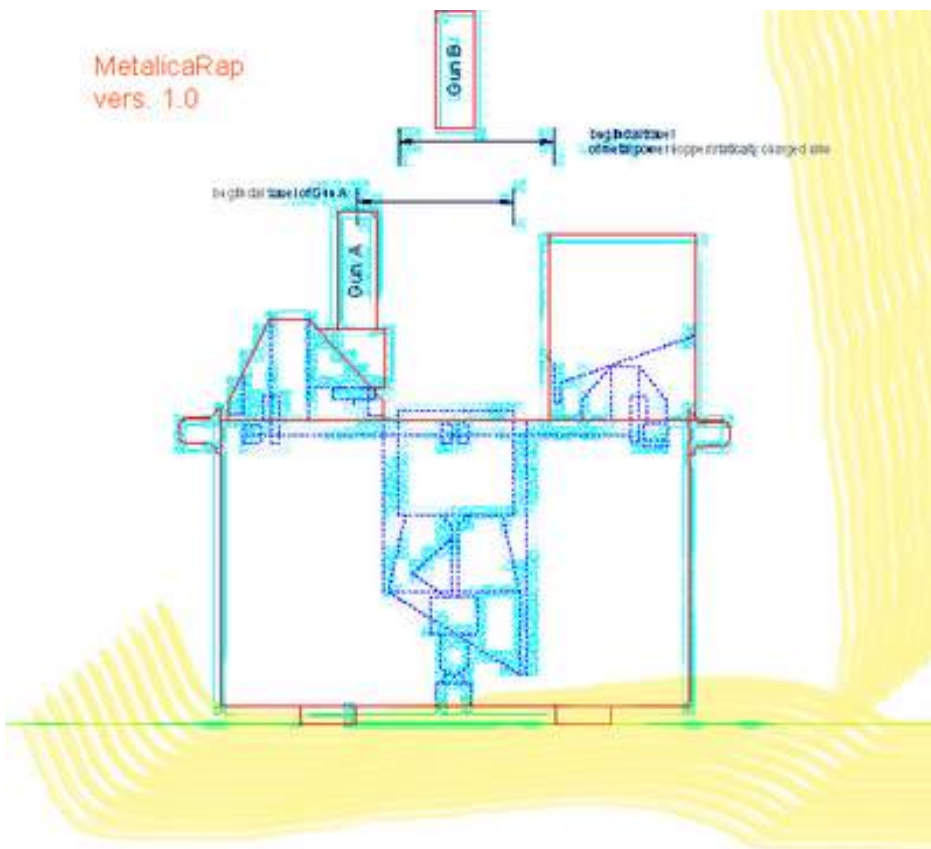

MetalicRap 1.0

Rapatan is an almost feverish updater of the wiki on his MetalicRap project. In the last week he has added a huge amount of content to his already prolific documentation on the wiki, and has started to reach out to the community for help in MetalicRap's development. I even saw Prometious Fusion has joined his team. Awesome work guys!



A5Powder Bed Printer

Johnrpm has been doing a lot of design work, and real hardware work on his powder bed printer. I am a sucker for pictures of real world hardware, especially when it is this awesome!

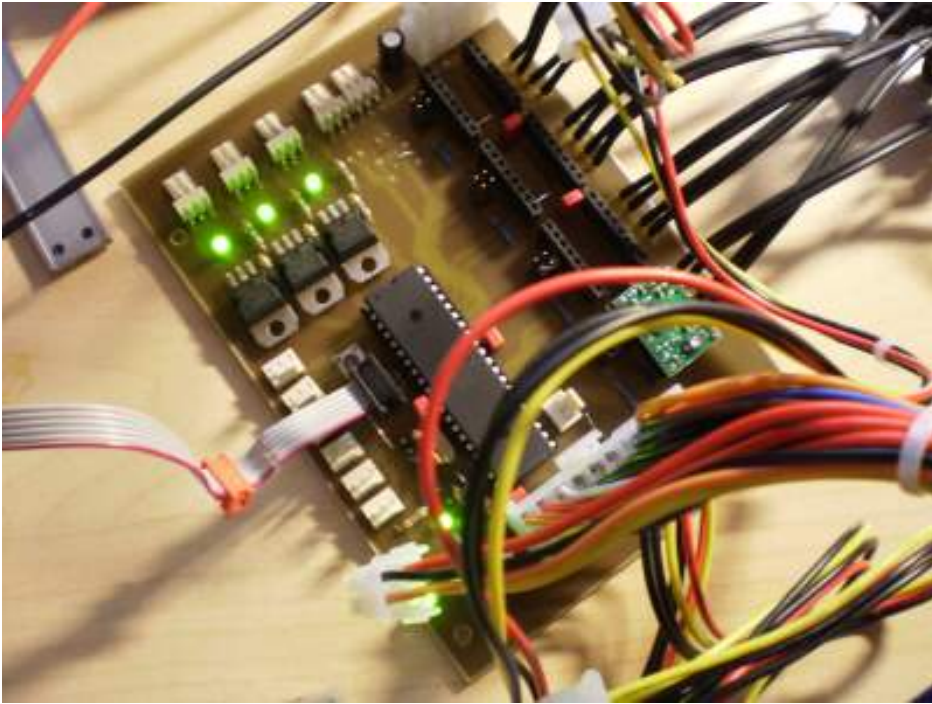

Gen 7 Electronics

Traumflug has really been putting some work into his Gen 7 electronics in the last week. He now has 4 different Mendels running off his boards. For those that have not been following this development is a hybrid of RAMPS and Gen2 on a board.

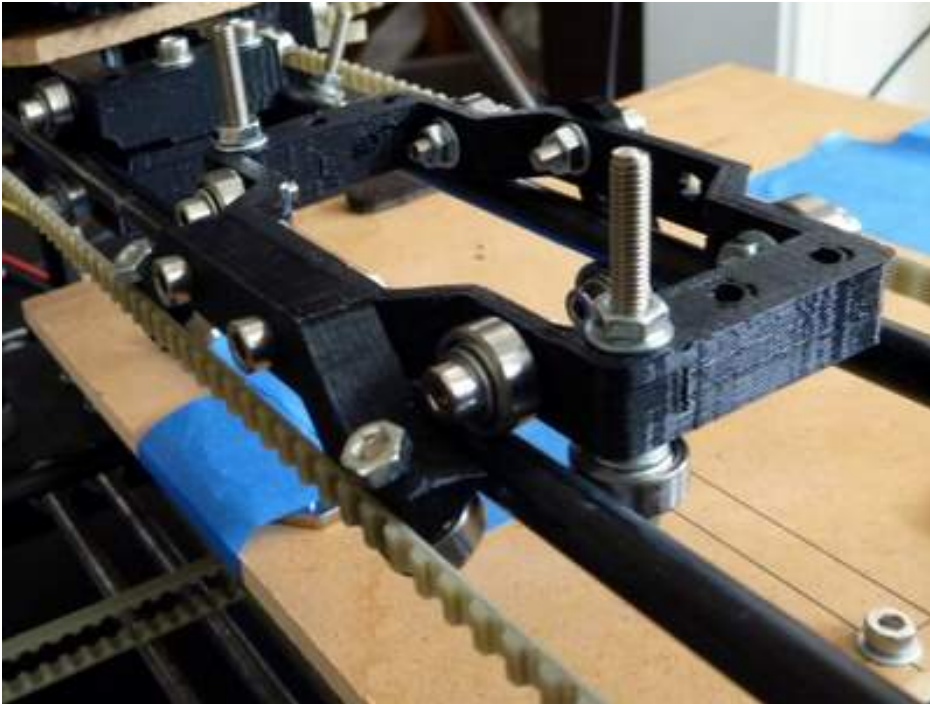

OpenX Carriage

Buback has released the design files for his OpenX Carriage. It's an amazingly elegant approach to simplifying the X carriage while retaining the bearings from the Sells Mendel, and it just looks awesome! I especially like his approach to the 360 bearings, it's one of those designs that when you see it you wonder why it wasn't done that way in the 1st place.

Volumetric Dimension settings

With the new Skeinforge 40 you calibrate based off how much plastic, by volume, is entering the top of the extruder per step, and therefore how much plastic is being pushed out the nozzle per step. Several folks have added setups for some of our most common extruders, cutting down a lot on the difficulty of setting skeinforge 40 up.

That's it for Best of RepRap Wiki this week, please comment below if you think I should continue this project, and if you want to get into next weeks blog post, be sure to update the wiki, post pictures, and keep being awesome.

Aha! RepRap appears do be doing MakerFaire!

Friday, 11th March 2011 by Sebastien Bailard

My spies at google tell me we're going to
Maker Faire UK in Newcastle this weekend!

-
Maker Faire UK 12-13 March 2011
is part of Newcastle Science Faire 2011



We've got a number of different folk doing up a number of different booths for a number of different Makerfares. If you are running one of the numerous Official RepRap Booth(s),, please let the rest of us know so we can show up and help self-replicate and so on! Helpful secret mailing list discussion thread for people organizing / attending booths

(Disclaimer: RepRap doesn't really do "official". As far as we can tell.
There may even be a rule about it.)

* Maker Faire UK
March 12th & 13th, 2011
<http://www.makerfaireuk.com/>

* Robot Fest/ Mid-Atlantic Mini Maker
April 30, 7am €" 12pm
<http://www.robotfest.com/>

* Toronto Mini Maker Faire
May 6-8
<http://makerfairetoronto.ca/makers/>

* Montreal, Libre Graphics Meeting (LGM)
May 10-13
<http://www.libregraphicsmeeting.org/2011/>

* Maker Faire Bay Area

May 21st & 22nd, 2011

<http://makerfaire.com/bayarea/2011/>

* Mini Maker Faire Ann Arbor

June 4th, 2011

<http://www.a2makerfaire.com/>

* Maker Faire:North Carolina

Saturday, June 18

<http://makerfairenc.com/>

* Maker Faire: Kansas City

Friday June 24 - Saturday 25, 2011

<http://www.makerfairekc.com>

* Vancouver Maker Faire

June 25 - June 26

<http://vancouver.makerfaire.ca>

* Maker Faire Detroit

July 30th & 31st, 2011

<http://makerfaire.com/detroit/2011/>

* Maker Faire New York

September 17th & 18th, 2011

<http://makerfaire.com/newyork/2011/>

Double Wade sighted in the workshop

Tuesday, 15th March 2011 by Vik Olliver

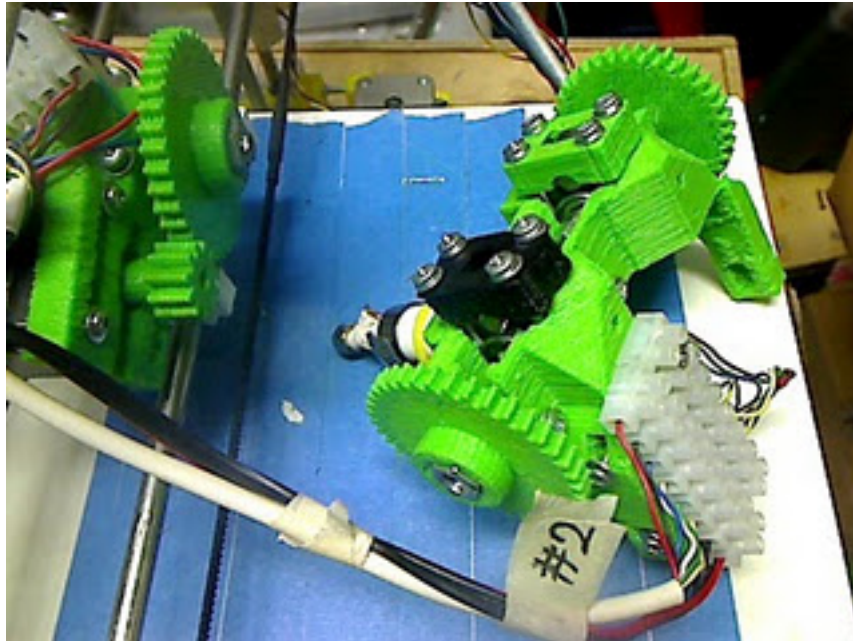

This is a Double Wade extruder <http://www.thingiverse.com/thing:6989> being wired up for testing. This assembly saddles across the X axis with one extruder overhanging. With the use of the Prusa-style X carriage <http://www.thingiverse.com/thing:6805> with PLA bushings running at 6000mm/min I can now span more of the X axis than I could with the standard Sells-style carriage, and Mendels tend to have more room on the Y axis for me to take up with extra extruder.

Note the twin terminal strip blocks for a head disconnect mechanism. They're clamped around some small nails, and loosening the screws on one side will allow you to remove the whole row of spikes at once like a plug. But this one won't shake loose :)

This is using FiveD/Teacup firmware on a single Arduino Diecemila to control "Custard Slice" (yes I name my RepRaps too).

Vik :v)

Automatic documentation and project evolution

Wednesday, 16th March 2011 by prusajr

While designing my Mendel, I found out that I really hate to write documentation. Thankfully, I met Kliment who did such an amazing job on documenting the entire Prusa Mendel build! But this is not a long term solution and I started to realize that changing the documentation with every commit to the repository is boring, so I tend to not to do it. :-/

One solution would be to mark one commit as somewhat stable and optimize the documentation to this point. Unfortunately this would slow down the adoption to the new features by community, so I dumped that idea.

Then I finally realized, that I need to generate it automatically. By that time we just included the makefile into the repository, and I found out that OpenSCAD, my software of choice, has ability to output stuff with an echo statement.

Example of catching output:

```
OpenSCAD -s test.stl test.scad > test.txt 2>&1
```

I immediately thought, "This is it! I can easily output what these parts use!!" And possibly create bills of materials (BOM), etc. For example: You have module called M8Nut() which will generate an M8Nut object for cutting out nut traps, etc. With every use it would output "m8nut" to the file 'test.txt'. After some experimenting I found a few problems:

- It could be used only for OpenSCAD files. I found this really bad 'bug', what if we have AOI or DXF stuff in our project?
- It would get really ridiculous, when you would be doing lock nuts, washers etc. There would be simply 'dumb' objects doing nothing, just outputting themselves to command line. Confusing, right? :-)
- It would be much harder to associate parts with each sub-assembly in full project tree. Also, you cannot use the OpenSCAD to generate the output, not even do the recursive counting, you still have to use another tool. !!!!!

Then I got stuck for few days. Finally, I remembered the JavaDOC comments, even though I hate Java. :-D Basically, I borrowed the style of syntax and comment blocks and started creating **ThingDOC!** I was writing the documentation for a few weeks in my Prusa Mendel files the way I found to be most natural, then writing of the ThingDOC itself began much later. Basically, I started after all files were already commented. Basic ThingDOC comments looks like this:

```
/**
 * Slides on the x-axis with extruder.
 *
 * @name X carriage
 * @category Printed
 * @using 4 m3x10
 * @using 4 m3washer
 * @using 4 m3nut
 * @using 4 bushing
 */
```

I don't want to talk about syntax here, there is already a wiki page about it. Let's talk more about what it can do now and what I will do in the future.

ThingDOC looks for these comments in files with .scad and .tdoc extension. It doesn't matter where you put them. This allows use for non-OpenSCAD things. Now its in stage where it can make a BOM for full project, recursively. For example, when you need 8 M8 nuts for one frame-vertex and mendel uses 6 vertices, it will add 64 M8 nuts to the final bill of materials. Even this alone is very useful, since you will at least have all the needed parts for the commit of repository you actually have, and you won't be missing something. It also generates nice summary of parts with their descriptions.

What does documentation look like from actual files in Prusa Mendel repository.

A more important thing, which is not as obvious is that it has a full tree of parts. This is more valuable then it looks like, since later on we can generate assembly documentation.

As I mentioned in above, my ultimate goal is to make the full assembly files automatically generated, in the quality you can find now on the wiki. I already have a plan how to do it. Of course it can't be fully automatic, but you will have at least **hyperlocal** assembly instructions, which would be structured and more easily recognized.

An example of why this is still beneficial even though it seems as same amount of work as now: Imagine that nophead wants to fork my Mendel, if he doesn't like one part (for example, the carriage) it would have completely different mounting etc. etc. So he forks the repository and does all the changes he wants to do, including documentation changes in the carriage.scad. He changed only one single file, but he's still able to generate documentation for full printer, and the documentation will make sense!

Hyperlocal documentation for the win!

Every commit will then have its own documentation. I know it sounds like science fiction but I really love this idea.

Project can be more living thing then rapid jumps every few months when new release is published.

Again I can show small example how this in connection with GIT is huge game changer! Once Original Mendel (as now community calls Sells) was released it became more or less untouchable thing. Only changes I remember in SVN was repairing STLs. At first because the SVN is bad for forking branching and even if someone wants he cant express his ideas there, its not open for everyone. And second, the release was so huge that everyone expects its final thing. In opposite, in my repository, things are changing on daily basis and community accept these changes fluently!! When I browse flickr and internet I can see how quickly community is using updated files etc. In repo is now many great changes by Spacexula, soon from GregFrost. I try to encourage guys to change and tweak. Prusa Mendel will never have something like 'stable release' or 'version 0.1', never!

'You have and idea? Go FORK yourself!!'And it works!!

Back to assembly instructions. How I want to do it: Since we already have the tree of parts it's easy to know where to start, from the roots, generating one subassembly after another, going up and up until full documentation is ready. Let me show it by example:

```
/**
 * Printer
 *
 * @root
 * @name RepRap
 * @assembly Make sure you have [frame] ready.
 * @assembly Second you make the [x-axis].
 */
```

```
/**
 * Printer base
 *
 * @name frame
 * @using 6 frame-vertex
 * @assembly Do the side triangles.
 * @assembly Connect triangles into frame.
 */
```

```
/**
 * x axis
 *
 * @name x-axis
 * @using 1 x-end-motor
 * @using 1 x-end-idler
 * @assembly Prepare [x-end-motor]
 * @assembly Prepare [x-end-idler]
 * @assembly Put both together with rods.
 */
```

So first it will generate the frame assembly instructions, since there are no other subassemblies, it will write it out. Second is the X axis but it has some things which logically must be assembled sooner than the x-axis itself, so x-end-motor part goes first, since its mentioned sooner, then the x-end-idler and so on with other instructions.

If you want to play with it, you can clone Prusa Mendel repository switch to development branch and run

```
git submodule init; git config -l; git submodule update
```

for initialization of submodules (ThingDOC is submodule). Then you need to install Python and LaTeX (sorry we love the output, but switching to mediawiki etc should be easy). Last you run shell scrip generate-documentation.sh and you are done!

I'm looking for other developers willing to help me with this. I find myself having less time for this than I would love to have, but I think it's an even more important thing than the Prusa Mendel itself . Or even if you don't want to help with development and have some ideas what this meta data could be useful for other than the BOM and Assembly instructions, leave a comment.

- [ThingDOC](#)
- [Prusa Mendel](#)
- [Example of documentation](#)
- [Josef Pra](#)

Jo

Best of the RepRap Wiki 3/18/11

Friday, 18th March 2011 by Neil Underwood

A few not so new items this week, but I have not seen some of these project get a very large audience yet.

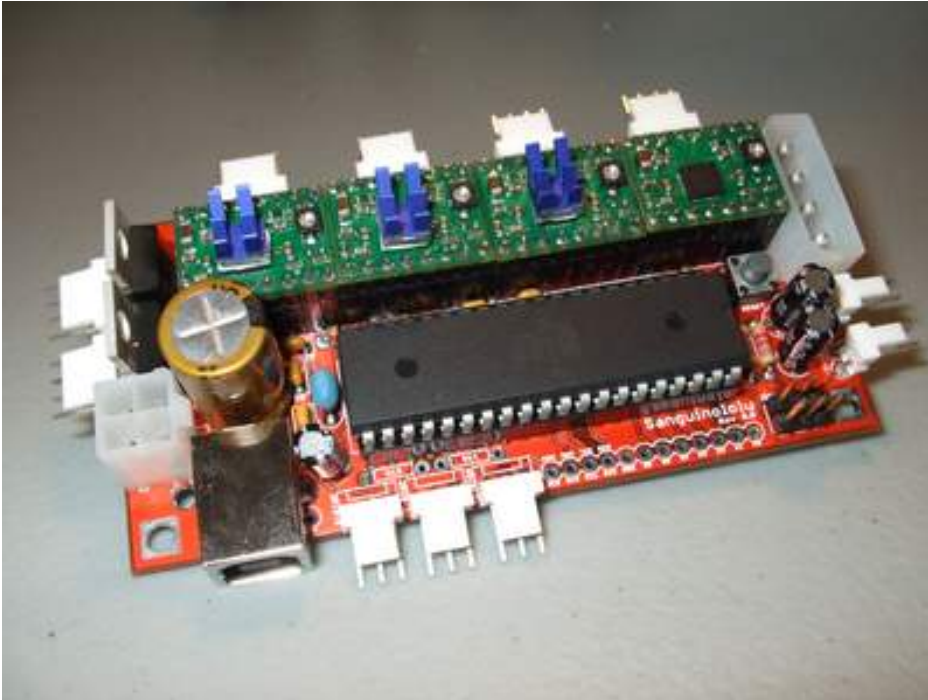

Sanguinololu

The Sanguino was developed by Zack Hoeken, and rests at the heart of Makerbot's Gen3 Electronics. The Pololu Electronics were developed by Adrian Bowyer, and is what inspired the Ramps electronics by Ultimachine. Joem has combined the idea of these two two electronics into a truly tiny set of electronics. He is on version .7 of the board, and quickly approaching a 1.0.



Ultimaker's_v1.5.3_PCB

Erik De Bruijn, one of the original RepRap Devs is coming along nicely on his version of the Arduino Pololu Electronics. He has been quite busy updating the RepRap Wiki, and his own Ultimaker Wiki. These are the electronics that are at the core of his UltiMaker. If your as much of a Wiki nerd as I am becoming, his wiki is worth checking out, he already has most of the build instructions posted for the Ultimaker.



Delta

There are some really amazing Delta bots in the Wiki, this one has been receiving a lot of edit love here lately. Will need to bring some of the others forward in the coming weeks. This wonderful example is known as Clavel and is already on it's second prototyping.

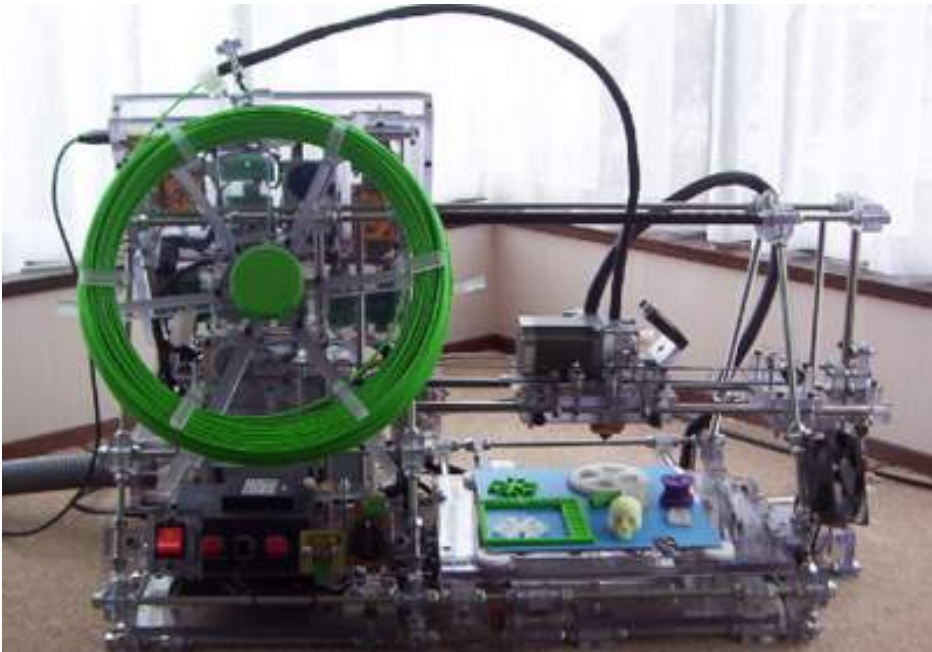

Kiwi M5 Mendel Battle Tank

This beast of a machine is the work RepRot, and as you can tell from the machine's name, it's another one of those crazy folk from New Zealand. This beast earns the name "Battle Tank".

-Made from bullet resistant plastic (I know I get shot at a lot while I print)

-24 Volt steppers (In case you decide to do 3d printing on Saturn)

-Over 700 Watts worth of Power Supplies (563 for the Cartesian, 150 for the HBP)

Good job RepRot, you just made 99% of the RepRap in the world look like wusses. :)

Print a Vacuum Cleaner!

Wednesday, 23rd March 2011 by Christopher Olah



Ever wanted to print a vacuum cleaner? Well, now you can! I've designed a printable hand-held vacuum cleaner that works (to some extent, at least!).

Build instructions are on my blog [here](#) with lots of pictures. You can also skip to the [youtube video](#) or [github](#).

Update: I've also posted to [thingiverse](#) and the [RepRap wiki](#).

Best of the RepRap Wiki 3/25/11

Saturday, 26th March 2011 by Neil Underwood

Open publication - Free publishing - More howto

Garyhodgson has uploaded a Prusa Mendel completely redrawn in Sketchup, and then used that drawing to create some really nice instructions. I can't describe these instructions in any way but gorgeous, they put all prior RepRap documentation to shame in it's simplicity. As most of you know RepRap has always suffered from poor documentation. These looks like something out of a computer hardware quick install guide. It also really shows off how flat out mechanically simple Prusa Mendel is.

He has uploaded the file to the wiki, and is maintaining a git for it. He has even made the document completely open licence, so you are free to evolve this document in any way you need.

Garyhodgson aka Gary Hodgson, my hat off to you for some amazingly useful work.

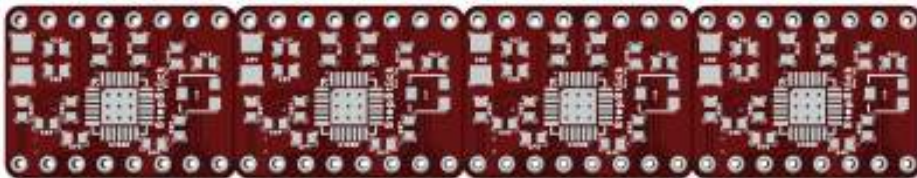

StepStick

Many in our community "felt the pain" when Pololu ran out of the A4983, This is the stepper controller most of our electronics uses, and it stayed out of stock for many weeks. Joem the Sanguinololu guy is also working on an equivalent open source version of the A4983. More details in the wiki page.

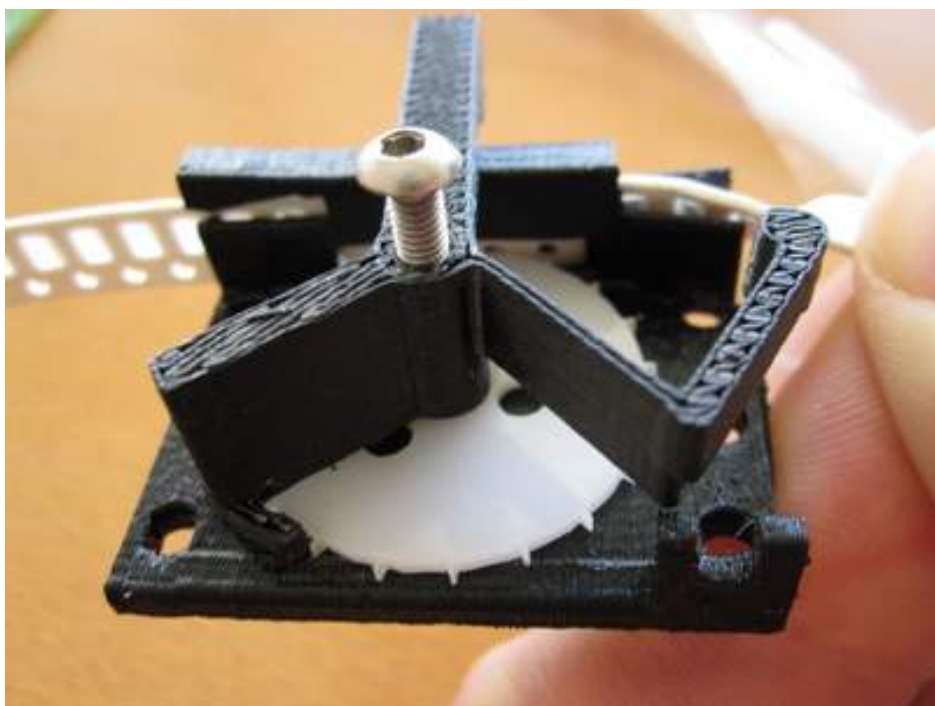

Pick-n-Place_Feeders :

ErikDeBuijn, of Ultimaker is at it again, he is now working on a pick and place machine. Given that he already has shown is RepStrap doing 300mm/s I am almost scared to see how fast it will do Pick - Place. Good job Erik!

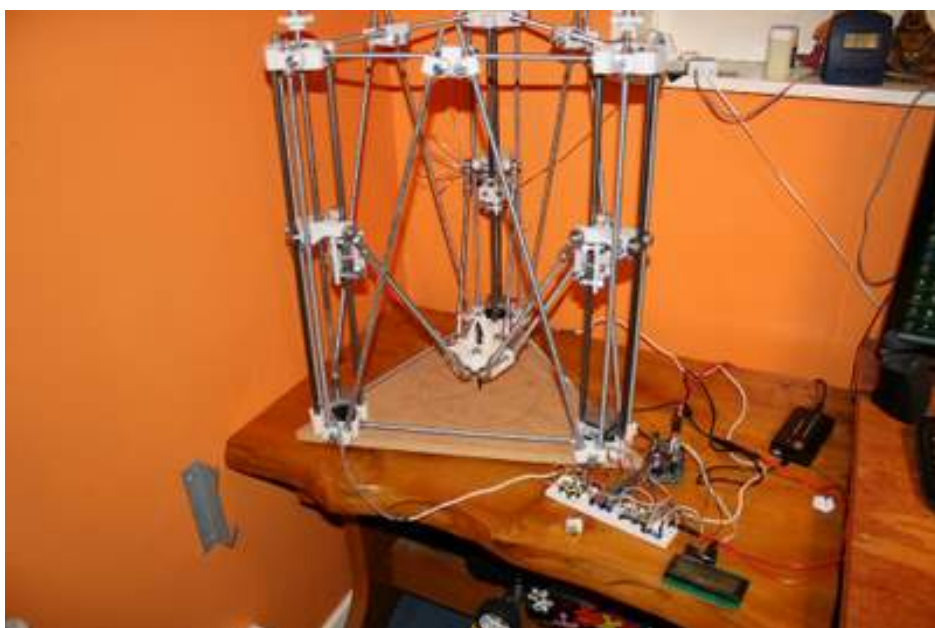

Helium Frog Delta Robot

HeliumFrog has a lot of really amazing projects over at his website. But my favorite has to be his printable Delta Robot. I mean really, even if it didn't even run, who wouldn't want that sexy beast in there shop? The great thing is it DOES RUN:

He has also very recently updated the software to run it, so it's by no stretch a dead project.

Updates without pretty pictures

Both the Generation_7_Electronics and the Sanguinololu electronics pages have had a lot of documentation added, both of these electronics are very quickly becoming real options.

Powder_Printer_Recipes : Sebastien_Bailard uploaded a huge set of recipes for powder printing.

M-codes_for_EEPROM_config : AlexRa did a large update to the EEPROM tables

Extending OpenSCAD

Monday, 28th March 2011 by Christopher Olah

```
// Frame vertex
// GNU GPL v2
// Rob Gilson, Chris Olah, Josef Průša, Vik, Tonokps

include <configuration.scad>
include <common.scad>

//Vertex Options
//=====

vertex_height=threaded_rod_diameter+threaded_rod_vertical_clearance*2;
FN=32;

//Polygon vertices
//=====
mid_l = 32;
mid_w = 20;

bot_l = 10;
bot_w = 10;

top_l = nut_thickness+5;
top_w = nut_diameter+8;

translate ([0,-15,vertex_height/2])difference()
{
  linear_extrude(height=vertex_height, center=true) {
    /* 7----- 6
       |  ==  | 5
       | 8   | 4
       | @   |
       | 0   | 3
       | \ 1_2 / */
    polygon(
      points=[
        //At the bottom of the vertex, a half hexagon.
        [-mid_w/2, 0],
        [-bot_w/2,-bot_l],
        [bot_w/2,-bot_l],
        [mid_w/2, 0],
        [bot_w/2, bot_l],
        [-bot_w/2, bot_l],
        [-mid_w/2, 0]
      ]
    )
  }
}
```

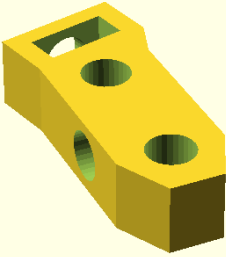

Parsing design (AST generation)...
Compiling design (CSG Tree generation)...
ECHO: "Frame Vertex Angle: ", 77.2906
Compilation finished.
Compiling design (CSG Products generation)...
Compiling design (CSG Products normalization)...
CSG generation finished.
Total rendering time: 0 hours, 0 minutes, 0 seconds

I spent the weekend hacking on openSCAD, and I thought people might be interested in the results. The most visible one is syntax highlighting, but I've also done a few language extensions:

- Dot/Cross Product (* and %)
- length function for lengths of vectors and strings
- accessing characters in a string via []

I've got a more detailed post on my [blog](#) (including some future ideas) or you can just grab the code from [github](#). Note that my work is not yet merged into mainstream openSCAD.

This week In The Wikii 4/02/11

Sunday, 3rd April 2011 by Neil Underwood

It's amazing how fast our community evolves. I have been doing this feature at the RepRap Blog for a month now and not once have I ran out of stuff to post. And in some ways each week seems to be a bit more awesome than the next. :) I know there are a lot of you guys and girls out there plugging away at your projects, if you want to see it here at the repprap blog PLEASE post it at this features's wiki page at:

This Week In The Wiki

If you post your project there with a link to your Wiki page, I will post it the following Weekend into the Blog. We are not picky at the RepRap wiki. If your project is related to a RepRap, or just uses a 3d printer or lasercutter to make it, your welcome to use our wiki to host your instructions! All we care is that it's open source.

Now for what is awesome in the wiki this week!

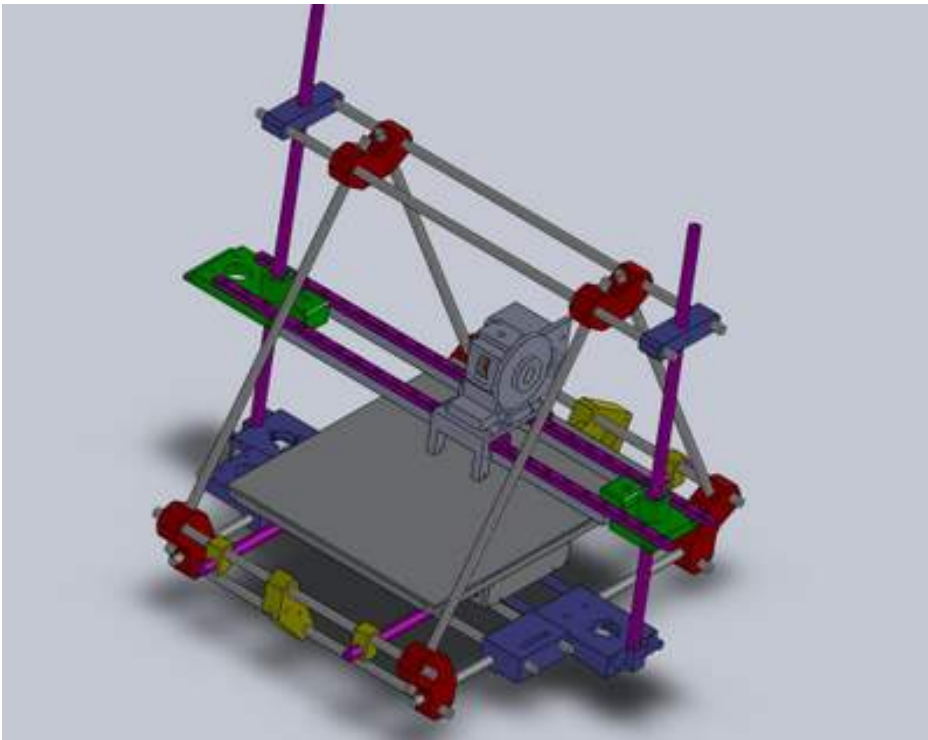

Mendel 3547

Poller uploaded some pics of the Mendel 3547, it is an interesting concept, somewhere between a Prusa and a Sells. Looks to be a bushing based Sells Mendel. No real documentation yet besides some projections.

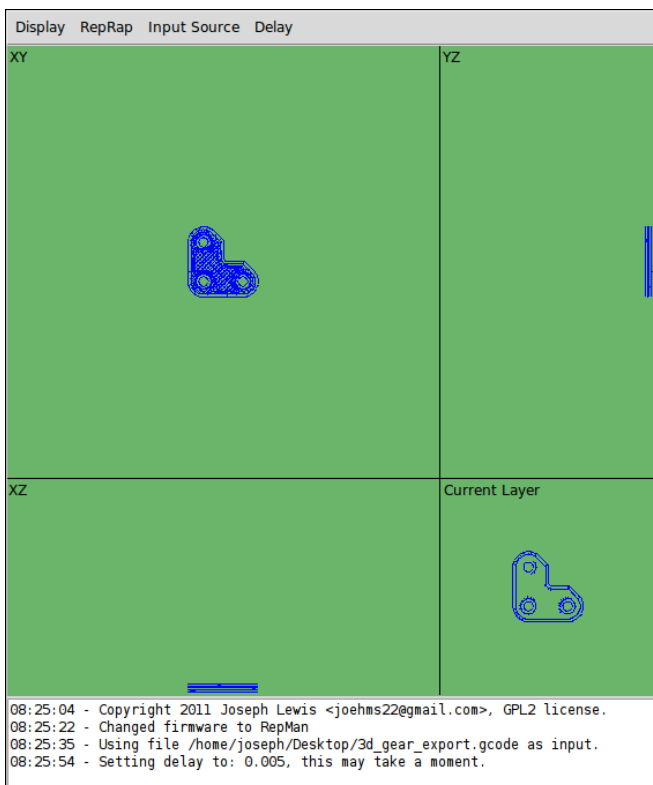

RepRap Franklin

Don't have a RepRap yet, but want to test your wicked awesome new firmware ideas? The emulator is easy to set up and run, can be used to test new programs for sending proper commands to a fake RepRap, before you destroy your own. Multiple firmwares are supported, and more can be easily added, allowing you to test on many different versions without flashing firmware between tests. Plus there is a speed boost as commands can be executed at any speed desired.

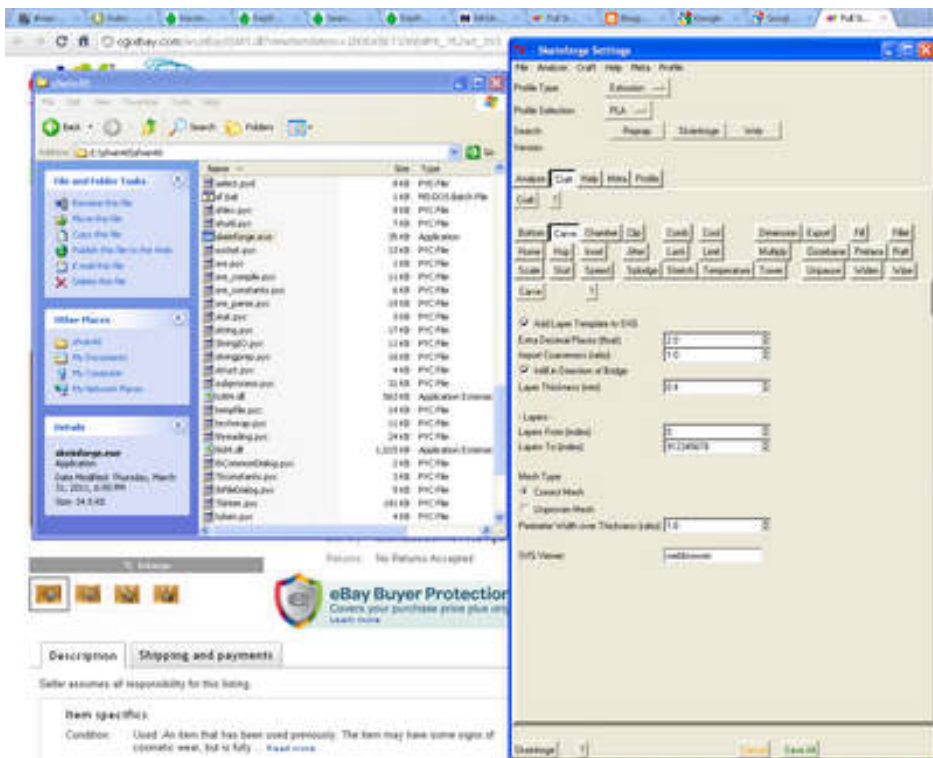

Portable Skeinforge

One of the 1st things that people who join our community complain about is that Skeinforge is not an .exe in Windows. Well Kliment has fixed this issue, and added a nice extra functionality to Skeinforge. Portable Skeinforge allows you to operate Skeinforge from a thumb drive and take your settings files with you. Also it allows you to run Skeinforge from a machine that you do not have access level to install Python on. Many of us have ran into this situation when doing demos at public schools or trying to goof off Skeinforaging objects at work. Considering in Windows repsnapper is a simple .exe file also, you can now run your reppap fully off a thumb drive.

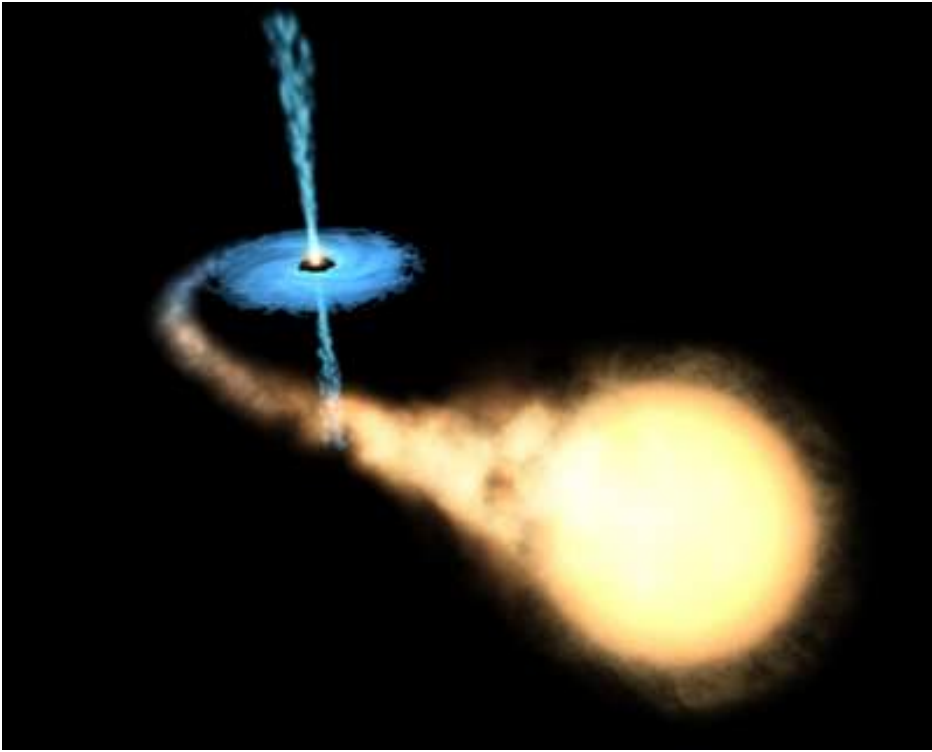

Community portal

I didn't even know we had this page, it was started by [TheOtherRob](#) and it's actually quite up to date. There's some cool things I did not even know we had. [Cafe Press Shirts and Hats with RepRap on them](#), and [donate buttons](#) for rewrap. I mean seriously, why don't all of us have these buttons on our pages? I didn't because I didn't know about them, must correct that. Lots of other cool stuff over there also.

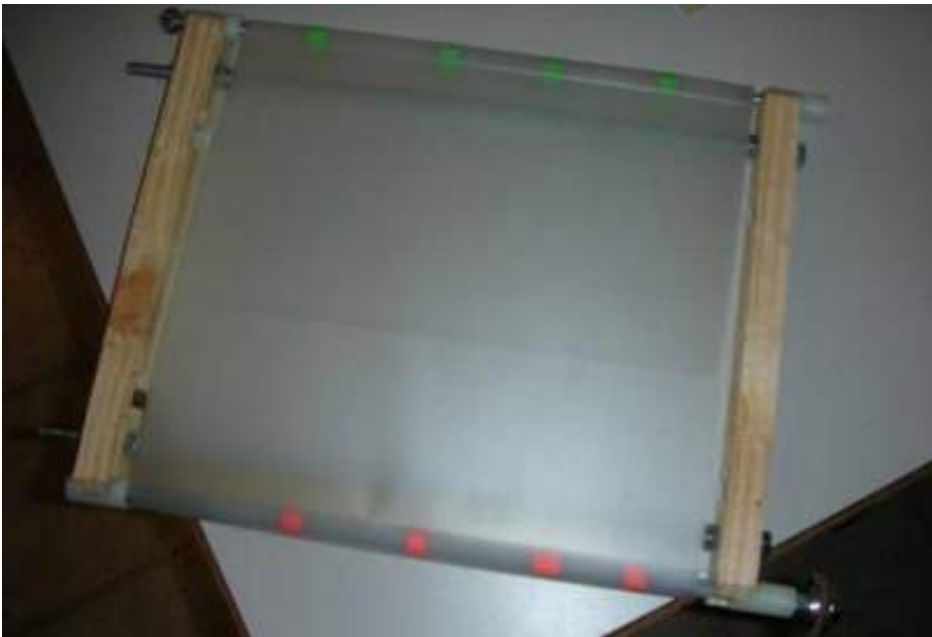

Exquisite Automated Build Platform

Jamesdaniely has been doing some serious work on the Mendel Automated build plate. He has added several videos of it in operation, and a much more flushed out instructions on how to build it. Considering Makerbot seems to be going to TITANIUM to get there's to work properly, I hope that James finds a magic bullet to make these work well. Automated build plates will be wonderful if we can get them to work reliably.

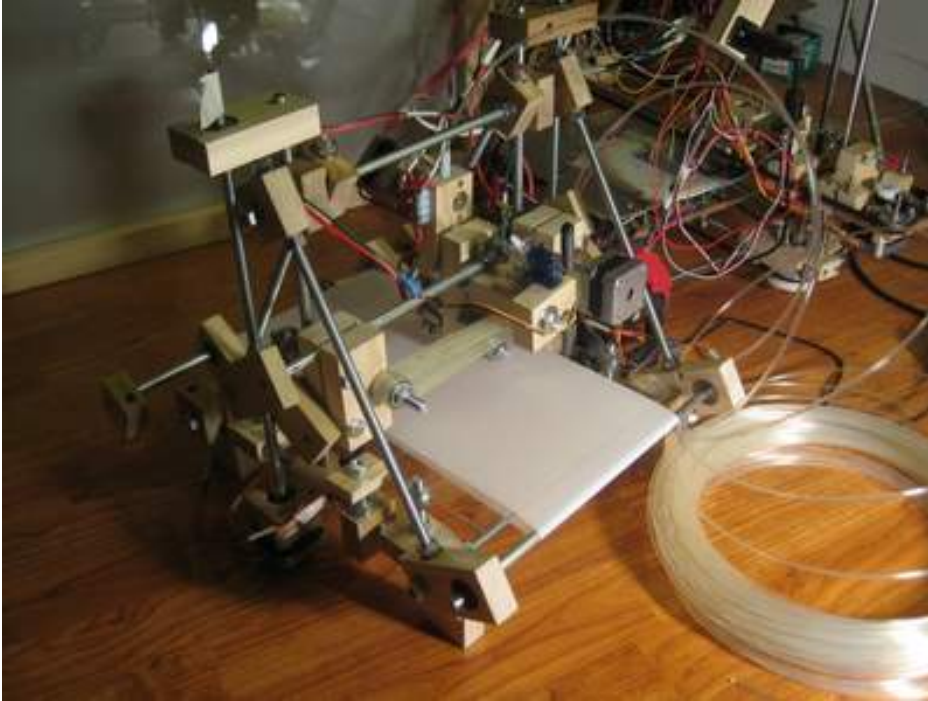

1X2

Mrkim has started the serious documentation of his 1x2 wooden repstrap. It's amazing what you can do with a few blocks of wood! I can't wait to see a few of these in the wild.

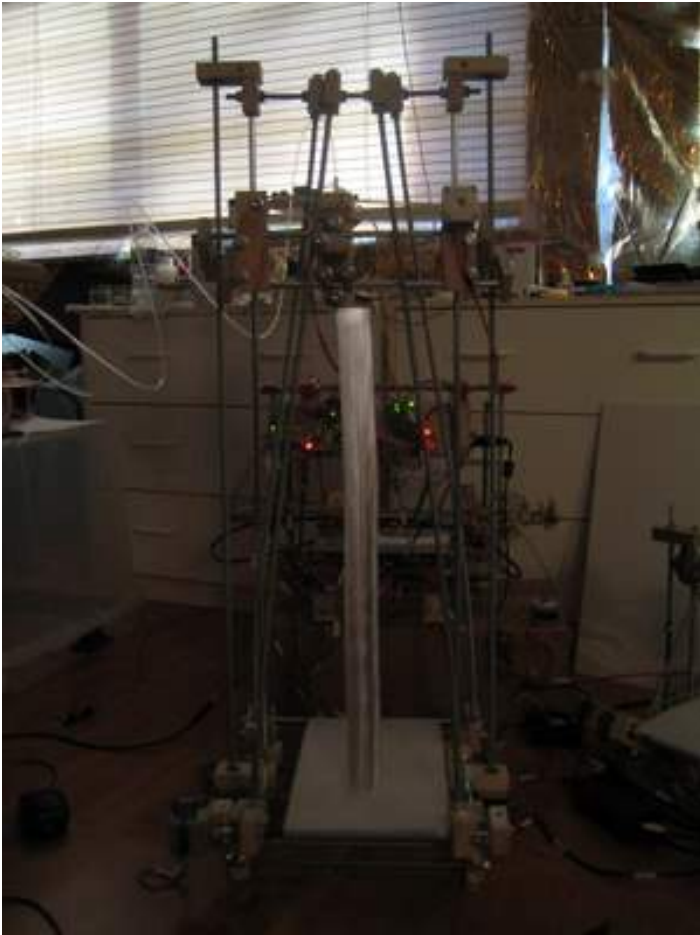

1X2_Tallcat

Mrkim As if that wasn't enough MrKim then proceeds to make the tallest 3d printer I think I have ever seen. I don't even think Fortus production machines have that type of Z envelope! :) Instructions for both this and the normal 1x2 are at the wiki page. I swear that printer is sort of scary looking.

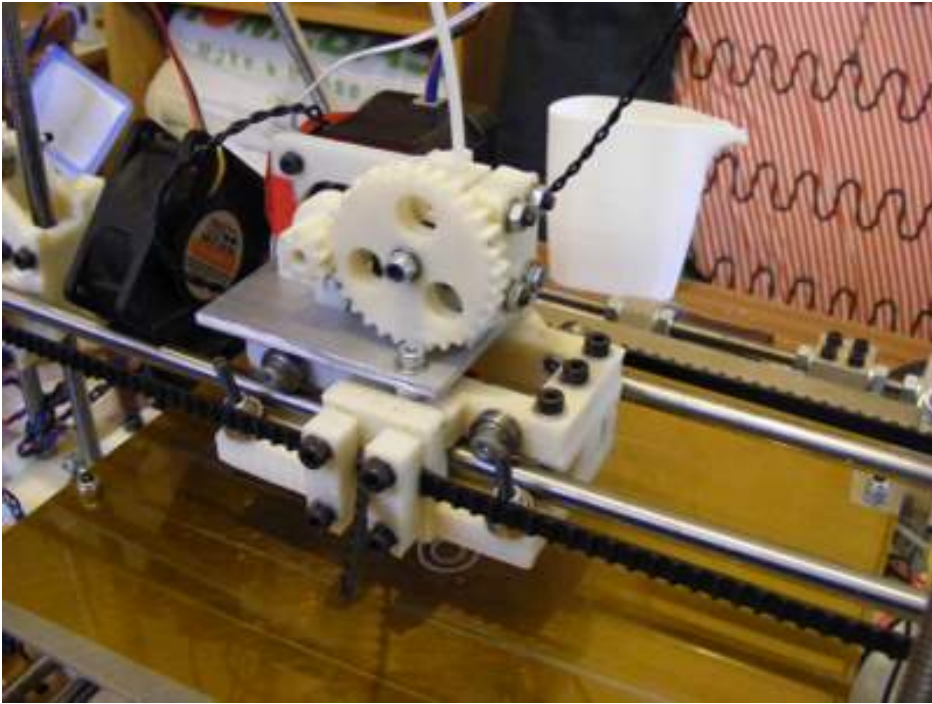

Mattroberts' Compact Geared Extruder

It's amazing how quickly our extruders in RepRap are evolving. Mattroberts has made a unique and small geared extruder, which is a hybrid of the Wades and Adrian's extruders. This one is physically smaller than even the wades, uses a m3 hobbed bolt, 624 bearings, and a 9:31 gear ratio. The good thing about the smaller hobbed bolt it it's much less force transfered to the plastic gears.

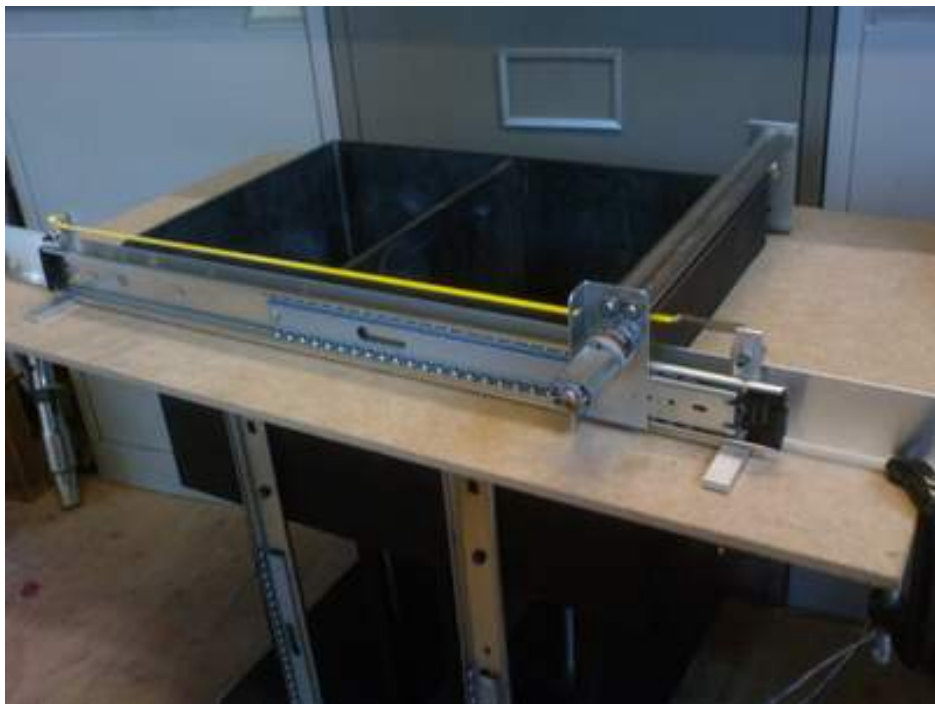

A5 Powder bed printer

More hardware progress with the A5 Powder bed printer. Sorry, I know I posted this one earlier, but I am a sucker for hardware pictures. :)



ReplicatorG-Skeinforge-RAMPS

Cloudmaker has managed to get RepG to play nice with standard RAMPS. I have not tried it yet, but I will tell you that if you start out with a Makerbot and try to move to RepRap, the most painful part is giving up RepG. Makerbot has put a lot of time and effort into the RepG program that the Makerbot kits uses, and it shows in the interface. I can't wait till RepRap user have as wide of variety of choices of drive programs as we do electronics.

Be your own souvenir

Monday, 4th April 2011 by Adrian Bowyer

Be Your Own Souvenir! from blablabLAB on Vimeo.

In Barcelona people pose in front of three hacked Kinects, are digitised, triangulated, then reprinted. They take away a personal model of themselves...

Sourcing a 3d Printer

Sunday, 10th April 2011 by Neil Underwood

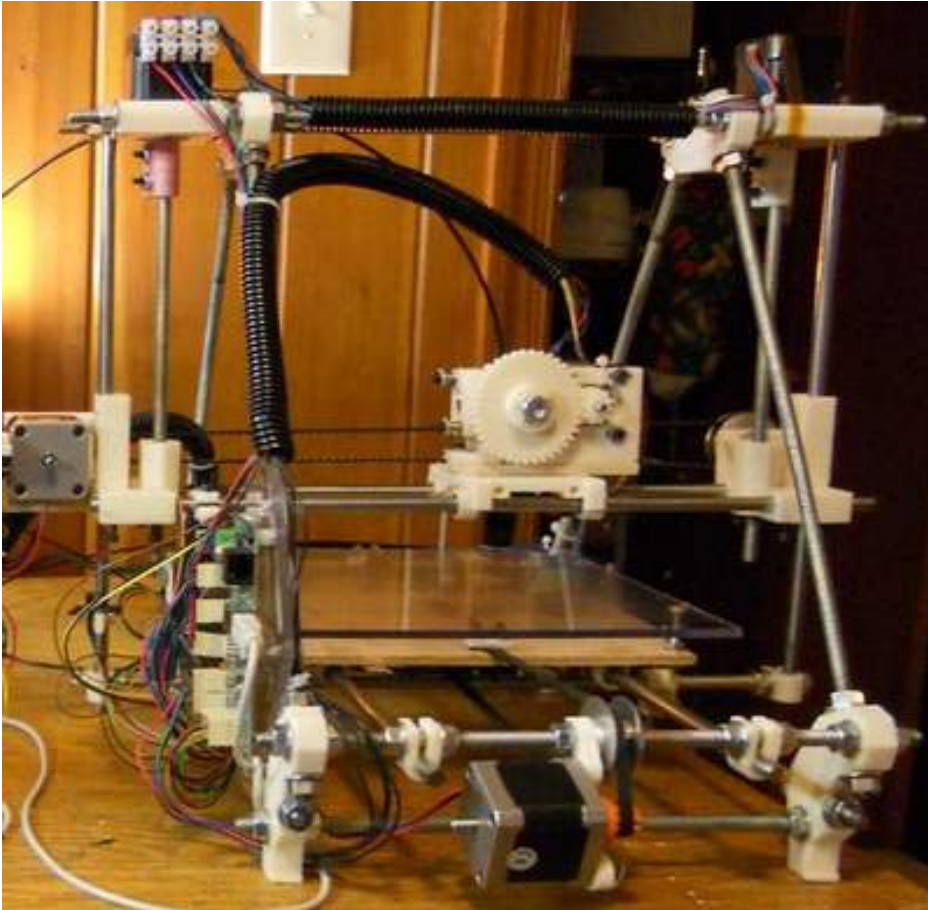

It's amazing to see how much the RepRap community has grown in the 6 years since it started, and little over 3 since RepRap 1.0 Darwin was released. We have gone from only being able to get the parts for a Darwin from commercial prototyping services that made the total build cost \$3000+ to today where you can put a Mendel together for \$400. This blog post is going to try to help a person figure out the easy ways to get into this hobby.

There are 2 main ways to get a RepRap or RepRap alike (Or Repstrap). You can buy a kit or you can self source. I am a very large fan of self sourcing because the difference between the cheapest kit I can personally recommend and the self sourced machine is \$425, or TWICE as much.

Self Source Open Source (The Cheap Skate Route)

A RepRap is made up of 4 categories of parts. Motors, electronics, RP (Plastic Parts), and Hardware: These parts are not hard to find, and no matter where you are in the world you can have them shipped to you. Below I will give a bit of a guide on how to find these parts outside of a

kit vender.

RP (Plastic Parts)

The availability of plastic parts has seen a real dramatic shift in availability in the last year. 24 months ago there was literally almost NO parts available for less than the commercial Prototyped price (\$1300ish), 18 months ago the parts were going for \$700ish on Ebay, 6 months ago they settled on an average of \$250-\$300, and now there is such a glut of parts that they are going for \$100 and cast \$50. This is part of the magic of the \$400ish RepRap. I find these to be the best places to find the RP Parts.

Print them yourself: I know, how do you print the parts for your 1st 3d printer when you don't have a 3d printer? Well believe it or not there are 3d printers all over the world, and most Metropolitan areas of the world now have at least 1 RepRap or RepStrap operator, if not dozens. Before you go buy a kit, or buy parts off the internet search your local area to see if someone has a Makerbot, RepRap, or other 3d printer. You would be amazed at how friendly our community is. The best places I have found to find Local 3d printer operators are:

The RepRap User Groups : Even if you don't find anyone in there, post that you're trying to get the parts, there is a very good chance that the 3d printing bug has infested someone else in your area.

The RepRap Map : This will let you know if someone is in your area, most the time people don't put links for people to contact them here, but 90% of the time there is enough info in the link to hunt the person down

The Makerbot Map : Same thing but for Makerbots. There is a LOT of people who have bought Makerbots,

The Makerbot User Groups : Makerbot has compiled a nice list local MB user groups.

Buy the RP parts: This is the most common way for people to build their 1st RepRap. There are plenty of different places on the internet to get the parts. The most quality dependent part of the print is the gears, so when you buy the parts, insist on a good photo of the gears, you are looking for very well defined teeth on the gear. Here is where I suggest you get the parts:

RepRap IRC: Our community's IRC channel is a hopping place. The reason I say go here 1st is because by buying your parts in this channel you're also helping out the people who are most likely going to help you get it running.

Emakershop Jeanmarc from the IRC runs this webshop. The great thing about it is that it has a variety of vendors (you can literally self source JUST out of his shop for \$550ish (if everyone is in stock, which they are not now). Lots of us like this vendor because he does not charge a transaction fee. Only thing you have to pay is Paypal fees.

Ebay This is likely going to be the most expensive way to get the parts, because with Ebay there is no way to get around the doubt hit of Paypal and Ebay fees. Unless you just have to don't buy parts here.

RepRap Forum Parts go up for sell in the Forum all the time (less than you will find at any of the other choices), but people do sell there. 1 note it is VERY easy for people to "Puppet" in our forums, so you never know if the reviews listed there are real or someone being dishonest. Most the Ebay sellers also sell here, so buying in the forum allows you to skip the Ebay fee.

Metrix Clonedel These are the cheapest parts, and I have personally reviewed their products,

they are good enough replacements for the printed parts. They do require processing with a drill press.

Electronics:

The electronics are the heart of your machine, and the part of the machine that most effects your overall experience with the machine. I have experience with RAMPS, Gen6, Gen3, and Gen4. All have worked well for me. The big difference between these electronics is the cost / firmware support you get with them.

RAMPS Is currently my favorite electronics. Mostly because it's both "single board" & modular, has provision for controlling a heated build plate, has the most active development (3 separate teams competing and working together on firmware for it), and it's about the cheapest electronics I can suggest (\$140 if you do it yourself \$200 if you get it preassembled. It's sold by Ultimachine, or you can etch it yourself.

Gen6 Is my second favorite choice. It does not have provision for a heated build plate, and it has the least active development team as far as new firmware. It's not etch-able, and is only available from 1 vender, Mendel-Parts.com. But is the simplest set of electronics to install, and it does work. It's \$200 with optos.

Gen4 is my 3rd favorite electornics. This is the official Makerbot electronics, but you could use it on a RepRap. The up side of Gen4 is that it will out of the box use ReplicatorG, which I think is one of the easiest RepRap control programs, the down side is that Makerbot sells it for \$370. That's twice as much as it costs to put together RAMPS, and 4 times as much as a Sanguinololu.

Gen3 and the multiple derivatives thereof. There are many companies out there that sell a version of these electronics, but in the end they are 2 years old, and it shows. Gen3 was problematic, but at the same point LIGHT YEARS ahead of what we had before. Zach and the guys over at Makerbot did a wonderful job on these, but they are just old now. If you can pick up a set of these electronics cheap, great, but just remember even at their best they where fussy, and no one is writting firmware for them anymore. They can be had for as cheap as \$165. The Real Gen3 are no longer sold or supported by Makerbot.

The Self Source options. If you have the ability to create your own boards, there are some truely cheap and nice options out there for you like Adrian's Ramps, Gen7, Sanguinololu, or even self etched Arduino_Mega_Pololu_Shield.

Electronics can be as cheap as \$100ish all the way up to nearly \$400 depending on which set you go with. It's up to you.

Your also going to need a power supply. If you plan to not run a Heated build plate, you only need 60W for all these electronics. The power supplies are usually avialable where you buy your electronics, and are either ATX power supplies (Desk top Computer supplies), or Laptop Supplies (Solid state but smaller).

If your going to run a heated build plate your going to need a high amp power supply, so an ATX or Laptop supply is not going to cut it. You will need something like this:

http://cgi.ebay.com/ws/eBayISAPI.dll?ViewItem&item=120571991063&ssPageName=ADME:X:RTQ:US:1123#ht_3368wt_1139

Just search "12v 20a universal power supply" in ebay and you will see tons on them, just buy the cheapest one.

Motors:

Motors can be the easiest or the hardest parts to source. All that really matters is that they are NEMA 17 (I know it's "possible" to run a RepRap on Nema 14, but don't even try, it's way more trouble than it's worth) they must be bipolar (4 wire), and have a holding strength of 40 N-cm at an aperature lower than your driver . Remember if you get 3 amp steppers most of our electronics only push max 2amp, so your not going to get the rated strength, but if you get a 1amp motor (that has the right strength), you can run it on a 2amp driver, just remember not to max the pot on your stepper driver! When in doubt buy a stronger stepper than you need, because there is no way to make a stepper have more torque than it's rated for. I use 53.1 N-cm motors just beause the last thing I want to deal with is a skipping extruder stepper motor. Here are some links to motors that look about right, or I have used to give you an idea what you want.

<http://www.alltronics.com/cgi-bin/item/N1728D63/55/OSM-NEMA17-Dual-Shaft-Stepper-Motor>
<http://www.alltronics.com/cgi-bin/item/N1728S56/55/OSM-NEMA17-Single-Shaft-Stepper-Motor>
<http://ultimachine.com/content/kysan-1124030-nema-17-stepper-motor>
http://www.mendel-parts.com/product_info.php?cPath=25&products_id=33
<http://www.robotshop.com/soyo-reprap-stepper-motor.html>

Any of those would work, but you can buy what ever you want, just remember 1-2amp 40ncm (Good converter if they play games with different numbers), Bipolar, 4 wire.

Hardware:

Hardware will depend on which machine you choose to build. I have built a Makerbot, Thingomatic, Huxley, 3 Sells Mendels, and well over 5 Prusa Mendels at this point. You can see videos of all the builds over at my Youtube Channel. The newest and in most active development RepRap is the Prusa_Mendel. The advantage of the Prusa is that the hardware costs are a fraction of the Sells Mendel, and it's much easier to calibrate/assemble. Here is a video showing the two machines side by side.

Assuming you go with the Prusa, you can get most the hardware locally. The Threaded Rod will be at your local hardware store, the screws you need (SAE if your in the US, Metric anywhere else), will be at the hardware store also (you might have to search in google maps for a thing called a "Fastener Supply" in your area to get the right sizes. Also your going to need Smooth Rod. If your self sourcing I am assuming your not rich, so just get "Tool Rod", or "Drill core". This can be also sourced locally from a machine shop, the Fastener supply, or even from old junk printers, that almost always use 8mm or 5/16 smooth rod. The only bearing a Prusa uses is the 608 bearing or "Skate board bearing". Before I started doing support in the RepRap IRC I never knew that every country in the world had Skaters, but they do. They don't need to be fancy, the cheapest 608 you can find will do (I have even used 2nd hand bearings from the skate shop).

Some Hardware is harder to find locally, such as the belt, you will need .2" or t5 (t5 is the spec belt, but .2" will work)

In the US I have found these suppliers to work great and be cheap:

http://shop.polybelt.com/T5-Belt-Metric-Trapezoidal_c79.htm

<http://www.mcmaster.com/#7959K24>

Your also going to need hardware for your extruder. This is the part that handles to molten plastic (hot end), and the part that pinches the plastic (cold end), so it's very important that it's done right. You can make these yourself, but unless you are a machinest I really suggest you just buy the parts (at least for the hot end). These are a few vender's I know work well.

<http://www.makergear.com/products/operators-pack>

<http://shop.arcol.hu/item/arcol-hu-hot-end-unassembled-035>

Hobbed Bolt's are what is used to pinch the plastic. You can use a gear to do this, but the hobbed bolt seems to work much better. They can be found from a variety of vender's on ebay, and only take about 10 minutes to make yourself with stuff you likely already have sitting around your shop. You can search eBay for them [here](#).

The only other hardware you will need is bushings if you chose not to go with PLA sliders (which a lot of people love). I have used both of these:

<http://www.mcmaster.com/#6391K163>

http://cgi.ebay.com/2pcs-LM8UU-8mm-Linear-Ball-Bearing-Bush-Bushing-New-/220692549334?pt=LH_DefaultDomain_0&hash=item33624d0ed6

This should get you a good way though self sourcing a Mendel, but if you have any questions go to the [Prusa Mendel](#) in the Wiki, or go into [RepRap IRC off freenode](#).

The Kits:

I would say that purchasing a kit has always been the most common way to start in this hobby. That's changing now because until recently it was almost impossible to source the plastic parts, and the RepRaps were much more challenging to get running than the kits. This is not the case any more. But none the less, a kit is an option that is perfectly reasonable if your time is worth more than a few hundred dollars. Again this is not a complete list of Kits, but only the ones that I would recommend to a friend.

[Makergear Prusa Mendel Kit \\$825](#)

There are cheaper kits, but I have seen enough issues with them that I can't suggest them. This kit comes with all the bells and whistles you could ask for on a RepRap. Heated build plate, big power supply, bowden extruder, geared stepper, stainless steel, etc etc. It's around \$300 more than self sourcing, but only about \$150 more than if you were to try to buy all the components

individually (good luck on them being in stock). This kit does have the advantage of being the same as a Self source Mendel, so you can get direct support for it though both Makergear IRC and RepRap IRC. Build area is 200x200.

Makerbot Thing-O-Matic \$1300

I love to hate on the Makerbot because they went up \$500 on their kits cost in the last year, but the Thingomatic, which is the follow on the the Makerbot Cupcake is a much improved unit. Their Mk6 stepper extruder is much improved over the Mk4 Extruder that I got with my \$750 cupcake. Build area is the smallest of the available kits at 110x110.

Rapman 3.1 \$1300

The Rapman 3.1 is based off the Darwin platform, but has evolved steadily over the 4 years it's been around into a very solid machine. It's the 1st machine I will mention here that is not fully open source. The Rapman 3.0 designs where released, but 3.1 never was. And the Electronics where never released at all.. It also Uses a closed source Program call Nettfab to drive the machine, but every person I have ever talked to that used it loves it. Nettfab has a free version and a pay version that is \$400+ dollars. It does have the 200x200 typical RepRap Build area.

Ultimaker \$1725

The Ultimaker by Erik has not been released yet, and to my knowledge no one outside of people associated with Erik own one. But at the same time Erik has a GREAT name, and the machine looks to print very well in the videos. The Ultimaker uses a bowden cuple extruder to get extremely fast x/y motion (300mm/s). 200x200 build area.

Up! 3d printer \$2700

I am likely going to catch heck for suggesting it because it is ZERO open source, but so is Rapman 3.1 at this point so who cares? The Up! has wonderful build quality, and is the only sub \$5000 printer that you can literally take out of the box, set up in less than an hour and print with.
Build area 150x150

Conclusion

I hope this helps. I am sure I missed some very good suppliers that I just don't know about, so if I missed you please comment below. The above is just 1 man's opinion, and not official RepRap policy, because RepRap does not do official. Like always if you have question please go search the Wiki, and ask questions in the IRC.

Big RepRap Refereed Journal Article

Thursday, 14th April 2011 by Adrian Bowyer

We have just published a paper in the journal Robotica about how RepRap started, its development, and how it has got to where it is now .

It is, of course, a scholarly engineering article intended for academics. But it is - we hope - also a good read for everyone.

[You can get a copy from the Cambridge University Press website here.](#)

The citation is:

Jones, R., Haufe, P., Sells, E., Irvani, P., Olliver, V., Palmer, C., and Bowyer, A.: RepRap €“ the replicating rapid prototyper, *Robotica*(2011) volume 29, pp. 177€“191. Cambridge University Press.

Rewriting history

Monday, 18th April 2011 by Adrian Bowyer

Erik, of course, has done a superb job of estimating the World population of RepRaps together with RepRap-derived machines like MakerBots and 3D-Systems/BfBs.

But I was recently asked for the history of just the RepRap population. I, of course, replied that - like the other 7 billion of you - I didn't have a clue. They then asked for a guess. Well. I can guess as effectively as anyone else, so here's what I said:

The numbers in [brackets] are estimates at the numbers of working RepRaps in the world. Only the first of these is certain...

Spring 2007 - The first RepRap Darwin was finished. Its RP parts were made in a Stratasys Dimension.

[1]

During that summer we made four or five sets of parts for the machine in the Stratasys and sent them to RepRap team members round the world.

30 September 2007 - Vik Olliver in New Zealand finished the second Darwin.

[3]

Around Christmas 2007 - A number of people start to make wooden and lasercut copies of Darwin. The Bath RepRap Lab also supplied a Stratasys-printed set of Darwin parts to Ian Adkins of Bits from Bytes, who created silicone moulds from them and started selling Darwin copies made by PU moulding.

[8]

February 21, 2008 - Zach Smith (now also of MakerBot) gets his Darwin working.

[20]

February 22, 2008 - Ponoko have a lasercut version of Darwin.

Spring 2008 - Lots of the wooden and moulded Darwin-type Repstraps are working, and people start using them to print RepRaps.

April 2008 - Nophead starts printing Darwin parts on his Repstrap Hydraraptor.

[60]

29 May 2008 - Vik Olliver's Darwin has made a full set of parts for another Darwin; these are assembled in New Zealand and finally tested when he visits at Bath University in the UK. This is the first true RepRap replication.

[100]

Summer 2009 - RepRap Mendel introduced.

[400]

Around this time Nophead, I, and many others went into serious production selling reprinted sets of parts for RepRaps made in RepRap machines on Ebay etc.

Summer 2010

[1500]

Spring 2011

Nophead alone has made over 100 RepRaps for other people. I have made over 50.

[4000]

That's my recollection. But the RepRap crowd is an especially wise one, so all corrections and additions would be most welcome in the comments to this post...

New Extruder Design

Friday, 22nd April 2011 by Adrian Bowyer

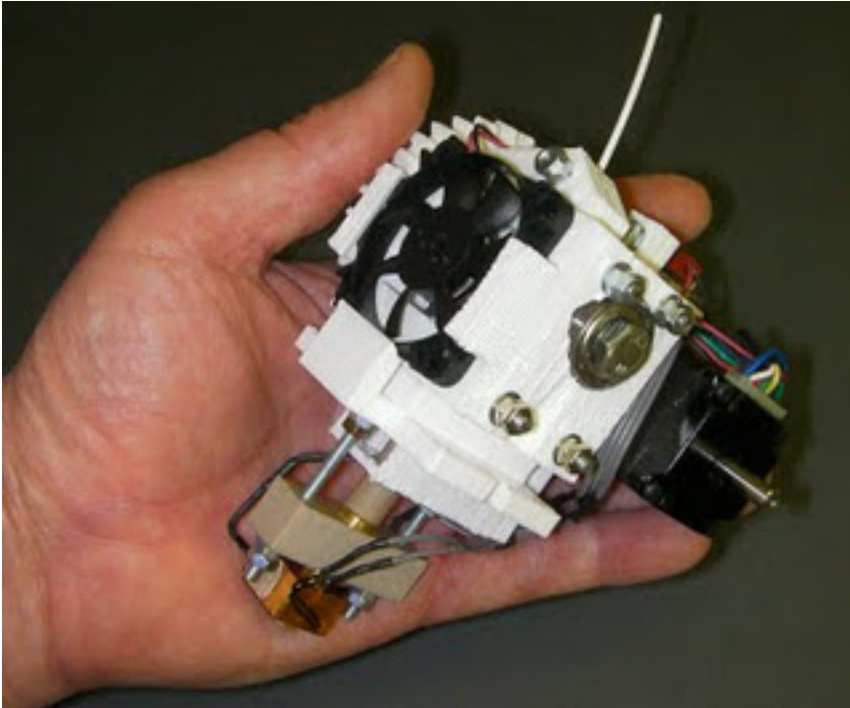

I have (finally) finished my 1.75mm filament extruder design for RepRap.

I say RepRap - in fact, by simply changing its adapter plate (called `base_plate` in the design), it should go on virtually any 3D printer. The standard design fits Mendel (both the standard one and Prusa). I will shortly do a plate for Huxley too.

It features:

1. Very compact high-torque NEMA 11 motor
2. Active ducted fan cooling for high reliability
3. Wade-style hobbed bolt filament transport
4. Wing-nut drive to spread the torque loading on the plastic gears
5. Push-fit hot-end parts - no thread cutting
6. Easily replaced PTFE liner for the hot end
7. A single M3-threaded rod cut to lengths makes all the fixings
8. Lightweight: 420g (about 60% the weight of this extruder)
9. Compact design (110 mm x 90 mm x 80 mm)

It's all here on the RepRap Wiki.

And here's a video of it printing itself:

RepRap Universal Mini Extruder from Adrian Bowyer on Vimeo.

UK RepRap Master Class

Wednesday, 27th April 2011 by Adrian Bowyer

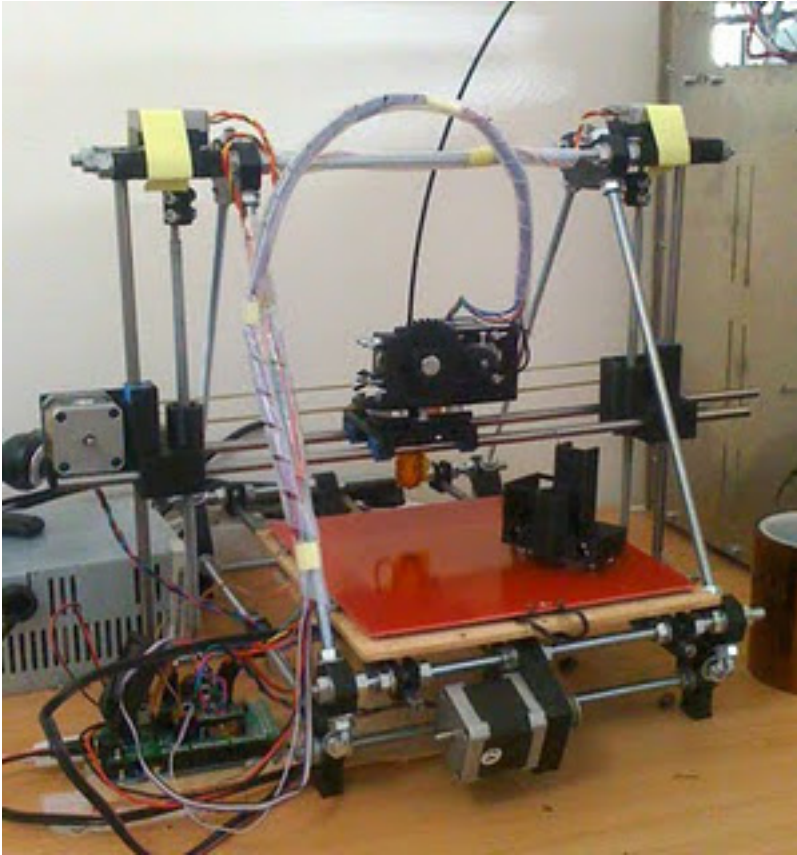

If you're thinking of getting into 3D printing and don't know where to start, then we have just the ticket for you. [eMAKERshop](#) have teamed up with the Bath University RepRap research team to bring you our first UK RepRap Master Class over the weekend of 1/2/3 July 2011.

The format is simple. For a fee of £575, participants will be provided with all of the hardware and software, along with expert guidance, over the course of the weekend, to build and commission their RepRap 3D printer. There are other ways to get a one of these machines functioning, but these involve substituting cost with lots of time spent researching, sourcing and learning to get the best out of a RepRap 3D printing machine.

The Master class will be run in the RepRap project's home town of Bath, UK, by some of the most experienced reappers, including Dr Adrian Bowyer €“ the creator of the RepRap project, Josef Prusa €“ the originator of the Prusa Mendel design, and other prominent figures within the RepRap community.

For more information and to sign up, [please click here](#). We look forward to seeing you there this July.

Sampo: The return of Darwin...

Wednesday, 27th April 2011 by Forrest Higgs

Actually, Darwin never really left.

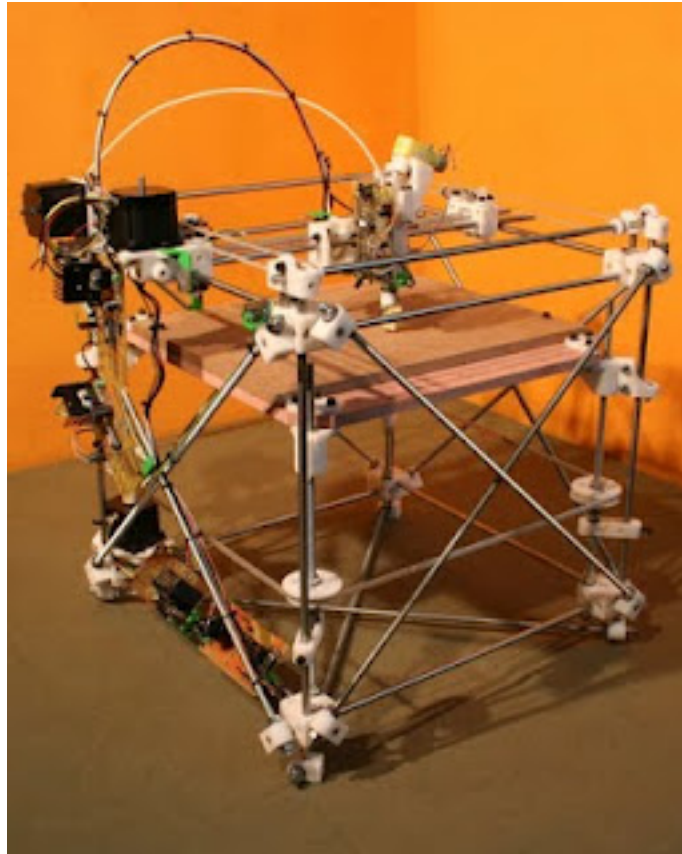

Despite all of the hoopla about Mendel, a very robust Reprap machine which is virally spreading like a bad flu, Darwin derivatives have been quietly building up numbers largely through Bits From Bytes' Darwin-derived Rapman printer. It would be fairly safe to say that there are upwards of two thousand of these Darwin clones of one flavour or another in the field.

I bought a Rapman 3.0 in the Fall of 2009.

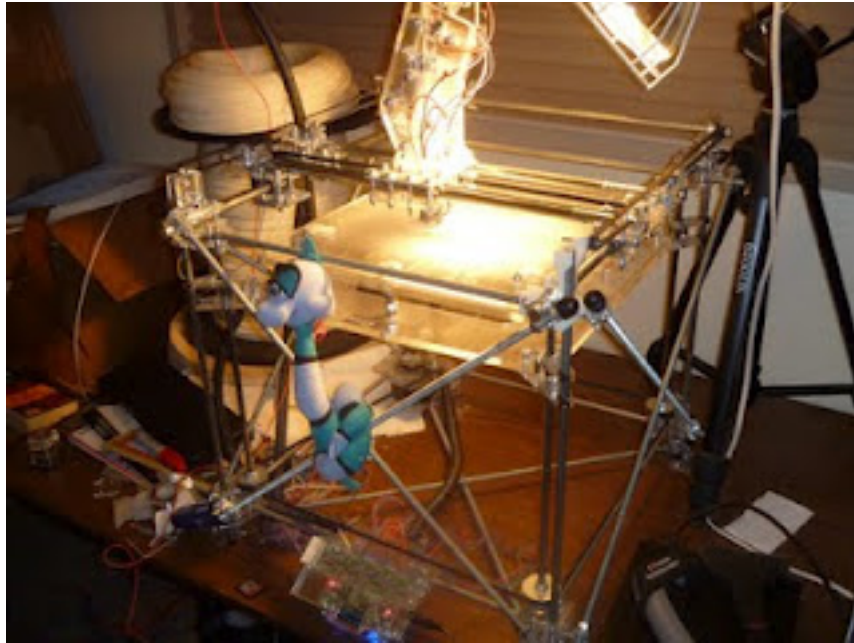

Rapman is basically a Darwin re-engineered for laser cut acrylic plastic instead of printed parts.

I've never been able to decide whether Rapman is a crib of the Ponoko laser cut acrylic Darwin or vice versa. The Rapman was a brilliant choice for me. I had been working on a series of Repstrap systems. Early on in 2009 I realised that getting Tommelise 2.0 printing was going to take another half year at the rate I was going and what I really wanted to do was design things with a 3D printer in the design loop. I saw Batist Lehman's video of his Rapman in action and was sold.

Of course, Rapman has its little ways. It arrived disassembled as a flat pack. Inside were several sacks of metric nuts and bolts heavy enough, if put in a sock, to serve as a very effective cosh.

Assembly was a daunting task and once finished there was a strong sense that you don't want to fool around with it for fear that it would break or come apart.

I was puzzled at first that lock washers hadn't been included with the nuts and bolts. It quickly became apparent, however, that if you put enough torque on nuts to make a lock washer compress the high impact acrylic that Bits from Bytes used would shatter. The net effect of this was that I keep a bowl beside my Rapman to collect the constant drizzle of nuts and bolts which unscrew themselves and fall on my work table.

Since then I've put well over three thousand hours on my Rapman. It became apparent some months ago that Rapman was not a heavy duty machine. I started seeing stress cracks all over the machine and was faced with a x-axis extruder mounting plate that just crumbled away from the heat of the extruder and the mechanical stress of being moved around. I replaced it with an equivalent aluminum plate.

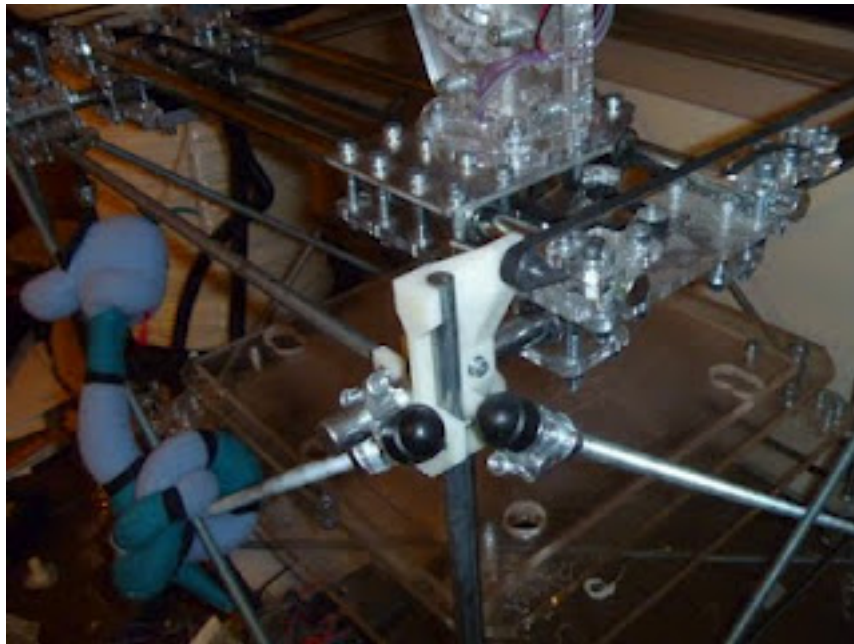

Early on Rapman users began to design replacement parts for the bits of the Rapman laser cut acrylic that fell apart. You can see a corner block designed in white ABS by Chylld in the picture above.

You notice that I only put ONE of Chylld's excellently designed, fast printing corner blocks onto my Reprap machine. Once I got it on it has performed beautifully. Unfortunately, I had to half way disassemble my Rapman to get the damned thing installed. That wasn't an experience that I thought worth repeating.

Late in 2010 I decided that I wanted to experiment with dual extruders. Bits from Bytes had come out with one some months before and I decided that I would get one. When I called, they were so focussed on their new 3000 printer that they wanted me to switch over to that and did a hard sell. I never react positively to hard sells, so I put off the purchase. As well, the dual head Rapman had the same dimensions as the old one which meant that it had a reduced print table area as a result.

After the beginning of the new year Bits from Bytes was acquired by 3D Systems. I attended the telephone meeting announcing the takeover and was so put off by the 3D Systems CEO, Abe Reichental, that I abandoned any plans to purchase any more Bits from Bytes equipment at all.

That left me with quite a dilemma. I had never been particularly happy with the Mendel design. Tommelise had used very similar kinematics. The problem with it that it requires a larger footprint than the print table and is unstable in the x axis direction. Mendel addresses this last issue with a

electronics mounting board that doubles as a reinforcing plate to cure the x-axis problem.

Because of that, I decided to stay with the Darwin kinematics and run the system through another kaizen exercise.

Basically, I want to look into several possible improvements to my Rapman

- a return to printed parts. My experience has shown that laser cut acrylic does not make for a robust machine.
- a massive reduction in the variety, as opposed to the number, of parts needed to construct the machine.
- parts design which allows for easy partial demounting of the printer.
- a design robust enough to be easily shipped fully assembled or quickly broken down and reassembled for exhibitions
- room for two extruders without compromising the size of the print table.
- cleaner y and z axis kinematics
- a more capable controller board
- shifting to the successful Wade/Adrian pinch wheel extruder

My experience with trying to install the Chylld corner on my Rapman has caused me to want to rethink the whole issue of parts design for a Reprap printer. I feel that we have, in a way, gone wrong when we designed the parts for Darwin and Mendel. Because you can custom tailor individual parts with a 3D printer doesn't, to me, mean that it is good design practice. Right now, to have a proper set of spares for a Darwin or Mendel you pretty much have to print a full parts set. A lot of that stems from, in my opinion, from custom tailoring parts.

I don't think too many Reprappers are going to bite the bullet like Adrian Bowyer and Nophead {Chris Palmer} have and print whole sets of parts day after day and week after week. Most of us want Reprap machines so that we can design and print other things beside new Reprap machines. To that end, having a limited set of parts types that you can print a few at a time during down time when you are doing design, seems to me to be the way most of us are going to propagate more printers.

With respect to a new y and z axis design I want to revisit the cabling approach that eD did with the Darwin precursor ARNIE back in 2006.

But, enough talk. Here is what I have so far.

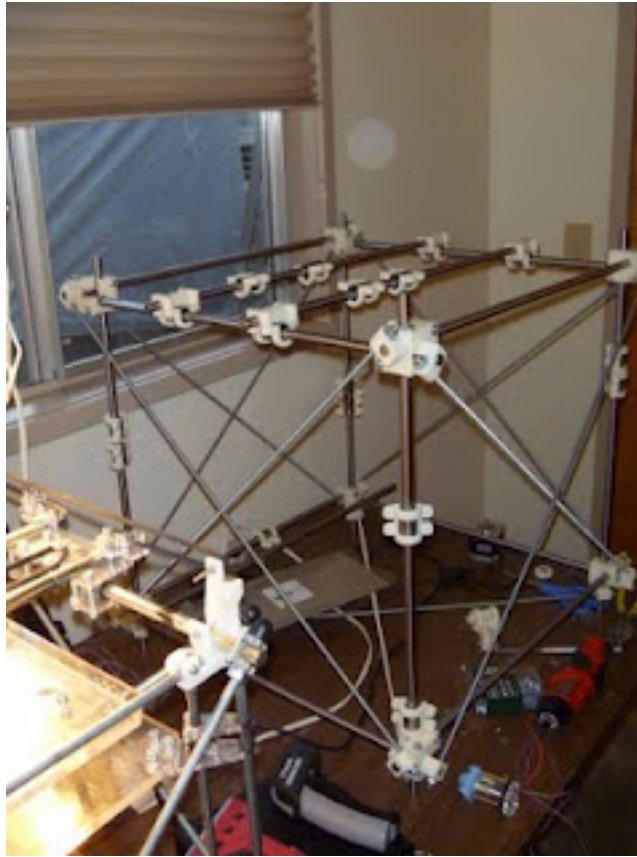

Sampo's frame is built on a 600 mm module to give it that extra space for dual extruder print frame that Rapman's 400 mm does not. So far, the entire frame has been assembled with exactly five different parts.

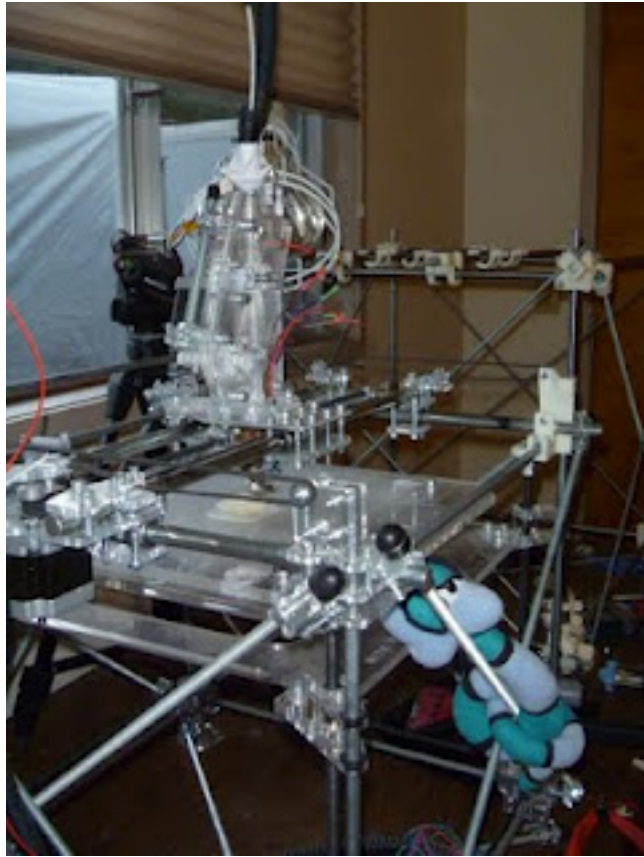

Here you can see the Sampo frame beyond my Rapman 3.0 for scale. I am working on the cable housings for the z-axis as this blog entry goes to press.

3D/DC

Monday, 2nd May 2011 by Wade Bortz

I had a great time down at the 3D DC event last week. It was organized by Michael Weinberg of Public Knowledge; the purpose was to educate the US government about 3d printing and personal fabrication, in an effort to try and avoid repeating the legal mess that has embroiled the music and video industries. Lots of interesting folks there, some superstar hackers, and even free beer at the end! I put up a few photos here:

<http://gallery.me.com/wbortz/100179>

and what follows is a more detailed account of how it went down. Enjoy!

Wade



I was a bit concerned when I first met Andy.

He had mentioned via email that his RepRap could use a little tuning up before the 3D DC event, so we arranged to have a little meet up in the garage of my dad's old college room mate Dick, at whose house I was staying in while in DC.

Andy, a young guy who works at the Baltimore FabLab, turned up with a box (a very nice box with a huge RepRap logo engraved on the front) of assorted electronics and RepRap parts, and a three day old Prusa Mendel with no electronics, X carriage, or build surface, in a state that looked to me like it would take several days of work to get it anywhere near it's first print. The event was the next morning, so we got to work, assembling testing, tweaking, hacksawing, and wiring.

For someone like me, used to the original Mendel (and Darwin before that), it went together surprisingly quickly. We were doing test prints by 11 pm, when I had to beg off and get some sleep, being quite jetlagged. Figuring that we were close enough at that point, and besides, we had my Mendel ready to go €“ the Prusa was really a backup, a 'nice to have' extra, so we (well, I did at least) figured sleep was more important than a perfectly running pair of RepRaps.

Arriving at the Capitol the next morning our large, wooden, wheeled crates raised a lot of eyebrows from security and congressmen/women alike. As we set up in the foyer of the Rayburn House, directly South of the Capitol building, we immediately hit a few snags €“ Andy's computer's screen went dark. It would only flash briefly at boot, but then stay completely dark, despite much swearing, prodding and pounding. Bad timing, but no problem; we still had my Mendel.

Unfortunately, despite almost year of reliable service, my extruder (a Wade's Extruder of course, something I'm fairly proud of) chose that moment to jam up. Hmm. After a quick on-site disassembly and cleaning, and not so quick reassembly during which I had ample time to reflect on the poor design choices I made in the mounting arrangement of my extruder, I got it running again, only to have the extruder heater short out repeatedly at 70 deg C. Oops. Should have finished that resistor based extruder. At this point another exhibitor mentioned something about an unusually high gremlin population here at the Capitol...

By this time it was time for the panel meeting, so we adjourned upstairs to listen to a fairly interesting panel talk. The point of this entire event, organized by Michael Weinberg of Public Knowledge, was to try and expose the US government to 3d printing and personal fabrication. Existing copyright law and how it relates to things like the Internet and file sharing could be considered one giant legal mess; the Public Knowledge guys were trying to get a head start on how digital fabrication is going to be received by the American legal system, in the hope that some of the pitfalls that are looming may be avoided.

Lots of interesting points were brought up about IP, trademarking, lawsuits, copyright etc, but not much in the way of solutions just yet. It was entertaining to see Bre up there in his black t shirt among all the suit and tie folks. Everyone agreed that something should be done, but what exactly that something was, no one was quite sure. Except for Bre €“

he was quite sure what needed to be done €“ get more printers out there ASAP, and make more stuff. His enthusiasm was, as always, contagious, and really put a positive spin on the event. Good times! I snuck in a blurry cellphone photo of the panel members, but since I could see 6 expensive looking CCTV cameras looking at me, and a lot of large security guys looking around purposefully, I didn't think taking a proper photo was appropriate.

Back downstairs, Andy, after a few quick google searches, ruled out memory problems on his laptop, and figured out that the backlight had failed. We tried downloading his host software onto my laptop via my Canadian cell phone, in order to run his Prusa off my laptop, but AT&T didn't seem to like the 13 MB file and wouldn't give us more than a kb/s or two, unlike the 100's of kb I usually get back home, despite having signed up for a temporary US data account.

Thinking quickly, Andy used my flashlight to see small portions of his computer screen, just enough to get his host software running and started up a print €“ awesome! People starting filling in at this point for the hands-on demonstration, so Andy took the helm, showing off his 3 day old machine, proudly printing away, while I smiled, answered questions, and madly re-wired my extruder's hot end. Luckily, I got it running fairly quickly, and we had two RepRaps running smoothly to show off. We were both very happy campers, and had a chance to mingle with the rest of the attendees, and answered many questions. I passed out a few gears I customized with my email address in lieu of a business card, and everyone loved the set of Heart Gears I'd printed out from Thingiverse.

I was amazed at how many people understood immediately the concept of how RepRap prints itself, but then I realized this was a pretty smart crowd, and that I actually had a banner in front of me that spelled it out in big, easy to read letters: "RepRap €“ the 3D printer that prints itself". Right. That really made things a lot easier, much less explaining to do on my part than last time. A few people even picked up the handouts, and a couple of them looked like they might actually read it. Quite a few people asked me why my partner kept shining a flashlight at his computer screen €“ they thought he was up to something funky like the guys doing free-form printing via a hacked Kinect at the next table over.

After much printing, looking at printers printing, and fondling cool printed objects, it was time to wrap things up and head out for free beer (really! free as in beer!) down at the Pour House, where I was able to spend a good bit of time talking with Michael Weinberg, along with a lot of other great folks. Michael, who put the whole event together, was extremely pleased with the event. Apparently, in addition to all the 3D printing folks that showed up, almost all of the people from the Patent and Trademark offices and other government types that he was gunning for had shown up as well, so he felt we had really accomplished something. If he was happy, I was happy, so all in all, it was a good event!

I also met all sorts of RepRap luminaries I'd only ever met on IRC before, including DrGone, Dr Mark Ganter, and the newly renamed DigitalWonderBoy (Andy!), as well as Jeff Moss, the founder of DefCon, the yearly hacker convention where everyone plays the game "Spot the Fed". All in all, it was a very fun, successful event. Although, I must admit, after shlepping a full Mendel across several airports and a few public transit systems, I suddenly have a renewed interest in the Huxley.

A big thank you to Bath University for paying my way down to DC for the event, thanks to Dick and Helen Podolske for providing a roof over my head and a garage to tinker away in late into the night, and Adrian and the rest of the

RepRap community for making this all possible. And thanks to Andy Ta for helping out €“ it was really fun, and I'm really glad you were there with your working RepRap!



Thermal goodness

Sunday, 8th May 2011 by prusajr

I managed to get some thermal images of my Prusa printing Buddha. I put them on my web and commented them. <http://josefprusa.cz/thermal-goodness>

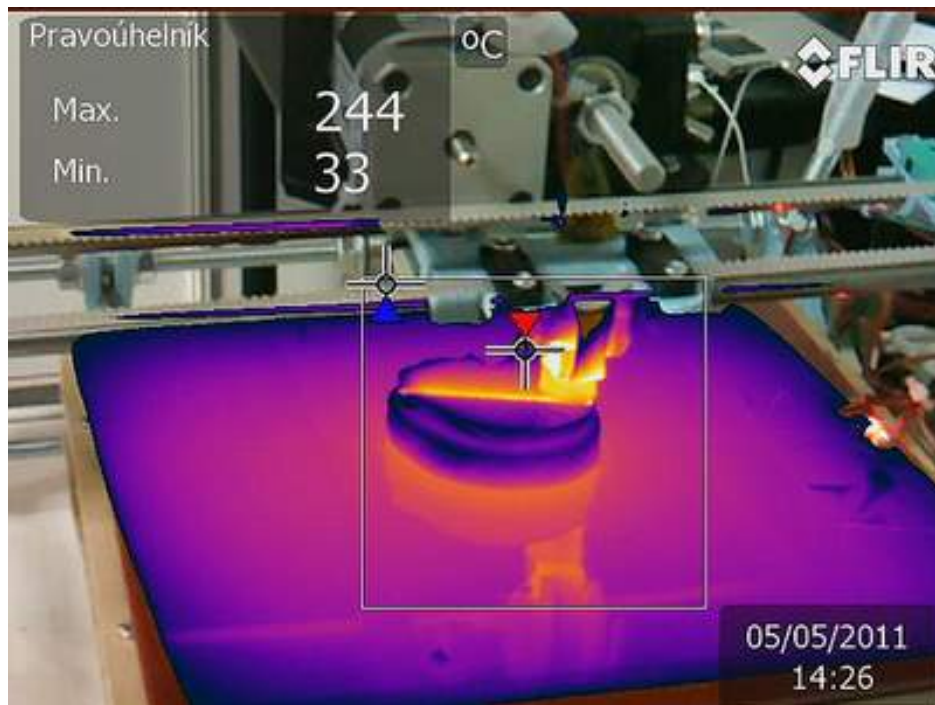

Solid prints

Monday, 9th May 2011 by Forrest Higgs

Printing solid, structural objects is quite an art. As I mentioned earlier, I am harking back to a very early effort that eD made with A.R.N.I.E, the precursor to Darwin. eD wanted to use a cabling system for several of the axes not unlike what you used to see for parallel bars on traditional drafting tables. eD finally gave up the effort when he couldn't get the cable to grip a sprocket wheel properly. I have another idea about how to do that which I will talk about in the near future.

Securing the cable and pulleys for the z-axis is tricky. I've spent quite a few days designing a lower corner mounting block for the pulleys.

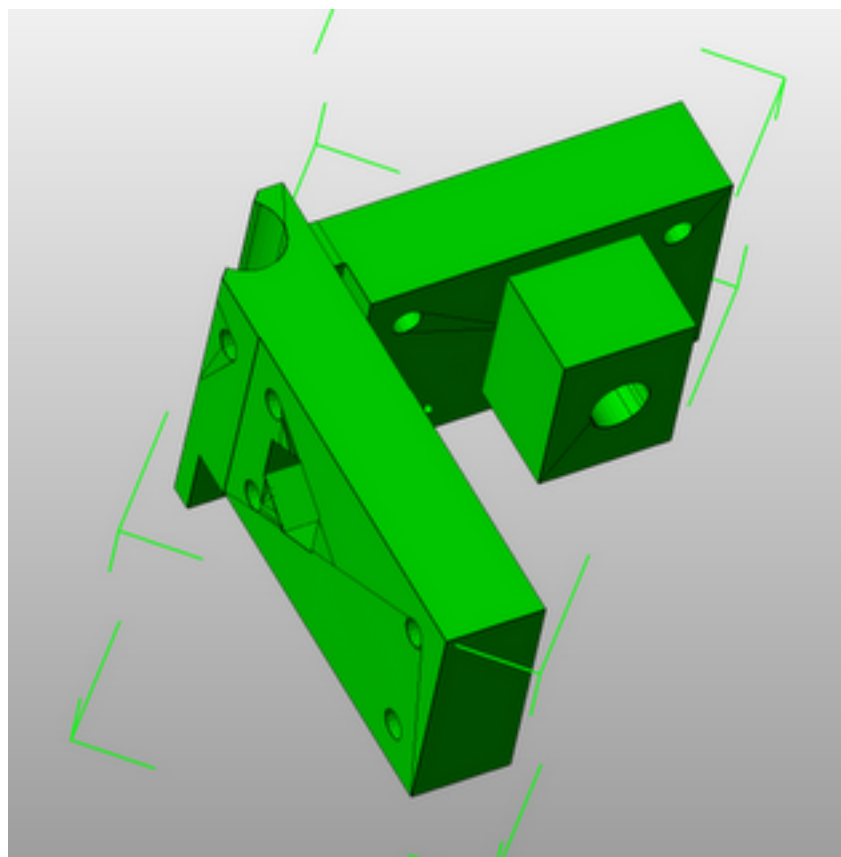

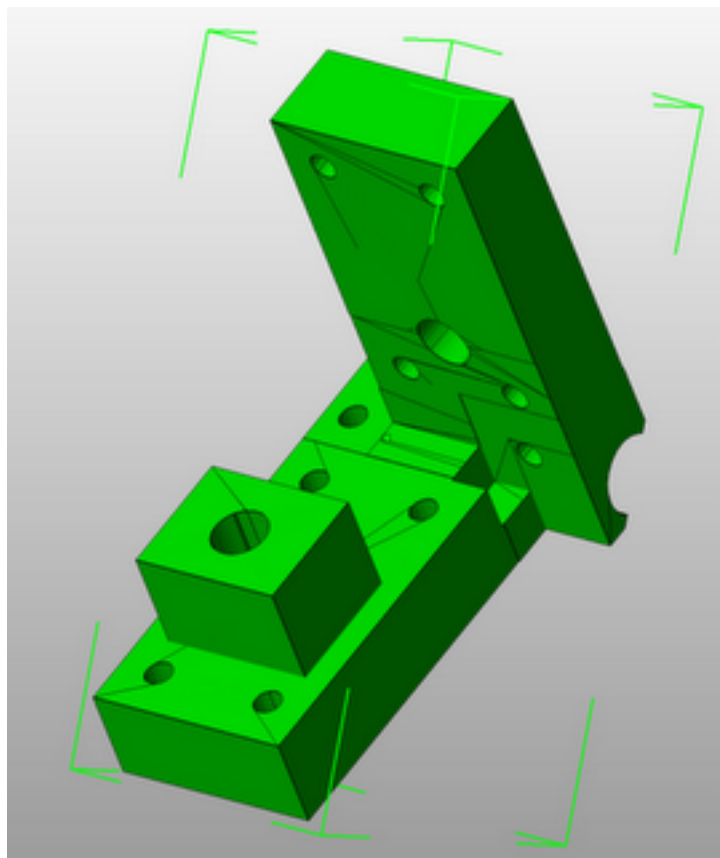
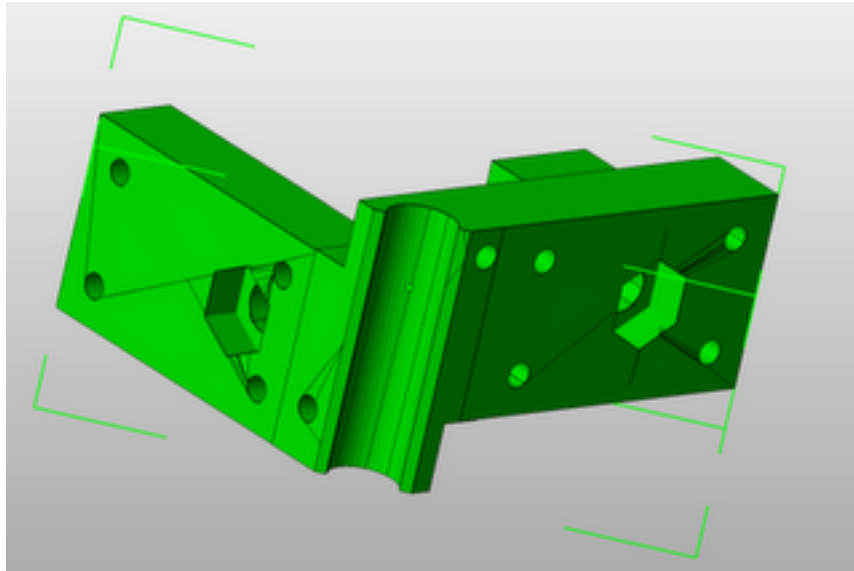

At 69 cubic centimeters it's quite a large piece. One thing you learn very quickly is that when you are designing structural pieces you have to remember that you not printing an isotropic material but rather a grained material not unlike wood. As a result of this, it doesn't do to lay this block on one flat surface. That gets you a part that is strong in one plane and fatally weak on the other. Given it's size that's asking for corner curling in any case.

As a result, I decided to put the grain of the print at a 45 degree angle to both major planes.

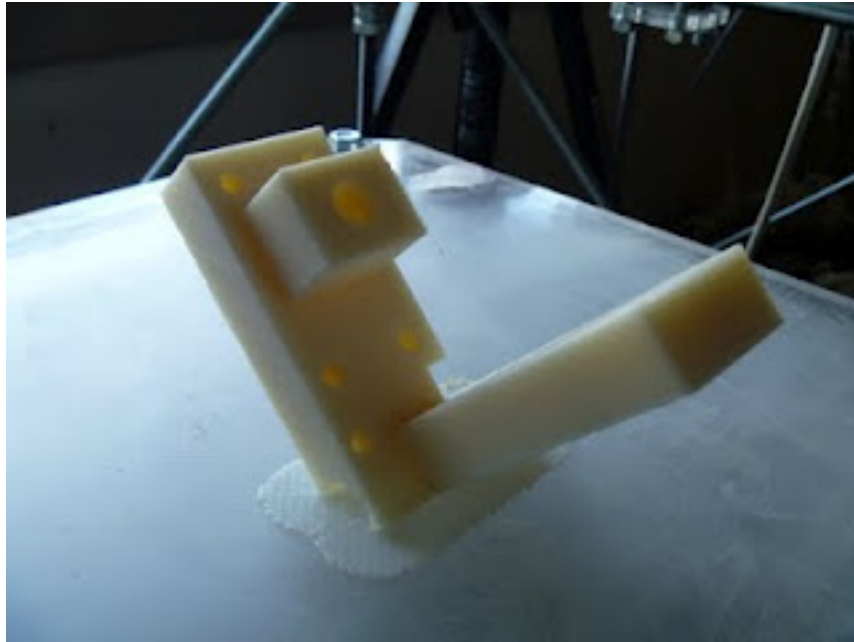

Several tries at printing it finally got me settings that yielded a very clean, handsome print. The preparation time for this piece was about 20 seconds after I removed it from the print table.

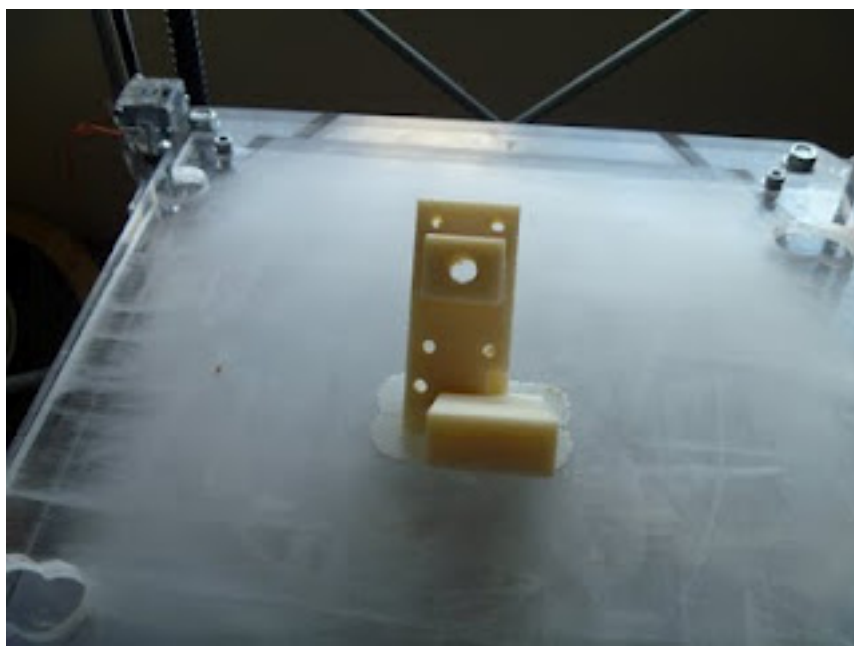

You can see how clean the bolt holes are.

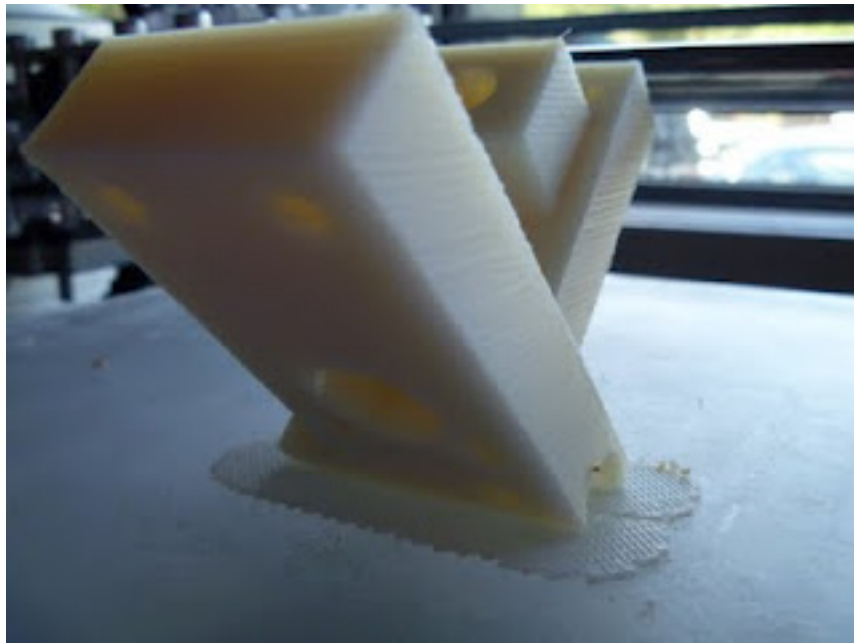

As are the recessed pockets for the hex head 5/16ths inch bolts. No warping. No corner curling. Pretty much a perfect print. The longest dimension is 80 mm.

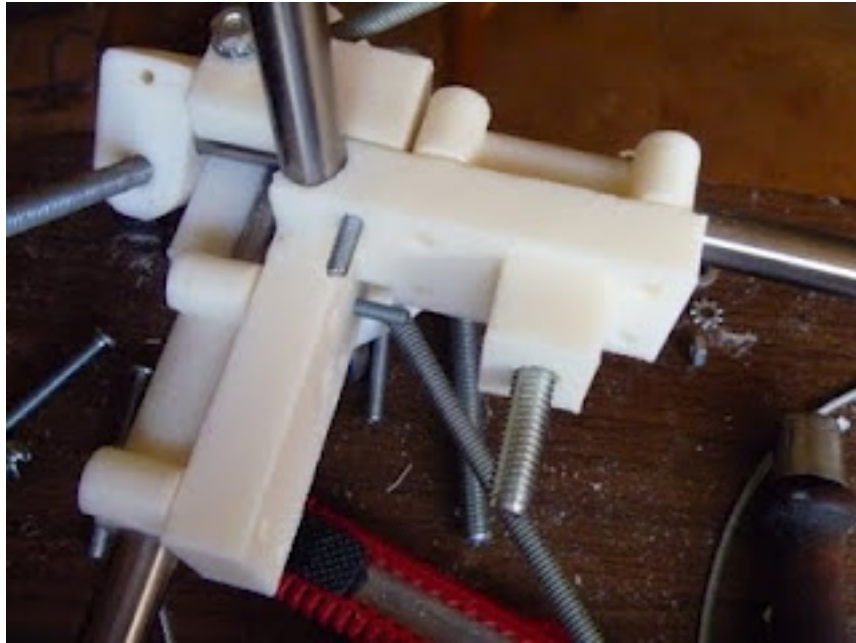

The part mounted properly without problems.

Refighting the String Wars.

Sunday, 15th May 2011 by Forrest Higgs

Back at the beginning of 2006, before there was even a Darwin, eD Sells at the University of Bath was designing Darwin's predecessor, ARNIE. Confronting the problem of designing a z-axis, eD adapted the kinematics that were used on old wire cable parallel bars found on drafting tables.



eD adapted this technology in 3 dimensions to allow a single stepper motor to raise and lower ARNIE's print table.

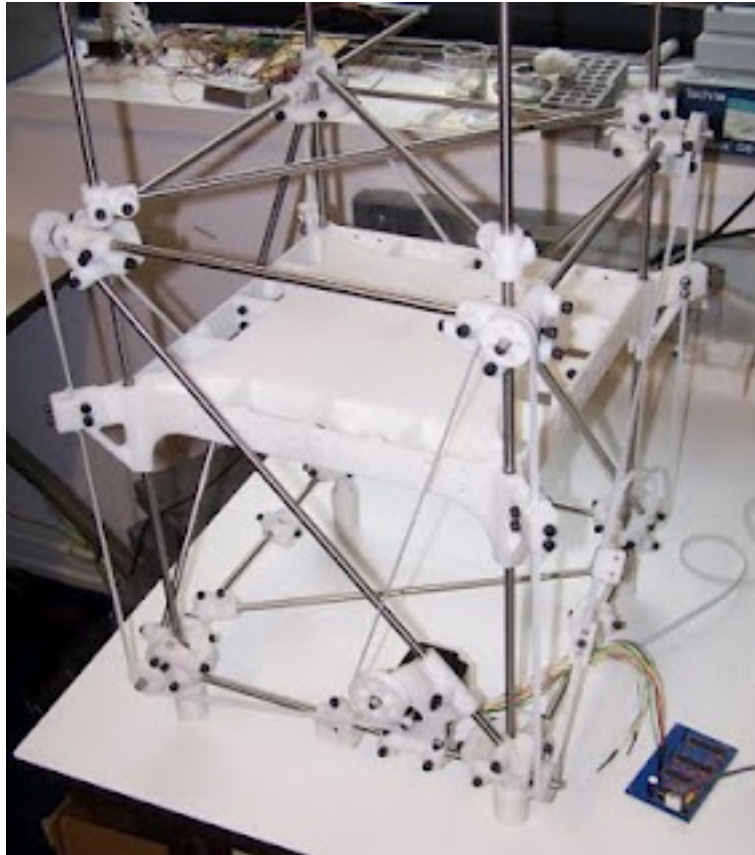

Having trained as an architect before the Great Flood, I immediately fell in love the idea and adapted it to my failed Godzilla Repstrap design.



eD encountered no end of trouble with the cabling idea and eventually abandoned it for an approach which used four pieces of studding {threaded rod}.

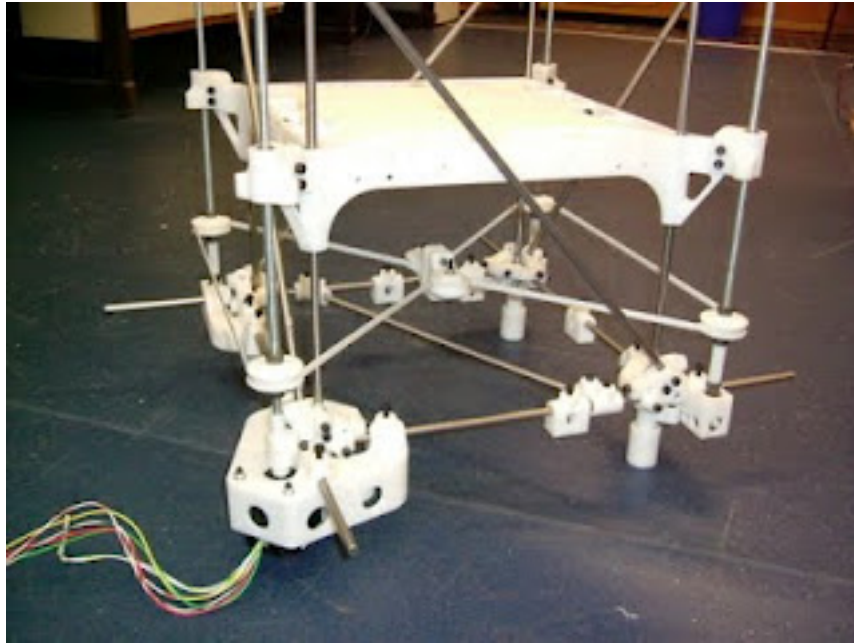

It tends to be forgotten but the first fully operational Reprap machine at Bath was ARNIE, not Darwin. Indeed, Bath's traditional whiskey shot glass, the second one printed after Vik Olliver's in New Zealand, was printed on ARNIE. This approach was refined in Darwin.

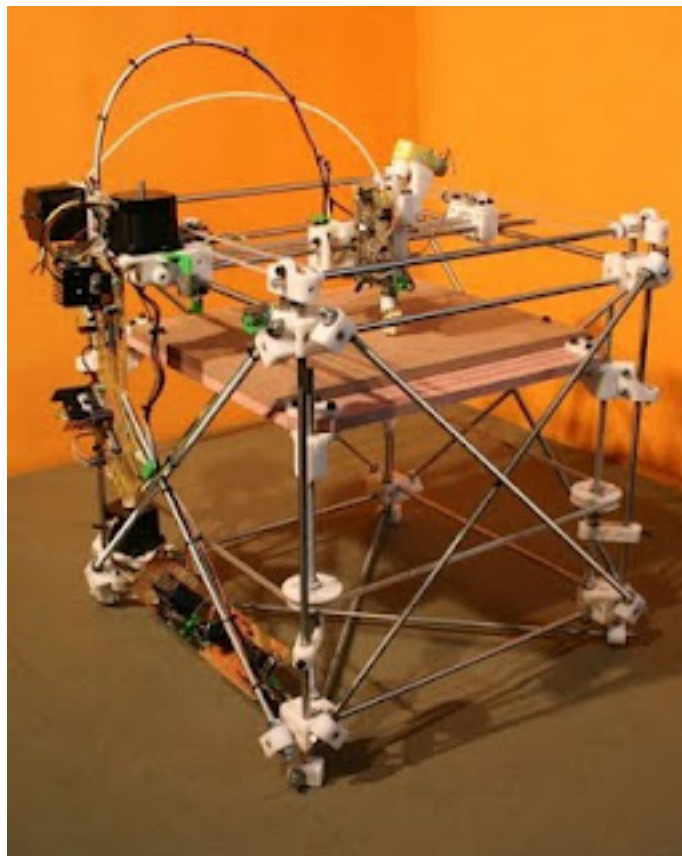

Rapman, a Darwin derivative, was put into serial production by Bits from Bytes and is still selling quite well, today.



This z-axis approach does have its problems, though. Studding is most definitely NOT a proper lead screw. When you undertake to use four pieces of studding to raise a 3D printer's print table, the tendency of studding to be not quite straight plus the fact that you are using four pieces of not quite straight studding can lead to some unpleasant consequences. Here is an extreme example of what can happen.

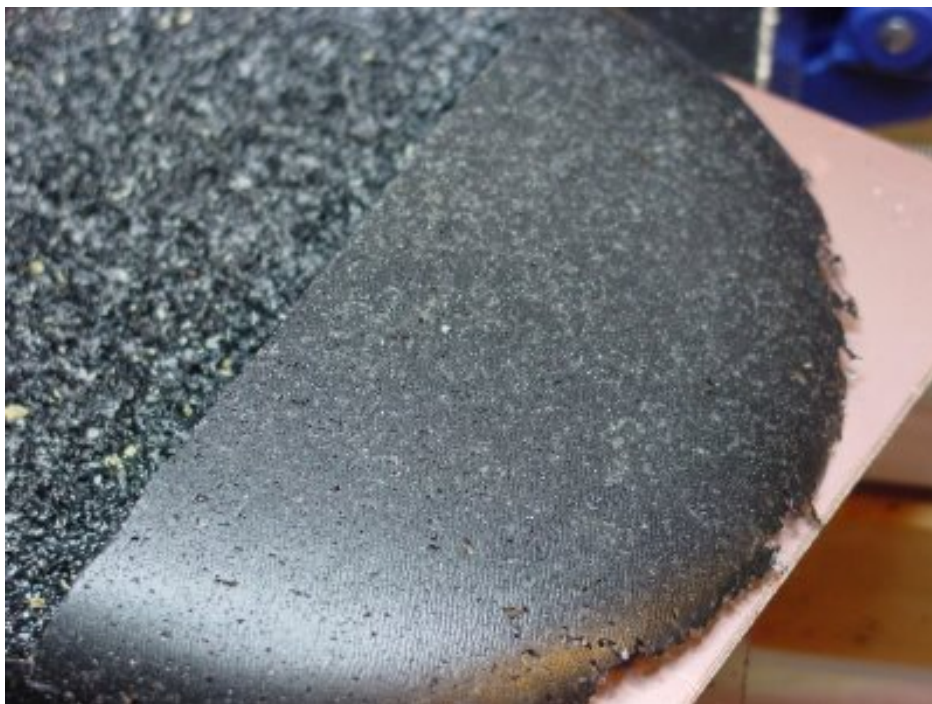

If you expand the pic, you can see a nasty juddering of layers taking place. Here is a more usual example of the effect.

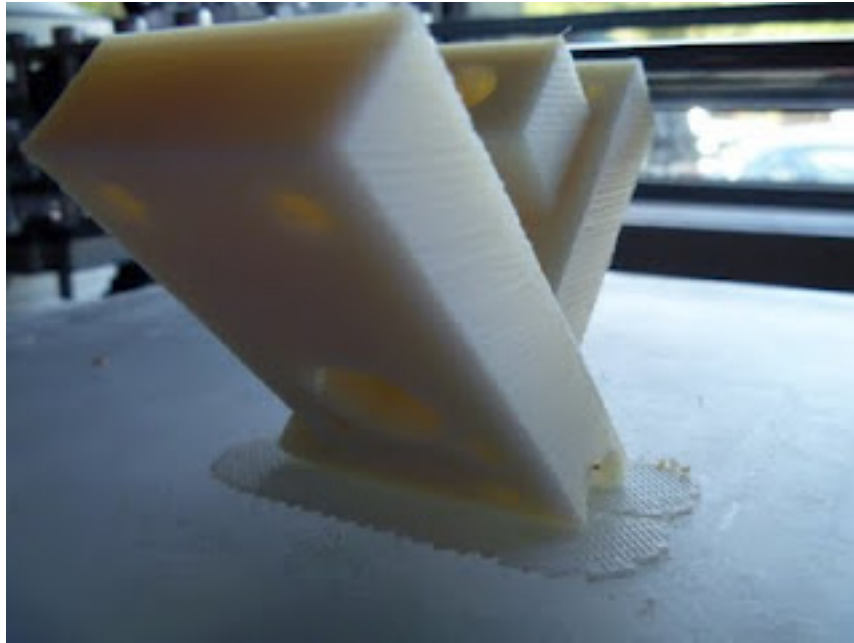

This is an extreme closeup with the light accentuating the effect. The object is quite smooth to the touch. The effect is still there, though. Here is a more usual picture showing the effect.

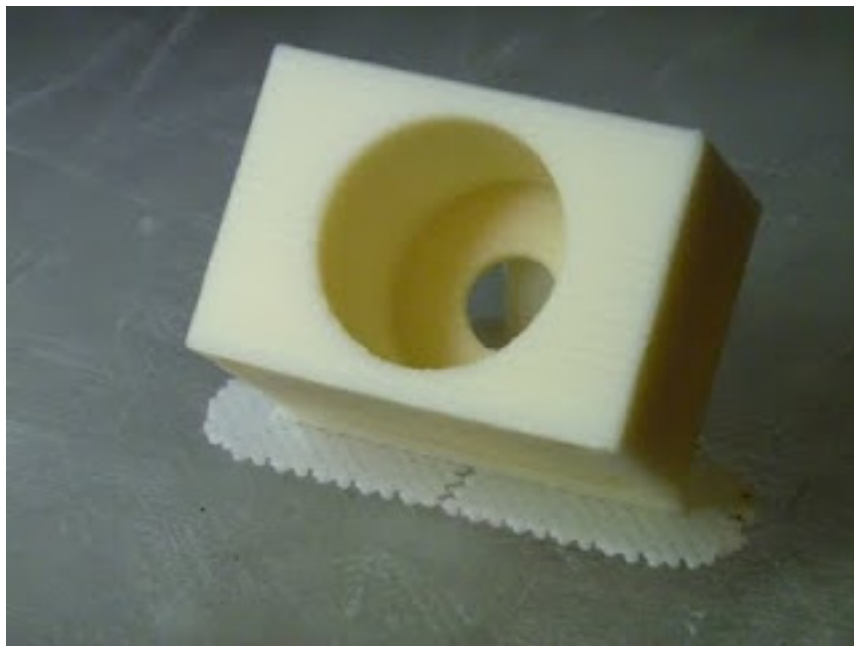

If you expand the pic you can see a regular pulse peaking at every seventh layer. This varies depending on how you adjust your machine and how straight your studding rods are. The closer the alignment, the better your print quality.

Now Bits from Bytes set out to solve this problem in their out-of-the-box BfB 3000 printer. They used a single proper lead screw to drive a cantilevered print table.



Both the Ultimaker and Makerbot's Thingomatic use the same approach.

Recently, when I decided to kaizen the old Darwin design, I decided to see what I could do about the z-axis situation. I didn't like the cantilevered print table approach and I did not want to simply duplicate the 4 studding solution originally used. That got me to thinking about the old cabling approach that eD had used back in 2006. The problem with it seemed to be applying force to the cable to move the print table. eD tried to use a friction wheel and eventually gave it up.

It occurred to me that it might be reasonable to use a single studding lead screw to apply force to the cabling. Lead screws can apply LOTS of force. So why not just attach one to the cable at a convenient point and be off?

I am in the process of doing just that.

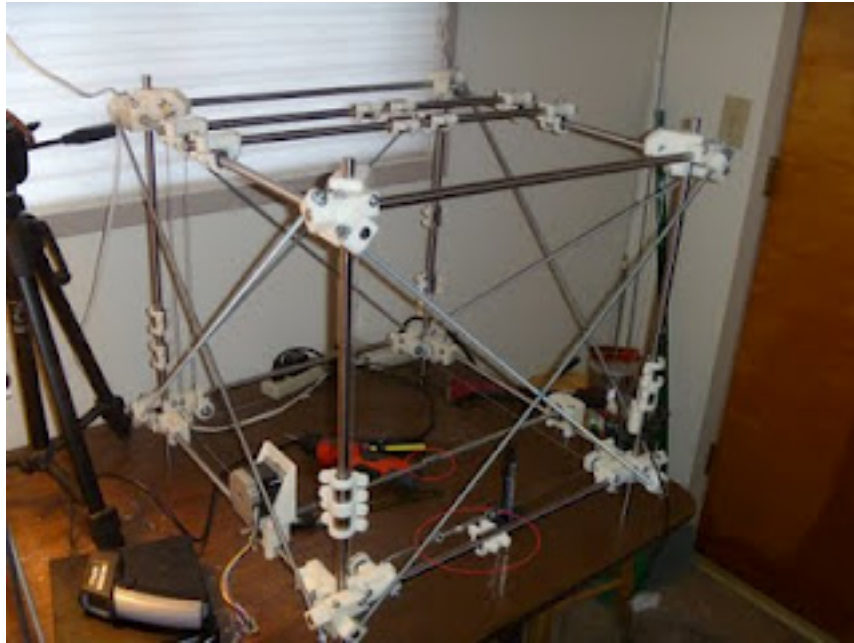

I have circled the lead screw's thrust collar, the cabling turnbuckle and a linear bearing. Those three elements will be connected and a NEMA 23 stepper used to drive the cabling to raise and lower the print table.

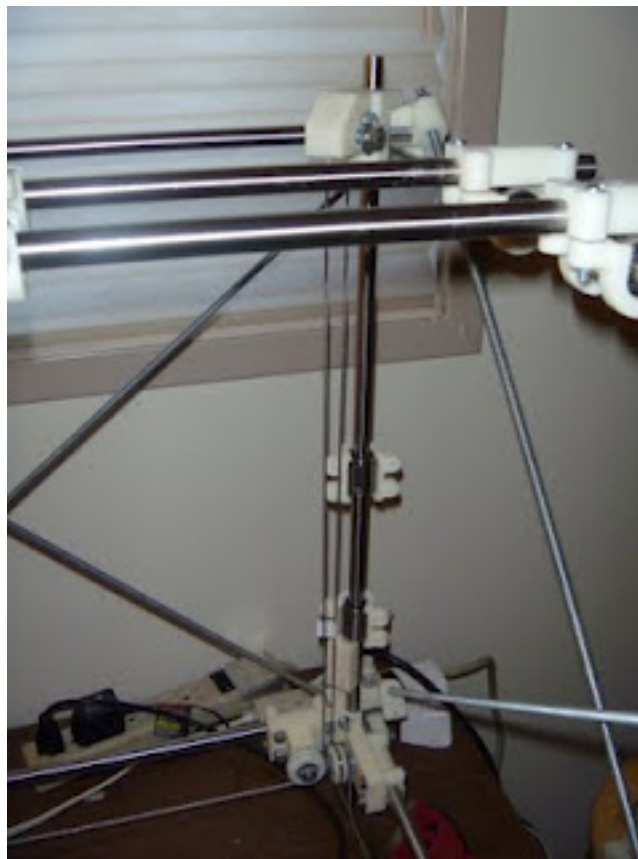

Here you can see a detail of the cabling scheme associated with a pair of linear bearings on a vertical shaft. I have got to design a connector between the cable, the linear bearings and a corner of the print table. Hopefully, this approach will let me get a smoother z-axis operation without the juddering so characteristic of the Darwin design.

Baltimore RepRap Master Class

Sunday, 22nd May 2011 by Neil Underwood

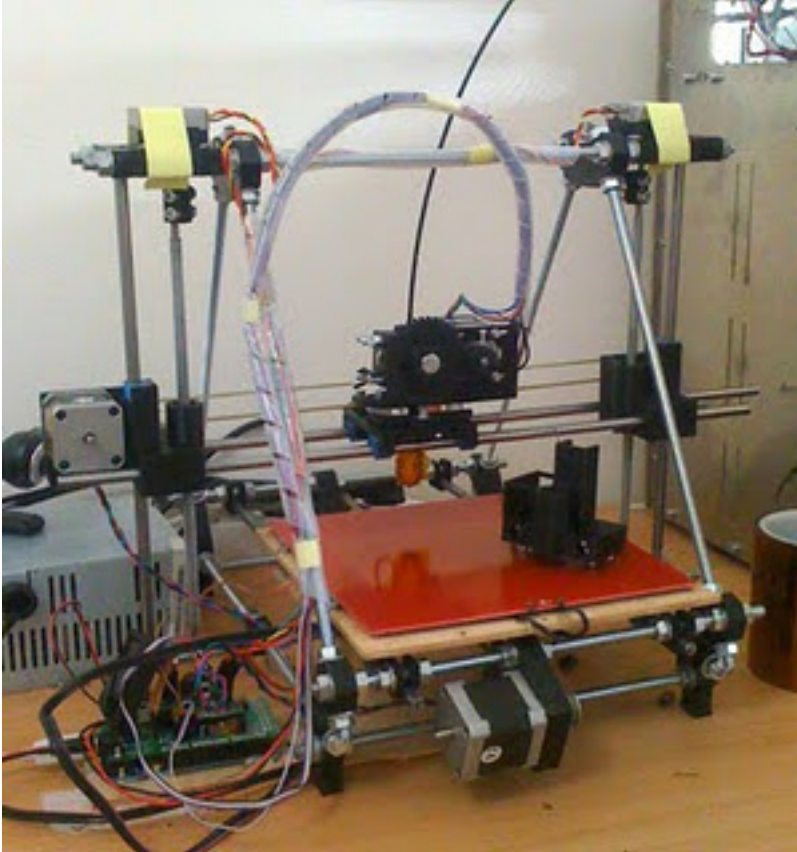

If you're thinking of getting into 3D printing and don't know where to start, then we have just the ticket for you. FabLab@Baltimore is holding a RepRap Master Class. The format is simple. For a fee of \$850, participants will be provided with all of the hardware and software, along with expert guidance, over the course of the weekend, to build and commission their RepRap 3D printer. There are other ways to get a one of these machines functioning, but these involve substituting cost with lots of time spent researching, sourcing and learning to get the best out of a RepRap 3D printing machine.

The Master class will be at the CCBC Campus, with the long time RepRap developers Jmil (Jordan Miller), Telsa893 (Steve Kelly), and digiFab (Andy Ta) among others.

For more information and to sign up, go to the [DigifabIndustries Website](#), or email [Andy Ta](#). We look forward to seeing you there this June.

Winding up the String Wars

Tuesday, 24th May 2011 by Forrest Higgs

I was finally able to finish making the connection between the z-axis lead screw and the cable turnbuckle for the z-axis positioning system. Given that the 3/8-24 threaded rod moves 0.945 mm per full turn and that the 32:12 gear reduction coupled with the 200 step/full turn for the NEMA 23 we get something like 533.33 steps per turn or 0.00177 mm movement per step.

You can see the general layout of the z-axis lead screw with this pic...

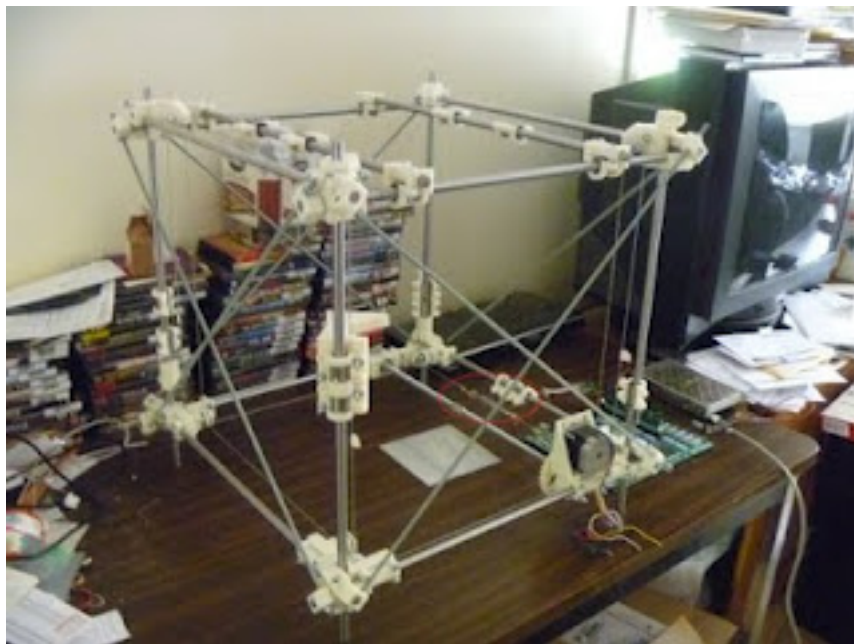

I've circled, from left to right, the thrust collar nut, the cable turnbuckle and the linear bearings that make up the elements to transfer power from the stepper motor to the cable.

Here you can see the three connected...

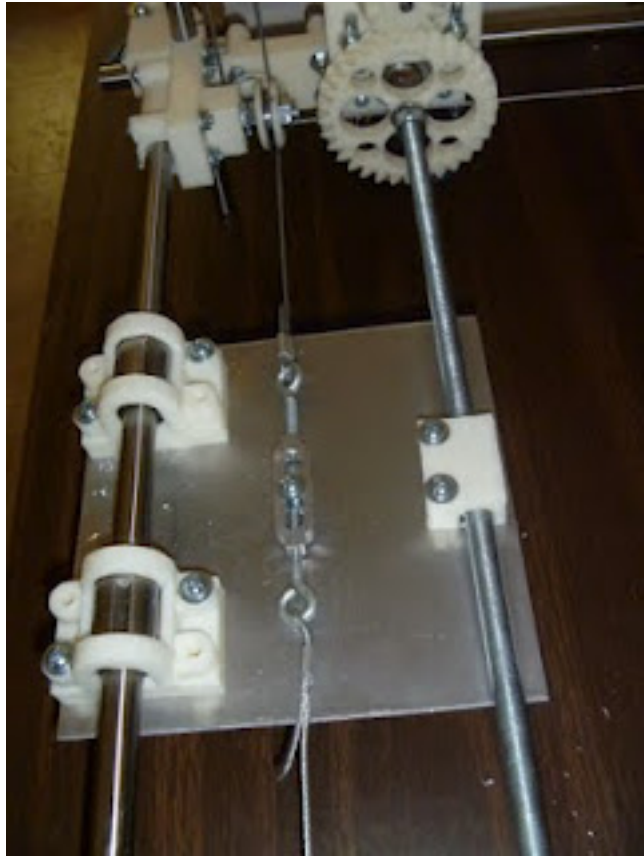

Here is a detail of one of the four cable-driven lifts for the print table with the bracket in place...

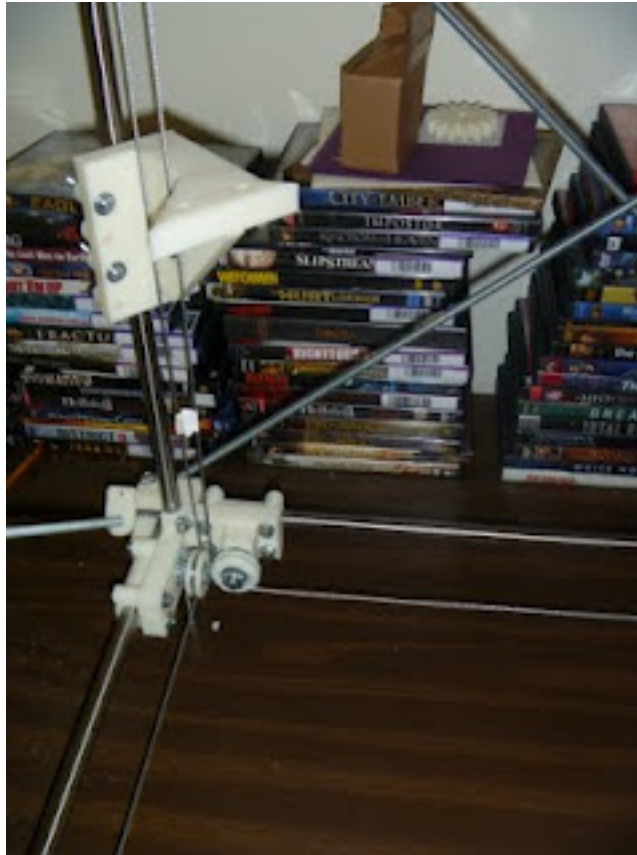

I plan on having one fixed joint between the brackets and the table and two sliding joints constrained in the x and y-axes in the two brackets adjacent to it and a sliding joint in the xy plane opposite. I hope that will be stable enough.

Next, though, I have to see if I can finish the design and printing of the BfB hot end adapted Wade extruder derivative. If that takes too long I will fall back on the two full BfB extruders that I have in stock.

Selectively making parts of object stronger

Wednesday, 25th May 2011 by prusajr

I've published small hack how to make some parts of object stronger then the rest :-)

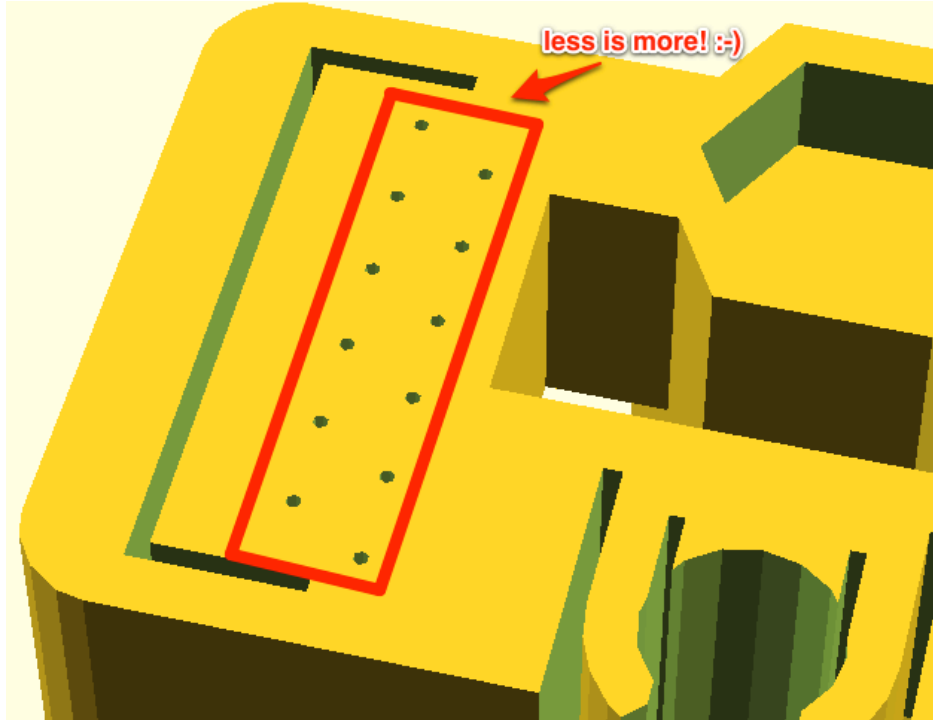

Selectively making parts of object stronger on RepRap with Skeinforge

Enjoy

- Jo Prusa

Moving RepRap from Subversion to Git

Sunday, 29th May 2011 by Adrian Bowyer

Kliment, Nils and Sam have got a daily copying from the RepRap Subversion repository to Git at <https://github.com/reprap> running.

This is a temporary arrangement to make the migration of RepRap from Subversion to Git easy for people - they can still use Subversion, or switch, and both repositories will be (roughly) synchronised. For the moment Git is the read-only slave, and Subversion is still the master where updates get logged.

This will continue until Wednesday the 6th of July. On that date we will freeze the RepRap Subversion repository and the RepRap Git repository will become the master distribution. That will then be directly updated (and, doubtless, expanded). The frozen Subversion repository will be maintained for the foreseeable future for reference.

Now would be a good time to update RepRap Wiki pages (and others) that point to parts of Subversion to make them point to the equivalent parts of Git...

Stepping into firmware

Sunday, 29th May 2011 by Forrest Higgs

Having had good experience with the Rapman's PIC32-based controller, I decided to stick with that MCU for my new printer. As I mentioned earlier, rather than buy a \$1k+ C compiler from Microchip, I bought a much less expensive, full-featured BASIC compiler for the PIC32 {they also offer C and Pascal compilers} and a full development board from Mikroelektronika in Belgrade.

Friday night, with the last of the z-axis brackets being printed on my Rapman and the 19 June exhibition in San Francisco coming up, I decided that I'd better get cracking on the firmware.

When I bought the PIC32 development board from Mikroelektronika, I also picked up a little stepper controller board from them.



It uses an Allegro A3967 driver chip rated at .75 Amps. Now ordinarily I wouldn't have considered getting such a thing, but in this case it seemed reasonable to have a ready made stepper tester board that I knew worked with my development board and I knew I had a number of small stepper motors that I could use with it. Nothing I'd consider using on the printer, mind, but all the same useful in the learning process.

Like Darwin and Rapman, I'd decided to be conservative and use NEMA 23 steppers. The price on these has dropped dramatically since we were building Darwins several years ago. While shopping for NEMA 23 steppers, I happened across this little jewel.

We knew very well that we could get a lot better performance out of steppers if we used 24 volts, but nobody wanted to invest in a 24 volt supply. This bad boy put out 6.5 amps at 24 volts for \$19. The economics of that were hard to argue with given that my development board power conditioning circuit would eat anything up to 30 v DC.

Friday night and Saturday I spent the necessary hours skating down the learning curve of the Mikroelektronika development board and compiler IDE. This took longer than it should have in that the PIC32 boards and compiler are very new to Mikroelektronika. As a result, while they had code samples in BASIC for their stepper controller board, they were for 8 bit PIC chips and development boards, not their new 32 bit offerings. I don't know why firms don't offer extremely simple sample code patches. Instead, they always clutter it up with nonsense that runs LCD boards and makes LEDs flash on and off prettily. Of course, how that works on an 8 bit board is very different than it is for a 32 bit board.

By Saturday afternoon, I'd managed to unclutter and migrate their code to PIC32 and had the stepper controller connected to the NEMA 23 working properly.

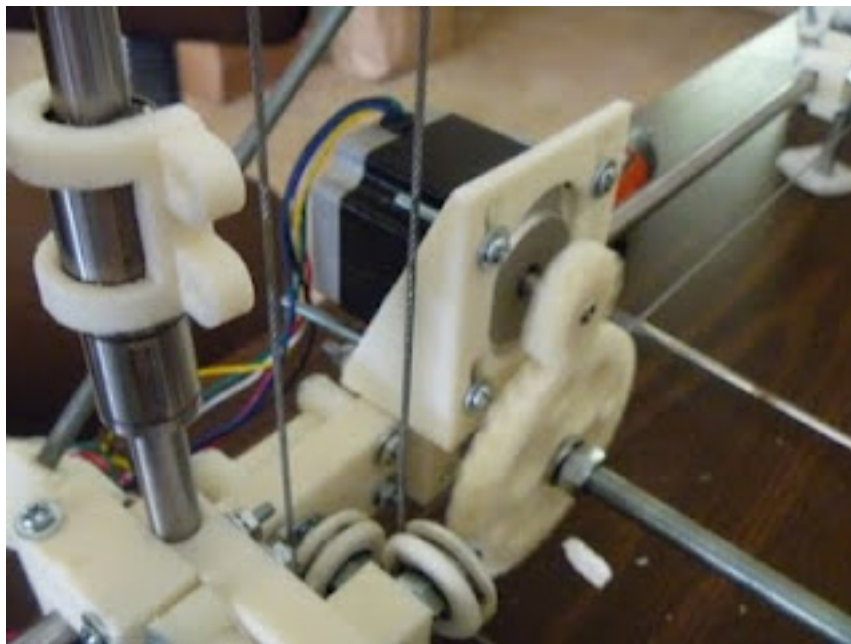

I knew there was a lot of friction in my cable z-axis system, so I did an initial gear design of 3.5:1 to insure that I got plenty of torque. I had rigged the 6 wire stepper in series at Bogdan's suggestion so that the amperage pull was considerably below 0.4 amps. Imagine my surprise when I discovered that there was ample torque even at half-step to happily push that stiff z-axis lead screw collar back and forth under serious load at 660 pps, a step rate just short of the resonance speed of the stepper. Even under those loads the controller chip never got above about 50 C even after several hours under load. That means that no heat sink is necessary. When you translate that pulse rate out to an MXL belt driven x or y axis powered by an 18 groove pulley you get a calculated top speed of about 60 mm/sec. That's about three times the head velocity that I print at. It would appear that running a stepper with 24 volt power makes a very big

performance difference.

Here you can see the stepper controller attached to the NEMA 23 and the PIC32 development board.

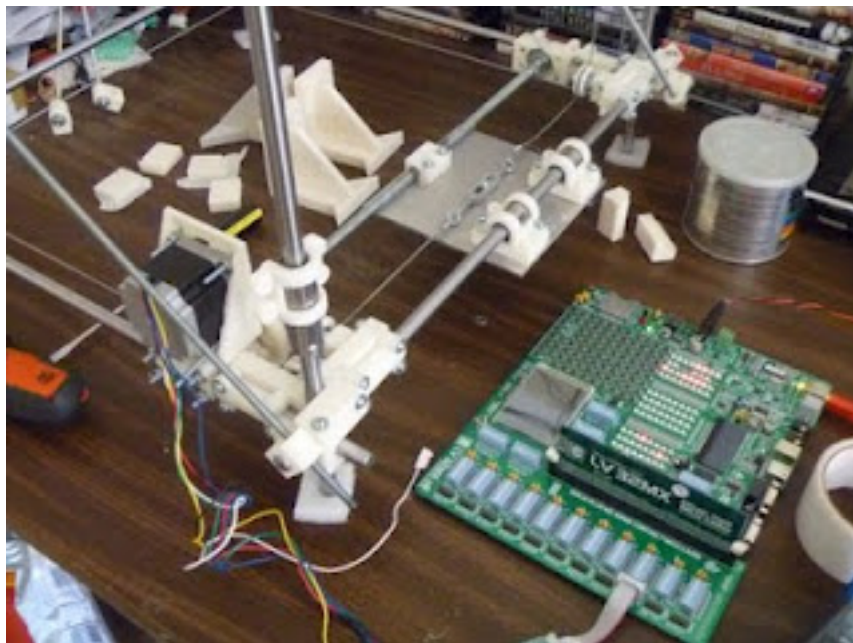

I've been thinking about that cool controller chip and that NEMA 23 and wondering about the possibility of driving a Wade extruder design with a NEMA 23. The technology and economics are certainly attractive.

I'm going to buy some more of those controllers and also a relay card so that I can control the hot ends and heat lamps on the printer.

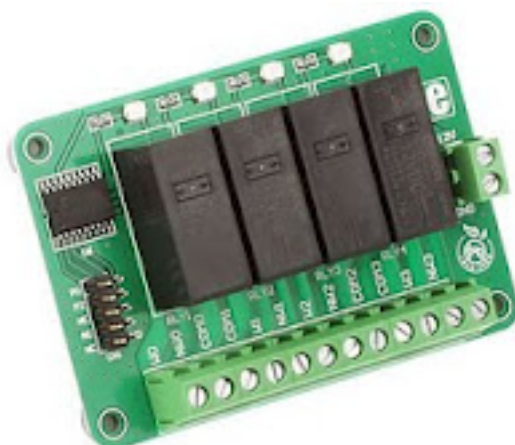

Mikroelektronika certainly has a very big toolbox of accessory boards that let you prototype just about anything without having to build up circuitry from scratch. They're not as cheap as you could build from scratch, but if you count the time and cost of building up purpose made boards while you are developing a printer and not sure of everything you want in it, they're very cost effective.

The end of the String Wars

Wednesday, 1st June 2011 by Forrest Higgs

It appears that the cabling approach to z-axis positioning that Ed Sells tried and abandoned on ARNIE, the precursor to Darwin, in 2006 can be made to work. Ed was trying to move the cable with something like a friction wheel, if I recall correctly and couldn't get sufficient friction between the wheel and the cable for reliable movement. I solved that by using a lead screw and thrust collar attached to the turnbuckle in the cabling loop.

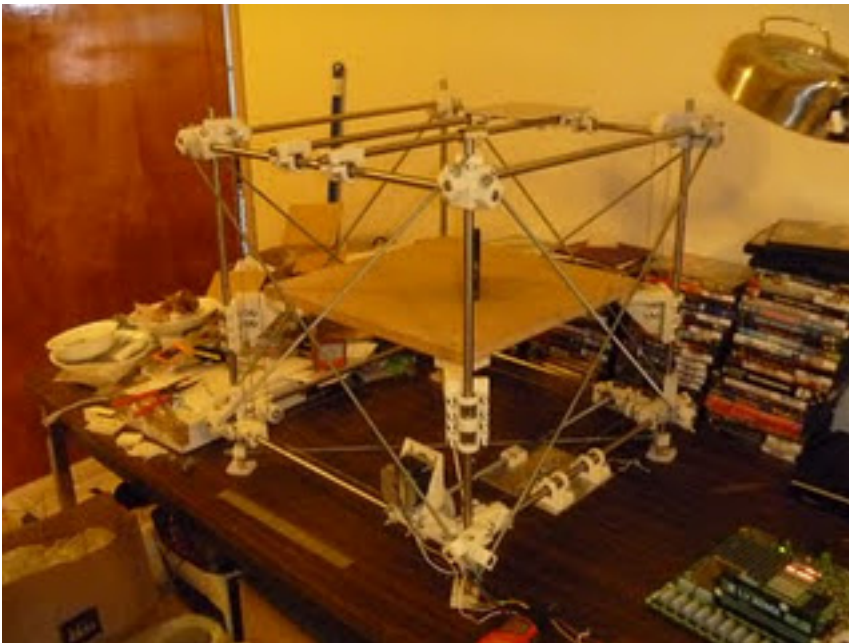

Hopefully the use of a single lead screw will go some ways towards curing the slight periodic unevenness in print layering caused by wobbling in the four leadscrews used in the Darwin and Darwin-derivative Rapman printers. Kaizen is a very powerful approach to technological advancement.

Unreasonable Rocket's 3d Printed Rocket Engine Takes Flight!

Sunday, 5th June 2011 by Neil Underwood

My two passions are Rocketry and 3d Printing. Paul Breed has combined the 2 in his test flight of a 3d printed stainless steel rocket engine.

To my knowledge this is the 1st successfully flown liquid fueled 3d printed rocket engine.

Paul Breed has a wonderful blog over at <http://unreasonablerocket.blogspot.com/>, you should really check it out, a lot of his issues with his 3d printed Rocket engine dovetail with issues we will run into as we use our parts for higher temp/pressure applications.

Prusa Felt branch and ThingDOC

Wednesday, 8th June 2011 by prusajr

So, if you are wondering whats new in Prusa printer development, I'll answer some of your questions today. And maybe even bust some myths ;-) First I want to show you results!



(Darker blue is print from Dimmension uPrint, Lighter blue is print from Prusa with felt bushings)

For more pictures and info follow the link on the end of this post.

New bushing look



In the same printed object you can use:

- felt (100 bushings for \$5 if you use best felt)
- brass tube (80 bushings for \$9)
- pla bushings (one prints in about 30seconds :-D)
- igus bushings (as Shapercube use, it's pretty expensive because of matching rods)
- sku bushings (steel with teflon inside, expensive because of rods \$50 per full set incl. rods)

All of this stuff remains snap in! So you can remove your carriage without disassembling half of printer.

During the big demand I will incorporate the possibility to use linear bearings too, but it will be few days after this release. And it's not going to be the main stuff. Simply because it's not better and sourcing is harder and pricier.

ETA to merging it to master branch is about two weeks. Catching last bugs out. And also, from this point, every commit will have its own ThingDOC documentation, which is under huge development during moving documentation to the files!

ThingDOC is now Ready for its prime time!



[For more informations, images and links, visit original post.](#)

Jo Prusa

Founder's Forum

Saturday, 11th June 2011 by Adrian Bowyer



My daughter, Sally, and I took one of our RepRaps to The Founder's Forum 2011, where I also gave a talk. The event is organized by Brent Hoberman, and so many thanks to him for the invitation. I wouldn't normally name drop, but you can get some idea of the event by the celeb end of the guest list (Stephen Fry, The Duke of York, Davina McCall...) and that fact that there *literally weremore* helicopters parked outside than Ferraris.

We shuffled our Ford Fiesta (complete with bat droppings on the bonnet from the roost in our garage) between a couple of Tesla Roadsters, lugged the RepRap machine to centre stage, and set it running.

Given the above, you won't be surprised that there were some top-end journos present too, so we got some good publicity out of the whole thing. Follow the links:

Rory Cellan-Jones and Robert Peston of the BBC (Of RepRap, Peston tweeted, "Real life better than Dr Who."), and

Ben Rooney of the Wall Street Journal.

Getting Rid of Mendel's Nuts

Sunday, 12th June 2011 by Vik Olliver

I've been working on something for a bit, and the results are starting to surface. I made a rash promise in the #reprap IRC on freenode.net to put up a teaser on Sunday, so here it is. It's a RepRap variant with no fasteners in the frame, using sockets to accept the (in my case) 9.4mm aluminium tubing struts. You can assemble it with my favourite tool - the mallet! So far the only screws are those needed to hold the motors, belts and extruder guts in place (though as the extruder isn't built yet so that ain't saying much). Holes are provided for adding glue to the structure, and for the particularly fastidious they can be drilled and tapped as well. I've even made the glue cavity the shape of an M3 nut so you can in theory make strategic joints releasable to aid portability if you really do like your nuts..



Um, ignore the basket of fresh clothes. Suz thinks the workshop is some kind of laundry. Even keeps the washing machine there.

The shedding of M8 rod has other advantages besides removing the need for many fasteners and making the whole thing lighter. A good one is that the frame struts can now be smooth enough to run the axis skids on - running a skid on M8 thread is a teensy bit like sliding down a grater. This removes the need for some lengths, lightening the structure still more. Make it from hunting arrow tubing and you'd be going featherweight. Use bamboo and go eco. Many options.

The design of the new Z axis hinges on the use of a Sarrus Linkage, ahha, ahha. I'm hoping something cunning can be achieved with a DC servo and string, but until then a NEMA17 and a piece of M3 threaded rod will do. No there is not a lot of Z travel in my quick bodge (unless you

count the slack when it wobbles up and down at present), but there is enough to get on with. The Sarrus is actually a great fit mechanically for the Mendel-style frame, because the Sarrus gets narrower as it gets taller - just like the Mendel's triangular profile.

The X axis is right at the top, and a one-piece extruder/carriage slides back and forth across the top two runners. I'm still coding the brackets and idler for that. Yes, coding. The whole thing is parametric. The Y axis is more firmly in reality. This is a cunning sled that pulls itself together with a couple of rubber bands. This causes the sloping faces of the runners to move up the side of the rod as they travel, until they hit the top. This kills wobble automagically and is remarkably tolerant of mis-aligned Y bars. It'll even work upside-down! The proper Y motor bracket is still being designed, so for mechanical testing I used fancy stuff called string...

The vertexes are going to change a bit from the picture. They'll have to be a bit wider to accommodate the X carriage, higher so the Z axis does not scrape it's butt on the ground, and braced for extra stability. None of it needs support for printing.

That's enough for now. I'll get back to it. More news & photos as I sort releasable stuff out. Just remember that I'm going to be releasing this as soon as it is vaguely usable, and as yet it isn't!

Around the RepRap Community

Sunday, 12th June 2011 by Neil Underwood

So much has happened in the RepRap community since my last update. Hackerspaces and building RepRap can really suck the time out of you. Because there is so many awesomethings going on in the community that are not documented in the RepRap wiki, this post is going to include lots of non wiki related material.

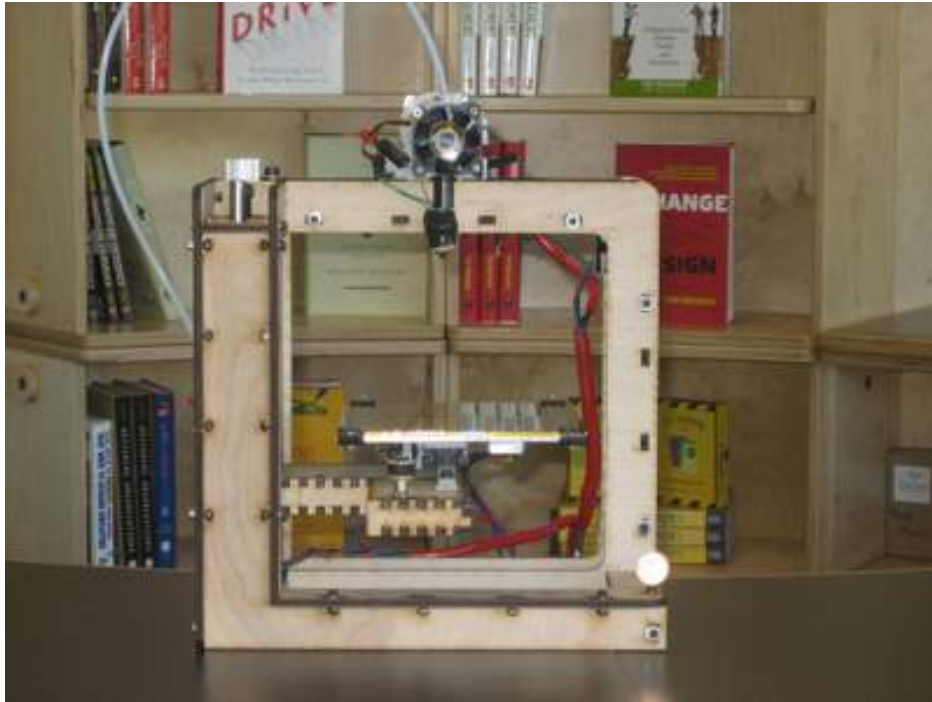

Makergear Mosaic

Anyone who knows me knows I have a soft spot for RP parts 3d printers, but the Mosaic is something special. This is the 1st RepStrap kit available with linear motion rails on the X and Y axis and a multistart tefloncoated ACME leadscrew with 2 linear rods on the Z. It only takes a cursory glance to tell the design is inspired by the Up! by PP3DP but with all the things to not like about an Up! fixed:

UP! closed source / Mosaic will be open source after 1st shipment

Up! \$2900 plus \$150+ Shipping / Mosaic \$999 + less than \$50 shipping

Up! Proprietary Electronics / Mosaic Ramps Electronics (No electrical part costs more than \$30 to replace)

As you can tell, I am a bit stoked on the Mosaic, can't wait to see more pictures of the stuff that comes off the machine.

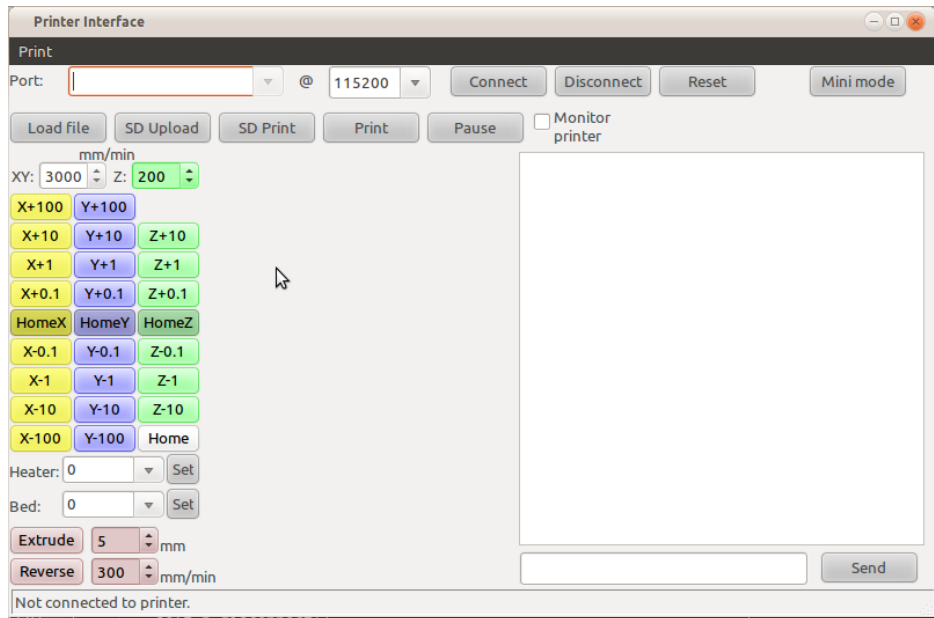

Pronterface

Kliment, another one of our devs who seems to not sleep has released a really nice new printer interface for RepRap. This interface is designed from the start to work with SD card on both Ramps and Sanguinololu. The great thing is it defaults to 115200 connection speed so your not having to change the connection speed every time you turn on your machine.

Sprinter Firmware

Sprinter is a new generation of firmware for reppap. This is the 1st firmware that has native support for SD card, andextremeacceleration. This firmware can run a printer at up to 300mm/s, which really changes the quality of a print. Sprinter has been tested and works on Gen6, Ramps, and Sanguinololu.

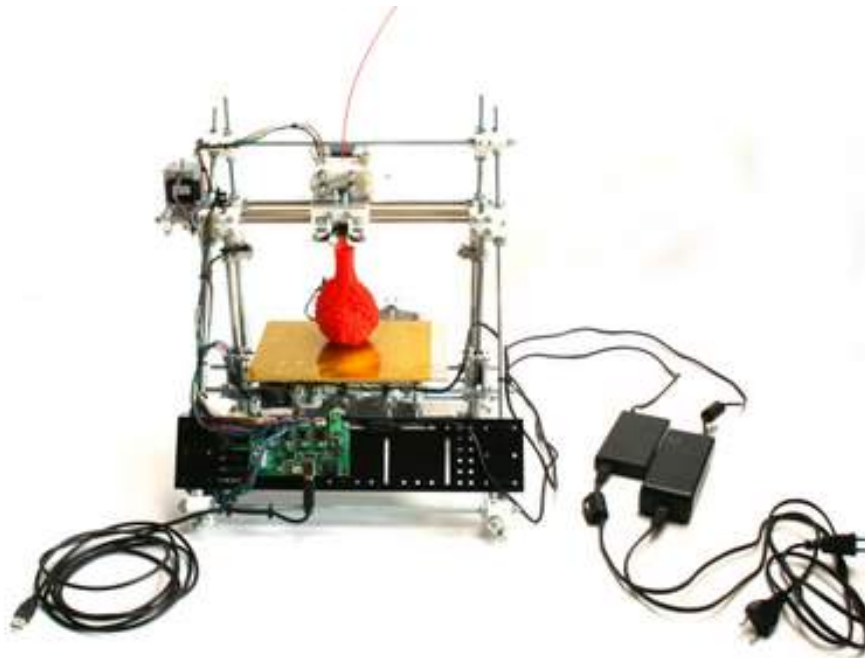

Mendel parts Orca

Mendel Parts is transitioning over to the Orca from their Sells Mendel design. Orca is Mendel part's 1st inhouse designed RepRap, and maintains the 200x200 traditional build area for a RepRap. At \$816 it's a really good deal on a kit.

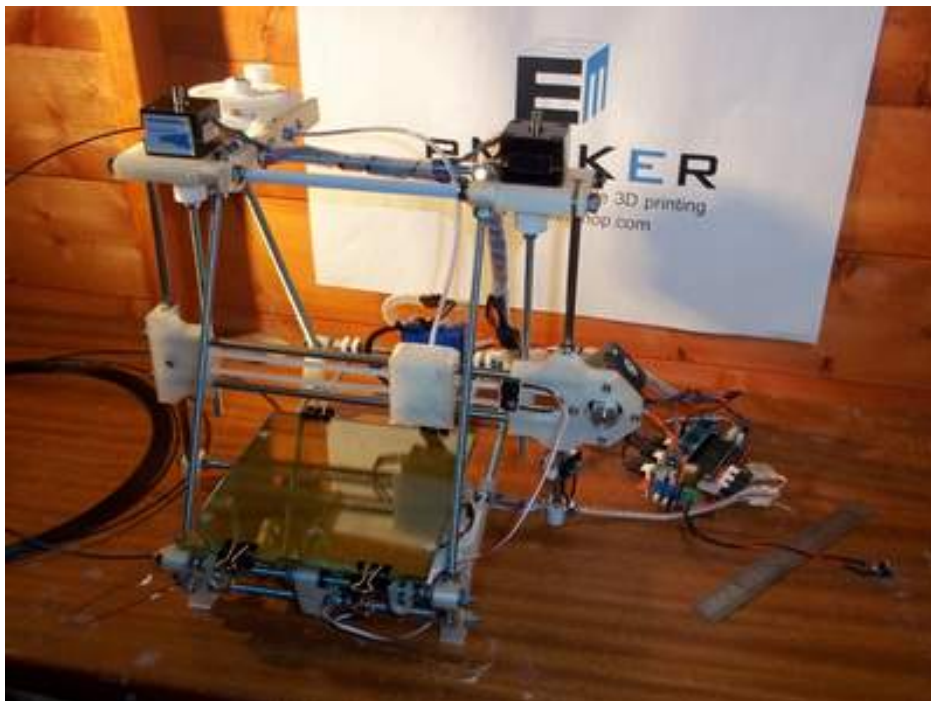

EMaker Huxley

I love cheap, I love RP parts, and I am fascinated by the bowden extruder with 1.75 filament. So here is something special. This is a \$475 full kit for a RepRap with 140x140x110mm build area,

SD card support, and everything included for less than \$500

Less than \$500 for a full RepRap, That's right folks it took less than 1 year (Oct 2010 to now) for the cheapest RepRap kit to go from \$1000 to sub \$500. No one knows how long term this price is considering it's from a reputable dealer though a kickstarter style offering, but he got the money for the project and he is saying around August is the delivery time.

Huza for a \$500 RepRap kit!

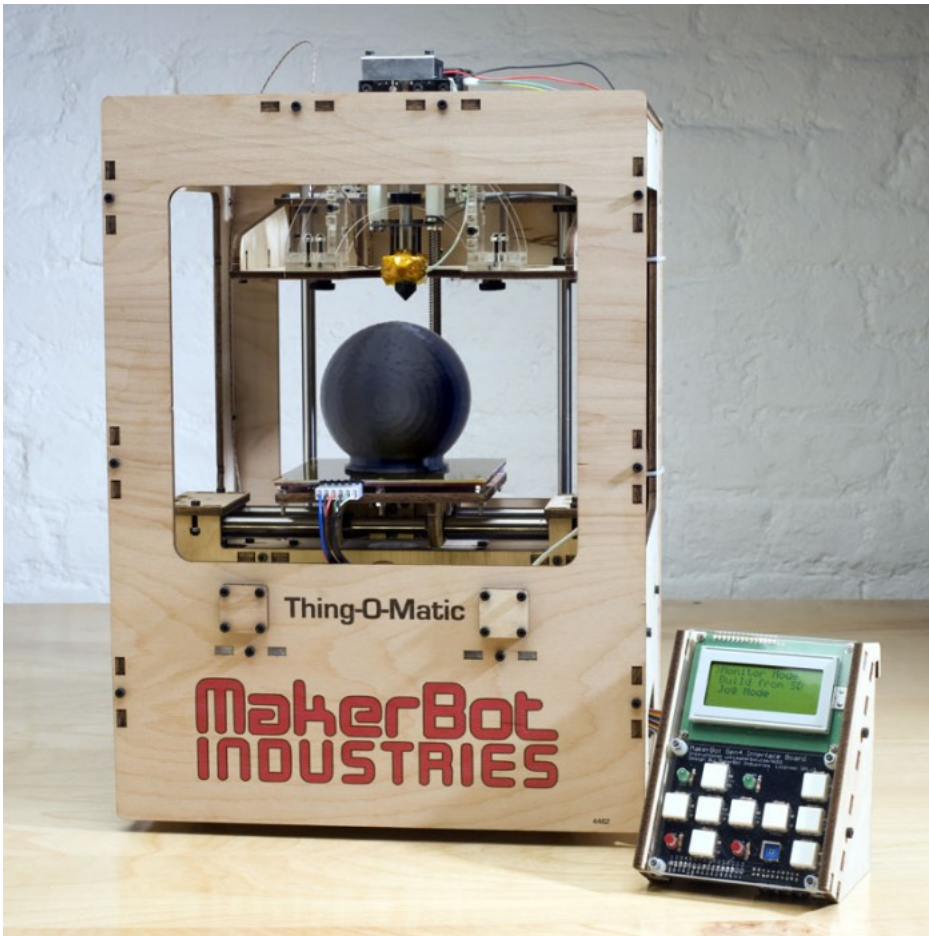

Assembled MakerBot

For as long as I have been around this community I have seen people wanting a preassembled RepRap/RepStrap. Well at long last it is here. Makerbot is now offering to preassemble their \$1300 Makerbot kit for an additional \$1200 fee.

No news yet on how they are going to handle people who don't know how to fix their machines, but this should make for fun times in the Makerbot and RepRap IRC when people don't know how to take apart their hot end to clean out a jam.

I know I missed a lot of stuff in the post, the RepRap devs have been busy these past few months,

I will attempt to get back to posting on a regular schedule again.. Thank you all for your work and have fun!

A "string wars" approach to the y-axis

Tuesday, 14th June 2011 by Forrest Higgs

Darwin and it's direct derivatives uses two belt loops driven by a shaft connected to a NEMA 23 stepper.

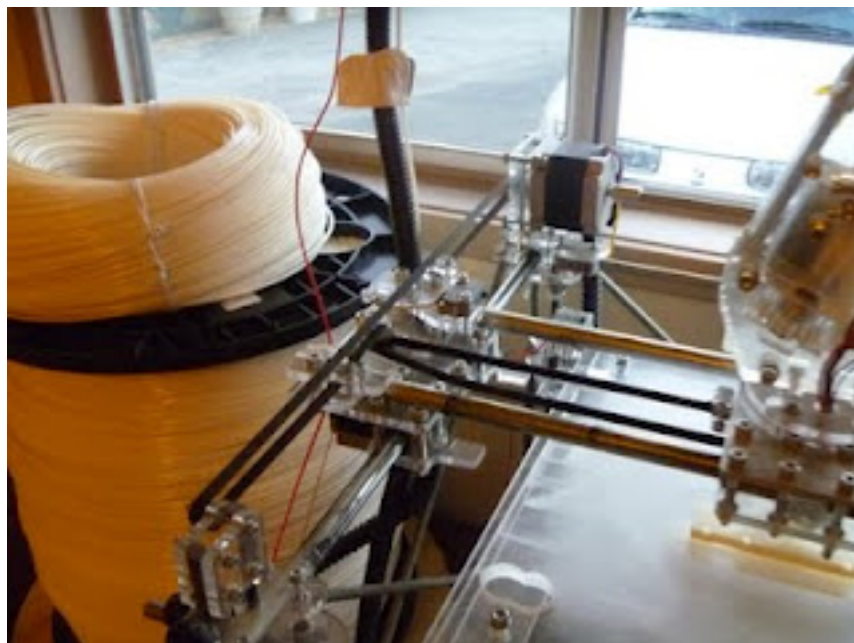

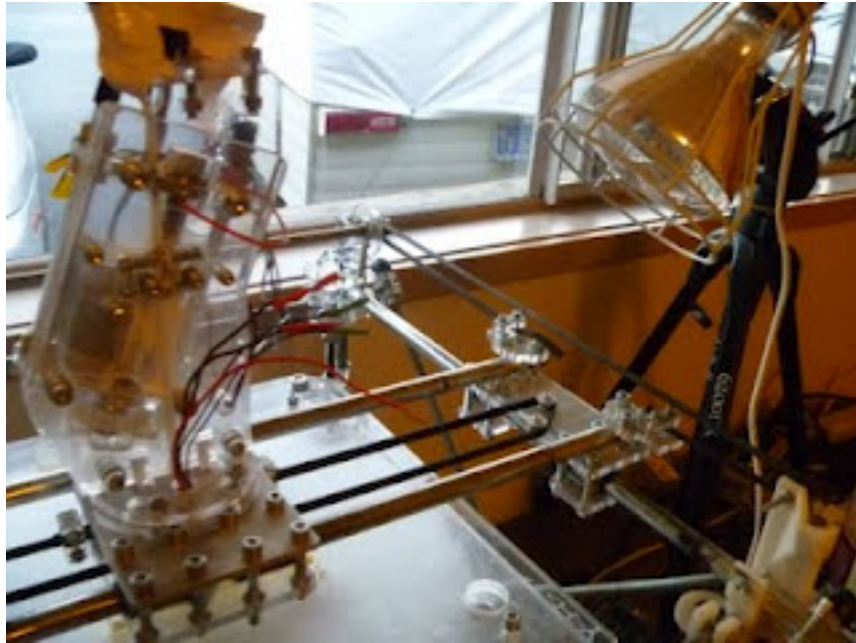

In Sampo, that dual loop arrangement has been replaced with a single large loop



The belt guides are equipped with standard 608 skateboard bearings with printed fenders.

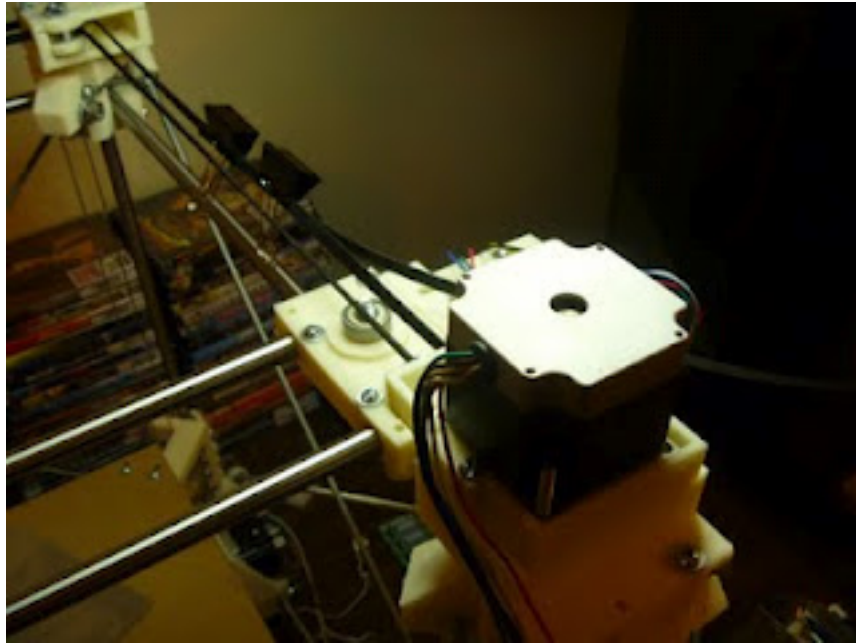

Topologically, the y-axis is simply an attenuated version of the x-axis.



Reprap at the NextGen Science Fair 2011 in San Francisco

Tuesday, 21st June 2011 by Forrest Higgs

After many misgivings about the direction of the event {it was the Cable TV channel TasteTV's first such event}, the NextGen Science Fair 2011 came off very well. The number of exhibitors was quite small, and the entry fee was substantial at \$25. I expected a few hundred people at most. In fact, I think we got many times that. We had a thick crowd around the Reprap table virtually all day long.

I brought my Rapman and my nearly complete Sampo and Brook Drumm, who set up the RepRap/MakerBot Builders in Northern California, showed up with his Makerbot Cupcake and his nearly complete Mendel. He's used his cupcake to make Mendel parts sets for everybody in his group since January of this year. Brook has become an accomplished Reprapper in a very short amount of time..

Here you can see Brook Drumm {left} of the RepRap/MakerBot Builders in Northern California talking about his Pra Mendel.

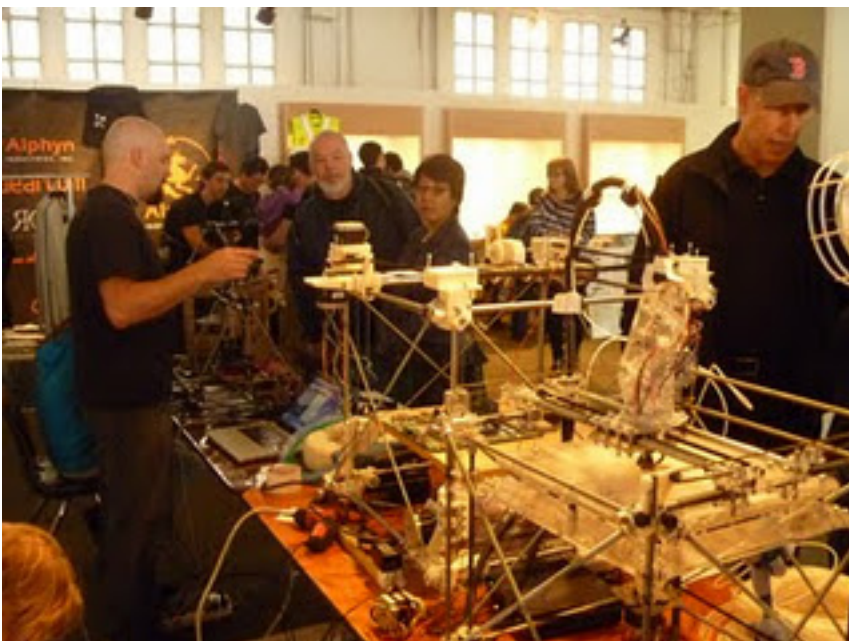

You can see from left to right, a Makerbot Cupcake {to the left of Brook}, a Pra Mendel just below his hands, the nascent Sampo printer and a Rapman 3.0 at the far right.

Brook and his daughter/assistant Sydney with their Makerbot Cupcake in printing Mendel parts.



Brook Drumm's Pra Mendel made from parts printed by a his Makerbot Cupcake.

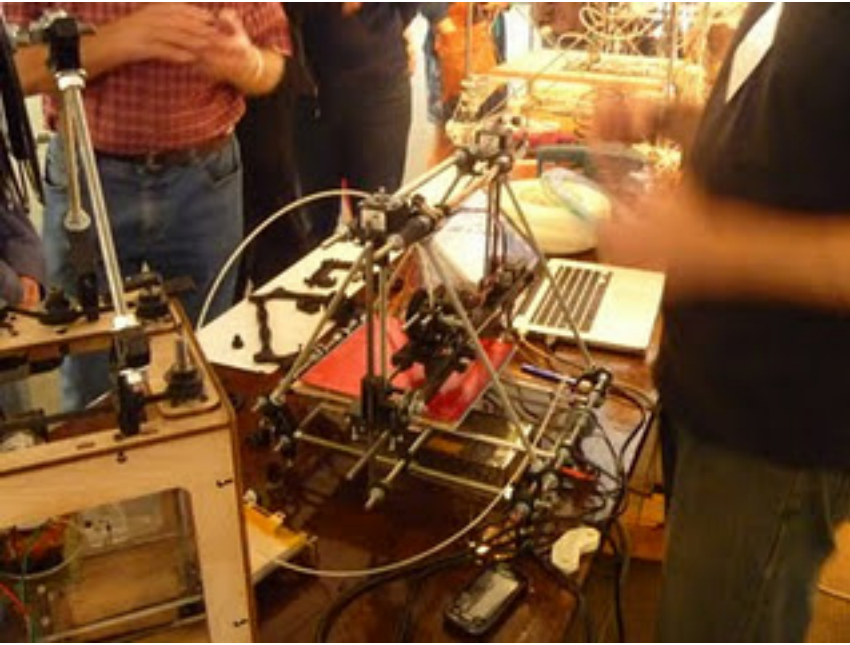

A Darwin-derivative Rapman 3.0 monitored by Adriaan Higgs printing a y-axis drive belt gripper for the next generation Darwin-derivative Sampo printer just to the right.



Adriaan demonstrating the technology differences between the Rapman and the Sampo Darwin-derivative printers.



Showing the familiar Reprap banner at NextGen Science Fair 2011.



A new approach to printing metals

Friday, 24th June 2011 by Rhys Jones

There have been numerous attempts to print conductors. Fab@home, Ed Sells and myself have all tried it previously with very limited success. Whilst I've been able to print a basic circuit from solder, we were unable to achieve the resolution to produce anything but the most simplistic circuit board. ForrestHiggs and others have tried to identify a useful non-metallic conductive material but conductivity has always been fairly poor. Months ago I blogged about using Nickel Carbonyl powder for exactly this purpose. What I didn't blog about was an experiment I did mixing the nickel with a low melting point alloy. When molten resulting semi-solid material had significant viscosity and effects of surface tension seemed minimal. Just by stirring the mixture with spoon it was obvious to Adrian and myself that there was so much control that this like a suitable material to print conductors with.

I did actually make filament using this composite material using the old technique of casting into silicone tubing. I was betting on the mixture not separating due to the ridiculously small particle size of the nickel carbonyl (about 2 microns). Alas I was wrong, the mixture separated and the powder blocked the nozzle but the fundamental concept of using a semisolid to gain more control over the extrudate seemed like a good one. Logically this is perfectly sound, it could potentially allow us to deposit material on top of this semi-solid material without it going completely fluid and losing its shape.

Fortunately non-eutectic alloys also offer this ability to have solid elements suspended within a molten liquid. Further they have the benefit that as the temperature increases the entire alloy completely melts thus we can further control the viscosity with temperature as well as the alloy composition.

After some thought I proposed that our ideal material would have a similar melting point to PLA /ABS such that when deposited on top a minimal amount of damage. I thought at the time (and this later proved to be wrong) that the alloy should be as viscous as I could achieve at the initial point the alloy melts; Then the material would have a gradual transition as the temperature is increased. I did have a hunt around but I was unable to find a material that I thought sufficiently these attributes. But we are now a community of at least 4000 machines, so I don't think its too

impractical for us to do what any of the big commercial additive manufacturing companies would do and have our own alloy.

I decided to go for an alloy of tin, indium and bismuth for a few reasons. Firstly tin is comparatively cheap, so I was hoping to get the properties we need with very little amounts of indium and bismuth. Secondly indium tends to lower the surface tension of molten alloys, thirdly and most importantly there is a lot of data on the melting point of alloys containing these elements so it'd be fairly easy to tune it to be comparable that of PLA/ABS. This would let us to print onto the plastic whilst causing minimal damage.

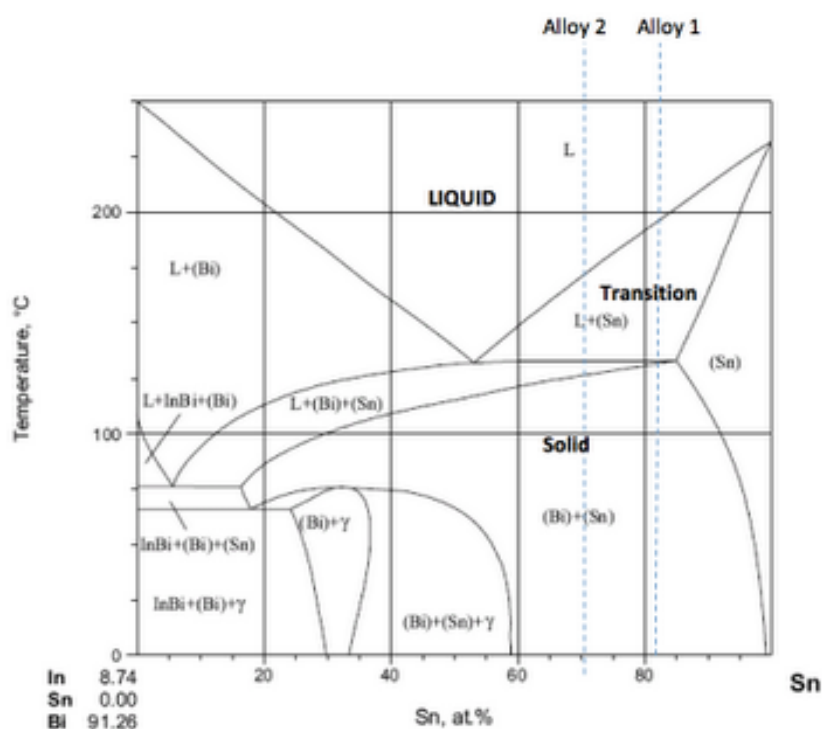

Above is the phase diagram for the system. My first alloy was 69.9% tin 29.2% bismuth and 0.9% indium (wt. %). Per kilogram the cost of the material was about £90 and I converted it to filament using the same casting trick. However this was a one off order so I anticipate it being substantially cheaper in quantity. The phase diagram predicted that this alloy should be about 80% solid when it begins to melt at about 130 deg C, and be fully molten by just under 200 deg.



The above was printed directly onto glass. I decided at the start of all this that if we are to produce useful circuits, we need to have sufficient control to build the track free form directly on top of PLA. Previously we needed channels to get any sort of the consistent track so this was already a big step forward. The rounding at the corner is due to the layer height being slightly off, which seems particularly critical when compared to plastics.

After the initial success, this is where the onslaught of problems began. Something I did not anticipate was that the alloy began to dissolve the brass nozzle due to solubility effects after very little use. In practice this meant that my extrusion parameters were constantly varying until the nozzle completely disappeared (this happened within about 15 meters of 3mm filament). I also attempted an aluminium nozzle with the same result.



At this point we were a bit stumped. Adrian suggested trying to make an all PTFE extruder (at least as far as the alloy was concerned). After several iterations the best solution was machining a PTFE liner with a built in nozzle. This was then surrounded by the usual brass heater etc like our hybrid extruders. Whilst I accepted this was not a long term solution, I thought that if we could get it to work in steady state conditions we could learn more about the process.

As it turns out with extended use the alloy was so viscous the alloy physically ripped the PTFE liner that serves perfectly well in our plastic extruders. Further it was apparent a black oxide was forming at the entrance to the nozzle. After a few hours use this ended up in a complete extruder failure.



After this failure it was fairly apparent that my initial alloy was far too aggressive. I therefore scaled it back to something that would operate at lower temperature (reducing oxidation times) whilst also having a lower viscosity to put less stress on the PTFE liner.

I guessed that a 50% liquid/solid ratio when the alloy begins to melt would be sufficient, and this turned out to be a composition of 57.5% Sn, 41.3% Bi, 1.2% In, again beginning to melt at 130deg but finishing by about 170. This proved much more reliable and with much less oxidation. It allowed me to produce the results below printed directly onto glass (it was flat before I peeled it off). The second image is particularly interesting as its three layers of track on top of one another, which would be required for tracks connected in parallel. I've also gotten similar results printing directly onto a PLA substrate, in this case it stuck fairly well but could be removed with a bit of force.

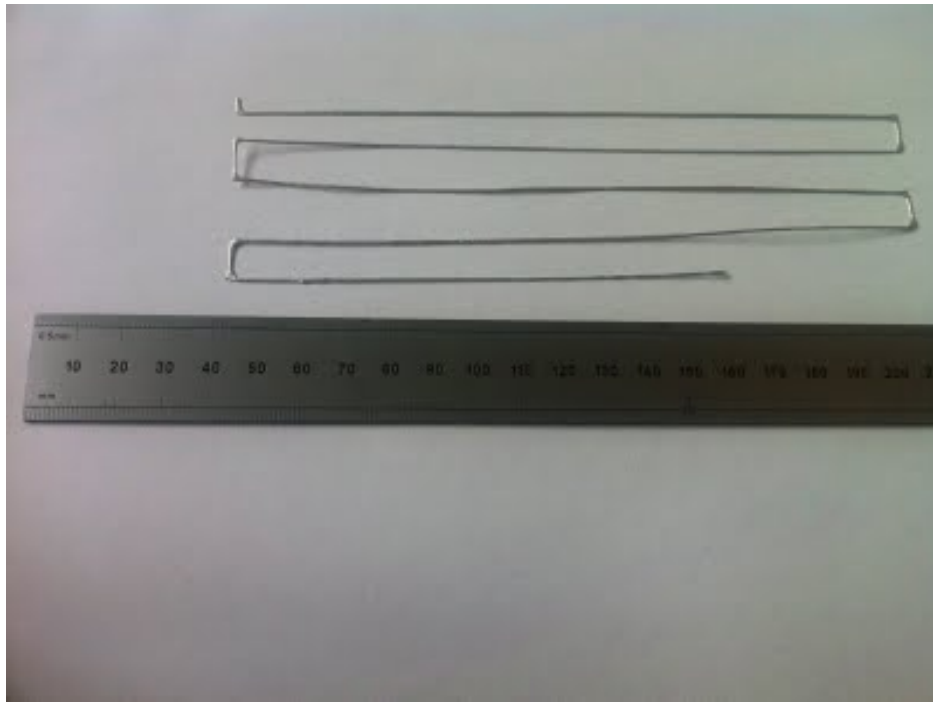

Whilst I've achieved fairly decent results with this setup, the transient performance was unsurprisingly poor given the insulating nature of the PTFE and the large melt zone I needed to get it to work. I therefore went back to solving the underlying problem of the alloy dissolving the nozzle. I've had ago at anodising an aluminium nozzle which is fairly easy, it just requires about 200Vdc and the appropriate electrolyte. At the moment the nozzle design is still varying a bit, but I've taken pictures under a microscope both after anodising (first pic) and after extruding about 10m of 2mm filament. As far as I can tell there hasn't been any substantial wear.



After about 10 different extruder iterations (most I haven't mentioned here) It appears that the dissolving issue has therefore been solved. I haven't quite finished calibrating this extruder, but the latest results are below. Naturally its our logo, the track size is about 0.7mm in diameter. Given this was fairly successful I also tried doing it with infill, unfortunately it overheated as the filament didn't have chance to cool but I still think its quite successful. I need to try repeating this with cooling from a fan. I would have continued this build further but I can only make lengths of filament about 30cm long and changing them mid print is quite tricky,



-

Picking up speed

Tuesday, 5th July 2011 by Forrest Higgs

The MIPS core that PIC32 uses is a very high performance CPU that was used in high end Windows workstations in the early to mid-1990s. It doesn't behave much like the 8 and 16 bit PIC chips, so it's taken me a while to get down the learning curve. The button function in the Mikroelektronika compiler library works, but requires about 10 msec to filter out the bounce when a limits switch is encountered.

Processing a button function for each step when I was running at half step slowed the y-axis down to 12-15 mm/sec. To get around that problem in firmware I wrote a smart limits switch routine that runs slow until it finds the first limits switch and then kicks the stepper motor up to full speed until it nears the other limits switch.

Using this approach lets me increase the maximum transition speed for the y-axis from 15 mm/sec to about 65 mm/sec for my firmware testing as you can see in the video clip.

It's worth noting that the Allegro driver chip has a maximum rating of 0.75 amps and the NEMA 23 is a six wire model drawing 0.5 amps per phase. I've wired it in series which brings that amperage down considerably. In spite of this I'm getting 65 mm/sec and both the stepper and the NEMA 23 are running quite cool. The driver chip requires no heat sink or fan.

Surface-Oriented CAD, Math, & Telescopes

Saturday, 16th July 2011 by Christopher Olah

One of the many projects eating away at my time has been an alternative approach to programatic CAD that I'm calling "surface-oriented CAD" (as apposed to CSG based CAD, like openscad). Loosely based of the code I had for generating models of mathematical objects, the sorts of things that surfcad makes easy to make are very different from in something like openscad. For example, this is easy:

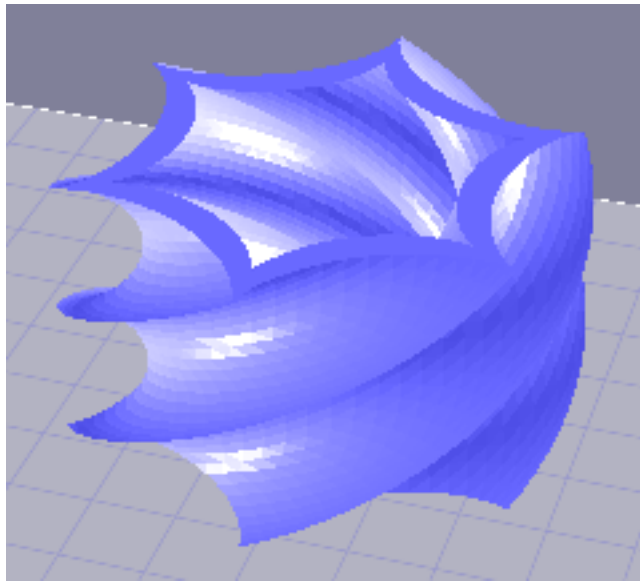

You can read more at my [original post](#). Some people may be most interested in the final section, in which I discuss my attempts to 3D print a telescope (designed with surfcad, of course) and the problems I'm running into.

Around the RepRap Community 07/15/2011

Saturday, 16th July 2011 by Neil Underwood

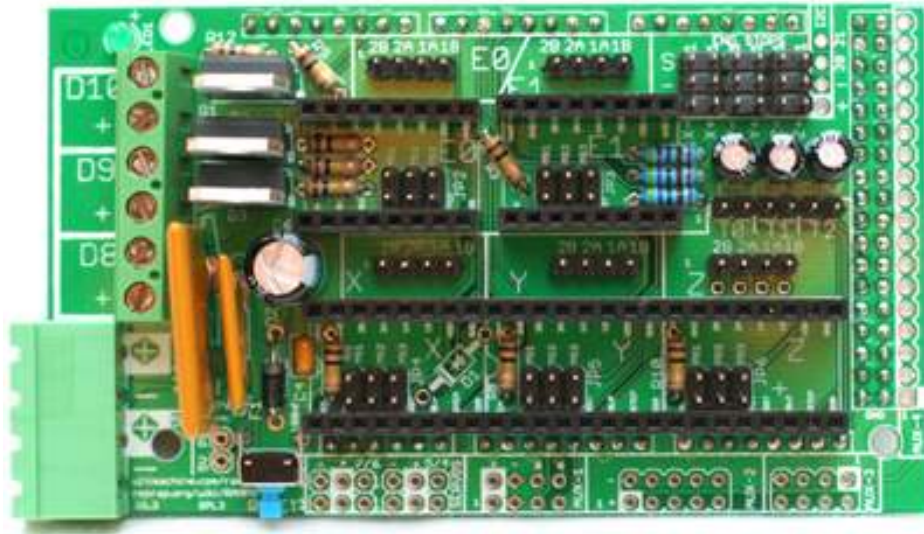

Ramps 1.3

E0 & E1? Wait does that mean that RepRap now has Hardware side support for multiple extruders? Ohh no, what evil things could this community do with 2 independently controlled extruders? I am sure I will be posting about that in the next month. :) Ramps 1.3 by JohnnyR (His webstore is at Ultimachine.com) has many upgrades over the 1.2 version of Ramps.

-Independent power inputs for the cartesian bot (5A), and the heated build plate (11A). This allows you to plug both sides of the heated build plate into the electronics instead of having 1 line to the D8 and the other to the PS.

-Dual Extruder support, need I say more?

-Unfortunately this is the 1st Ramps that is not made to be etched, but with that loss you get a much easier to work with board. The spacing on plugging in stepper motors on Ramps 1.2 was VERY tight, on 1.3 it's not so tight, not dead easy like a Sanguinololu, but much better, especially considering there is a lot more on the board.

-Marked Servo ports. Ramps does not kill your access all those extra ports on an Arduino, but Ramps 1.3 is the 1st to mark those on the shield to remind you that Ramps really needs 5-6

servos and 2-3 accessories added. Maybe a sd card reader?



Greg's Hinged Accessible Wades

The Wades Extruder has been the gold standard of strength and efficiency in the RepRap community for over a year now. I would say 80%+ of all the RepRap in the world run it, mostly because it works GREAT, doesn't slip unless you did a poor job on the hobbed bolt, and is quick to print.

Greg Frost has taken this design and brought it into 2011 with a complete ground up redesign. It takes a lot of tricks that we have figured out over the last year and applies it to the Wades.

- You can very securely hold a stepper motor by 3 screws instead of 4, less printed mass, easier to print.

- 1 spring on a lever is plenty to tension the extruder, less materials needed

- If your bolt is hobbed correctly there is no need to support the top of the plastic being fed, so it

gives you easy access to the pinch point

-It just looks cool



Support Material Manual

RepRap wiki dev [Madscifi](#) has done an amazing guide on how to use clay as a support material. The write is up top notch, lots of photos and step by step instructions. I love the original use of skeinforge's new perimeter function!



Image not found.



SD Card Reader for RAMPS and Sanguinololu

Kliment, of [Pronterface](#), [Sprinter](#), & [Prusa Mendelfame](#), has done something really awesome. He has designed and is selling a fully functioning SD card reader for the 2 most popular electronics in RepRap, RAMPS, and Sanguinololu. Many people in the RepRap IRC are using it and I have not heard a single complaint yet.

Printing from SD gives you

-Ability to print independent of your computer (You use a computer that has never been used for 3d printing before, download pronterface and kick start your printer, this can be a life saver)

-Much less pause do to communication, this is not nearly the issue it once was, but people have found that their build quality is even better using SD than with Sprinter alone.

If you want one just message Kliment in the [RepRap IRC](#), or order it though [Ultimachine](#).



StepStick, In The Wild!

Anyone who has been in the community for a while remembers the great stepper driver drought of early 2011. I am not kidding, RepRap production all but shut down for a few months because demand for the Pololu 4988-4983 completely outstripped Pololu's ability to produce them. In response to this [Joem](#), the guy that designed the [Sanguinololu](#) also made an open source alternative to the 4988. I have mentioned them before, but the reason I bring it up again is they are now available on ebay for \$14, \$1 more than the Pololu with free shipping (from China). Considering their shipping is free and Pololu is \$5 minimum, that would mean that it's actually \$1 cheaper to get the stepper off ebay than Pololu for a simple 4 axis RepRap. Win for open source!

Mendel's Birthday

Wednesday, 20th July 2011 by Vik Olliver



This is Gregor Mendel's 185th birthday:

http://en.wikipedia.org/wiki/Gregor_Mendel

Around the RepRap Community 08/06/2011

Sunday, 7th August 2011 by Neil Underwood



RepRap Cousins in Zero G!

Made in Space, a space startup founded to leverage 3d printing as a manufacturing tool in space, has operated 2 RepRap Cousin Projects in Zero G. They took what looks like a Makerbot Cupcake with what looks to be a stock DC gearmotor extruder in this image, a Makerbot Thing o Matic, and a Bits from Bytes 3000 on a ride doing Parabolic dives in a Zero G airplane. Can't wait to see the results, but I wish they had added a RepRap kit like Makergear Prusa, Emaker Huxley, or MendelParts Orca instead of 2 Makerbots and a closed source 3D Systems printer, but who cares, FDM in Zero G is awesome.

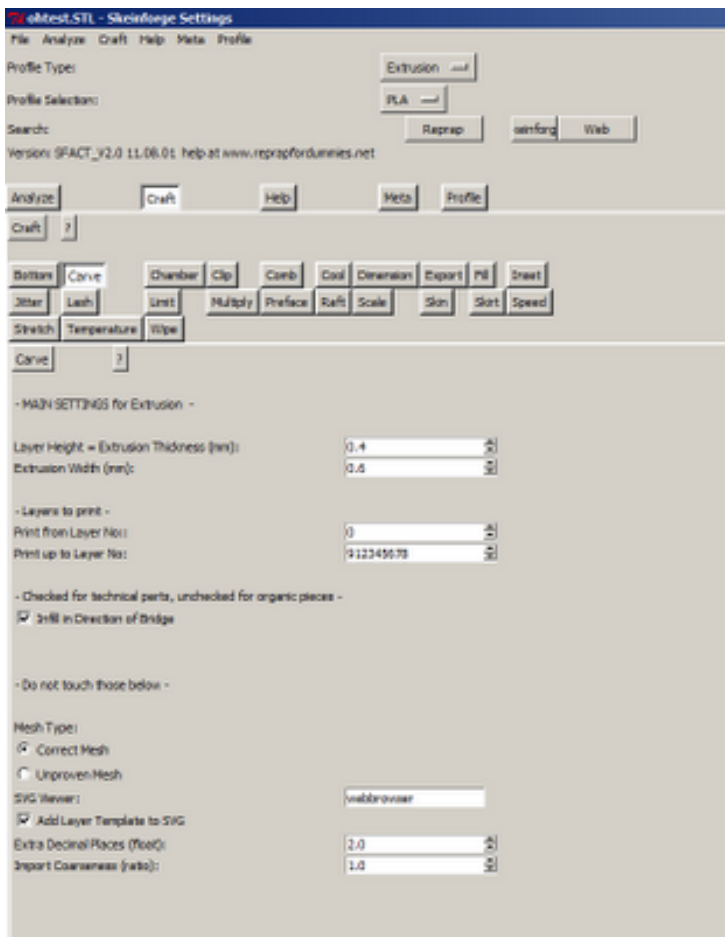

Sfact by Action68

Sfact might look like Skein forge, but it's a long way from it. What Action68 has done is cut down skein forge to just the pluggins that are still in use, and normalized all the defaults so that 90%+ of people will find that once you have set 5-6 parameters within skein forge you should be getting good prints. This is huge for Reprap because one of the biggest challenges is getting over the monstrous Skein forge learning curve. I really hope Enrique rolls some of these changes back into the master of skein forge. Instructions can be found at the [RepRap wiki](#), and tech support can be found in the [RepRap IRC](#).

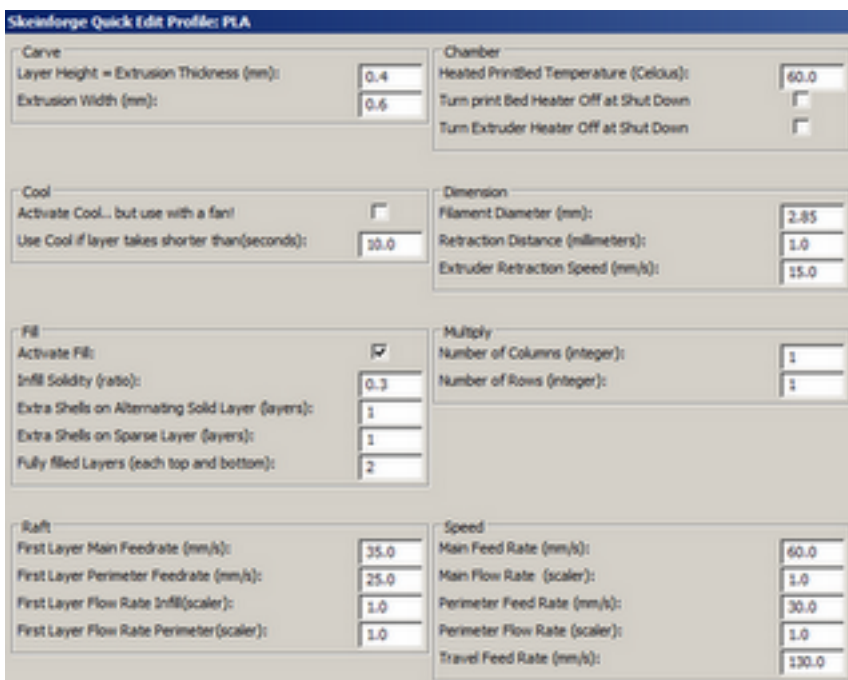
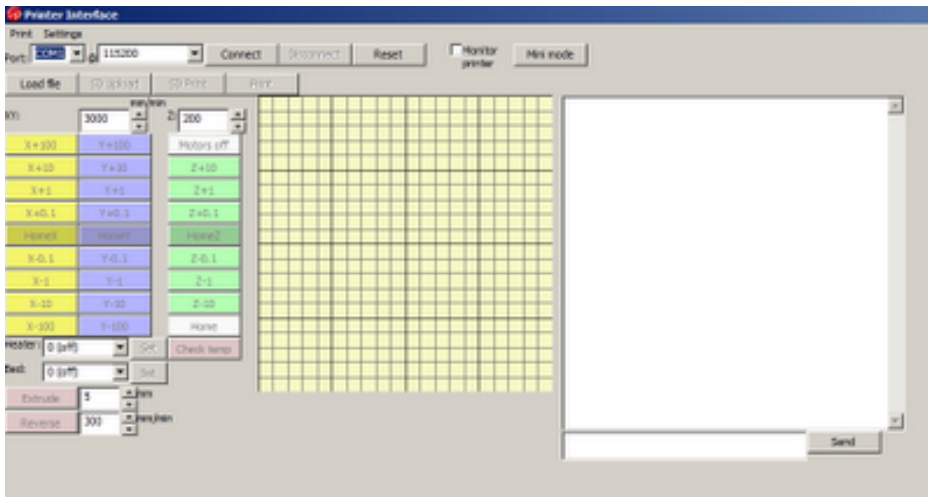

Pronterface, UPGRADE!

Pronterface, Kliment's Host program for RepRap, is evolving like no program I have ever seen. The comment log will show you why you really need to download the program at least once a

week. The Additions since the last post are just entirely too long to add in this post (go check out the commit log), but just a brief overview

-Executable versions of both Pronterface and Sfact can now be found [here](#). No install needed and Sfact is preintegrated with Pronterface

-Garyhogdson has added a truly amazing quick setup menu for Sfact integrated into Pronterface, you can change all the most tweaked settings from 1 screen... Amazing

-Integrated Gcode editing

-SD card support

-Custom Gcode buttons addable in GUI

-LOTS more

Finally I can stop missing ReplicatorG, Pronterface to me is now MUCH easier than RepG because of the Gcode simulation view and Gary's quick Skeinforge settings.

[Hostless \(computerless\) RepRap printing with RAMPS, SDRAMPS, SJFW, an LCD and keypad by ScribbleJ](#)

ScribbleJ, a long time designer on [Thingiverse](#) has developed an awesome piece of firmware that allows a basic keypad and LCD to be attached to a [RAMPS electronics](#) with [SDRAMPS](#). This gives you the ability to warm up, center, and execute a print all without ever having to turn on your laptop. This is hugely important for the long term development of RepRap, and part of the [Gada Prize requirements](#), so when you win your \$20,000 be sure to send ScribbleJ a case of beer. Instructions can be found at the [RepRap wiki](#), and tech support can be found in the [RepRap IRC](#).



Hall-Effect Sensor by Ruben-Ikmaak

For some people a limit switch that is only accurate to .1mm is just not going to be nearly accurate or cool enough. For those people RepRap has the Hall-Effect Sensor.

A Hall sensor is much more accurate than a mechanical, has no physical contact, and can act as a linear encoder within its sensing range.

Ruben-Ikmaak and Kliment are selling it in the RepRap IRC

Still Extruding: Installing Pronterface and SFact in Windows

Saturday, 20th August 2011 by Neil Underwood

With all the repeat tech support issues we run into in the #reprap IRC I have decided to start a biweekly webcast covering the most common questions asked in there. I should be publishing twice a week Mondays and Thursdays. If you have any requests for a video please just comment on the video, if you have further questions please post it in the #reprap IRC that way you get instant feedback.

Does the community have an issue if I post these videos here on RepRap blog or should I move it to my Hackerspace's blog ? I would rather post it here because the issues covered will always be 100% RepRap related.

Monday will be the difference between a \$350 RepRap (about as cheap as you can put one together), and a \$850ish RepRap, which would be with all the latest bells and whistles.

Still Extruding: RepRap Price Points

Wednesday, 24th August 2011 by Neil Underwood

In this video I covered what a very basic RepRap would look like (The Pink one), a "normal" RepRap would look like (Black one), and what a full out obsessive build would look like (The White MakerGear Prusa).

Thanks to the constant work of developers like yourself throughout the community, the base price point, and what it takes to make a truly beautiful machine continues to drop. But just because the lowest bar has dropped does not mean that all RepRap are created equal.

\$350ish Very Basic Prusa Mendel

A very basic machine means you will be getting the plastic parts from someone who already has a machine. If you're getting it free that very likely means you know this person, or are willing to trade for it with a local person who has a 3d printer or a Hackerspace. Also you're going to use lots of used parts. You can get used linear rod and steppers off the internet or at your local electronics recycler (think Goodwill in the US) or Ebay. The electronics I suggest Sanguinololu and Stepstick drivers off Ebay. No Heated Build Plate. Raw threaded Rod, hand polished smooth bar from the hardware store, a used ATX from your old computer (you only need 60W). As you can see at this point you are talking about a LOT of foot work, but it's been done.

This machine can print PLA 80% as well as the next step up, but because you don't have a heated build plate very large PLA prints, and even medium sized ABS prints are going to be very challenging. Your likely going to have a harder time trouble shooting because almost all your parts second hand or hand made. But a changing 3d printer is better than no 3d printer at all!

\$550ish realistically Cheap Prusa Mendel

\$550 is about average for a self sourced Prusa at this point. This has you buying your motors new from one of the vendors suggested in the wiki or IRC, your hot end from someone who has a good reputation, a Heated Build plate (If you don't have Milled Aluminum & Power resistors sitting around, get a PCB heater), and all Zinc/Black oxide Hardware. and a new power supply (switching or ATX)

This machine is basically the one that most RepRap classes build and the most common RepRap in the world. It can print ABS and PLA across it's full build area, and is a solid machine.

\$850ish Full out RepRap

At \$850 this is when you have decided to make a VERY nice machine. There are really 2 options here, self source or Kit.

The two \$850ish kits that I can suggest are Mendel Parts.com and MakerGear.com. I have bought products several times from Camiel at Mendel Parts and he is a really good guy, and man does he know how to shoot a nice video of his RepRap farm. On the other side you have Makergear, who I have bought every hot end I own from, and is a personal friend of mine. I can only speak to the quality of MakerGear's kit, because it's the only RepRap kit I have ever put together, and it is wonderful.

The other way is to self source. At \$850 you can afford to get really nice motors like the ones sold by MenelParts and Ultimachine with the connectors already on, nice stainless hardware, plastic parts for your favorite flavor of Prusa, like a Felt, Im8uu, brass, or self centering brass, a geared stepper extruder, heated build plate.

This machine will print equivalently to the \$550ish RepRap, but sourcing is easier, and if you get the kit from a vender, they do owe you some tech support.

The best way to get guidance on what kits to buy, or where to get supplies is in the [RepRap IRC](#)

Michael S. Hart, e-book inventor and Project Gutenberg founder, dies at 64

Thursday, 8th September 2011 by Forrest Higgs

Michael was also a long-term core team member and supporter at Reprap.



He will be missed.

Being in a 3D world, with a 3D printer? what do I need? A 3D scanner!

Thursday, 8th September 2011 by Buzz

It turns out that I've well and truly been beaten to the punch when it comes to rewrapping 3D scanners and such, so this post isn't about hardware, but more the software / workflow I've been playing with. I'm standing on the shoulders of giants here, none of the tools are mine, I'm just trying to build a workflow for a 3D "photocopier"! one_object->scan->[stuff]->print->two_objects = awesome!

In my case this is:

SpinScan - laser scanner hardware and point cloud generation

- by tbuser, awesome

<http://www.thingiverse.com/thing:9972>

On my mac, I installed the following to make this work (it's Processing based, so should work anywhere very similarly) :

Processing 1.5.1 <http://processing.org/download/>

OpenCV Framework <http://ubaa.net/shared/processing/opencv/download/opencv-framework.1.1.dmg>

and then downloaded these extra libraries:

OpenCV Processing library: <http://ubaa.net/shared/processing/opencv/>

ControlP5 library: <http://www.sojamo.de/libraries/controlP5/>

(unzip the libraries, and copy the zip contents as-is to /Applications/Processing.app/Contents/Resources/Java/modes/java/libraries/)

I then opened the spinscan.pde from GIT (github.com/tbuser/spinScan) with the Processing.app, and it loads, and runs (press play etc).

Once it's setup and working right , the SpinScan software generates a .ply file.

for more, read here:

http://en.wikipedia.org/wiki/PLY_%28file_format%29

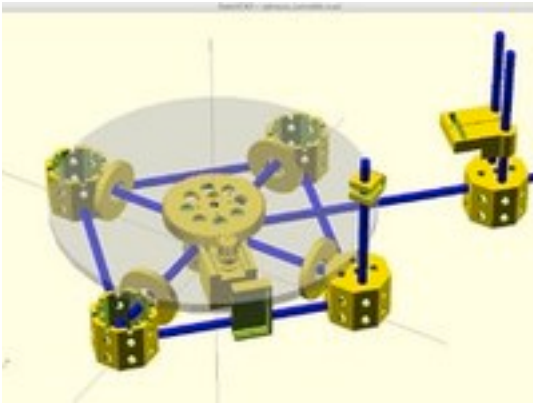

meshlab for point cloud -> stl / triangulation , (by many many people smarter than me) :
(use the latest meshlab) .

once you have a .ply file, convert it to .stl with meshlab using these hints...
or here's one possible method:

summary:

subsampling , normal reconstruction, surface reconstruction / triangulation, cleaning up and assessing.

1. open meshlab (starts with an empty project)
2. File -> import mesh -> [browse to and locate the .ply file you generated in spinscan or similar]
3. Open Layer view (7th icon from the left , looks like a pile of papers)
3. SUBSAMPLING: Filters > Sampling > Poisson-disk Sampling: Enter the Number of Samples as the resulting vertex number / number of points you want. Good to start with about the same number as your vertex to maintain resolution, or if you have a very large file, choose something like 10000 or so to reduce your point cloud to something easier to work with) - you MUST tick the "Base Mesh Subsampling" tickbox or you'll get an error here.
4. COMPUTE NORMALS: Filters > Normals/Curvatures and Orientation > compute Normals for Point Sets [set neighbours = 10 or 20]
5. TRIANGULATION : (try any of these, and see which works best for you) :
 - a. Filters > Point set -> Surface Reconstruction: Poisson, set octree to 11 (ish) [you should now see a new layer in the Layer Dialog to the right] but really strange border! (increase this to 12 or 13 if you loose too much resolution on your object at 11.)
 - b. Filters > Point set -> Marching cubes RIMLS. Set Grid resolution to 1000 for a detailed mesh, or approx 200 for less details.
 - c. Filters -> "Remeshing , Simplification and reconstruction" -> Alpha Complex / Shape (might work, not sure)

6. Fill holes by Filters -> "Remeshing , Simplification and reconstruction" -> Close Holes , picks out number automatically

7. SAVE MESH !

save often as program crashes a lot!

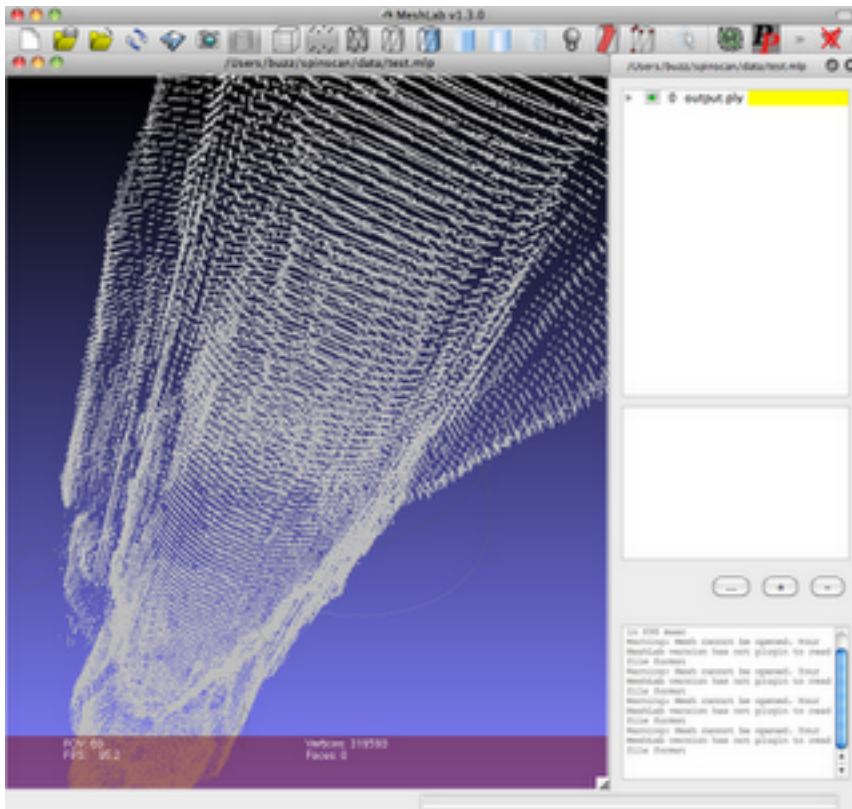

here's a way that someone else did it:

<http://www.instructables.com/id/Using-Meshlab-to-Clean-and-Assemble-Laser-Scan-Dat/>

A Tipping Point of Print Quality (Open Source for the win)

Friday, 9th September 2011 by Neil Underwood



On the left is the Venetian Lion by Tony Buser printed by Prusajr on a \$550 to assemble RepRap Prusa, on the right is the same model printed on a Stratasys uPrint+.

Its official, RepRap has now surpassed the commercial Fused deposition modeling 3d printers in machine affordability, price for filament, and NOW build quality.

To be specific the machine that Prusajr used to do this was a RepRap Prusa, with a Makergear Plastruder, Felt bearings on the Y axis (yes normal clothing felt), Brass on the X axis, and LM8UU on the Z axis for the hardware. On the electronics/firmware end he was using Sprinter Firmware, on Ramps Electronics, sliced by Skeinforge and hosted by Pronterface Host software, and printed onto a PCB build plate. So basically nothing more than a standard run of the mill RepRap.

Of course we have always had some people who had epic build quality for years now (See Nophead), the big change is that the barriers to entry have dropped significantly:



Thanks to the new Volumetric Skeinforge (Skeinforge 41), and the fork of Skeinforge called SFact by Action68 (Ahmet Cem TURAN) even makes the slicing of the models straight forward. As an example:

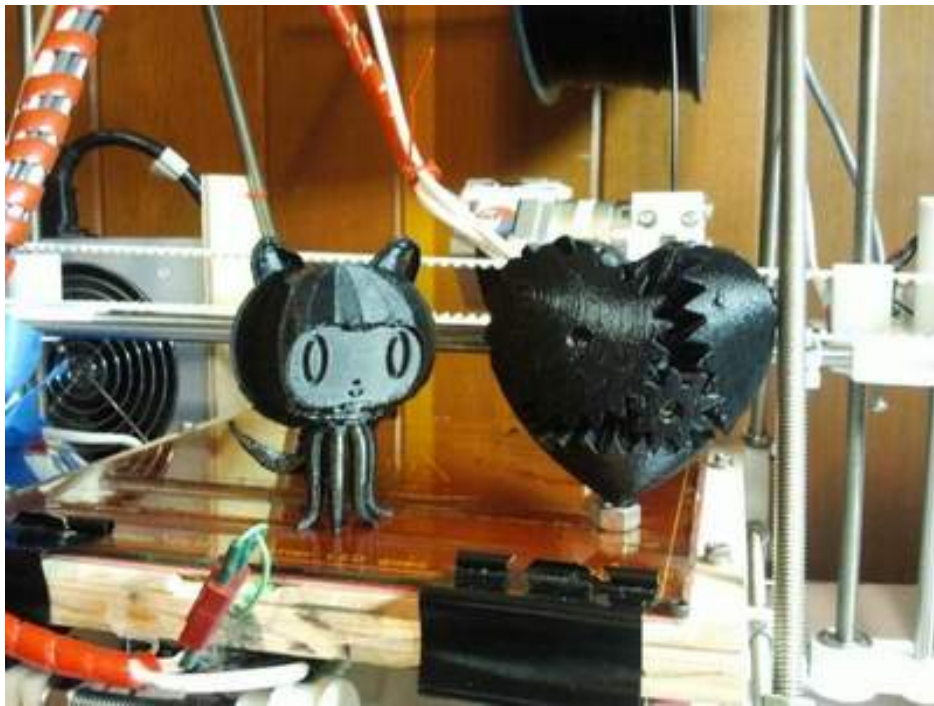

I did these on my Makergear Prusa after only changing **1 LINE** in the Sfact setup, and that was just to tell Sfact the diameter of the filament I was using, everything else was handled by the Skeinforge back end and Sfact front end in Sfact.

Again, as an Administrator with RepRap I want to thank all the developers out there around the world, for helping use reach this milestone. We will continue to get cheaper, easier, faster, higher in quality, and more common through your hard work, thanks for all you do.

Hear Adrian Bowyer on BBC Radio

Saturday, 1st October 2011 by Adrian Bowyer

Adrian is interviewed by Shaun Ley about RepRap on Sunday 2 October on the BBC Radio 4 news programme *The World This Weekend*. The interview will be transmitted sometime between 13:00 and 13:30 UK time. You can listen on air or on line. The programme link is here:

[The World This Weekend](#)

Still Extruding: Catching up

Wednesday, 5th October 2011 by Neil Underwood

Many apologies to the people that find the series helpful, I had a family emergency, and a a work change that threw my tutorial stuff out of wack. I have about 10-12 video to upload, so as not to overload folks I will be uploading them 2 at a time here. Please if you find issues in the video comment in the video, but if you have questions go to the [RepRap IRC](#).

While doing tech support I find a lot of peopel are intimidated by the idea of altering firmware. That's understandable, when I started I REFUSED to change it for fear of destroying something. The 3 big firmwares for RepRap right now [Sprinter](#), [Marlin](#), and [SJFW](#) all use basically the same configuration.h file based off Sprinter. I hope this makes firmware alteration a little less scary.

Powering a RepRap from an ATX is really not that hard, but for a lot of folks it can be quite confusing. I should have edited this video down, but I find that a lot of times it's the little things that seem to throw people off on this one. The Yellow wires are the 12+ line and for the most part the only one we use. If your going to power something like a HBP you need to power it off 2 legs at once, the easiest way to get 2 legs is to find the square 4 pin plug with 2 yellow and 2 Black, each of those yellow should be on separate legs and make it (hopefully) strong enough to survive a Heated Build Plate. Strip both yellow and black wires, twist them about themselves and attach them to the 11 amp connector on your electronics. Everything but the HBP can be ran off 1 leg, best way to find 1 leg is just grab the 4 pin Molex connector and connect to the 1 yellow (12 volt) and the 1 black (ground).

Again if there is an issue with the video, comment on the video so I know I need to reshoot it, but if it's a technical question, go to the [RepRap IRC](#) for our free 24/7 Tech Support/Bazaar/Robot Support Group.

3D Systems Print Quality Mixup

Thursday, 6th October 2011 by Neil Underwood

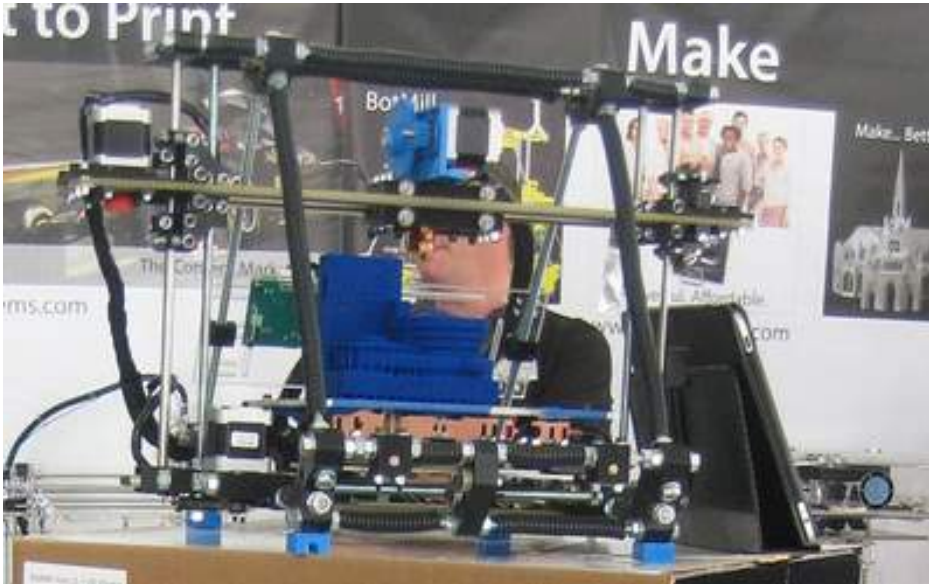

Above is an enlarged image from [3D Systems Botmill Branches Flickr account](#). Do you notice anything strange about the build quality of that part? It was NOT printed using the wades extruder above it. This was a fun catch by Prusajr while visiting the United States for Maker Faire and the Open Hardware Conference.



3D Systems makes some wonderful machines, the printed part on this RepRap did not come off a extruder based 3d printer.

I thought maybe someone not related to 3D Systems had just set it there, but when I went back and looked though their official website, there it was on their Flickr Page.

Note: I contacted Cathie Lewis, the VP of Marketing for 3DS and she said confirmed that part did come off one of their Personal 3d Printer and was an unintentional mix up by one of their employees that was corrected by the 2nd day of the Maker Faire. I only posted this so that any of the people at the Maker Faire who saw the part would not be confused. We are not quite there on the print quality, but we are getting closer every day. :)



RepRap Meeting in Bath

Friday, 14th October 2011 by Adrian Bowyer

If you're in the Bath/Bristol area of the UK at the start of November and would like to see RepRap and hear a talk on it, why not come along to this:

<http://digitalmanufacturinglab.com/index.php/get-involved/upcoming-events>

It's free :-)

Say goodbye to unsightly STL triangle misery!

Forever!

Wednesday, 19th October 2011 by Adrian Bowyer

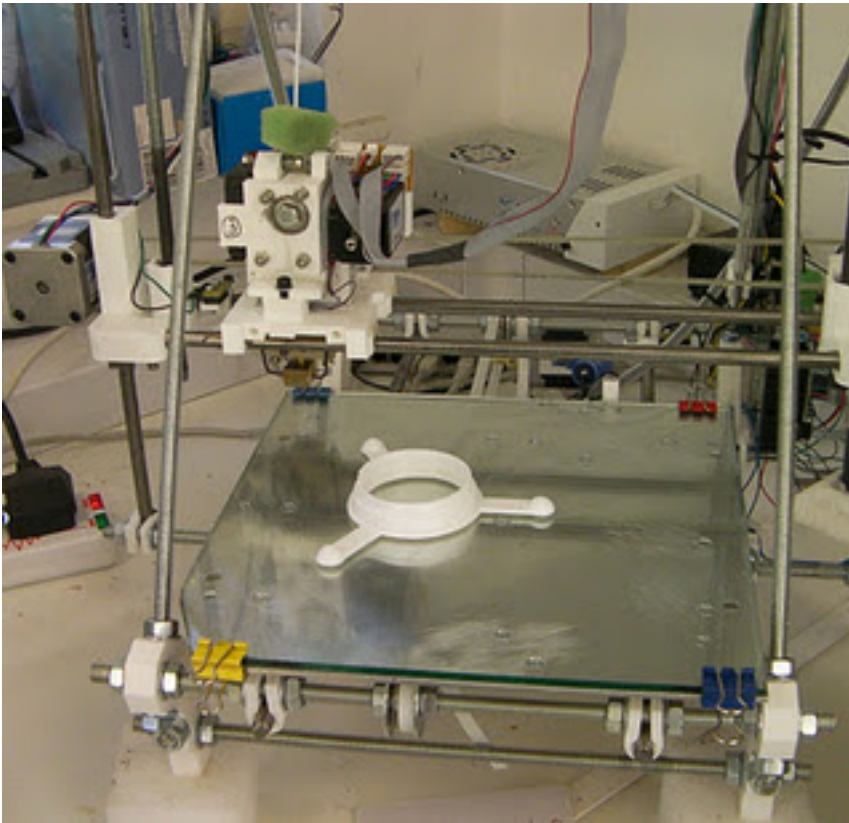

I downloaded Rupert Rawnsley's OpenSCAD Horizontal Spool Holder from Thingiverse and printed it on one of my Prusa Mendels. Nothing unusual about that.

Except that at no point in the making-chain from Thingiverse to the finished printed object was an STL file used to do the calculations. The spool holder was printed directly from OpenSCAD's CSG representation.

Printing directly from CSG is much more robust than using the flakey (literally) STL file format. A CSG file can be wrong - we can all make mistakes - but, unlike STL, it always represents an unambiguous solid.

It should also be faster. I'll do some timings and post them later. Finally, it should allow us easily to do fancy things like filling solids with scalar and vector fields representing build parameters, so you can have an object that is flexible (and/or green) at one end and rigid (and/or blue) at the other.

I built a simple CSG modeller into the RepRap Java Host Software. I added a parser that directly

reads the CSG generated by OpenSCAD into it. (The software still uses the STL too, but just as a bunch of triangles for display on the screen; STL takes no part in the build process.) At the moment the supported OpenSCAD primitives are cubes, cylinders (including frustums and cones), and spheres. I will add extruded polygons, extruded imported DXFs, polyhedra, and imported STL files later (in that order, which is also the order of difficulty of doing them...). Note that the final one of those will implicitly (there's a mathematical joke there somewhere) allow any STL file to be converted to CSG.

Just like the CSG processor at the heart of OpenSCAD, the software is essentially a re-implementation of my old friend John Woodwark's DORA CSG modeller (Divided Object Ray-tracing Algorithm) from the early 1980s ([see here](#)).

For instructions on how to use all this, [follow this link](#)...

Stop Press:

Marius has just upgraded OpenSCAD to make things even easier. The OpenSCAD Github master now has:

```
$ openscad examples/example001.scad -o out.csg..or Design->Export as CSG
```

Prusa Iteration 2

Friday, 11th November 2011 by prusajr

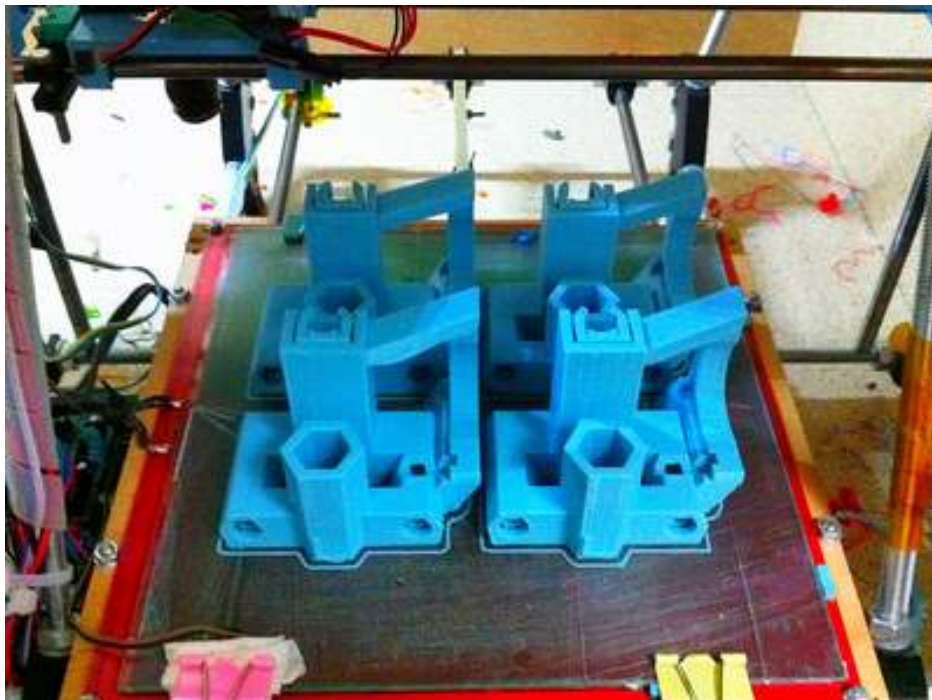

When I have RepRap presentation I always say that I update my printer almost every week. If you watch my GitHub Repository, you must be puzzled now. It's a long time since my last commit there. But when you look closer you would find out that the printer lived in Felt branch last few months. It evolved into something much slicker, smoother and sexier. While keeping it's workhorse spirit.

It was already build on many workshops and it speeds up the build by many hours! Forget glueing the bushings, that was soo 2010.

Iteration 2 is the younger, cooler brother of Prusa. It has 111111 changes and it's 63 times better :-)
)

Print NOW!

I quickly pick some important changes of Iteration 2

1) Push fit

Where it is possible parts are just pushed in without any fastener needed :-)

2) Bushings

You have possibility to use Igus professional bushings, brass tube, felt, pla printed bushing or even printer lm8uu alternatives.

All bushings are simply snap in mounted, you can easily maintain your printer!

When you need your printer quick you can always find one of those at home :-)

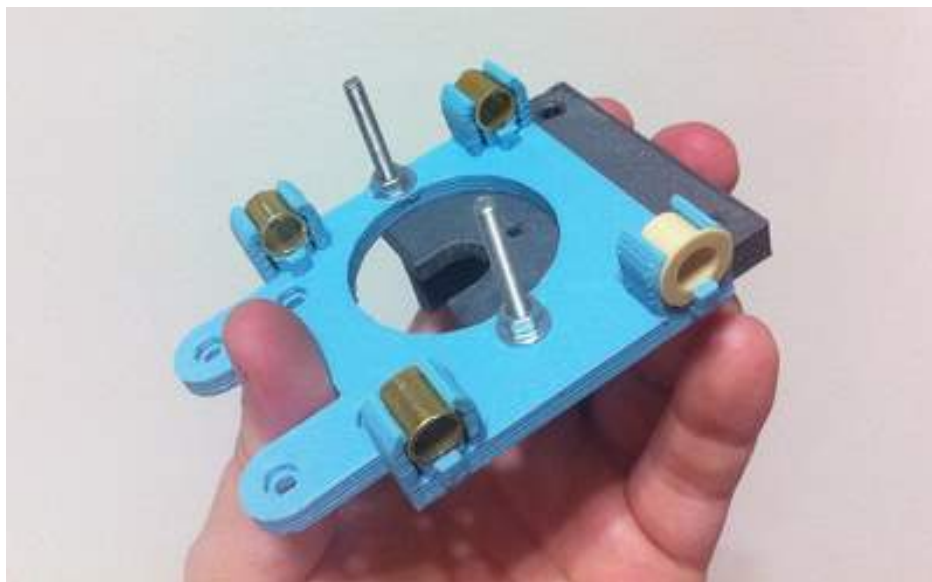

3) No SAE version.

Are you sad?? You shouldn't be, parts will work with both metric and imperial fasteners.

Get M3 for small fasteners (you need them for NEMA 17s anyway) or #4 imperial ones if you really need to.

5/16 rods will work in place of M8 without any change!

4) LM8UU

You asked for it, so you got it! :-)

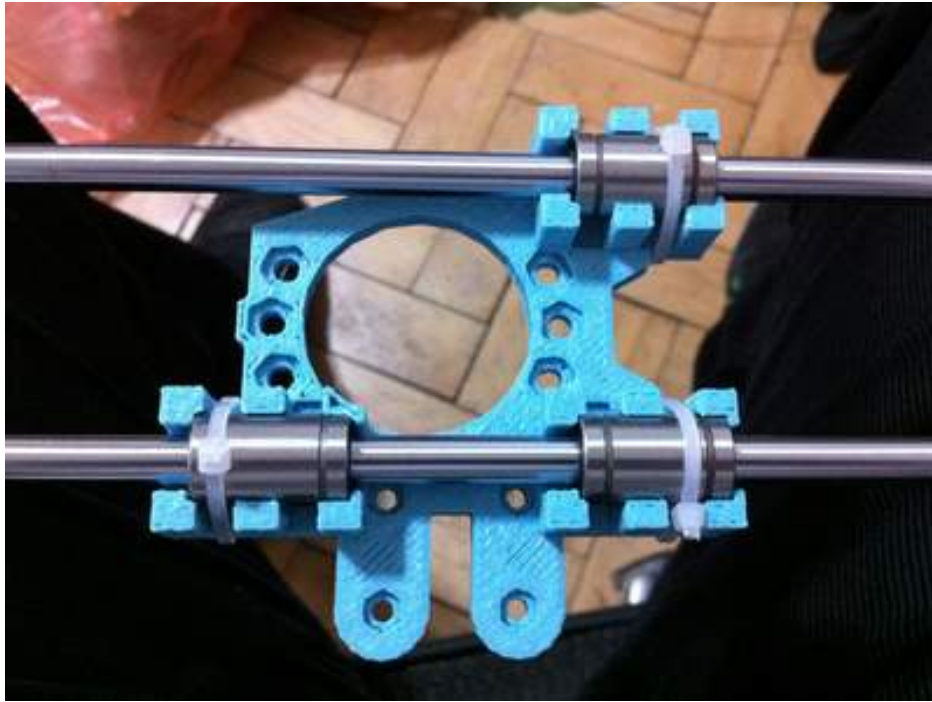

5) Less tools needed

All M3 nuts have nut traps. I've done workshop where everyone had only one Philips screw driver and two wrenches for M8 nuts!

No jigs or measurement during print! Rods are exactly length you need from end to end.



6) One plate bed

That's kinda hack. PCB heatbed actually works as second plate.

But it needs no leveling at all and frees lots of space under Y axis for electronics or PSU to make tidy, cute printer!



7) Better belts

I use T2.5 belts instead of T5 for a long time, and it affects the quality more significantly than any Im8uu would ever do. Now it's official suggestion, get GT2 or T2.5 belts and machined pulleys! Be professional!



8) Better documentation (future)

I get best team to help me manufacture the new documentation!

Kliment and Garry Hodgson (you many know him form Prusa Mendel Visual instructions).

Expect to see it pretty soon! And fully done in ThingDOC!

Watch out my [GitHub](#), [Flickr](#) and [Twitter](#) to get latest updates!

Playing Fast & Loose

Wednesday, 16th November 2011 by Vik Olliver

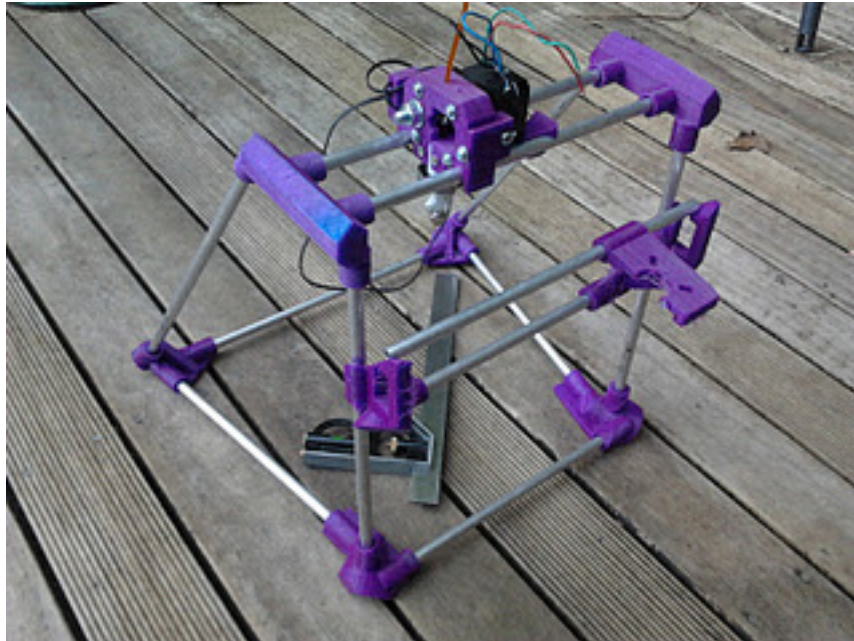

Above is an Orca-style RepRap frame using 10.8mm round extruded aluminium tube simply whacked into printed sockets with a large mallet. The result is slightly under tension on the back bracing which holds the whole thing very securely together with no fasteners.

This is much lighter and simpler than traditional prototyping-style construction with adjustable threaded rods all over. It has the benefit that the smooth rods can be used as axis guides as well as support structure. The Orca-style dihedral distributes load and prevents swaying from side to side.

It's crowned with a one-piece extruder that includes all the guides, clamps and sliders in a single printed piece. It could still be easier to assemble though.

This is really an initial space model - I've not put much work into the brackets and Z lift mechanism yet. Didn't want to have to rework everything if it wasn't stable! I'll cause controversy with the Z axis next :)

Vik :v)

Reprap Prusa Iteration 2 Build Event in Cologne Germany in December

Sunday, 27th November 2011 by Neil Underwood

(Posted at request of Kliment Yanev, if you are having a RepRap Build Party, RepRap.org would love to support you by announcing your event on the main blog.)

A reprap build workshop is going to take place in Cologne, Germany on the first weekend of December (3-4.12). Ten groups will have the opportunity to build their very own 3d printer, get it working, and take it home with them.

Under the guidance of Josef Prusa, Kliment Yanev and Ruben Lubbes, we'll build ten printers of the latest Prusa Iteration 2 variety. More info on Prusa iteration 2 at [Prusa Iteration 2](#)

After building the printers, we'll look at control and design software, basic troubleshooting, and where to get designs, ideas, and help. At the end of the workshop, every participant or group will go home with a working printer.

Here is a video of an earlier workshop organized by the same team:

Workshop data:

Time: 3rd and 4th of December 2011, from 10.00h to 19.00h on both days. Impatient builders may continue past 19h on Saturday if they wish to, but that should not be necessary.

Location: Coworking Space Gasmotorenfabrik, 3rd floor, Deutz-Milheimer Str. 129, 51063 Cologne, Germany

Price: 850,- per printer. The number of participants per printer is not limited (though 2-3 is ideal).

Signup by email, [kliment.yanev @ gmail.com](mailto:kliment.yanev@gmail.com)

Included in the course price are all the parts as well as some plastic print material. The electronics, hotend, and cable terminations (the boring bits that eat a lot of time) will be done for you in advance.

Required tools:

- -Set of hexagonal keys (allen keys) including small sizes
- -Screwdriver set
- -Wrenches in sizes 13 (ideally two pieces), 7 and 5.5
- -Electronics pliers set (at least needle nose and side cutters)
- -Tweezers
- -8mm round file

Note that we have all these tools available onsite, but not enough for everyone. Please bring your own set of tools if at all possible.

Photos of past build events are available at <http://ikmaak.nl>

Around the RepRap Community 11/28/2011

Monday, 28th November 2011 by Neil Underwood

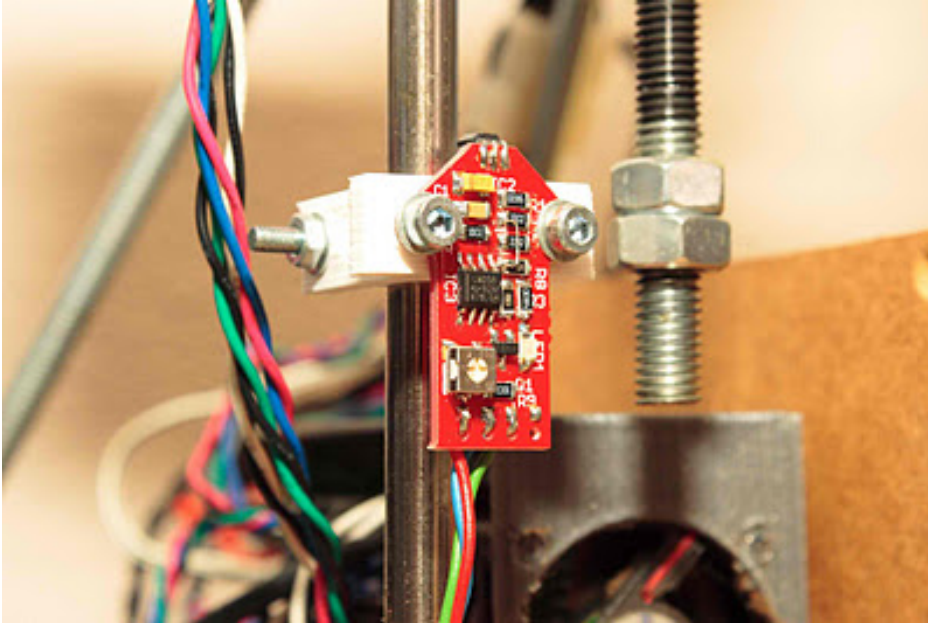

Credit Photo Tomcee

Hall-O effect Endstops

Hall-O effect sensors have an advantage over both mechanical endstops and optos because it senses distance instead of waiting for contact, so it should never wear out like a mechanical endstop, and not be affected by lighting changes in the room like an opto. Of course this is the open source board upload by Jos to the RepRap Wiki. Being open hardware you can get the eagle files off the wiki or buy them from Ruben-Ikmaak for 9 euro with cables and magnets included at his website.

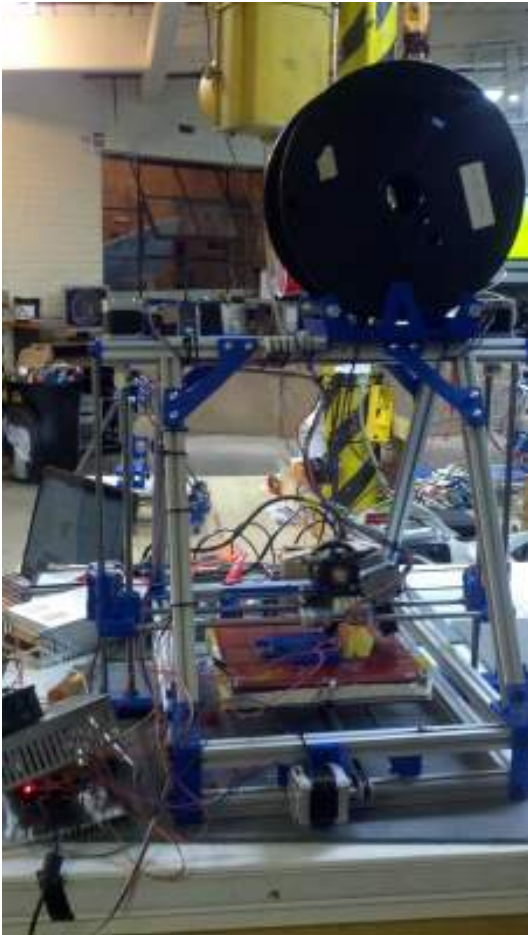

(Credit Red of Hackerspace Charlotte (NC_USA))

MendelMax

MendelMax is a new Open Source RepRap



3d printer designed by Maxbots and based on the Prusa Mendel. It is a true reRap, using printed brackets, but instead of using threaded rod for the structural elements it uses inexpensive aluminum extrusions. This gives a huge increase in rigidity for a minimal extra cost (Self sourcing will cost about \$80 more than a standard Prusa when purchased from the recommended suppliers). The required extrusions are available world wide from a variety of suppliers.

MendelMax costs a bit more, weighs a good bit more, but the frame is much physically tougher, and looks 500 times sexier. I have yet to see any parts for MendelMax go on Ebay/Emakershop, but Lulzbot is selling the parts. They also took a pretty cool pic showing how strong the frame is.



credit Lulzbot/Alphobjects

One other must share image, what happens when you mix Makerslide, & MendelMax

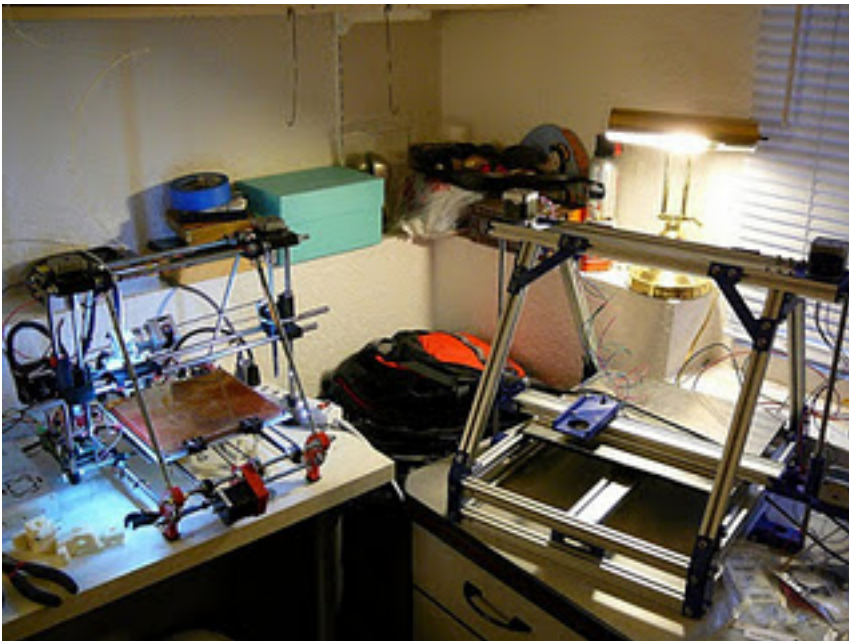

Credit Nick Wilson
WINNING!

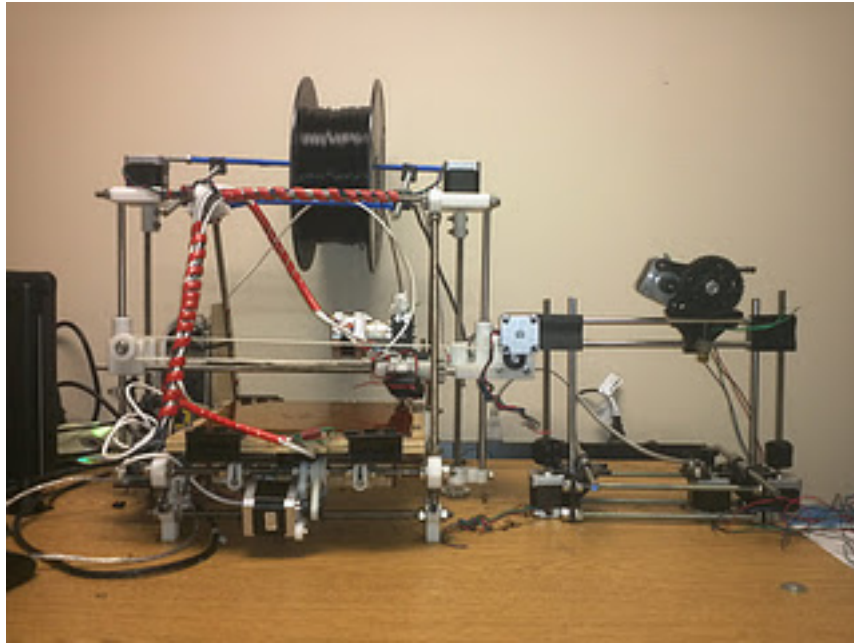

Credit Neil Underwood at Fablocker Hackerspace in Winston-Salem NC
Printrbot

Printrbot is a smaller scale Reprap design, very similar in size to the Emaker Huxley, but the standard "Mendel" design has been dropped in favor of a very simplified base frame and a floating y stage (The Y axis is supported only in the middle). The core team of Printrbot were nice enough to let me have the files pre-release (I think release will be in late December) to help out in the Openscad conversion.

As you can see, I did not get the chance to finish the bot over the weekend, so I hate to review it. Plan is to have review of the bot after I get a 1st print (should be later this week (I hope)). But I can tell you they are for real, and the parts will go together into a functional machine. How well it prints in the real world, and whether the Axis's are as robust as Prusa, I will fill you in on that later.

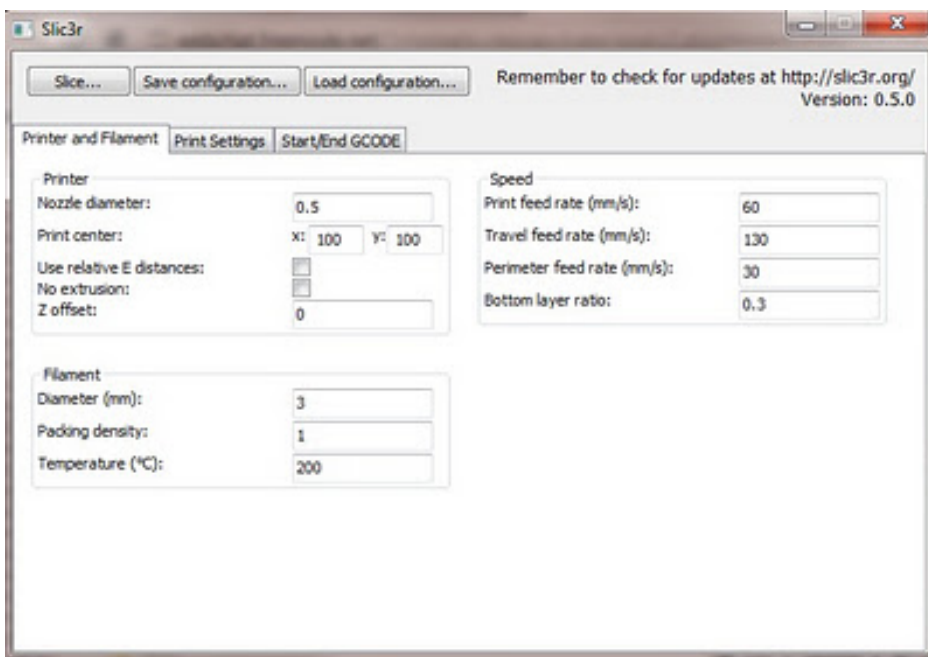

Slic3r

For the last 3 weeks now my go to Gcode generation program has been Slic3r (Found very few things it does not slice, but if it does not I just use Sfact). This slicing engine is a complete ground up rethink of Gcode generation, and honestly I have never had anything that is this easy to set up. Only things you need to give it are nozzle & filament diameter, packing density (if your E step/mm is dead on this should be 1), your requested extrusion width/height, and your set up. Generating Gcode is about 10 times faster on big things and 2-3 times faster on small things. It's definitely worth checking out.

Quality - Open Source for the Win (Part Deux)

Tuesday, 29th November 2011 by Adrian Bowyer



A short while ago Neil [posted here](#) about the way RepRap 3D print quality is starting to knock spots off the proprietary competition.

Well. This blog is not the place for RepRap spinoff company Ra Ra, so I have left it until [our sales campaign here](#) is just about over before making this post. (And no - I couldn't manage to resist abusing my position and including the link.)

Jean-Marc just printed [Misguided's Screw Cup from Thingiverse](#) (above) on one of our RepRapPro Huxleys in ABS. We used a non-standard 0.3mm nozzle (standard is 0.5mm) and a layer height of 0.1mm. It took a while under those conditions, of course - 5 hours.

But check out this surface finish under the microscope:



The line is a 60-micron human hair (selflessly donated by Christine Bowyer under only mild protest; as those aware of my appearance will know, I am incapable of providing such a sample myself).

We think that the quality we're getting is rather good...

Solving a nagging question about print adhesion

Friday, 16th December 2011 by Forrest Higgs

Unlike most of you, I don't use an electrically heated print surface. Some time ago I bought a Rapman 3.1, which used an acrylic 3 mm print table. I soon discovered that 3 mm was far too thin and quickly warped beyond use. Switching to 10 mm solved that problem.

After a long time of successful prints, I noticed that with winter causing colder temperatures in the print room I was having more and more trouble getting my prints to stick to the acrylic. I tried cleaning it and sanding it with little avail. Electrically heated print tables were just coming available but insofar as printing was concerned, I thought that things were already complicated enough without adding that sort of equipment to my Rapman.

I had an IR heat lamp in the lab, detritus of another experiment, and discovered that using it on a tripod to raise the temperature of the acrylic print table above 40 degrees Celsius measured with a non-contact IR thermometer gave me consistent adhesion. I soon discovered that I could turn off the IR lamp after 4-5 print layers with no ill effects. It was not needed for the rest of the print.

The rig looked a bit like this...

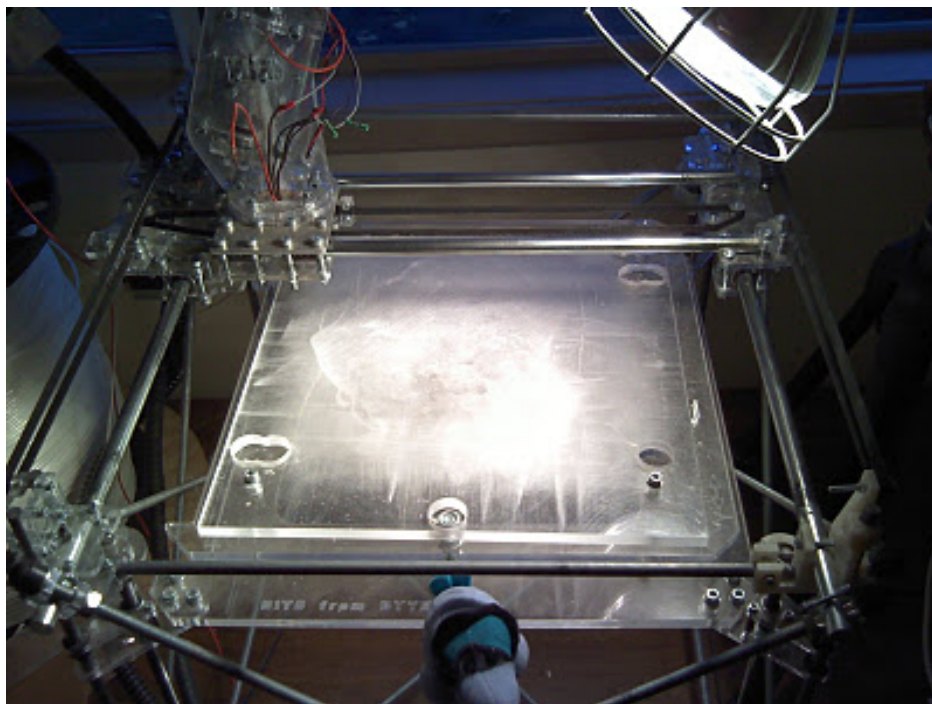

Note that the lamp is placed at a 45 degree angle to the acrylic print table.

I soon noticed that adhesion at the near side of the print table was much less firm than that at the back and less firm at the left side than the right. I attributed this to various things, uneven heating being one of the possibilities. While the left/right difference made sense the front/back difference didn't seem as the IR lamp was aligned with the left/right axis.

Cranking the terminal heating temperature before starting a print to about 50 degrees solved most of the problem for the center of the table and I was able to print along the front/back axis with reliable success. Unfortunately, the back side of the print area seemed to have the print pad melting into the acrylic while the front side would separate easily.

It made no sense. I thought for a while that it had something to do with the acrylic plate and rotated it with no effect. Swapping ends and sides always left the back side of the print table very firmly attached to the print pad. While that wasn't a horrible situation it was annoying, because it meant that processing the printed objects after separation became more time consuming.



A few weeks ago, I purchased a FLIR E30 thermal imaging camera with the intention of learning more about what was happening with prints as they were being laid down, the ultimate goal being building in advanced heuristics into my Slice and Dice app which converts STL files into Gcode. I also had hopes about eventually doing some research into what actually happens thermally with

extruder hot ends with the notion that I might be able to design a better one.

Yesterday, the E30 arrived and I decided that a good beginning exercise might be to look at the distribution of heat on my acrylic print table when I used the IR lamp in its standard configuration to heat it. The results were quite unexpected.

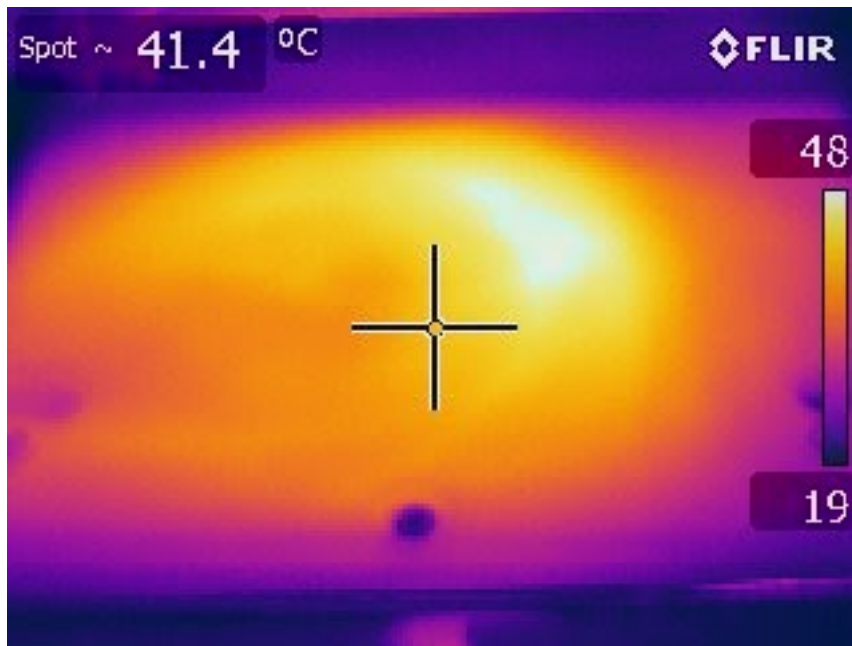

>

The lamp put down a marked hot spot at the upper right rather than at the right as I expected. The upper right was exactly where I had the most trouble with print pad melting. Obviously, the IR lamp did not give even heating when tilted but overheated in on the upper right.

This was nasty. I had previously thought about using several smaller IR lamps at the corners of the Sampo printer that I have been developing. If the smaller lamps behaved like my single, large one, however, this might not be a good idea at all.

I then got to thinking about how IR lamps are actually used in food heating cabinets. They are almost always placed point straight down. I rearranged my tripod to place the lamp almost vertically over the acrylic print table.

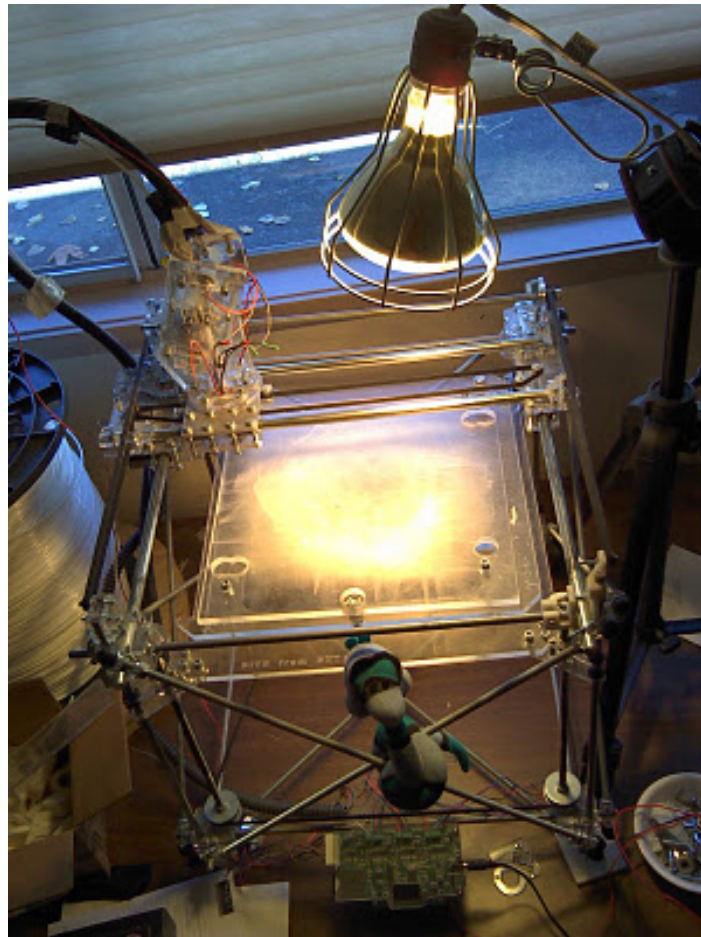

That sorted out the temperature distribution problem...

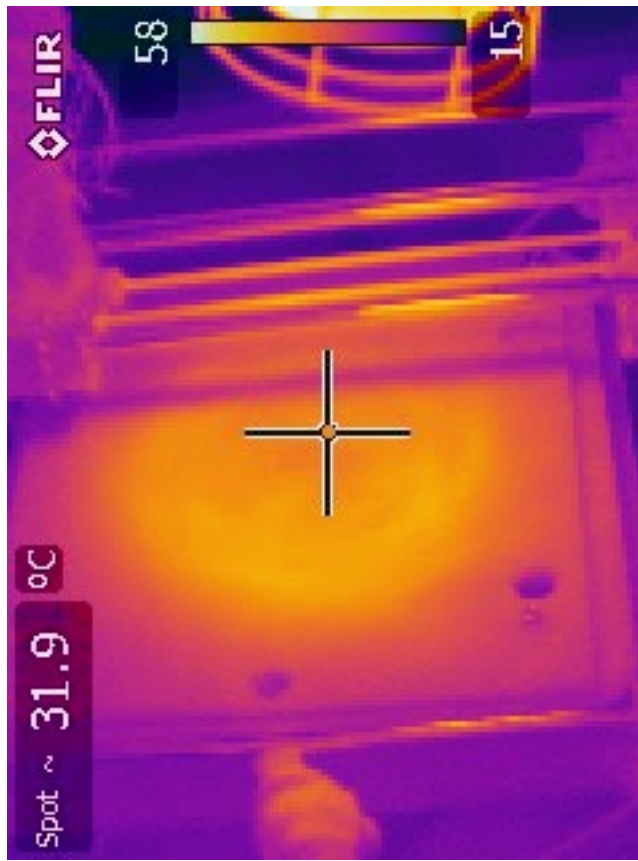

0.01 Layer Height on a Prusa Mendel

Tuesday, 27th December 2011 by Neil Underwood

After a very long time sticking with Sprinter Firmware and Sfact for my Gcode generator I decided to upgrade a little bit. I moved to Marlin Firmware (Which has become all the rage in the RepRap IRC Channel), and Slic3r for Gcode generation (Does same job as Skeinforge).

Marlin is a little more confusing to set up than Sprinter (Configuration.h is modified by commenting in and out things instead of setting variables). Only real change I have found with Marlin is acceleration has a different sound to it, and my rounded parts are a bit more round.

Slic3r is amazing. STL that would take 30-40 minutes to convert to Gcode it can process in 2-4 minutes (The .01 layer height woman only took around 8 minutes to slice and would have been over an hour with sfact/skeinforge). Also, setup is dead simple. Just enter your nozzle size, filament diameter, and extrusion multiplier if you e/steps are a bit off and your good for a 1st print. Only downside of Slic3r is it does not support single wall prints, or support material yet (But if you like to play with code I am sure Sound would like the help on hit Github, or the slic3r IRC).



For ultrafine printing with Slic3r the only parameter you change is the layer height, So both the

failed Yoda at .04 and Pink Panther at .01 only required a change from .25 layer height to .04/.01 respectfully. The Yoda failed because at such fine layer heights I discovered that bridging is completely broken, so any small break in the outer skin of a part will never get fixed by the bridging of the next layer and just get worse over time.

After the failure of the Yoda I needed to find a model that looked nice in fine printing, and had no bridging, of course my mind went straight from Yoda to the naked female form.... don't ask.

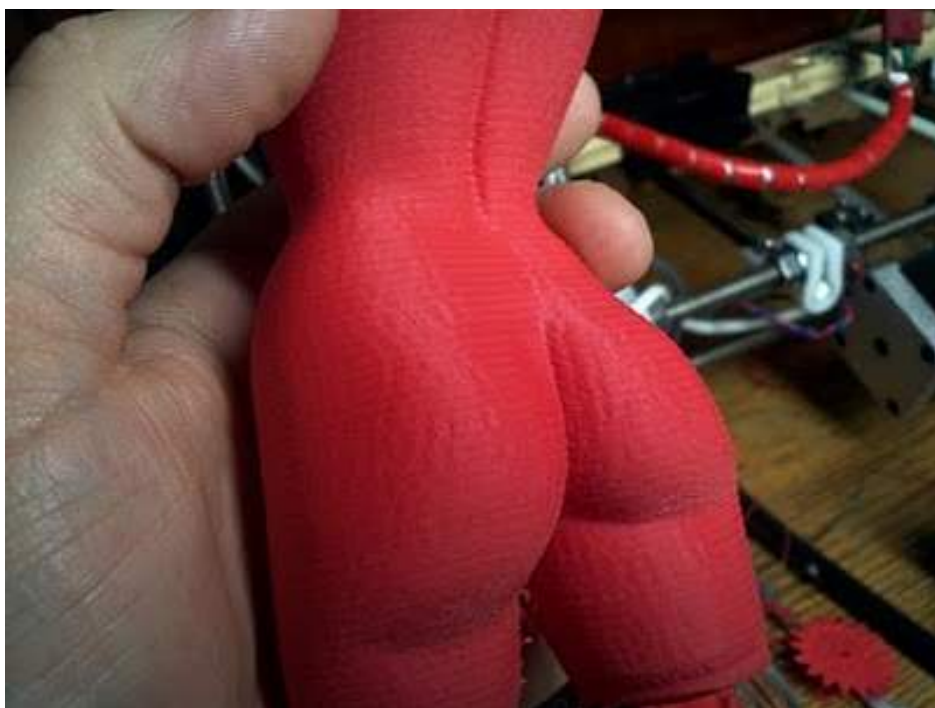

Printing at this layer height really shows off that I need to upgrade from standard Prusa Z couplings to a Nophead or aluminum Z coupling, but beyond that the print turned out wonderful. at .01 layer height as you can imagine the 1st 2 layers where a bit sketchy, took me 1 hour to get the bed THAT level (1/25 your normal layer height really shows you how not level your bed is).

From talking to some friends in the RepRap IRC I think that with 3mm filament .01 layer height will not be possible, just because the feed rate would actually be too low, and the retractions would cause you to repeatedly go over the same piece of plastic, causing the plastic to shred. But if your running 1.7 plastic and Slic3r repeating this stunt should not be that hard. Hope you have a lot of time, it took 9 hours to get of to the upper chest on this print before I ran out of Z. :)

Equipment/Software used:

Makergear Prusa Hybrid

1.7 Red ABS Plastic from Ultimachine

Marlin Firmware v1

Latest experimental branch Pronterface in Linux

Slic3r GCode Generator v5.7 (Fully stock settings besides layer height at .01)

3 perimeters, 0 infill