

PiBot For Repeater V1.4-2

Design by: pxl

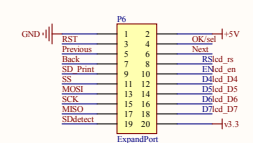
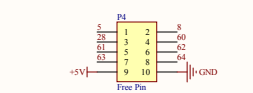
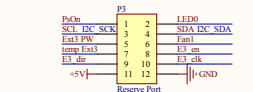
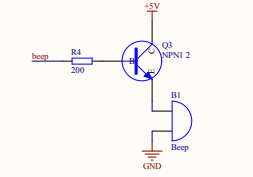
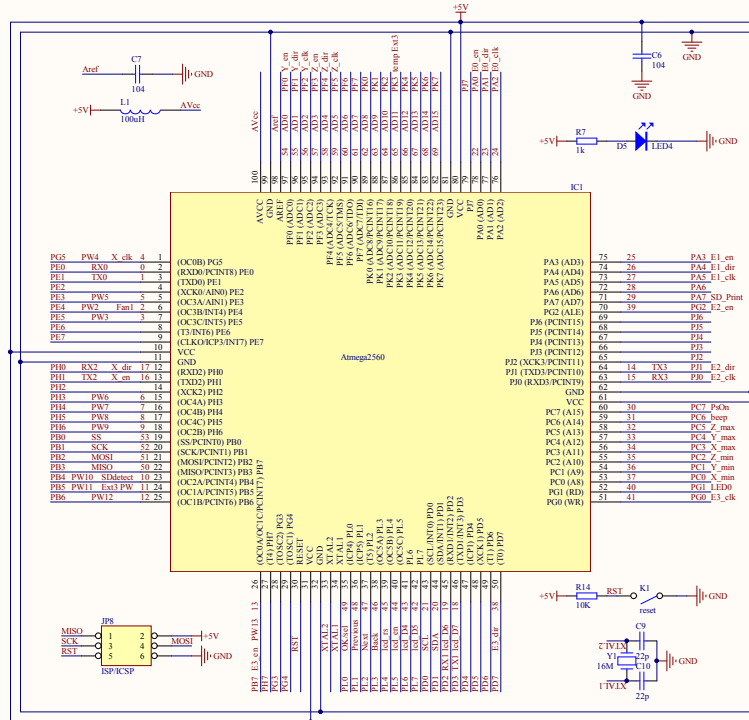
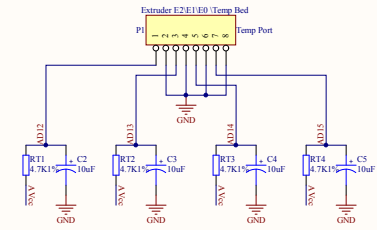
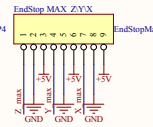
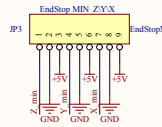
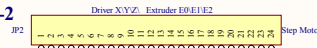
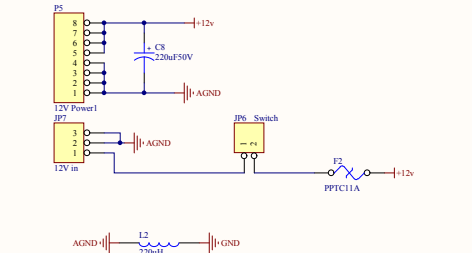
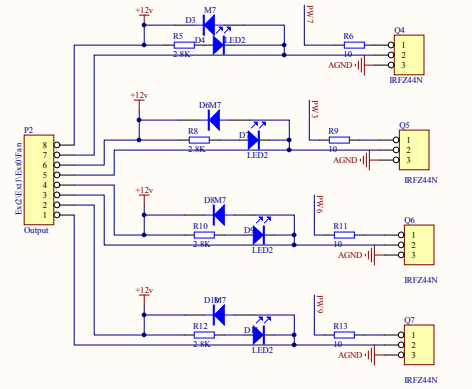
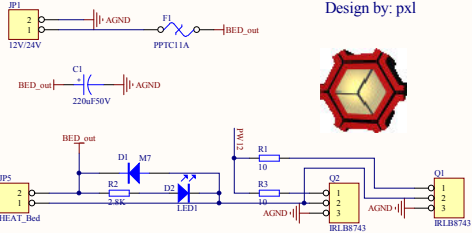

PiBot For Repeater V1.4-2

Design by: pxl

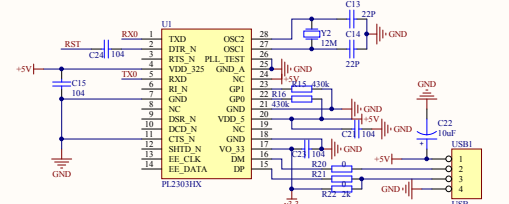
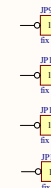

Title		
Size	Number	Revision
C		
Date	2011/06/31	Sheet 1 of 1
File	E:\Pi-second-part_V1.4-2\ShkBotV1.4-2	Sheet 1 of 1