

SAV Mk-I - 3D printer electronics

3D printer electronics from the Clone Wars Project
http://reprap.org/wiki/Clone_wars

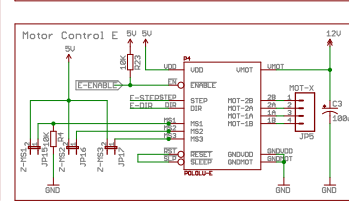
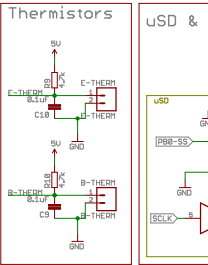
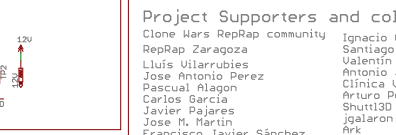
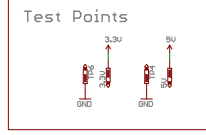
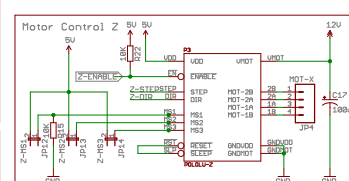
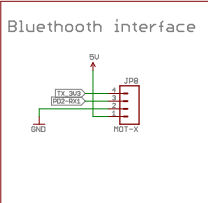
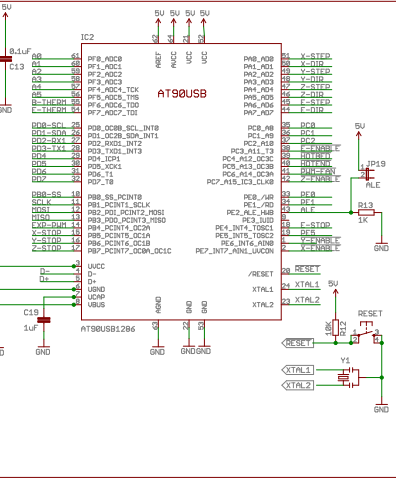
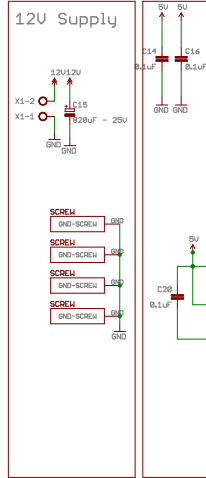
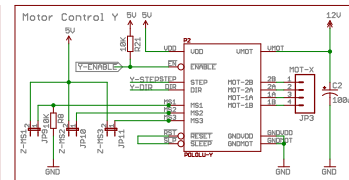
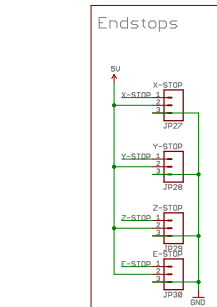
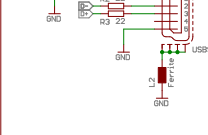
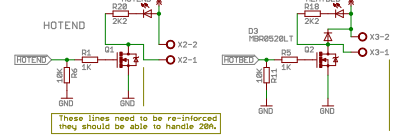
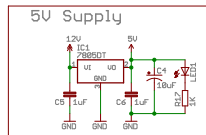
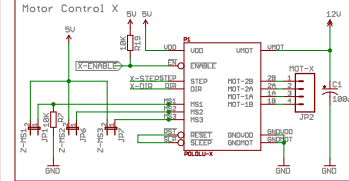
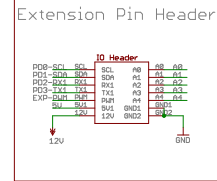
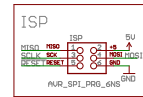
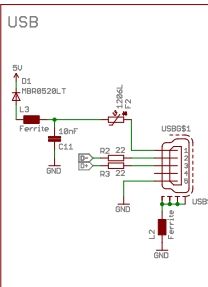
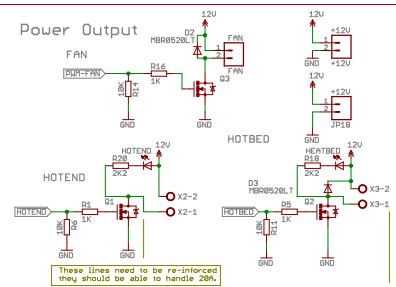
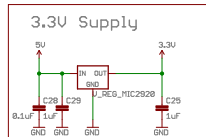

Project Supporters and collaborators
 Clone Wars RepRap community
 Reprap Zaragoza
 Luis Ullarrubies
 Jose Antonio Perez
 Pascual Alagon
 Carlos Garcia
 Javier Pajares
 Jose M. Martin
 Francisco Javier Sánchez
 Antonio Javier Lopez
 Manuel Palacios
 Juan Manuel Amuedo - CoE
 Adri
 Chema Muñoz
 Luis Macias

Ignacio Giniunas
 Santiago Lopez
 Valentin Cancelas
 Antonio Javier Lucas
 Clinica Veterinaria Noso Can
 Arturo Pueyo
 Shutt13D
 jgalaron
 Ark
 Fib

Special thanks to Andreu

THIS DESIGN IS PROVIDED BY THE COPYRIGHT HOLDERS AND CONTRIBUTORS "AS IS" AND ANY EXPRESS OR IMPLIED WARRANTIES, INCLUDING, BUT NOT LIMITED TO, THE IMPLIED WARRANTIES OF MERCHANTABILITY AND FITNESS FOR A PARTICULAR PURPOSE ARE DISCLAIMED. IN NO EVENT SHALL THE AUTHOR BE LIABLE FOR ANY DIRECT, INDIRECT, INCIDENTAL, SPECIAL, EXEMPLARY, OR CONSEQUENTIAL DAMAGES (INCLUDING, BUT NOT LIMITED TO, PROCUREMENT OF SUBSTITUTE GOODS OR SERVICES; LOSS OF USE, DATA, PERSONAL OR MATERIAL DAMAGE; PROFITS OR BUSINESS INTERRUPTION) HOWEVER CAUSED AND ON ANY THEORY OF LIABILITY, WHETHER IN CONTRACT, STRICT LIABILITY, OR TORT (INCLUDING NEGLIGENCE OR OTHERWISE) ARISING IN ANY WAY OUT OF THE USE OF THIS DESIGN, EVEN IF ADVISED OF THE POSSIBILITY OF SUCH DAMAGE.

Released under the Creative Commons Attribution Share-Alike 3.0 License
<http://creativecommons.org/licenses/by-sa/3.0/>

Design based on the Teensylu form factor and pinouts.
 SAV Mk-I by im - halfpartida

SAV Mk-I
 TITLE: SAV MK-I
 Document Number: **electroFUN LTD (www.electrofund.com)**
 Date: 12/24/2013 8:22:16 PM

REV: **B**
 Sheet: 1/1